



**ELECTROCHIRURGIE**  
***ELECTROSURGERY***

L A N D A N G E R

**Pour tous renseignements, devis et commandes :**  
For all information, quotes and orders :  
Para cualquier información, presupuestos y pedidos :



Tel. (France) : 0325021010  
Tel. (Export) : +33 325021010  
Du lundi au vendredi - Monday to friday - Del lunes al viernes  
De 8 heures à 18 heures - From 8:00 am to 6:00 pm (non stop) - De las 8.00 por la mañana a las 6.00 por la tarde



Fax (France) : 0325021020  
Fax (Export) : +33 325021020



France : [contact@landanger.com](mailto:contact@landanger.com)  
Export : [export@landanger.com](mailto:export@landanger.com)



**LANDANGER**  
ZI la Vendue  
BP 2152 - 52906 Chaumont cedex 9  
FRANCE

[www.landanger.com](http://www.landanger.com)

Contact :

---

---

---

---

---

---

# LANDANGER

---

Notre passion,  
notre histoire,  
créent  
la différence.

*Our passion, our history, make the difference - Nuestra pasión, nuestra historia, creen la diferencia*



## Table des Matières - Table of contents - Índice

### Pinces bipolaires, standards - Bipolar forceps, Standard - Pinzas bipolares, estándares

Fines  
Fine  
Finas



Droites  
Straight  
Rectas

Page - 4



Coudées  
Angled  
Acodadas

Page - 5



Baïonnette droite  
Bayonet straight  
Bayoneta recta



Baïonnette coudée  
Bayonet angled  
Bayoneta acodada

Page - 7



Diverses  
Miscellaneous  
Diversas

Page - 8



Fines, non isolées  
Fine, uninsulated  
Finas, sin aislar



Avec irrigation, droites  
With irrigation, straight  
Con irrigación, rectas

Page - 10



Avec irrigation, baïonnette  
With irrigation, bayonet  
Con irrigación, bayoneta

Page - 10



### Pinces bipolaires non adhésives - No sticking bipolar forceps - Pinzas bipolares no adhesivas

Fines  
Fine  
Finas



Droites et coudées  
Straight and angled  
Rectas y acodadas

Page - 12



Baïonnette droite  
Bayonet straight  
Bayoneta recta



Baïonnette coudée  
Bayonet angled  
Bayoneta acodada

Page - 14



### Ciseaux - Scissors - Tijeras

Ciseaux bipolaires BiTech  
BiTech bipolar scissors  
Tijeras bipolares BiTech



Ciseaux-pinces bipolaires  
Bipolar forceps-scissors  
Pinzas-tijeras bipolares

Page - 17



### Pinces monopolaires- Monopolar forceps - Pinzas monopolares

Avec connecteur  
With plug  
Con enchufe



Sans connecteur  
Without plug  
Sin enchufe

Page - 20



Avec connecteur  
With plug  
Con enchufe

Page - 21



### Câbles - Cables - Cables

Câbles bipolaires  
Bipolar cables  
Cables bipolares



Câbles monopolaires  
Monopolar cables  
Cables monopolares

Page - 24-25



### Électrodes - Electrodes - Electroodos

Neutres réutilisables  
Reusable neutral  
Neutros reutilizables



Neutres à usage unique  
Disposable neutral  
Neutros desechables

Page - 27



Page - 26

## Index

Références Codes	Page Page	Références Codes	Page Page	Références Codes	Page Page	Références Codes	Page Page
Referencias	Página	Referencias	Página	Referencias	Página	Referencias	Página
HF0100010	22	HF0100165	23	HF0522200	12	HF1020201	10
HF0100011	22	HF0100189	23	HF0522201	12	HF1020202	10
HF0100012	22	HF0100192	23	HF0522202	12	HF1020204	10
HF0100013	22	HF0100193	23	HF0522206	12	HF1020301	10
HF0100014	24	HF0100195	23	HF0522300	13	HF1020303	10
HF0100016	24	HF0100196	23	HF0522301	13	HF1020304	10
HF0100017	22	HF0100197	23	HF0522302	13	HF1022301	10
HF0100018	22	HF0100198	23	HF0522306	13	HF1022303	10
HF0100019	22	HF0100199	23	HF0522331	14	HF1022304	10
HF0100020	22	HF0100200	23	HF0522341	14	HF1118201	10
HF0100021	22	HF0100201	23	HF0524300	13	HF1118202	10
HF0100022	22	HF0100215	24	HF0524301	13	HF1118204	10
HF0100023	22	HF0100219	22	HF0524302	13	HF1118301	10
HF0100025	22	HF0100220	25	HF0524306	13	HF1118303	10
HF0100027	22	HF0100221	24	HF0611100	11	HF1118304	10
HF0100029	22	HF0100230	25	HF0611101	11	HF1120201	10
HF0100031	24	HF0100240	24	HF0611103	11	HF1120202	10
HF0100033	22	HF0100241	24	HF0611110	11	HF1120204	10
HF0100034	22	HF0100242	24	HF0611111	11	HF1120301	10
HF0100035	22	HF0100243	24	HF0611113	11	HF1120303	10
HF0100036	22	HF0100297	23	HF0615200	12	HF1120304	10
HF0100037	22	HF0100298	23	HF0615201	12	HF1122301	10
HF0100038	22	HF0100299	23	HF0615202	12	HF1122303	10
HF0100039	22	HF0100300	23	HF0615206	12	HF1122304	10
HF0100040	22	HF0100314	24	HF0615210	12	HF1507000	3
HF0100041	22	HF0100315	25	HF0615211	12	HF1507001	3
HF0100043	22	HF0100316	24	HF0615212	12	HF1507010	3
HF0100045	22	HF0100317	25	HF0615216	12	HF1507011	3
HF0100046	22	HF0100318	25	HF0618200	12	HF1511100	3
HF0100047	22	HF0100319	25	HF0618201	12	HF1511101	3
HF0100048	22	HF0100320	24	HF0618202	12	HF1511103	3
HF0100051	22	HF0100330	24	HF0618206	12	HF1511110	3
HF0100052	22	HF0100331	24	HF0618210	12	HF1511111	3
HF0100053	22	HF0100360	24	HF0618211	12	HF1511113	3
HF0100054	22	HF0511100	11	HF0618212	12	HF1511120	3
HF0100055	22	HF0511101	11	HF0618216	12	HF1511121	3
HF0100056	22	HF0511103	11	HF0618300	13	HF1512601	8
HF0100058	22	HF0511110	11	HF0618301	13	HF1515200	4
HF0100059	22	HF0511111	11	HF0618302	13	HF1515201	4
HF0100063	22	HF0511113	11	HF0618306	13	HF1515202	4
HF0100065	22	HF0515200	12	HF0620200	12	HF1515204	4
HF0100073	22	HF0515201	12	HF0620201	12	HF1515210	5
HF0100075	22	HF0515202	12	HF0620202	12	HF1515211	5
HF0100081	23	HF0515206	12	HF0620206	12	HF1515212	5
HF0100082	23	HF0515210	12	HF0620300	13	HF1517400	8
HF0100083	23	HF0515211	12	HF0620301	13	HF1517401	8
HF0100084	23	HF0515212	12	HF0620302	13	HF1517402	8
HF0100085	23	HF0515216	12	HF0620306	13	HF1518200	4
HF0100086	23	HF0518200	12	HF0620331	14	HF1518201	4
HF0100087	23	HF0518201	12	HF0620341	14	HF1518202	4
HF0100088	23	HF0518202	12	HF0622200	12	HF1518204	4
HF0100089	23	HF0518206	12	HF0622201	12	HF1518210	5
HF0100092	23	HF0518210	12	HF0622202	12	HF1518211	5
HF0100093	23	HF0518211	12	HF0622206	12	HF1518212	5
HF0100094	23	HF0518212	12	HF0622300	13	HF1518300	6
HF0100095	23	HF0518216	12	HF0622301	13	HF1518301	6
HF0100096	23	HF0518300	13	HF0622302	13	HF1518302	6
HF0100097	23	HF0518301	13	HF0622306	13	HF1518330	7
HF0100098	23	HF0518302	13	HF0622331	14	HF1518331	7
HF0100114	24	HF0518306	13	HF0622341	14	HF1518332	7
HF0100115	24	HF0520200	12	HF0624300	13	HF1518340	7
HF0100121	23	HF0520201	12	HF0624301	13	HF1518341	7
HF0100125	23	HF0520202	12	HF0624302	13	HF1518342	7
HF0100127	23	HF0520206	12	HF0624306	13	HF1520200	4
HF0100130	23	HF0520300	13	HF1018201	10	HF1520201	4
HF0100140	23	HF0520301	13	HF1018202	10	HF1520202	4
HF0100150	23	HF0520302	13	HF1018204	10	HF1520204	4
HF0100153	23	HF0520306	13	HF1018301	10	HF1520210	5
HF0100155	23	HF0520331	14	HF1018303	10	HF1520211	5
HF0100163	23	HF0520341	14	HF1018304	10	HF1520212	5

## Index

Références Codes	Page Page	Références Codes	Page Page	Références Codes	Page Page	Références Codes	Page Page
Referencias	Página	Referencias	Página	Referencias	Página	Referencias	Página
HF1520300	6	HF1611101	3	HF1620342	7	HF5723110	15
HF1520301	6	HF1611110	3	HF1622200	4	HF5723120	16
HF1520302	6	HF1611111	3	HF1622201	4	HF5728110	15
HF1520330	7	HF1611120	3	HF1622202	4	HF5728120	16
HF1520331	7	HF1611121	3	HF1622210	5	HF5791450	17
HF1520332	7	HF1612601	8	HF1622211	5	HF5791451	17
HF1520340	7	HF1615200	4	HF1622212	5	HF5791900	17
HF1520341	7	HF1615201	4	HF1622300	6	HF5791901	17
HF1520342	7	HF1615202	4	HF1622301	6	HF9101050	27
HF1522200	4	HF1615210	5	HF1622302	6	HF9101051	27
HF1522201	4	HF1615211	5	HF1622330	7	HF9101052	27
HF1522202	4	HF1615212	5	HF1622331	7	HF9101053	27
HF1522210	5	HF1617400	8	HF1622332	7	HF9232003	26
HF1522211	5	HF1617401	8	HF1622340	7	HF9232004	26
HF1522212	5	HF1617402	8	HF1622341	7	HF9242003	26
HF1522300	6	HF1618200	4	HF1622342	7	HF9242004	26
HF1522301	6	HF1618201	4	HF1624200	4	HF9602184	21
HF1522302	6	HF1618202	4	HF1624201	4	HF9618110	20
HF1522330	7	HF1618210	5	HF1624202	4	HF9618112	18
HF1522331	7	HF1618211	5	HF1624210	5	HF9618120	20
HF1522332	7	HF1618212	5	HF1624211	5	HF9618122	18
HF1522340	7	HF1618300	6	HF1624212	5	HF9621110	20
HF1522341	7	HF1618301	6	HF1624300	6	HF9621112	18
HF1522342	7	HF1618302	6	HF1624301	6	HF9621120	20
HF1524200	4	HF1618330	7	HF1624302	6	HF9621122	18
HF1524201	4	HF1618331	7	HF1624330	7	HF9621312	18
HF1524202	4	HF1618332	7	HF1624331	7	HF9621322	18
HF1524210	5	HF1618340	7	HF1624332	7	HF9625110	20
HF1524211	5	HF1618341	7	HF1624340	7	HF9625112	18
HF1524212	5	HF1618342	7	HF1624341	7	HF9625120	20
HF1524300	6	HF1620200	4	HF1624342	7	HF9625122	18
HF1524301	6	HF1620201	4	HF1807000	9	HF9630110	20
HF1524302	6	HF1620202	4	HF1807001	9	HF9630112	18
HF1524330	7	HF1620210	5	HF1807010	9	HF9630120	20
HF1524331	7	HF1620211	5	HF1807011	9	HF9630122	18
HF1524332	7	HF1620212	5	HF1811100	9	HF9690002	19
HF1524340	7	HF1620300	6	HF1811101	9	HF9690012	19
HF1524341	7	HF1620301	6	HF1811110	9	HF9690022	19
HF1524342	7	HF1620302	6	HF1811111	9	HF9690032	19
HF1607000	3	HF1620330	7	HF4620212	21	HF9690042	19
HF1607001	3	HF1620331	7	HF5718110	15	HF9714110	20
HF1607010	3	HF1620332	7	HF5718120	16	HF9714112	18
HF1607011	3	HF1620340	7	HF5721110	15	HF9714120	20
HF1611100	3	HF1620341	7	HF5721120	16	HF9714122	18





300 Vp max

McPHERSON



Bijoutier  
Jeweler  
Relojero



Connecteur Plug Enchufe	Largeur des pointes Width of tips Anchura de las puntas	85 mm	85 mm	110 mm	110 mm	110 mm
-------------------------------	---	-------	-------	--------	--------	--------

	0,25 mm	HF1507000	HF1507010	HF1511100	HF1511110	HF1511120
		HF1607000	HF1607010	HF1611100	HF1611110	HF1611120
	0,45 mm	HF1507001	HF1507011	HF1511101	HF1511111	HF1511121
		HF1607001	HF1607011	HF1611101	HF1611111	HF1611121
	1,00 mm	-	-	HF1511103	HF1511113	-

500 Vp max

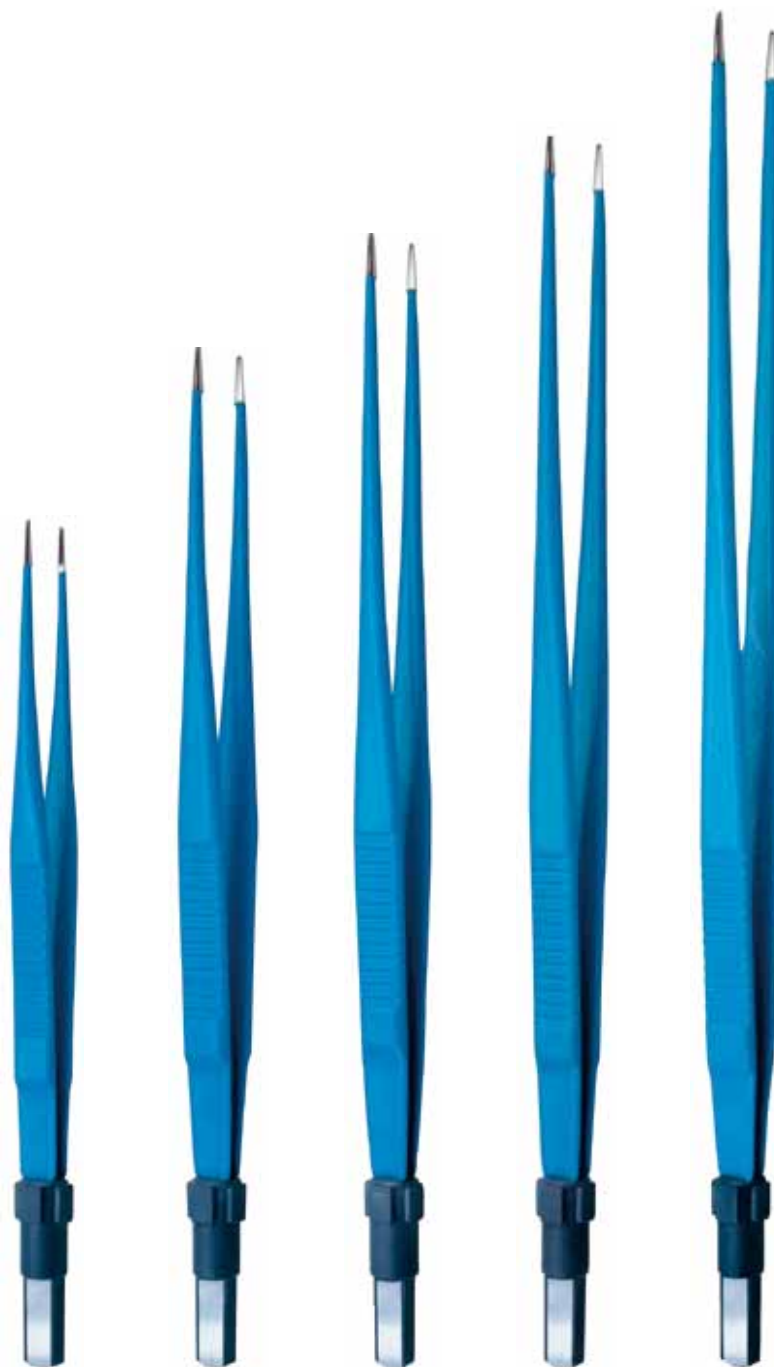

Connecteur Plug Enchufe	Largeur des pointes Width of tips Anchura de las puntas	150 mm	180 mm	200 mm	220 mm	240 mm
	0,3 mm	HF1515200	HF1518200	HF1520200	HF1522200	HF1524200
		HF1615200	HF1618200	HF1620200	HF1622200	HF1624200
	0,6 mm	HF1515204	HF1518204	HF1520204	-	-
	1,0 mm	HF1515201	HF1518201	HF1520201	HF1522201	HF1524201
		HF1615201	HF1618201	HF1620201	HF1622201	HF1624201
	2,0 mm	HF1515202	HF1518202	HF1520202	HF1522202	HF1524202
		HF1615202	HF1618202	HF1620202	HF1622202	HF1624202

500 Vp max

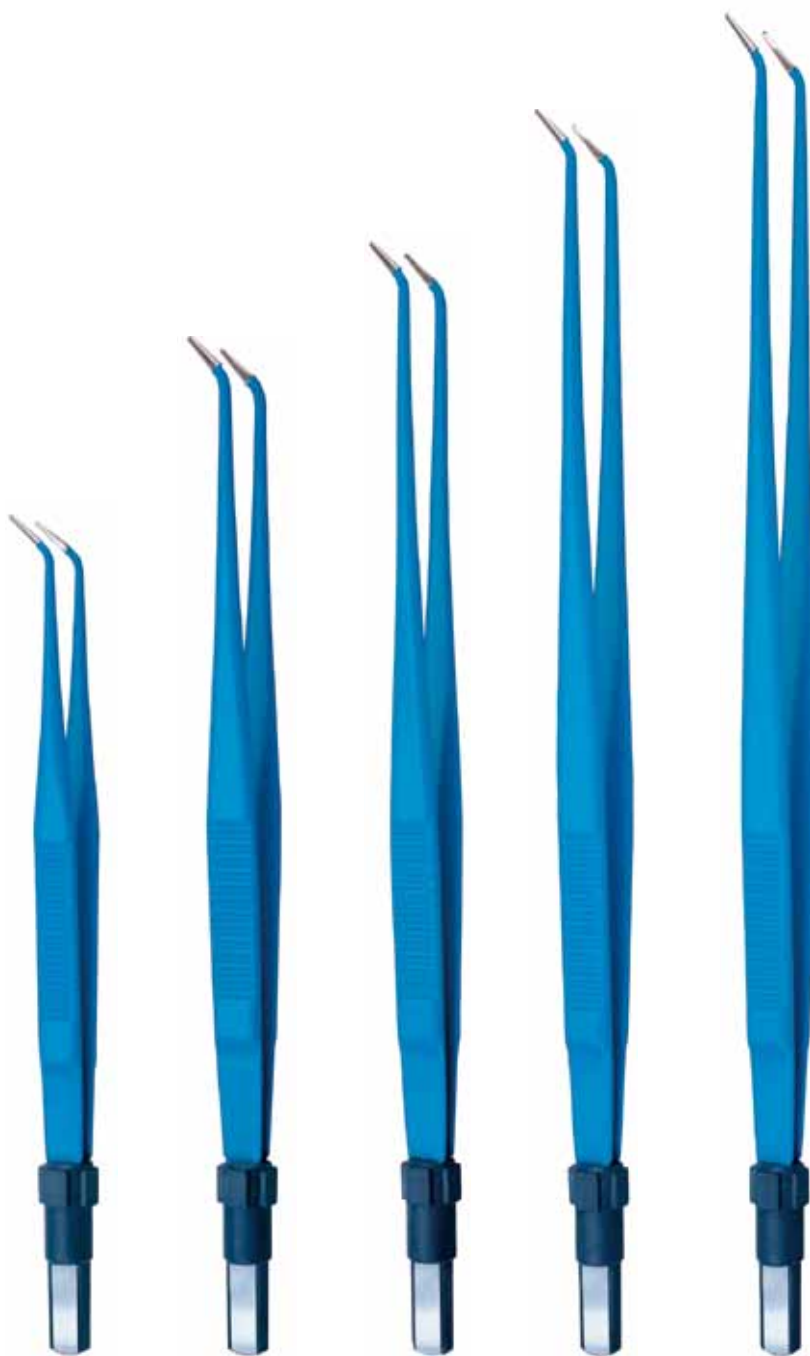

Connecteur  
Plug  
Enchufe

Largeur des pointes  
Width of tips  
Anchura de las puntas

150 mm

180 mm

200 mm

220 mm

240 mm

	0,3 mm	HF1515210	HF1518210	HF1520210	HF1522210	HF1524210
		HF1615210	HF1618210	HF1620210	HF1622210	HF1624210
	1,0 mm	HF1515211	HF1518211	HF1520211	HF1522211	HF1524211
		HF1615211	HF1618211	HF1620211	HF1622211	HF1624211
	2,0 mm	HF1515212	HF1518212	HF1520212	HF1522212	HF1524212
		HF1615212	HF1618212	HF1620212	HF1622212	HF1624212

500 Vp max



Connecteur  
Plug  
Enchufe

Largueur des pointes  
Width of tips  
Anchura de las puntas

180 mm

200 mm

220 mm

240 mm

	0,3 mm	HF1518300 HF1618300	HF1520300 HF1620300	HF1522300 HF1622300	HF1524300 HF1624300
	1,0 mm	HF1518301 HF1618301	HF1520301 HF1620301	HF1522301 HF1622301	HF1524301 HF1624301
	2,0 mm	HF1518302 HF1618302	HF1520302 HF1620302	HF1522302 HF1622302	HF1524302 HF1624302

500 Vp max



- Coudée en bas  
 Angled down tip  
 Acodada hacia abajo
- Coudée en haut  
 Angled up tip  
 Acodada hacia arriba



Connecteur Plug Enchufe	Largueur des pointes Width of tips Anchura de las puntas	180 mm	200 mm	220 mm	240 mm
	0,3 mm	HF1518340 HF1518330 HF1520340 HF1520330 HF1522340 HF1522330 HF1524340 HF1524330	HF1618340 HF1618330 HF1620340 HF1620330 HF1622340 HF1622330 HF1624340 HF1624330		
		HF1518341 HF1518331 HF1520341 HF1520331 HF1522341 HF1522331 HF1524341 HF1524331	HF1618341 HF1618331 HF1620341 HF1620331 HF1622341 HF1622331 HF1624341 HF1624331		
	1,0 mm	HF1518342 HF1518332 HF1520342 HF1520332 HF1522342 HF1522332 HF1524342 HF1524332	HF1618342 HF1618332 HF1620342 HF1620332 HF1622342 HF1622332 HF1624342 HF1624332		
		HF1518342 HF1518332 HF1520342 HF1520332 HF1522342 HF1522332 HF1524342 HF1524332	HF1618342 HF1618332 HF1620342 HF1620332 HF1622342 HF1622332 HF1624342 HF1624332		

500 Vp max

ADSON



Courbe  
Curved  
Curva



Droite  
Straight  
Recta



Connecteur  
Plug  
Enchufe

Largeur des pointes  
Width of tips  
Anchura de las puntas

170 mm

120 mm

	0,3 mm	HF1517400 HF1617400	- -
	1,0 mm	HF1517401 HF1617401	HF1512601 HF1612601
	2,0 mm	HF1517402 HF1617402	- -

300 Vp max

McPHERSON



Bijoutier  
Jeweler  
Relojero





Droite  
Straight  
Recta

Coudée  
Angled  
Acodada

Droite  
Straight  
Recta

Coudée  
Angled  
Acodada

Connecteur Plug Enchufe	Largeur des pointes Width of tips Anchura de las puntas	85 mm	85 mm	110 mm	110 mm
	0,25 mm	HF1807000	HF1807010	HF1811100	HF1811110
	0,45 mm	HF1807001	HF1807011	-	-
	0,60 mm	-	-	HF1811101	HF1811111

500 Vp max



Droite  
Straight  
Recta



Baïonnette  
Bayonet  
Baioneta



Connecteur Plug Enchufe	Largeur des pointes Width of tips Anchura de las puntas	180 mm	200 mm		180 mm	200 mm	220 mm
	0,5 x 8 mm	HF1018204	HF1020204	0,5 x 5 mm	HF1018304	HF1020304	HF1022304
		HF1118204	HF1120204		HF1118304	HF1120304	HF1122304
	1,0 x 8 mm	HF1018201	HF1020201	1,0 x 5 mm	HF1018301	HF1020301	HF1022301
		HF1118201	HF1120201		HF1118301	HF1120301	HF1122301
	2,0 x 8 mm	HF1018202	HF1020202	1,5 x 5 mm	HF1018303	HF1020303	HF1022303
		HF1118202	HF1120202		HF1118303	HF1120303	HF1122303



300 Vp max



Non adhésives  
No sticking  
No adhesivas

Bijoutier  
Jeweler  
Relojero

Droite  
Straight  
Recta

Coudée  
Angled  
Acodada



Connecteur Plug Enchufe	Largeur des pointes Width of tips Anchura de las puntas	110 mm	110 mm
	0,25 mm	HF0511100	HF0511110
		HF0611100	HF0611110
	0,60 mm	HF0511101	HF0511111
		HF0611101	HF0611111
	1,00 mm	HF0511103	HF0511113
		HF0611103	HF0611113

500 Vp max



**Non adhésives**  
**No sticking**  
**No adhesivas**

Coudée  
 Angled  
 Acodada

Droite  
 Straight  
 Recta

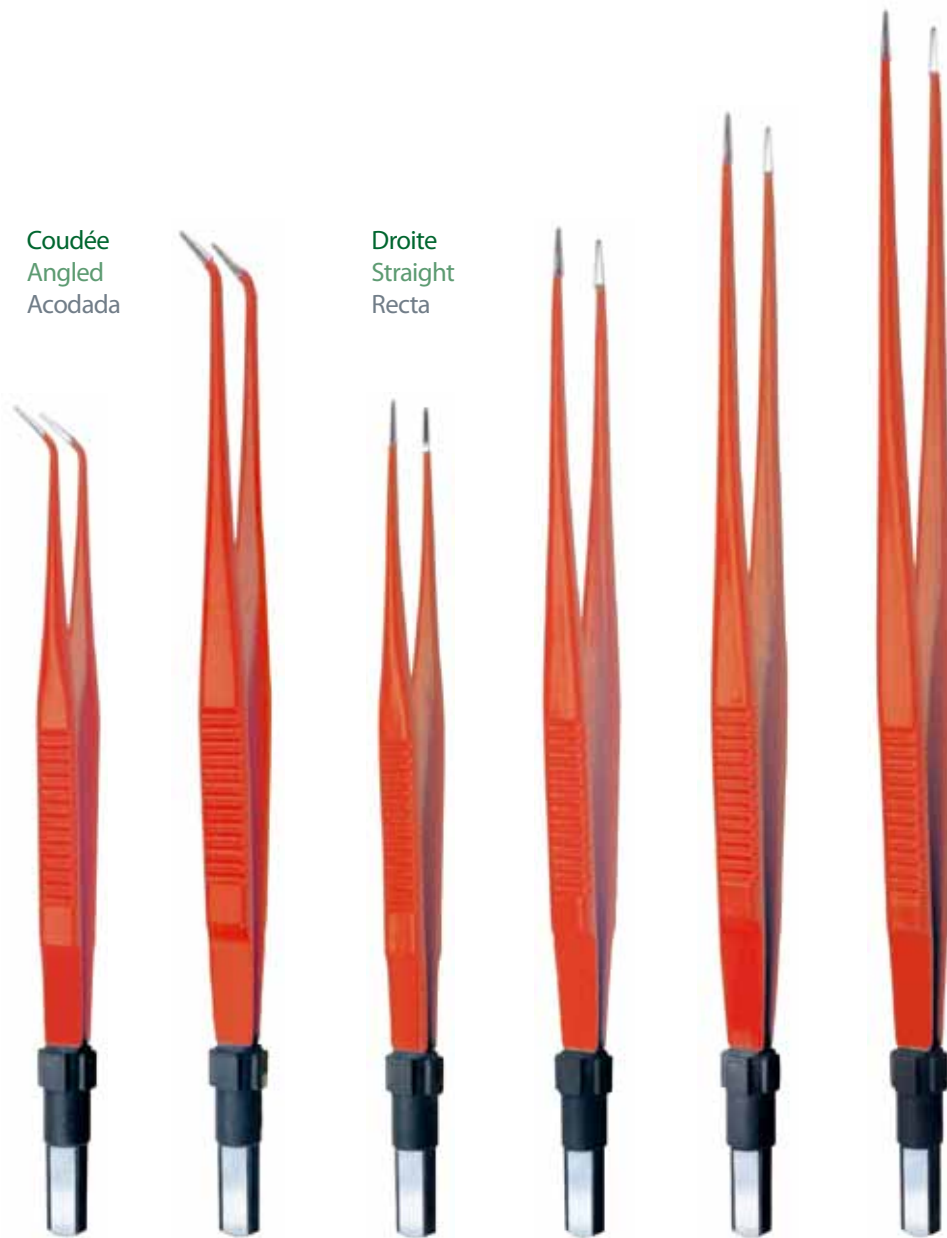

Connecteur Plug Enchufe	Largeur des pointes Width of tips Anchura de las puntas	150 mm	180 mm	150 mm	180 mm	200 mm	220 mm
	0,3 mm	HF0515210	HF0518210	HF0515200	HF0518200	HF0520200	HF0522200
		HF0615210	HF0618210	HF0615200	HF0618200	HF0620200	HF0622200
	0,6 mm	HF0515216	HF0518216	HF0515206	HF0518206	HF0520206	HF0522206
		HF0615216	HF0618216	HF0615206	HF0618206	HF0620206	HF0622206
	1,0 mm	HF0515211	HF0518211	HF0515201	HF0518201	HF0520201	HF0522201
		HF0615211	HF0618211	HF0615201	HF0618201	HF0620201	HF0622201
	2,0 mm	HF0515212	HF0518212	HF0515202	HF0518202	HF0520202	HF0522202
		HF0615212	HF0618212	HF0615202	HF0618202	HF0620202	HF0622202

500 Vp max



**Non adhésives**  
**No sticking**  
**No adhesivas**

Baïonnette  
 Bayonet  
 Bayoneta

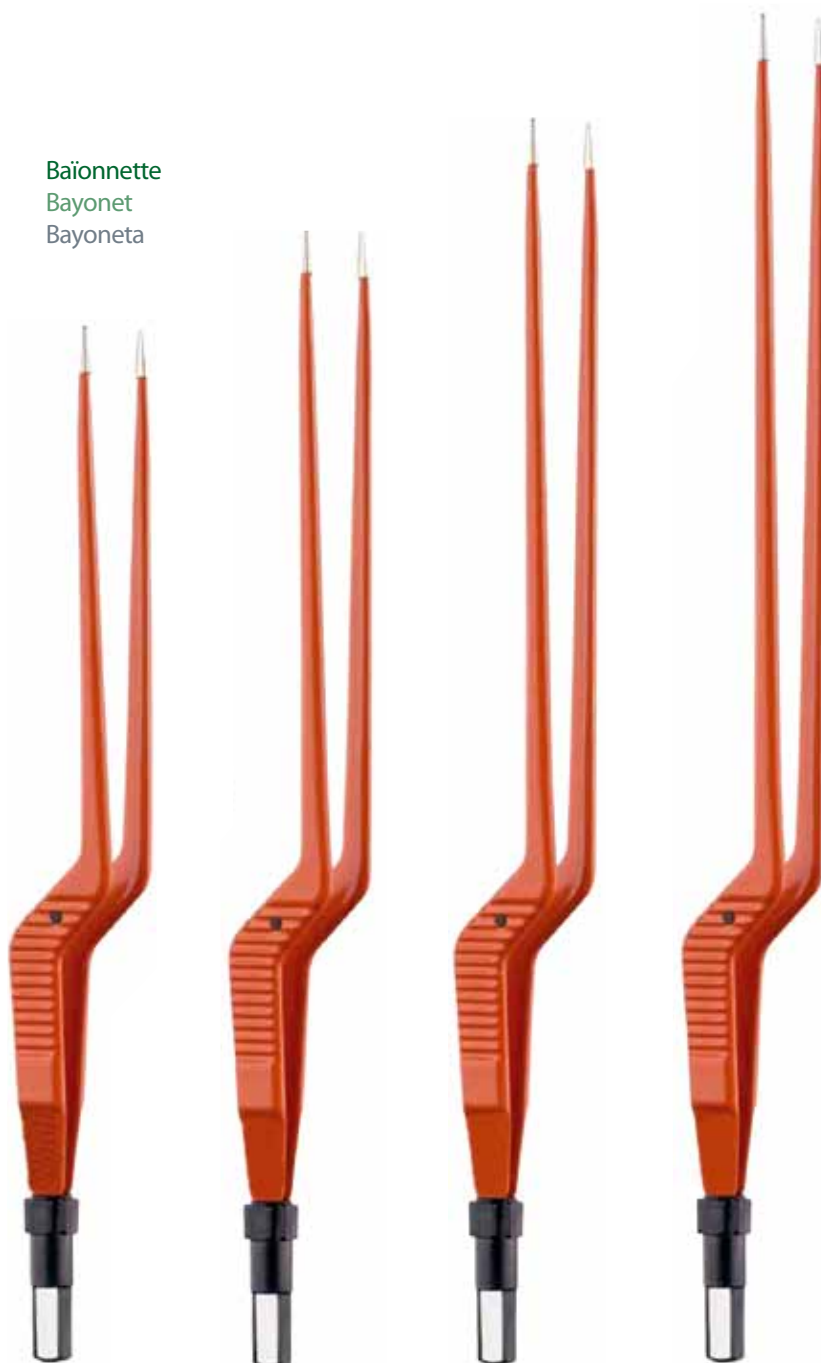

Connecteur  
 Plug  
 Enchufe

Largeur des pointes  
 Width of tips  
 Anchura de las puntas

180 mm

200 mm

220 mm

240 mm

	0,3 mm	HF0518300	HF0520300	HF0522300	HF0524300
		HF0618300	HF0620300	HF0622300	HF0624300
	0,6 mm	HF0518306	HF0520306	HF0522306	HF0524306
		HF0618306	HF0620306	HF0622306	HF0624306
	1,0 mm	HF0518301	HF0520301	HF0522301	HF0524301
		HF0618301	HF0620301	HF0622301	HF0624301
	2,0 mm	HF0518302	HF0520302	HF0522302	HF0524302
		HF0618302	HF0620302	HF0622302	HF0624302

500 Vp max

**Non adhésives**  
**No sticking**  
**No adhesivas**

↙ Coudée en bas  
 Angled down tip  
 Acodada hacia abajo

↗ Coudée en haut  
 Angled up tip  
 Acodada hacia arriba



Connecteur Plug Enchufe	Largeur des pointes Width of tips Anchura de las puntas	200 mm	220 mm
 1,0 mm		HF0520341	HF0520331
		HF0620341	HF0620331
		HF0522341	HF0522331
		HF0622341	HF0622331

300 Vp max



Lame standard  
Standard blade  
Hoja estándar



180 mm

HF5718110

210 mm

HF5721110

230 mm

HF5723110

280 mm

HF5728110

300 Vp max



Lame effilée  
Delicate blade  
Hoja delgada



180 mm  
HF5718120



210 mm  
HF5721120



230 mm  
HF5723120



280 mm  
HF5728120

250 Vp max



140 mm  
HF5791450

140 mm  
HF5791451

190 mm  
HF5791900

190 mm  
HF5791901

2 KVp max

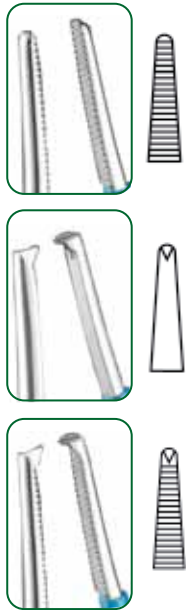

Connecteur Ø 4 mm  
 Plug Ø 4 mm  
 Enchufe Ø 4 mm

145 mm

180 mm

210 mm

250 mm

300 mm

210 mm



HF9714112

HF9618112

HF9621112

HF9625112

HF9630112

HF9621312



HF9714122

HF9618122

HF9621122

HF9625122

HF9630122

HF9621322



2 KVp max



ADSON

GILLIES

McINDOE

WAUGH

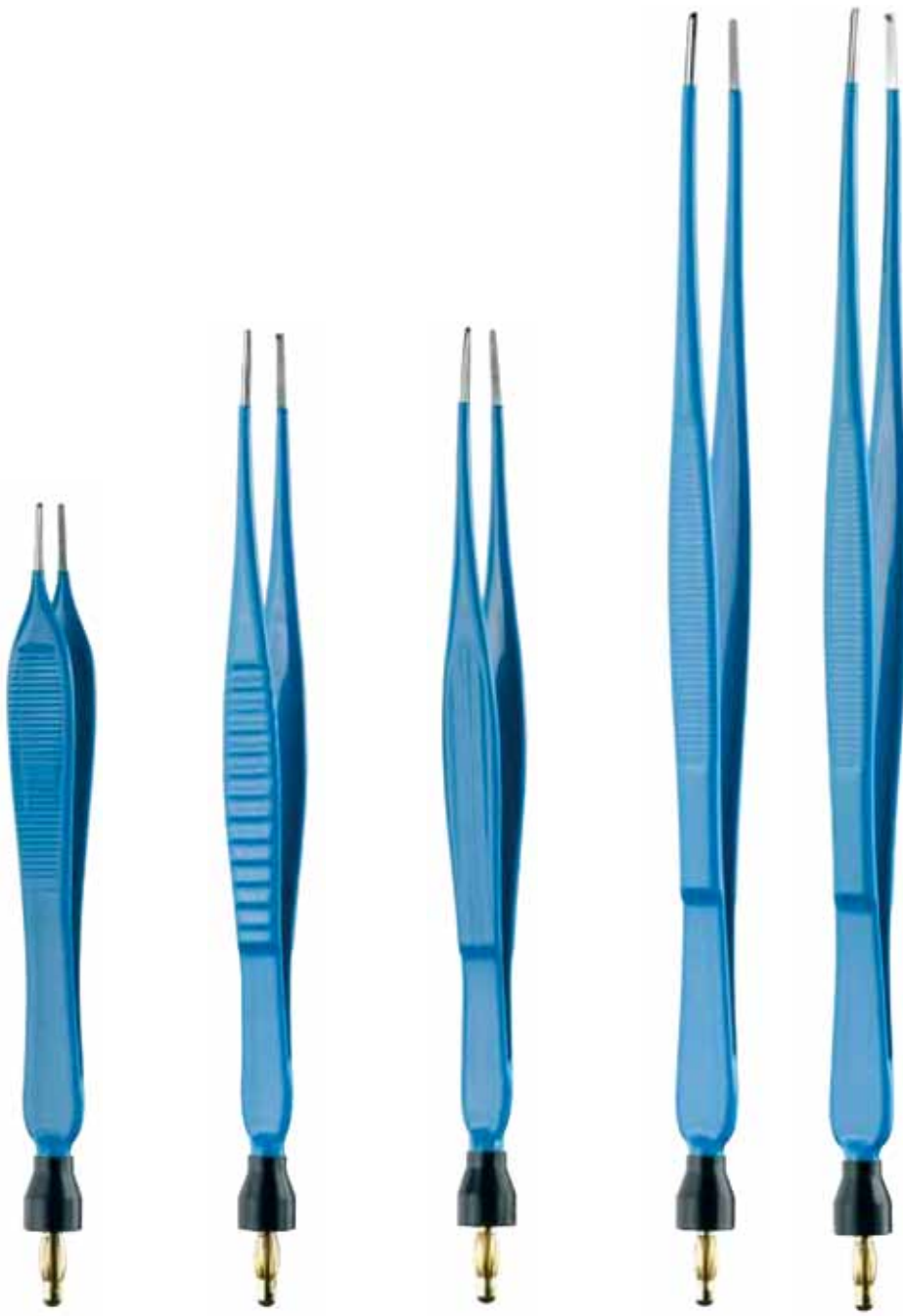

Connecteur Ø 4 mm  
 Plug Ø 4 mm  
 Enchufe Ø 4 mm

130 mm

150 mm

150 mm

205 mm

205 mm

	HF9690002	-	HF9690022	HF9690032	-
	-	HF9690012	-	-	-
	-	-	-	-	HF9690042

2 KVp max

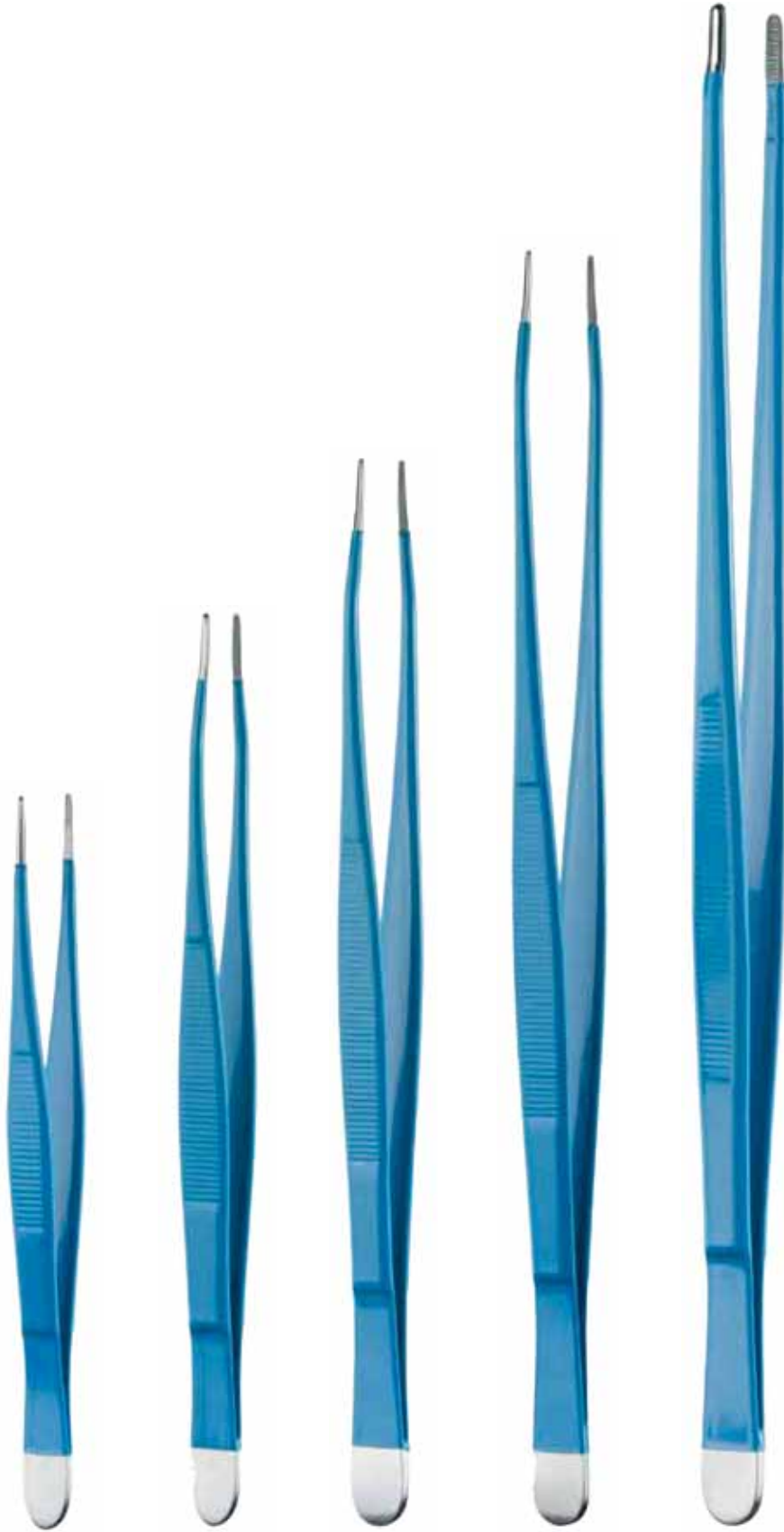

145 mm

180 mm

210 mm

250 mm

300 mm



HF9714110

HF9618110

HF9621110

HF9625110

HF9630110



HF9714120

HF9618120

HF9621120

HF9625120

HF9630120

2 KVp max



Connecteur Ø 4 mm  
 Plug Ø 4 mm  
 Enchufe Ø 4 mm

230 mm  
 HF9602184

200 mm  
 HF4620212

## Câbles bipolaires - Bipolar cables - Cables bipolares

Connecteur coté instrument  
Plug instrument side  
Enchufe lado del instrumento

Plat  
Flat  
Plano

Plat, coudé  
Flat, angled  
Plano, Acodada

Plat, carré  
Flat, square  
Plano, cuadrado

2 broches  
2 pins  
2 pines



Connecteur coté générateur  
Plug generator side  
Enchufe lado del generador

Erbe



3m	HF0100017	HF0100054	HF0100037	HF0100023
5m	HF0100018	HF0100056	HF0100038	HF0100029

Martin, Berchtold, Aesculap  
GK55, GK60



3m	HF0100019	HF0100058	HF0100039	HF0100043
5m	HF0100020	HF0100059	HF0100047	HF0100045

Valleylab, Lamidey,  
EMC



3m	HF0100021	HF0100046	HF0100034	HF0100053
5m	HF0100022	HF0100048	HF0100033	HF0100055

Erbe, EMC,  
Dolley



3m	-	HF0100003	-	-
5m	-	HF0100005	-	-

Aesculap GK4, GK20,  
GK21, GK30  
GK34, GK50,  
GK51



3m	HF0100035	-	-	HF0100073
5m	HF0100036	-	-	HF0100075

Valleylab autobipolar



3m	-	-	HF0100219	-
5m	-	-	-	-

## Câbles bipolaires - Bipolar cables - Cables bipolares

2 broches, coudée  
2 pins, angled  
2 pines, Acodada

Rond BiTech  
Round BiTech  
Redondo BiTech

Pince R. Wolf  
R.Wolf forceps  
Pinza R.Wolf

Pince Karl Storz  
Karl Storz forceps  
Pinza Karl Storz

Ciseaux Ethicon  
Ethicon scissors  
Tijeras Ethicon

Pince Aesculap  
Aesculap forceps  
Pinza Aesculap



-	HF0100082	HF0100092	HF0100095	HF0100198	HF0100150
-	HF0100086	HF0100192	HF0100195	HF0100298	-
-	HF0100083	HF0100093	HF0100096	HF0100199	HF0100130
-	HF0100087	HF0100193	HF0100196	HF0100299	-
HF0100153	HF0100084	HF0100089	HF0100097	HF0100197	-
HF0100155	HF0100088	HF0100189	-	HF0100297	-
-	-	-	-	-	-
-	-	-	-	-	-
-	-	-	-	-	HF0100140
-	-	-	-	-	-
-	-	-	-	-	-
-	-	-	-	-	-

## Câbles monopolaires - Monopolar cables - Cables monopolares

Connecteur coté instrument  
Plug instrument side  
Enchufe lado del instrumento

Ø 4 mm  
Douille  
Socket  
Zócalo

Ø 4 mm  
Douille coudée  
Socket angled  
Zócalo Acodada

Ø 2 mm  
Protégé pour résectoscope  
Plug protected for resectoscope  
Enchufe protegido para el  
resectoscopio



Connecteur coté générateur  
Plug generator side  
Enchufe lado del generador

Erbe T-Serie, Martin,  
Bertchold  
Ø 4 mm



3m	HF0100014	HF0100240	HF0100314
5m	HF0100016	HF0100241	-

Bovie, Valleylab,  
Conmed  
Ø 8 mm



3m	HF0100215	HF0100242	HF0100320
5m	HF0100221	-	-

Martin, Berchtold  
Ø 4 mm



3m	HF0100031	-	HF0100316
5m	HF0100331	-	-

Erbe ACC/ICC  
Ø 5 mm



3m	HF0100114	HF0100243	HF0100330
5m	HF0100115	-	HF0100360

## Câbles monopolaires - Monopolar cables - Cables monopolares

Ø 4 mm  
Protégé  
Plug protected  
Enchufe protegido

Ø 3 mm  
Douille  
Socket  
Zócalo

Ø 4 mm  
Douille hexagonale  
Hexagon socket  
Zócalo con hexágono



-

HF0100319

HF0100315

-

-

-

HF0100220

-

-

-

-

-

HF0100230

-

-

-

-

-

-

-

HF0100318

-

HF0100317

-



Pour enfants : surface de contact 128 cm<sup>2</sup> (8 x 16 cm)  
 For children : contact surface 128 cm<sup>2</sup> (8 x 16 cm)  
 Para niños : superficie de contacto 128 cm<sup>2</sup> (8 x 16 cm)

Avec connecteur Erbe, Integra, KLS Martin  
 with Erbe, Integra, KLS Martin plug  
 Con enchufe Erbe, Integra, KLS Martin

**HF9232004**

Avec connecteur KLS Martin  
 With KLS Martin plug  
 Con enchufe KLS Martin

**HF9232003**



Pour adultes : surface de contact 390 cm<sup>2</sup> (15 x 26 cm)  
 For adults : contact surface 390 cm<sup>2</sup> (15 x 26 cm)  
 Para adultos : superficie de contacto 390 cm<sup>2</sup> (15 x 26 cm)

Avec connecteur Erbe, Integra, KLS Martin  
 With Erbe, Integra, KLS Martin plug  
 Con enchufe Erbe, Integra, KLS Martin

**HF9242004**

Avec connecteur KLS Martin  
 With KLS Martin plug  
 Con enchufe KLS Martin





**HF9242003**



Connecteur pour électrodes neutres à usage unique  
 Plug for single-use electrodes  
 Enchufe para electrodos uso único



Connecteur côté générateur  
 Plug, generator side  
 Enchufe, lado del generator

<p>Erbe, Integra KLS Martin</p> 	<p>4,5 m      HF9101050</p>
<p>KLS Martin</p> 	<p>4,5 m      HF9101052</p>
<p>Valleylab, Conmed Erbe (international)</p> 	<p>4,5 m      HF9101051</p>
<p>Valleylab (Non REM), Conmed, Erbe (international)</p> 	<p>4,5 m      HF9101053</p>



### Indications importantes

Ce catalogue reste la propriété de LANDANGER. Nous pouvons demander le retour du catalogue dans le cas où celui-ci n'est pas utilisé conformément à nos intérêts, pour la vente ou l'achat de nos produits. Dans ce cas nous nous réservons le droit de mener des actions juridiques.

La reproduction ou la copie totale ou partielle de ce catalogue est interdite sans notre accord écrit.

Sous réserve des modifications techniques.

### Important notice

This catalogue remains property of LANDANGER. We can at any time recall the catalogue, in case that it has been not used according to our interests, i.e. sale or purchase of our products. We preserve the right for further steps in that case.

Reproduction or copying of this catalogue in whole or in parts is forbidden without our written permission.

Patterns are subject to change.

### Avisos importantes

Este catálogo queda la propiedad de LANDANGER. Podemos solicitar la devolución del catálogo en caso de que no sea utilizado para la compra o venta de nuestros productos. En este caso nos reservamos el derecho de tomar medidas judiciales.

La reproducción o copió total o parcial de este catálogo está prohibido sin nuestro consentimiento escrito.

Salvo modificaciones técnicas.

### Version 2011-00

Concept and design : LANDANGER - Photos non contractuelles

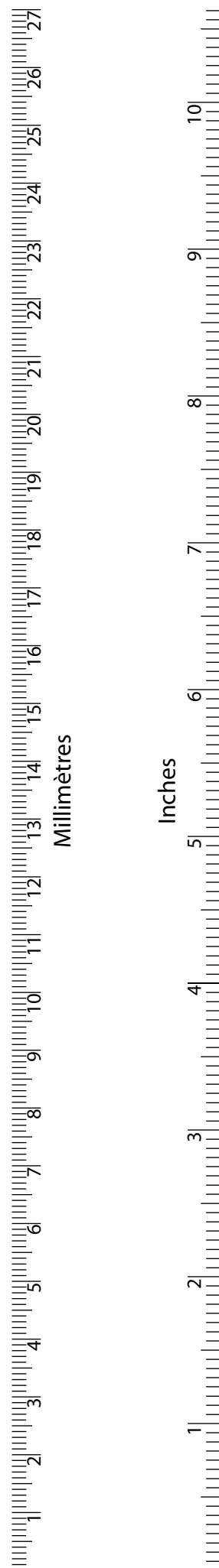

Siège - *Corporate Office*

13, Avenue de la République - 75011 Paris - France

Service Clients et Production - *Customer Service and Manufacturing*

Z.I. la Vendue - B.P. 2152 - 52906 Chaumont Cedex 9 - France

Tél.: +33 (0) 3 25 02 10 10 - Fax : +33 (0) 3 25 02 10 20 - Email : [contact@landanger.com](mailto:contact@landanger.com)

[www.landanger.com](http://www.landanger.com)

L A N D A N G E R





Delacroix-Chevalier  
*Paris*

Founded in 1920



For all information, quotes and orders :  
Pour tous renseignements, devis et commandes :



Tel. (Export) : +33 3 25 02 10 35  
Tél. (France) : 03 25 02 10 10  
Monday to Friday - Du lundi au vendredi  
From 8:00 am to 6:00 pm (non stop) - De 8 heures à 18 heures



Fax (Export) : +33 3 25 02 10 20  
Fax (France) : 03 25 02 10 20



Export : [export@delacroix-chevalier.com](mailto:export@delacroix-chevalier.com)  
France : [contact@delacroix-chevalier.com](mailto:contact@delacroix-chevalier.com)



**Delacroix-Chevalier**  
ZI la Vendue  
BP 2152 - 52906 Chaumont cedex 9  
FRANCE

[www.delacroix-chevalier.com](http://www.delacroix-chevalier.com)

ISO 13485

Contact :

---

---

---

---

---



# Delacroix-Chevalier

---

*Paris*

*Notre passion,  
notre histoire,  
créent  
la différence.*

Benoît Landanger

*Our passion, our history, make the difference.*



# Contents Sommaire

Pictograms / Pictogrammes .....	p. 3
Article Code Index / Index Alphanumérique .....	p. 5
Translation Table / Lexique Multilingue .....	p. 14
German / Allemand	
Dutch / Néerlandais	
Italian / Italien	
Spanish / Espagnol	
Alphabetical Index .....	p. 15
Index Alphabétique .....	p. 26
Heart Surgery Sets / Kits de Chirurgie Cardiaque .....	Chap. Kits
Dissection / Dissection .....	Chap. I
Scissors / Ciseaux .....	Chap. II
Retractors / Écarteurs .....	Chap. III
Clamps / Clamps .....	Chap. IV
Suture / Suture .....	Chap. V
Osseous / Osseux .....	Chap. VI
Special / Spéciaux .....	Chap. VII



## Pictograms / Pictogrammes

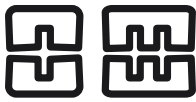

Cooley



DeBakey

Indicates instrument jaws pattern.  
*Indique le modèle des mors.*



Diamonite

Instrument jaws coated with tungsten carbide powder.  
*Mors micro diamantés.*



TC Inserts

Instrument jaws with Tungsten Carbide inserts.  
*Mors avec inserts Tungstène.*



Supercut

One blade is micro serrated, the other one is razor sharpened.  
*Une lame micro-dentée et une lame rasoir.*



Ultracut

Razor sharpened blades.  
*Lames rasoir*



Counterbalanced

Micro instrument heel is designed with a counterweight.  
*Contre-poids ajouté au talon de l'instrument.*



Titanium

Indicates instrument exists in Titanium version.  
*Indique que l'instrument existe en version Titane.*

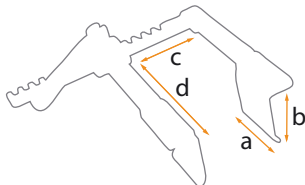

Indicates main dimensions of retractors.  
*Dimensions des écarteurs.*



Scale.  
*Echelle.*

**DC00000-00**

Indicates the article code.  
*Référence de l'instrument.*

**DC00000-00**

The orange code is for the largest instrument pictured.  
*Le cadre orange correspond à la photo présentée.*



## Article Code Index / Index Alphanumérique

Code	Ⓣ	Chap.	Page	Code	Ⓣ	Chap.	Page	Code	Ⓣ	Chap.	Page
B35007		II	36	B60620		IV	71	B86280		II	32
B35008		II	36	B60630		IV	71	B86285		II	32
B35042		II	37	B60650		IV	71	B86290		II	32
B35043		II	37	B60670		IV	71	B86295		II	32
B35044		II	37	B60710		IV	71	B86300		II	32
B35045		II	37	B60720		IV	71	B86305		II	33
B35046		II	37	B60730		IV	71	B86310		II	33
B35047		II	37	B60750		IV	71	B86315		II	33
B35048		II	39	B60753		IV	71	B86320		II	33
B35049		II	39	B60820		IV	72	B86325		II	34
B35050		II	39	B60885		IV	51	B86330		II	34
B35060		II	39	B60890		IV	51	B86335		II	34
B35070		II	39	B65190		IV	107	B86340		II	34
B35080		II	39	B65495		IV	108	B86345		II	34
B35090		II	39	B65500		IV	108	B86350		II	34
B35100		II	39	B802715		III	54	B86365		II	35
B351010		II	39	B802716		III	54	B86370		II	35
B351011		II	39	B802717		III	54	B86375		II	35
B351020		II	39	B802885		III	53	B86380		II	35
B351021		II	39	B802886		III	53	B86385		II	35
B35104		II	38	B802887		III	53	B86500		IV	104
B35106		II	38	B802888		III	53	B86505		IV	104
B35110		II	38	B802889		III	53	B86510		IV	104
B35120		II	38	B802890		III	53	B86515		IV	104
B35130		II	38	B802891		III	53	B86520		IV	103
B35140		II	38	B802892		III	53	B86525		IV	103
B35150		II	38	B802893		III	53	B86530		IV	103
B35160		II	38	B802894		III	53	B86535		IV	103
B35172		II	38	B802912		III	39	B86540		IV	103
B35174		II	38	B802913		III	39	B86545		IV	103
B351750		II	38	B802914		III	39	B86550		IV	103
B351751		II	38	B802915		III	39	B86555		IV	103
B351780		II	38	B80301		III	49	B86560		IV	105
B351781		II	38	B80302		III	49	B86570		IV	105
B35228		II	40	B80303		III	49	B86580		IV	101
B35230		II	40	B80304		III	49	B86590		IV	101
B35232		II	40	B80306		III	49	B86595		IV	101
B35234		II	40	B80330		VII	4	B86600		IV	102
B35240		II	38	B80382		III	47	B86610		IV	102
B35250		II	38	B80385		III	47	B86700		I	20
B35260		II	40	B803934		III	47	B86705		I	20
B40440		I	23	B80405		III	45	B86710		I	20
B40445		I	23	B80410		III	45	B86715		I	20
B404450		I	23	B80535		III	41	B86720		I	20
B404451		I	23	B80537		III	41	B86725		I	20
B404453		I	23	B80538		III	41	B86730		I	22
B404454		I	23	B80540		III	41	B86735		I	22
B40446		I	23	B80544		III	40	B86740		I	22
B40447		I	23	B80546		III	40	B86745		I	22
B404470		I	23	B80551		III	40	B86750		I	21
B404471		I	23	B86205		II	31	B86755		I	21
B40448		I	18	B86210		II	31	B86760		I	21
B60400		IV	106	B86215		II	31	B86765		I	21
B60420		IV	106	B86220		II	31	B86770		I	21
B60535		IV	72	B86225		II	31	B86775		I	21
B60540		IV	71	B86230		II	31	B86780		I	21
B60550		IV	71	B86235		II	31	B86785		I	21
B60560		IV	71	B86240		II	31	B95150		VII	18
B60580		IV	71	B86245		II	31	B95200		VII	18
B60601		IV	71	B86250		II	31	B952014		VII	18
B60603		IV	71	B86255		II	31	B952018		VII	18
B60604		IV	71	B86260		II	31	B952020		VII	18
B60606		IV	71	B86265		II	32	B95205		VII	18
B60608		IV	71	B86270		II	32	B95210		VII	18
B60610		IV	71	B86275		II	32	C10855		IV	55

## Article Code Index / Index Alphanumérique

Code	Ⓣ	Chap.	Page	Code	Ⓣ	Chap.	Page	Code	Ⓣ	Chap.	Page
C10860		IV	55	DC12600-15		I	8	DC14001-18		I	14
C10865		IV	54	DC12600-18		I	8	DC14100-14		I	14
C10870		IV	54	DC12600-21		I	8	DC14100-18		I	14
C10875		IV	54	DC12601-15		I	8	DC14110-14		I	14
C10880		IV	54	DC12601-18		I	8	DC14110-18		I	14
C10890		IV	54	DC12601-21		I	8	DC14210-14		I	14
C10895		IV	54	DC12710-15		I	8	DC14210-18		I	14
C10900		IV	53	DC12710-18		I	8	DC14211-14		I	14
C10905		IV	53	DC12710-21		I	8	DC14211-18		I	14
C10910		IV	52	DC12810-15		I	8	DC14300-12		I	15
C10915		IV	52	DC12810-18		I	8	DC14300-16		I	15
C10920		IV	52	DC12810-21		I	8	DC14300-20		I	15
C10925		IV	52	DC12900-12		I	9	DC14300-24		I	15
C10930		IV	52	DC12900-15	+TI	I	9	DC14310-12		I	15
C10935		IV	52	DC12900-18	+TI	I	9	DC14310-16		I	15
DC12000-12		I	3	DC12900-21	+TI	I	9	DC14310-20		I	15
DC12000-15	+TI	I	3	DC12905-12		I	9	DC14310-24		I	15
DC12000-18	+TI	I	3	DC12905-15	+TI	I	9	DC14800-15		I	16
DC12000-21	+TI	I	3	DC12905-18	+TI	I	9	DC14900-18	+TI	I	16
DC12000-23	+TI	I	3	DC12905-21	+TI	I	9	DC15100-12		I	17
DC12001-12		I	3	DC12920-15		I	9	DC15100-14		I	17
DC12001-15	+TI	I	3	DC12920-18		I	9	DC15100-16		I	17
DC12001-18	+TI	I	3	DC12920-21		I	9	DC15100-18		I	17
DC12001-21	+TI	I	3	DC12925-15		I	9	DC15100-21		I	17
DC12001-23	+TI	I	3	DC12925-18		I	9	DC15100-23		I	17
DC12010-18	+TI	I	3	DC12925-21		I	9	DC15100-25		I	17
DC12010-21	+TI	I	3	DC12940-18	+TI	I	9	DC15200-15		I	18
DC12100-12		I	5	DC12940-21	+TI	I	9	DC15200-23		I	18
DC12100-15	+TI	I	5	DC13010-18		I	10	DC15200-25		I	18
DC12100-18	+TI	I	5	DC13010-23	+TI	I	10	DC15400-15		I	19
DC12100-21	+TI	I	5	DC13010-27		I	10	DC15400-20		I	19
DC12101-12		I	5	DC13010-32		I	10	DC15400-24		I	19
DC12101-15	+TI	I	5	DC13020-18		I	10	DC15500-15		I	19
DC12101-18	+TI	I	5	DC13020-23	+TI	I	10	DC15500-20		I	19
DC12101-21	+TI	I	5	DC13020-27		I	10	DC15500-24		I	19
DC12310-12		I	6	DC13020-32		I	10	DC15600-15		I	19
DC12310-15	+TI	I	6	DC13100-16	+TI	I	12	DC15600-20		I	19
DC12310-18	+TI	I	6	DC13100-20	+TI	I	12	DC15600-24		I	19
DC12310-21	+TI	I	6	DC13100-24	+TI	I	12	DC15700-15		I	19
DC12311-12		I	6	DC13100-30		I	12	DC15700-20		I	19
DC12311-15	+TI	I	6	DC13101-12		I	12	DC15700-24		I	19
DC12311-18	+TI	I	6	DC13101-16		I	12	DC16600-11		I	24
DC12311-21	+TI	I	6	DC13101-20	+TI	I	12	DC16601-11		I	24
DC12320-15		I	6	DC13101-24		I	12	DC16700-11		I	24
DC12320-18		I	6	DC13101-30		I	12	DC16800-13		I	24
DC12320-21		I	6	DC13110-28	+TI	I	11	DC16900-13		I	24
DC12321-15		I	6	DC13200-16	+TI	I	12	DC17000-11		I	24
DC12321-18		I	6	DC13200-20	+TI	I	12	DC17001-11		I	24
DC12321-21		I	6	DC13200-24	+TI	I	12	DC17100-11		I	24
DC12330-18	+TI	I	6	DC13200-30		I	12	DC17200-13		I	24
DC12330-21	+TI	I	6	DC13300-16	+TI	I	12	DC17300-13		I	24
DC12340-18	+TI	I	6	DC13300-20	+TI	I	12	DC20000-18	II	6	
DC12340-21	+TI	I	6	DC13300-24	+TI	I	12	DC20001-18	II	6	
DC12410-12		I	7	DC13300-30		I	12	DC20010-18	II	5	
DC12410-15	+TI	I	7	DC13400-16		I	12	DC20011-18	+TI	II	5
DC12410-18	+TI	I	7	DC13400-20		I	12	DC20032-18	II	15	
DC12410-21	+TI	I	7	DC13400-24		I	12	DC20033-18	II	15	
DC12411-12		I	7	DC13400-30		I	12	DC20040-18	II	15	
DC12411-15	+TI	I	7	DC13500-16	+TI	I	13	DC20050-12	II	8	
DC12411-18	+TI	I	7	DC13500-20	+TI	I	13	DC20050-18	II	8	
DC12411-21	+TI	I	7	DC13500-24	+TI	I	13	DC20051-12	II	8	
DC12500-18		I	4	DC13500-30		I	13	DC20051-18	II	8	
DC12500-21		I	4	DC14000-14		I	14	DC20052-12	II	8	
DC12501-18		I	4	DC14000-18		I	14	DC20052-18	II	8	
DC12501-21		I	4	DC14001-14		I	14	DC20053-12	II	8	

## Article Code Index / Index Alphanumérique

Code	Ⓣ	Chap.	Page	Code	Ⓣ	Chap.	Page	Code	Ⓣ	Chap.	Page
DC20053-18		II	8	DC20142-18		II	11	DC21173-18		II	21
DC20054-12		II	8	DC20143-18		II	11	DC21174-14		II	21
DC20054-18		II	8	DC20144-18		II	11	DC21174-18		II	21
DC20055-12		II	7	DC20145-18		II	11	DC21180-14		II	25
DC20055-18		II	7	DC20146-18		II	11	DC21180-18		II	25
DC20056-12		II	7	DC20150-18		II	4	DC21181-14		II	25
DC20056-18		II	7	DC20151-18		II	4	DC21181-18		II	25
DC20057-12		II	7	DC20152-18		II	10	DC21211-15		II	19
DC20057-18		II	7	DC20153-18		II	10	DC21211-19		II	19
DC20058-12		II	7	DC20154-18		II	10	DC21212-15		II	19
DC20058-18		II	7	DC20155-18		II	10	DC21212-19		II	19
DC20059-12		II	7	DC20156-18		II	10	DC21213-15		II	19
DC20059-18		II	7	DC20160-12		II	12	DC21213-19		II	19
DC20060-12		II	9	DC20160-18		II	12	DC21214-15		II	19
DC20060-18		II	9	DC20161-12		II	12	DC21214-19		II	19
DC20060-21		II	9	DC20161-18		II	12	DC21215-15		II	19
DC20061-12		II	9	DC20162-12		II	12	DC21215-19		II	19
DC20061-18	+TI	II	9	DC20162-18		II	12	DC21220-14		II	25
DC20061-21		II	9	DC20163-12		II	12	DC21220-17		II	25
DC20062-12		II	9	DC20163-18		II	12	DC21220-18		II	26
DC20062-18	+TI	II	9	DC20164-12		II	12	DC21221-13		II	20
DC20062-21		II	9	DC20164-18		II	12	DC21221-18		II	20
DC20063-12		II	9	DC21000-24	+TI	II	29	DC21222-13		II	20
DC20063-18	+TI	II	9	DC21000-27	+TI	II	29	DC21222-18		II	20
DC20063-21		II	9	DC21001-24	+TI	II	29	DC21223-13		II	20
DC20064-12		II	9	DC21001-27	+TI	II	29	DC21223-18		II	20
DC20064-18	+TI	II	9	DC21050-18		II	28	DC21224-13		II	20
DC20064-21		II	9	DC21050-26		II	28	DC21224-18		II	20
DC20065-12		II	7	DC21100-14		II	17	DC21225-13		II	20
DC20065-18		II	7	DC21100-17		II	17	DC21225-18		II	20
DC20100-19		II	16	DC21101-14		II	17	DC21230-14		II	24
DC20100-22		II	16	DC21101-17		II	17	DC21230-17		II	24
DC20100-24		II	16	DC21102-14		II	17	DC21231-14		II	24
DC20101-19		II	16	DC21102-17		II	17	DC21231-17		II	24
DC20101-22	+TI	II	16	DC21103-14		II	17	DC21232-14		II	24
DC20101-24		II	16	DC21103-17		II	17	DC21232-17		II	24
DC20102-19		II	16	DC21103-22		II	17	DC21233-17		II	24
DC20102-22	+TI	II	16	DC21104-14		II	17	DC21234-14		II	24
DC20102-24		II	16	DC21104-17		II	17	DC21234-17		II	24
DC20103-19		II	16	DC21104-22		II	17	DC21235-14		II	24
DC20103-22	+TI	II	16	DC21105-14		II	17	DC21235-17		II	24
DC20103-24		II	16	DC21105-17		II	17	DC21260-00		II	22
DC20110-12		II	3	DC21105-22		II	17	DC21261-00		II	22
DC20110-18		II	3	DC21106-28		II	17	DC21270-00		II	23
DC20111-12		II	3	DC21107-28		II	17	DC21270-14		II	23
DC20111-18		II	3	DC21108-28		II	17	DC21272-14		II	23
DC20112-09		II	3	DC21112-17		II	27	DC21272-17		II	23
DC20112-12		II	3	DC21130-14		II	27	DC21273-14		II	23
DC20112-18		II	3	DC21130-18		II	27	DC21273-17		II	23
DC20113-09		II	3	DC21131-14		II	27	DC21274-00		II	23
DC20113-12		II	3	DC21131-18		II	27	DC21274-14		II	23
DC20113-18		II	3	DC21132-18		II	27	DC21275-00		II	23
DC20114-18		II	5	DC21150-15		II	18	DC21275-14		II	23
DC20120-18		II	14	DC21150-19		II	18	DC21276-14		II	23
DC20121-18		II	14	DC21151-15		II	18	DC21276-17		II	23
DC20122-18		II	14	DC21151-19		II	18	DC21290-00		II	26
DC20123-18		II	14	DC21152-15		II	18	DC21300-17		II	22
DC20124-18		II	14	DC21152-19		II	18	DC21320-18		II	22
DC20130-18		II	13	DC21170-14		II	21	DC21400-18		II	30
DC20131-18		II	13	DC21170-18		II	21	DC21400-20		II	30
DC20132-18		II	13	DC21171-14		II	21	DC21400-23		II	30
DC20133-18		II	13	DC21171-18		II	21	DC21410-18		II	30
DC20134-18		II	13	DC21172-14		II	21	DC21410-20		II	30
DC20140-18		II	4	DC21172-18		II	21	DC21410-23		II	30
DC20141-18		II	4	DC21173-14		II	21	DC30000-00	III	3	

## Article Code Index / Index Alphanumérique

Code	Ⓣ	Chap.	Page	Code	Ⓣ	Chap.	Page	Code	Ⓣ	Chap.	Page
DC30001-00		III	3	DC31000-90		III	22	DC33400-00		III	32
DC30002-00		III	4	DC31010-30		III	23	DC33410-25		III	52
DC30010-00		III	5	DC31011-40		III	23	DC33411-35		III	52
DC30020-00		III	5	DC31020-30		III	23	DC33600-25		III	45
DC30030-00		III	5	DC31021-40		III	23	DC33600-50		III	45
DC30040-15		III	5	DC31030-00		III	23	DC33600-60		III	45
DC30050-25		III	5	DC31100-20		III	21	DC33700-09		III	48
DC30100-00		III	6	DC31100-75		III	21	DC33700-11		III	48
DC30200-00		III	8	DC31200-01		III	21	DC33700-13		III	48
DC30210-20		III	9	DC31200-02		III	21	DC33700-15		III	48
DC30211-25		III	9	DC31200-03		III	21	DC33700-18		III	48
DC30212-20		III	9	DC31200-04		III	21	DC33800-09		III	48
DC30219-23		III	9	DC31300-01		III	24	DC33800-11		III	48
DC30220-28		III	9	DC31300-02		III	24	DC33800-13		III	48
DC30221-32		III	9	DC31300-03		III	24	DC33800-15		III	48
DC30222-38		III	9	DC31300-04		III	25	DC33800-18		III	48
DC30223-43		III	9	DC31300-05		III	25	DC34000-14		III	49
DC30224-50		III	9	DC31300-06		III	25	DC34000-18		III	49
DC30229-23		III	9	DC31500-00		III	29	DC34000-22		III	49
DC30230-28		III	9	DC31502-00		III	29	DC34100-00		III	50
DC30231-32		III	9	DC31510-40		III	29	DC34200-01		III	50
DC30232-38		III	9	DC31511-72		III	29	DC34200-02		III	50
DC30233-43		III	9	DC31600-08		III	30	DC34400-01		III	50
DC30234-50		III	9	DC31602-12		III	30	DC34400-02		III	50
DC30250-00		III	9	DC31610-45		III	30	DC34550-24		III	50
DC30300-00		III	7	DC31611-65		III	30	DC35400-25		III	55
DC30400-00		III	12	DC31650-00		III	26	DC35400-30		III	55
DC30412-32		III	13	DC31651-00		III	26	DC35600-25		III	56
DC30420-30		III	13	DC31652-00		III	26	DC35600-38		III	56
DC30421-40		III	13	DC31653-00		III	26	DC35600-50		III	56
DC30422-50		III	13	DC31654-00		III	27	DC35600-75		III	56
DC30424-40		III	13	DC31655-00		III	27	DC35800-40		III	46
DC30430-00		III	13	DC31656-00		III	27	DC35800-62		III	46
DC30500-00		III	14	DC31657-00		III	28	DC35801-40		III	46
DC30510-22		III	15	DC31658-00		III	28	DC35801-62		III	46
DC30511-30		III	15	DC31659-00		III	28	DC36100-50		III	38
DC30512-35		III	15	DC31700-00		III	31	DC36100-90		III	38
DC30513-50		III	15	DC31900-00		III	32	DC36200-30		III	46
DC30600-00		III	16	DC32000-00		III	33	DC36300-14		III	57
DC30700-00		III	10	DC32001-00		III	33	DC36300-16		III	57
DC30709-23		III	11	DC32200-00		III	35	DC36300-18		III	57
DC30710-28		III	11	DC32300-00		III	34	DC36400-24		III	43
DC30711-32		III	11	DC32450-25		III	36	DC36800-03		III	37
DC30712-38		III	11	DC32450-28		III	36	DC36800-06		III	37
DC30713-50		III	11	DC32450-38		III	36	DC36800-09		III	37
DC30714-00		III	11	DC32450-54		III	36	DC36800-12		III	37
DC30714-43		III	11	DC32800-08		III	17	DC38000-27		III	51
DC30720-10		III	11	DC32800-09		III	17	DC38001-27		III	51
DC30721-20		III	11	DC32810-00		III	17	DC40000-14		IV	74
DC30722-25		III	11	DC32811-00		III	17	DC40001-13		IV	74
DC30730-30		III	11	DC32812-08		III	17	DC40002-11		IV	74
DC30731-30		III	11	DC32812-09		III	17	DC40003-13		IV	74
DC30732-40		III	11	DC33000-14		III	42	DC40004-13		IV	74
DC30733-50		III	11	DC33000-17		III	42	DC40010-16	+TI	IV	38
DC30740-00		III	11	DC33000-20		III	42	DC40020-15		IV	38
DC30800-00		III	18	DC33100-00		III	43	DC40021-16		IV	38
DC30810-25		III	19	DC33100-28		III	43	DC40030-17		IV	65
DC30811-35		III	19	DC33100-90		III	43	DC40031-17		IV	65
DC30812-45		III	19	DC33110-00		III	43	DC40040-19		IV	33
DC30813-55		III	19	DC33110-01		III	43	DC40041-22		IV	33
DC30900-20		III	20	DC33120-00		III	43	DC40042-19		IV	33
DC30900-35		III	20	DC33200-15		III	44	DC40043-22		IV	33
DC30900-45		III	20	DC33200-20		III	44	DC40044-18		IV	33
DC30900-55		III	20	DC33300-03		III	44	DC40045-26		IV	33
DC30991-40		III	13	DC33300-04		III	44	DC40050-20	+TI	IV	61



## Article Code Index / Index Alphanumérique

Code	Ⓣ	Chap.	Page	Code	Ⓣ	Chap.	Page	Code	Ⓣ	Chap.	Page
DC40051-21		IV	61	DC40281-31		IV	7	DC40612-21		IV	40
DC40052-25	+TI	IV	61	DC40290-20		IV	89	DC40613-24		IV	40
DC40053-26		IV	61	DC40290-23		IV	89	DC40614-18		IV	41
DC40054-25		IV	61	DC40290-26		IV	89	DC40615-16		IV	41
DC40055-23		IV	61	DC40290-31		IV	89	DC40616-17		IV	41
DC40056-30	+TI	IV	61	DC40291-20		IV	89	DC40617-19		IV	41
DC40057-27		IV	61	DC40291-23		IV	89	DC40618-20		IV	64
DC40059-24		IV	61	DC40291-26		IV	89	DC40620-16	+TI	IV	92
DC40060-20		IV	32	DC40291-31		IV	89	DC40621-17	+TI	IV	92
DC40070-19		IV	66	DC40300-31		IV	22	DC40622-16		IV	92
DC40071-23	+TI	IV	66	DC40320-17		IV	44	DC40623-17	+TI	IV	92
DC40080-26		IV	15	DC40321-18		IV	44	DC40624-21		IV	92
DC40081-24		IV	8	DC40322-18		IV	44	DC40625-22		IV	92
DC40082-27		IV	8	DC40323-18		IV	44	DC40626-26		IV	92
DC40083-31	+TI	IV	8	DC40330-22		IV	18	DC40627-17		IV	91
DC40084-32		IV	8	DC40340-22	+TI	IV	90	DC40628-17	+TI	IV	16
DC40090-20	+TI	IV	39	DC40341-23	+TI	IV	90	DC40629-17		IV	91
DC40091-18	+TI	IV	39	DC40342-26		IV	90	DC40630-16		IV	91
DC40100-12		IV	73	DC40343-20	+TI	IV	90	DC40631-17		IV	91
DC40101-12		IV	73	DC40344-23	+TI	IV	90	DC40632-20		IV	91
DC40110-14		IV	73	DC40345-26		IV	90	DC40633-22		IV	91
DC40111-14		IV	73	DC40346-21		IV	37	DC40634-25		IV	91
DC40120-16		IV	73	DC40347-22		IV	37	DC40640-22	+TI	IV	30
DC40121-16		IV	73	DC40351-22		IV	42	DC40641-26	+TI	IV	30
DC40130-14		IV	35	DC40352-22		IV	42	DC40642-24		IV	30
DC40132-18		IV	35	DC40361-18		IV	42	DC40643-27		IV	30
DC40133-20		IV	35	DC40362-26	+TI	IV	42	DC40650-28		IV	31
DC40135-28		IV	35	DC40363-18		IV	42	DC40651-25		IV	31
DC40140-14		IV	35	DC40370-12		IV	49	DC40652-31		IV	10
DC40142-18		IV	35	DC40371-16		IV	49	DC40653-18		IV	9
DC40143-20		IV	35	DC40372-15		IV	49	DC40654-27		IV	9
DC40145-28		IV	35	DC40373-14		IV	49	DC40655-33		IV	9
DC40200-17		IV	60	DC40380-26	+TI	IV	58	DC40660-22		IV	17
DC40203-15		IV	60	DC40381-28		IV	58	DC40661-27		IV	17
DC40204-17		IV	60	DC40400-20		IV	29	DC40662-26	+TI	IV	17
DC40210-24		IV	11	DC40410-20		IV	14	DC40663-20		IV	17
DC40210-25		IV	11	DC40411-20	+TI	IV	14	DC40664-25		IV	17
DC40210-27		IV	11	DC40420-23		IV	50	DC40665-27		IV	17
DC40220-17		IV	34	DC40421-25		IV	50	DC40670-20		IV	26
DC40221-16		IV	34	DC40430-19		IV	36	DC40671-25		IV	26
DC40222-18		IV	34	DC40431-19		IV	36	DC40672-26		IV	26
DC40223-18		IV	34	DC40432-19		IV	36	DC40673-26		IV	26
DC40230-16	+TI	IV	16	DC40433-19		IV	36	DC40674-27		IV	26
DC40231-20		IV	16	DC40440-20		IV	24	DC40680-20		IV	63
DC40232-19		IV	16	DC40441-20		IV	24	DC40681-24		IV	63
DC40240-17		IV	45	DC40460-25		IV	13	DC40690-17		IV	69
DC40241-17		IV	45	DC40480-26		IV	19	DC40691-17		IV	69
DC40242-17		IV	45	DC40510-26		IV	12	DC40692-17		IV	69
DC40250-25		IV	6	DC40511-26		IV	12	DC40693-17		IV	69
DC40251-24		IV	6	DC40520-21		IV	43	DC40700-14		IV	62
DC40252-25		IV	6	DC40521-22		IV	43	DC40701-16		IV	62
DC40253-24		IV	6	DC40530-26		IV	21	DC40702-16		IV	62
DC40255-26	+TI	IV	23	DC40540-21		IV	20	DC40710-16	+TI	IV	47
DC40256-22		IV	23	DC40541-25		IV	20	DC40711-16	+TI	IV	47
DC40257-27		IV	23	DC40542-30		IV	20	DC40712-18	+TI	IV	47
DC40260-20		IV	25	DC40600-13		IV	75	DC40713-18	+TI	IV	47
DC40261-25		IV	25	DC40601-12		IV	75	DC40720-18	+TI	IV	32
DC40262-26		IV	25	DC40602-10	+TI	IV	75	DC40721-19	+TI	IV	32
DC40263-26		IV	25	DC40603-13	+TI	IV	75	DC40730-20		IV	27
DC40264-27		IV	25	DC40604-13		IV	75	DC40730-24		IV	27
DC40265-24		IV	25	DC40605-12		IV	75	DC40730-26		IV	27
DC40270-23		IV	67	DC40606-12		IV	75	DC40730-28		IV	27
DC40271-26		IV	67	DC40607-13		IV	75	DC40730-30		IV	27
DC40280-16		IV	7	DC40610-18		IV	40	DC40730-32		IV	27
DC40280-26		IV	7	DC40611-16		IV	40	DC40730-34		IV	27

## Article Code Index / Index Alphanumérique

Code	Ⓣ	Chap.	Page	Code	Ⓣ	Chap.	Page	Code	Ⓣ	Chap.	Page
DC40730-36		IV	27	DC41210-46		IV	82	DC41705-07		IV	84
DC40730-38		IV	27	DC41210-49		IV	82	DC41706-08		IV	84
DC40730-40		IV	27	DC41210-54		IV	82	DC41707-13		IV	84
DC40800-14		IV	68	DC41220-49		IV	82	DC41710-05		IV	84
DC40801-15		IV	68	DC41220-53		IV	82	DC42000-00		IV	94
DC40810-16		IV	46	DC41220-57		IV	82	DC42001-30		IV	94
DC40811-17		IV	46	DC41230-48		IV	82	DC42002-45		IV	94
DC40812-17		IV	46	DC41230-50		IV	82	DC42003-60		IV	94
DC40820-18		IV	48	DC41230-52		IV	82	DC42004-90		IV	94
DC40821-26		IV	48	DC41240-50		IV	82	DC42005-00		IV	94
DC40830-16		IV	57	DC41240-55		IV	82	DC42006-00		IV	94
DC40831-16		IV	57	DC41300-00		IV	84	DC42007-00		IV	94
DC40832-15		IV	57	DC41301-00		IV	84	DC42008-00		IV	94
DC40900-16		IV	56	DC41400-09		IV	80	DC42009-00		IV	94
DC40900-23		IV	107	DC41401-11		IV	80	DC42010-00		IV	94
DC41000-38		IV	76	DC41402-08		IV	80	DC42011-00		IV	94
DC41001-47		IV	76	DC41410-11		IV	81	DC42012-00		IV	94
DC41002-57		IV	76	DC41411-12		IV	81	DC42013-00		IV	94
DC41003-65		IV	76	DC41412-11		IV	81	DC42014-00		IV	94
DC41004-70		IV	76	DC41413-11		IV	81	DC42015-00		IV	94
DC41005-75		IV	76	DC41500-03TI		IV	86	DC42016-00		IV	94
DC41006-92		IV	76	DC41501-03TI		IV	86	DC42017-00		IV	94
DC41007-38		IV	76	DC41502-03TI		IV	86	DC42018-00	+TI	IV	95
DC41008-47		IV	76	DC41503-03TI		IV	86	DC42019-30	+TI	IV	95
DC41009-57		IV	76	DC41504-04TI		IV	86	DC42020-45	+TI	IV	95
DC41010-65		IV	76	DC41505-04TI		IV	86	DC42021-60	+TI	IV	95
DC41011-70		IV	76	DC41506-05TI		IV	86	DC42022-90	+TI	IV	95
DC41012-75		IV	76	DC41507-05TI		IV	86	DC42023-00		IV	95
DC41013-92		IV	76	DC41510-03TI		IV	86	DC42024-00		IV	95
DC41015-30		IV	76	DC41511-03TI		IV	86	DC42025-00		IV	95
DC41016-30		IV	76	DC41512-03TI		IV	86	DC42026-00		IV	95
DC41030-09		IV	83	DC41513-03TI		IV	86	DC42027-00		IV	95
DC41031-13		IV	83	DC41514-04TI		IV	86	DC42028-00		IV	95
DC41032-18		IV	83	DC41515-04TI		IV	86	DC42029-00		IV	95
DC41033-10		IV	83	DC41516-05TI		IV	86	DC42030-00		IV	95
DC41034-14		IV	83	DC41517-05TI		IV	86	DC42031-00		IV	95
DC41035-22		IV	83	DC41520-03	+TI	IV	87	DC42032-00		IV	95
DC41037-08		IV	83	DC41520-25		IV	80	DC42033-00		IV	95
DC41038-12		IV	83	DC41521-03	+TI	IV	87	DC42034-00		IV	95
DC41039-16		IV	83	DC41522-03	+TI	IV	87	DC42035-00		IV	95
DC41040-20		IV	83	DC41523-03	+TI	IV	87	DC42036-00	+TI	IV	96
DC41043-11		IV	83	DC41524-04	+TI	IV	87	DC42037-30	+TI	IV	96
DC41044-16		IV	83	DC41525-04	+TI	IV	87	DC42038-45	+TI	IV	96
DC41045-20		IV	83	DC41526-05	+TI	IV	87	DC42039-60	+TI	IV	96
DC41050-20		IV	83	DC41527-05	+TI	IV	87	DC42040-90	+TI	IV	96
DC41051-28		IV	83	DC41530-08		IV	79	DC42041-00		IV	96
DC41052-00		IV	77	DC41531-09		IV	79	DC42042-00		IV	96
DC41100-23	+TI	IV	78	DC41532-11		IV	79	DC42043-00		IV	96
DC41101-29	+TI	IV	78	DC41533-13		IV	79	DC42044-00		IV	96
DC41102-50	+TI	IV	78	DC41534-07		IV	79	DC42045-00		IV	96
DC41103-66	+TI	IV	78	DC41535-08		IV	79	DC42046-00		IV	96
DC41104-70	+TI	IV	78	DC41536-10		IV	79	DC42047-00		IV	96
DC41105-21		IV	78	DC41537-11		IV	79	DC42048-00		IV	96
DC41106-23	+TI	IV	78	DC41600-05		IV	77	DC42049-00		IV	96
DC41107-32	+TI	IV	78	DC41602-05		IV	77	DC42050-00	+TI	IV	96
DC41108-49	+TI	IV	78	DC41603-06		IV	77	DC42051-00	+TI	IV	96
DC41109-64	+TI	IV	78	DC41610-35		IV	88	DC42052-00	+TI	IV	96
DC41111-04		IV	85	DC41611-35		IV	88	DC42053-00		IV	96
DC41114-04		IV	85	DC41612-35		IV	88	DC42054-00		IV	97
DC41121-12		IV	80	DC41613-35		IV	88	DC42055-30		IV	97
DC41121-15		IV	80	DC41700-06		IV	84	DC42056-45		IV	97
DC41200-47		IV	82	DC41701-07		IV	84	DC42057-60		IV	97
DC41200-51		IV	82	DC41702-08		IV	84	DC42058-90		IV	97
DC41200-57		IV	82	DC41703-13		IV	84	DC42059-00		IV	97
DC41210-44		IV	82	DC41704-06		IV	84	DC42060-00		IV	97

## Article Code Index / Index Alphanumérique

Code	Ⓣ	Chap.	Page	Code	Ⓣ	Chap.	Page	Code	Ⓣ	Chap.	Page
DC42061-00		IV	97	DC45901-15		IV	108	DC50110-12		V	6
DC42062-00		IV	97	DC45902-19		IV	108	DC50110-14		V	6
DC42063-00		IV	97	DC45903-14		IV	108	DC50111-18	+TI	V	6
DC42064-00		IV	97	DC45904-15		IV	108	DC50112-21	+TI	V	6
DC42065-00		IV	97	DC45905-15		IV	108	DC50113-23	+TI	V	6
DC42100-11		IV	98	DC45906-19		IV	108	DC50114-25		V	6
DC42101-12		IV	98	DC45907-25		IV	108	DC50120-12		V	6
DC42102-16		IV	98	DC45910-15		IV	108	DC50120-14		V	6
DC42103-12		IV	98	DC45911-20		IV	108	DC50121-18	+TI	V	6
DC42104-13		IV	98	DC45912-22		IV	108	DC50122-21	+TI	V	6
DC42105-13		IV	98	DC45913-25		IV	108	DC50123-23	+TI	V	6
DC42106-15		IV	98	DC45914-30		IV	108	DC50124-25		V	6
DC42107-15		IV	98	DC46021-16		IV	106	DC50130-12		V	6
DC42108-12		IV	98	DC46022-18		IV	106	DC50130-14		V	6
DC42200-13		IV	99	DC46023-21		IV	106	DC50131-18	+TI	V	6
DC42201-13		IV	99	DC46024-24		IV	106	DC50132-21	+TI	V	6
DC42202-13		IV	99	DC46030-16		IV	106	DC50133-23	+TI	V	6
DC42203-12		IV	99	DC46031-21		IV	106	DC50134-25		V	6
DC42204-11		IV	99	DC46141-20		IV	107	DC50140-14		V	5
DC42205-15		IV	99	DC46142-20		IV	107	DC50141-18	+TI	V	5
DC42206-15		IV	99	DC46143-20		IV	107	DC50142-21	+TI	V	5
DC42207-15		IV	99	DC46144-23		IV	107	DC50150-14		V	5
DC42208-12		IV	99	DC46145-20		IV	107	DC50151-18	+TI	V	5
DC42300-14		IV	100	DC46146-23		IV	107	DC50152-21	+TI	V	5
DC42301-14		IV	100	DC46147-23		IV	107	DC50160-14		V	5
DC42302-14		IV	100	DC46200-16		IV	28	DC50161-18	+TI	V	5
DC42303-14		IV	100	DC46200-19		IV	28	DC50162-21	+TI	V	5
DC42304-14		IV	100	DC50000-12		V	4	DC50170-14		V	5
DC42305-17		IV	100	DC50000-14		V	4	DC50171-18	+TI	V	5
DC42306-14		IV	100	DC50001-18		V	4	DC50172-21	+TI	V	5
DC42407-14		IV	100	DC50002-21		V	4	DC50200-12		V	8
DC42411-15		IV	100	DC50003-23		V	4	DC50200-14		V	8
DC42600-16		IV	93	DC50010-12		V	4	DC50201-18		V	8
DC42601-16		IV	93	DC50010-14		V	4	DC50202-21		V	8
DC42602-16		IV	93	DC50011-18		V	4	DC50203-23		V	8
DC42603-16		IV	93	DC50012-21		V	4	DC50210-12		V	8
DC42604-16		IV	93	DC50013-23		V	4	DC50210-14		V	8
DC43710-13		IV	70	DC50020-12		V	4	DC50211-18		V	8
DC43710-18		IV	70	DC50020-14		V	4	DC50212-21		V	8
DC43710-21		IV	70	DC50021-18		V	4	DC50213-23		V	8
DC43710-23		IV	70	DC50022-21		V	4	DC50220-12		V	8
DC43710-25		IV	70	DC50023-23		V	4	DC50220-14		V	8
DC43710-28		IV	70	DC50030-12		V	4	DC50221-18		V	8
DC43711-13		IV	70	DC50030-14		V	4	DC50222-21		V	8
DC43711-18		IV	70	DC50031-18		V	4	DC50223-23		V	8
DC43711-21		IV	70	DC50032-21		V	4	DC50230-12		V	8
DC43711-23		IV	70	DC50033-23		V	4	DC50230-14		V	8
DC43711-25		IV	70	DC50040-14		V	3	DC50231-18		V	8
DC43711-28		IV	70	DC50041-18		V	3	DC50232-21		V	8
DC45000-19		IV	5	DC50042-21		V	3	DC50233-23		V	8
DC45000-25		IV	5	DC50050-14		V	3	DC50240-14		V	7
DC45000-29		IV	5	DC50051-18		V	3	DC50241-18		V	7
DC45001-25		IV	5	DC50052-21		V	3	DC50242-21		V	7
DC45300-00		IV	51	DC50060-14		V	3	DC50250-14		V	7
DC45600-14		IV	59	DC50061-18		V	3	DC50251-18		V	7
DC45601-15		IV	59	DC50062-21		V	3	DC50252-21		V	7
DC45602-15		IV	59	DC50070-14		V	3	DC50260-14		V	7
DC45603-15		IV	59	DC50071-18		V	3	DC50261-18		V	7
DC45604-15		IV	59	DC50072-21		V	3	DC50262-21		V	7
DC45700-14		IV	59	DC50100-12		V	6	DC50270-14		V	7
DC45701-16		IV	59	DC50100-14		V	6	DC50271-18		V	7
DC45702-17		IV	59	DC50101-18	+TI	V	6	DC50272-21		V	7
DC45703-16		IV	59	DC50102-21	+TI	V	6	DC50300-14		V	9
DC45704-17		IV	59	DC50103-23	+TI	V	6	DC50301-18		V	9
DC45900-15		IV	108	DC50104-25		V	6	DC50302-21		V	9

## Article Code Index / Index Alphanumérique

Code	Ⓣ	Chap.	Page	Code	Ⓣ	Chap.	Page	Code	Ⓣ	Chap.	Page
DC50310-14		V	9	DC50522-21		V	13	DC51050-18		V	20
DC50311-18		V	9	DC50530-14		V	13	DC51050-20		V	20
DC50312-21		V	9	DC50531-18		V	13	DC51050-22		V	20
DC50320-14		V	9	DC50532-21		V	13	DC51060-18		V	20
DC50321-18		V	9	DC50540-14		V	14	DC51060-20		V	20
DC50322-21		V	9	DC50541-18		V	14	DC51060-22		V	20
DC50330-14		V	9	DC50542-21		V	14	DC51100-15		V	23
DC50331-18		V	9	DC50543-23		V	14	DC51100-18		V	23
DC50332-21		V	9	DC50550-14		V	14	DC51100-20		V	23
DC50340-12		V	10	DC50551-18		V	14	DC51100-23		V	23
DC50340-14		V	10	DC50552-21		V	14	DC51110-13		V	24
DC50341-18		V	10	DC50553-23		V	14	DC51110-15		V	24
DC50342-21		V	10	DC50560-14		V	14	DC51110-18		V	24
DC50343-23		V	10	DC50561-18		V	14	DC51110-20		V	24
DC50350-12		V	10	DC50562-21		V	14	DC51110-23		V	24
DC50350-14		V	10	DC50563-23		V	14	DC51110-26		V	24
DC50351-18		V	10	DC50570-14		V	14	DC51120-15		V	25
DC50352-21		V	10	DC50571-18		V	14	DC51120-18		V	25
DC50353-23		V	10	DC50572-21		V	14	DC51120-20		V	25
DC50360-12		V	10	DC50573-23		V	14	DC51120-23		V	25
DC50360-14		V	10	DC50610-18	+TI	V	16	DC51130-13		V	26
DC50361-18		V	10	DC50610-21	+TI	V	16	DC51130-15	+TI	V	26
DC50362-21		V	10	DC50610-23	+TI	V	16	DC51130-18	+TI	V	26
DC50363-23		V	10	DC50610-25	+TI	V	16	DC51130-20		V	26
DC50370-12		V	10	DC50611-18	+TI	V	16	DC51130-23		V	26
DC50370-14		V	10	DC50611-21	+TI	V	16	DC51130-26		V	26
DC50371-18		V	10	DC50611-23	+TI	V	16	DC51140-18		V	27
DC50372-21		V	10	DC50611-25	+TI	V	16	DC51140-20		V	27
DC50373-23		V	10	DC50612-18	+TI	V	16	DC51140-23		V	27
DC50400-14		V	11	DC50612-21	+TI	V	16	DC51140-26		V	27
DC50401-18		V	11	DC50612-23	+TI	V	16	DC51140-30		V	27
DC50402-21		V	11	DC50612-25	+TI	V	16	DC51150-18		V	28
DC50410-14		V	11	DC50613-18	+TI	V	16	DC51150-20		V	28
DC50411-18		V	11	DC50613-21	+TI	V	16	DC51150-23		V	28
DC50412-21		V	11	DC50613-23	+TI	V	16	DC51150-26		V	28
DC50420-14		V	11	DC50613-25	+TI	V	16	DC51150-30		V	28
DC50421-18		V	11	DC50614-18		V	17	DC51160-15		V	29
DC50422-21		V	11	DC50616-23		V	17	DC51160-18		V	29
DC50430-14		V	11	DC50620-23		V	18	DC51160-20		V	29
DC50431-18		V	11	DC50621-23		V	18	DC51160-23		V	29
DC50432-21		V	11	DC50622-23		V	18	DC51160-26		V	29
DC50440-14		V	12	DC50623-23		V	18	DC51160-30		V	29
DC50441-18		V	12	DC50630-19	+TI	V	15	DC51170-16		V	30
DC50442-21		V	12	DC50631-19	+TI	V	15	DC51170-18		V	30
DC50443-23	+TI	V	12	DC50632-19	+TI	V	15	DC51170-20		V	30
DC50450-14		V	12	DC50633-19	+TI	V	15	DC51170-24		V	30
DC50451-18		V	12	DC50634-23	+TI	V	15	DC51170-26		V	30
DC50452-21		V	12	DC50635-23	+TI	V	15	DC51170-30		V	30
DC50453-23	+TI	V	12	DC50636-23	+TI	V	15	DC51171-20		V	30
DC50460-14		V	12	DC50637-23	+TI	V	15	DC51171-24		V	30
DC50461-18		V	12	DC50640-25	+TI	V	15	DC51171-26		V	30
DC50462-21		V	12	DC50641-25	+TI	V	15	DC51180-15		V	32
DC50463-23	+TI	V	12	DC50642-25	+TI	V	15	DC51180-18		V	32
DC50470-14		V	12	DC50643-25	+TI	V	15	DC51180-20		V	32
DC50471-18		V	12	DC50661-14		V	17	DC70400-15	VII	8	
DC50472-21		V	12	DC50662-14		V	17	DC70400-25	VII	8	
DC50473-23	+TI	V	12	DC50663-14		V	17	DC70500-00	VII	3	
DC50500-14		V	13	DC50664-14		V	17	DC70600-00	VII	3	
DC50501-18		V	13	DC51000-23		V	22	DC70600-01	VII	3	
DC50502-21		V	13	DC51010-24	+TI	V	21	DC70700-00	VII	3	
DC50510-14		V	13	DC51010-27	+TI	V	21	DC70800-26	VII	3	
DC50511-18		V	13	DC51011-24	+TI	V	21	DC70810-26	VII	3	
DC50512-21		V	13	DC51011-27	+TI	V	21	DC70820-26	VII	3	
DC50520-14		V	13	DC51012-24	+TI	V	21	DC71300-02	VII	10	
DC50521-18		V	13	DC51012-27	+TI	V	21	DC71300-05	VII	10	

## Article Code Index / Index Alphanumérique

Code	Ⓣ	Chap.	Page	Code	Ⓣ	Chap.	Page	Code	Ⓣ	Chap.	Page
DC71310-02		VII	10	DC71440-20		VII	5	J64330		VI	10
DC71320-02		VII	10	DC71440-25		VII	5	J64350		VI	10
DC71320-08		VII	9	DC71440-30		VII	5	J64380		VI	10
DC71321-08		VII	9	DC71440-35		VII	5	J64384		VI	12
DC71330-03		VII	11	DC71440-40		VII	5	J643850		VI	12
DC71340-07		VII	12	DC71440-45		VII	5	J64386		VI	12
DC71340-08		VII	12	DC71440-50		VII	5	J64390		VI	12
DC71340-09		VII	12	DC71450-05		VII	5	J643950		VI	12
DC71340-10		VII	12	DC71450-10		VII	5	J64400		VI	13
DC71350-03		VII	14	DC71450-15		VII	5	J644005		VI	13
DC71350-04		VII	14	DC71450-20		VII	5	J64410		VI	12
DC71350-05		VII	14	DC71450-25		VII	5	J64412		VI	11
DC71350-06		VII	14	DC71450-30		VII	5	J64414		VI	11
DC71350-07		VII	14	DC71450-35		VII	5	J64416		VI	11
DC71350-08		VII	14	DC71450-40		VII	5	J64418		VI	11
DC71350-09		VII	14	DC71450-45		VII	5	J64422		VI	11
DC71350-10		VII	14	DC71450-50		VII	5	J64490		VI	14
DC71350-11		VII	14	DC71500-00		VII	17	J644950		VI	14
DC71350-12		VII	14	DC71600-12		VII	7	J644960		VI	14
DC71350-13		VII	14	DC71700-24		V	31	J644970		VI	14
DC71350-14		VII	14	DC71800-00		VII	13	J644980		VI	14
DC71360-03		VII	15	DC72300-04		VII	6	J68010		VI	17
DC71360-05		VII	15	DC72301-04		VII	6	J68012		VI	17
DC71360-07		VII	15	DC72302-05		VII	6	J68015		VI	17
DC71361-03		VII	15	G306300		V	33	J68020		VI	17
DC71361-05		VII	15	G30640		V	33	J68022		VI	15
DC71361-07		VII	15	J16240		III	50	J68024		VI	15
DC71370-20		VII	16	J16245		III	50	J68026		VI	15
DC71370-40		VII	16	J24140		VI	4	J68028		VI	15
DC71380-50		VII	17	J24150		VI	4	J68030		VI	15
DC71410-05		VII	5	J24160		VI	4	J68040		VI	15
DC71410-10		VII	5	J24170		VI	4	J68050		VI	15
DC71410-15		VII	5	J24180		VI	4	J68060		VI	15
DC71410-20		VII	5	J241810		VI	4	J68062		VI	16
DC71410-25		VII	5	J241811		VI	4	J68064		VI	16
DC71410-30		VII	5	J24280		VI	5	J68066		VI	16
DC71410-35		VII	5	J24282		VI	5	J68068		VI	16
DC71410-40		VII	5	J24284		VI	5	J68090		VI	19
DC71410-45		VII	5	J24290		VI	5	J68100		VI	19
DC71410-50		VII	5	J24300		VI	5	J68110		VI	20
DC71410-70		VII	5	J24310		VI	5	J68120		VI	20
DC71410-90		VII	5	J24320		VI	5	J68210		VI	3
DC71420-05		VII	5	J64020		VI	7	J68220		VI	3
DC71420-10		VII	5	J64030		VI	7	J68230		VI	3
DC71420-15		VII	5	J64040		VI	7	J68240		VI	3
DC71420-20		VII	5	J64060		VI	7	J68275		VI	18
DC71420-25		VII	5	J64070		VI	7	J68280		VI	18
DC71420-30		VII	5	J64080		VI	7	J758200		V	34
DC71420-35		VII	5	J64090		VI	7	J758300		V	34
DC71420-40		VII	5	J64100		VI	7	V78130		VII	19
DC71420-45		VII	5	J64120		VI	7				
DC71420-50		VII	5	J64130		VI	7				
DC71430-05		VII	5	J64190		VI	6				
DC71430-10		VII	5	J64192		VI	6				
DC71430-15		VII	5	J64200		VI	8				
DC71430-20		VII	5	J64210		VI	8				
DC71430-25		VII	5	J64220		VI	8				
DC71430-30		VII	5	J64230		VI	8				
DC71430-35		VII	5	J64240		VI	8				
DC71430-40		VII	5	J64250		VI	8				
DC71430-45		VII	5	J64254		VI	9				
DC71430-50		VII	5	J64256		VI	9				
DC71440-05		VII	5	J64260		VI	6				
DC71440-10		VII	5	J64290		VI	10				
DC71440-15		VII	5	J64310		VI	10				

## Translation Table / Lexique Multilingue

					
Accessories	Accessoires	Zubehör	Accessoires	Accessori	Accesorios
Adjustable	Réglable	Verstellbar	Aanpasbaar	Adeguabile	Ajustable
Adult size	Taille adulte	Erwachsenergröße	Voor Volwassenen	Misura Adulto	Tamaño adulto
Angled	Coudé	Gewinkelt	Gehoekt	Piegato	Acodado
Arm	Bras	Arm	Arm	Braccio	Braso
Articulation	Articulation	Gelenkverbindung	Articulatie	Articolazione	Articulación
Atrauma	Atraumatique	Atraumatisch	Atraumatische	Atraumatico	Atraumático
Ball Type	Embout sphérique	Kugelende	Bal Tip	Puntale A Palla	Punta con bola
Blade	Valve	Blatt, Valve	Blad	Valva	Valva
Blunt	Mousse	Stumpf	Stomp	Smusso	Romo
Bone	Os	Knochen	Bot	Ossa	Hueso
Bone rongeur	Gouge	Knochenzange	Guts	Sgorbia	Gubia
Child size	Taille enfant	Kindergröße	Voor Kinderen	Misura Pediatrica	Tamaño niño
Circumflex	Circonflexe	Zirkumflex	Circumflex	Circonflesso	Circunflejo
Counterbalanced	Contre poids	Gegengewichtig	Tegengewicht	Contropeso	Contra peso
Curved	Courbe	Gebogen	Gebogen	Curvo	Curvo
Delicate	Délicat	Ampfindlich	Delicaat	Delicato	Delicado
Depth	Profondeur	Tiefe	Diepte	Profondità	Profundidad
Dissecting	Dissection	Sezierung	Dissectie	Dissezione	Disección
Dissector	Dissecteur	Dissektor	Dissector	Dissettore	Disector
External	Externe	Aussen Liegend	Externe	Esterno	Externo
Fine	Fin	Dünn, Fein	Fijn	Fino	Fino
Fingerplate	Contrôle au doigt	Fingerplatte	Vingercontrole	Controllo Digitale	Control digital
Flat	Plat	Flach, Eben	Plat	Piatto	Plano
Forceps	Pince	Pinzette	Klem	Pinza	Pinza
Hand retractor	Valve à main	Handretractor	Handsperder	Divaricatore A Mano	Separador a mano
Handle	Manche	Griff, Stiel	Handvat	Manico	Mango
Height	Hauteur	Höhe	Hoogte	Altezza	Altura
Hook	Crochet	Haken	Haak	Gancio	Gancho
Infant	Nourisson	Kleinkind	Voor Kleine Kinderen	Bambino	Niño de pecho
Jaws	Mors	Kinnbacken	Tanden	Morso	Boca
Knot pusher	Pousse noeud	Schlingengabel	Knoop Duwer	Stringinodo	Empujador de nudo
Large	Grand	Gross	Groot	Grande	Alto
Left	Gauche	Links	Links	Sinistro	A la Izquierda
Length	Longueur	Länge	Lengte	Lunghezza	Longitud
Ligature	Ligature	Unterbindung	Ligatuur	Ligatura	Ligatura
Lung	Poumon	Lunge	Long	Polmone	Pulmón
Medium	Moyen	Mittel	Medium	Medio	Medio
Multipurpose	Multi-fonctions	Mehrzweck	Multie Functie	Funzione Multipla	Multi-función
Needle holder	Porte aiguille	Nadelhalter	Naaldvoerder	Portaghi	Porta agujas
Needle pulling	À saisir les aiguilles	Nadelaufnehmer	Naald Trekken	Pinza Stringi Ago	Para coger las agujas
Newborn	Nouveau né	Neugeborene	Pasgeborene	Neonato	Recién nacido
On Flat	Sur le plat	Flach	Op Het Vlak	Piatto En	En el plano
Opening	Ouverture	Öffnung	Opening	Apertura	Apertura
Pair	Paire	Paar	Paar	Paia	Pár
Prong	Griffe	Zinke	Tanden	Denti	Dientes
Rack	Crémaillère	Gestell	Rek	Cremagliera	Cremallera
Raspatory	Rugine	Schabeisen	Rasp	Raschiatoio	Raspador
Ratchet	Crémaillère	Sperre	Rek	Cremagliera	Cremallera
Retractor	Ecarteur	Retraktor	Sperder	Divaricatore	Separador
Rib contractor	Rapprocheur de côtes	Rippenschliesser	Rib Contractor	Appaltatore DI Costole	Aproximador costal
Right	Droite	Rechts	Rechts	Destra	A la derecha
Ring Handle	A anneaux	Ringgriff	Ringgreep	Ad Anelli	Con anillos
Ring Tip	Embout en anneau	Ringspitze	Ronde Tip	Punta Ad Anelli	Punta con anillo
Rongeur	Gouge	Knochenzange	Guts	Sgorbia	Gubia
Round	Rond	Rund	Ronde Tip	Ton Do	Redondo
Scissors	Ciseaux	Schere	Scharen	Forbici	Tijeras
Serrated	Strié	Gezahnt	Gestreept	Striato	Estriado
Shanks	Branches	Schenkel	Schacht	Ramo	Mango
Sharp	Acéré	Scharf	Scherp	Acute	Acerado
Small	Petit	Klein	Klein	Piccolo	Pequeño
Smooth	Lisse	glatt	Glad	Liscio	Liso
Spatula	Spatule	Spatel	Spatel	Spatula	Espátula
Straight	Droit	Gerade	Recht	Dritto	Recto
Suction tube	Canule d'aspiration	Saugrohr	Aspiratiecanule	Canula DI Aspirazione	Cánula de aspiración
Suture passer	Tire-Fil	Suture passer	Draadgeleider	Passa-fili	Pasa-hilo
Teeth	Dents	Zähne	Tanden	Denti	Dientes
Thermic purge	Purgeur	Thermische	Thermische Purge	Purgatore	Purgador
Thin	Etroit	Dünn	Dun	Ristretto	Estrecho
Thread	Torsade	Faden, Zwirn	Draad	Filo	Hilo
Tip	Bout	Spitze	Tip	Estremità	Punta
Tissue seizing	Préhension	Gewebegrosse	Grip	Presca	Presión
Twister	Pince à torsader	Dreher	Cerclage	Cerchiatura	Pinza para retorcer
Tying forceps	Dissection	Binden	Dissectie	Dissezione	Disección
Vessel	Vaisseau	Gefäß	Ader	Vaso	Vaso
Width	Largeur	Breite / Weite	Breedte	Larghezza	Anchura
Wire Cutter	Coupe-Fils	Drahtschneider	Draadknipper	Taglia Cavo	Alicate para cortar alambre
With / Without	Avec / Sans	Mit / Ohne	Met / Zonder	Con / Senza	Con / Sin

## Alphabetical Index

### A

3 Articulations	Dissecting Tissue Forceps	I-11
	Micro Needle Holders	V-18
4 Articulations	Bone Cutting Forceps	VI-17 to 20
	Cardiovascular Scissors	II-29
	Bone Rongeur	VI-8, 9, 11, 12
4 Articulations Needle Holders	<b>DeBakey</b>	V-21
	<b>Mayo Hegar</b>	V-21
	<b>Ryder</b>	V-21
Abdominal Aorta Clamp	<b>Wylie</b>	IV-21
	<b>Zangler</b>	IV-20
Accessories (Retractors)		III-17
	<b>Bypass+</b>	III-11
	<b>Cardio System</b>	III-23
	<b>Carpentier</b>	III-5
	<b>Direct Vision</b>	III-19
	<b>Dubost</b>	III-13
	<b>Finochietto-Mathey</b>	III-15
	<b>IMA Couëtil Retractor</b>	III-9
<b>Adson</b>	Dissecting Forceps	I-23
<b>Adson Brown</b>	Needle Pulling Forceps	I-18
<b>Allis</b>	Grasping Forceps	IV-108
<b>Allison</b>	Hand Retractor	III-55
<b>Alm</b>	Retractor	III-39
<b>Andrews-Pynchon</b>	Suction Tubes	VII-10
Aneurysm Aortic Clamp	<b>DeBakey</b>	IV-8
<b>Ankeney</b>	Sternal Retractor	III-31
Aorta Coarctation	Clamp	IV-89 to 92
Aortic Clamps		IV-7 to 24
	<b>Bahnson</b>	IV-11
	<b>Beck</b>	IV-16
	<b>Cooley</b>	IV-9, 10, 17
	<b>DeBakey</b>	IV-7, 15
	<b>Diethrich</b>	IV-18
	<b>Kay Lambert</b>	IV-14
	<b>Liddle</b>	IV-13
	<b>Morris</b>	IV-23
	<b>Ochsner</b>	IV-19
	<b>Weber</b>	IV-12
Aortic Punch		VII-6
Aortic Purge Needle		VII-17
Auricula	Hand Retractor	III-44
	<b>Harken Clamp</b>	IV-6
<b>B</b>		
<b>Babcock</b>	Grasping Forceps	IV-106
<b>Bahnson</b>	Aortic Clamp	IV-11
<b>Bailey</b>	Rib Contractor	III-32
<b>Bainbridge</b>	Peripheral Vascular Clamp	IV-34
<b>Baron</b>	Suction Tube	VII-15
Bayonet	Micro Scissors	II-15, 16
<b>Beall</b>	Cardiovascular Scissors	II-22
<b>Beck</b>	Aortic Clamp	IV-16
	Ligature Carrier	IV-68
	Retractor	III-40
<b>Beckmann</b>		III-40
<b>Bengolea</b>	Haemostatic Forceps	IV-105
<b>Beyer</b>	Bone Rongeur	VI-12
<b>Bloch</b>	Hand Retractor	III-57
<b>Bohler</b>	Bone Cutting Forceps	VI-17
<b>Bohler</b>	Bone Rongeur	VI-12
Bone Cutting Forceps		VI-15 to 20
	<b>Bohler</b>	VI-17
	<b>Liston</b>	VI-15, 16, 19, 20

## Alphabetical Index

	<b>Mac Indoe</b>	VI-17
	<b>Ruskin Liston</b>	VI-18
<b>Boyd</b>	Cardiovascular Scissors	II-26
Bronchus Clamps		IV-50, 51
	<b>Lees</b>	IV-50
	<b>Mathey</b>	IV-51
	<b>Price Thomas</b>	IV-51
<b>Buck Gramcko</b>	Bayonet Micro Scissors	II-15
Bulldog Clamps		IV-76 to 88
	<b>Cooley</b>	IV-79
	<b>DeBakey</b>	IV-78, 80, 83, 85
	<b>Diethrich</b>	IV-82, 83
	<b>Dubost</b>	IV-77
	<b>Glover</b>	IV-84
	<b>Glover (Mini)</b>	IV-86 to 88
	<b>Gregory</b>	IV-80, 81
	<b>Hess</b>	IV-83
	<b>Johns Hopkins</b>	IV-76
	<b>Santulli</b>	IV-80
Bulldog Ring Handle Clamps		IV-73 to 75
	<b>Kelly</b>	IV-73
	<b>Mosquito</b>	IV-73
	<b>Rankin</b>	IV-73
<b>Burford</b>	Sternal Retractor	III-29, 30
<b>Bypass+</b> Retractor		III-10
	Accessories	III-11
<b>C</b>		
<b>Cardio System</b> Retractor		III-22
	Accessories	III-23
Cardiovascular Scissors		II-17 to 29
	4 Articulations	II-29
	<b>Beall</b>	II-22
	<b>Boyd</b>	II-26
	<b>Carpentier Papillary Muscle</b>	II-28
	<b>Cooley Mayo</b>	II-26
	<b>De Martel</b>	II-23
	<b>DeBakey</b>	II-17, 27
	<b>Diethrich</b>	II-20, 22
	<b>Diethrich-Potts</b>	II-21
	<b>Favaloro</b>	II-22
	<b>Hegemann</b>	II-19
	<b>Lillehei-Potts</b>	II-25
	<b>Mayo Cooley</b>	II-26
	<b>Merveilleux</b>	II-24
	<b>Potts-Smith</b>	II-18
	<b>Ross</b>	II-25
Carotid Clamp	<b>Javid</b>	IV-28
<b>Carpentier</b>	Dissecting Tissue Forceps	I-10, 11
	Hand Retractor	III-42
	Hook	III-43
	Needle Holder (Ring Handle)	V-22
	Papillary Muscles Clamp	IV-5
	Papillary Muscles Scissors	II-28
<b>Carpentier</b> Retractor		III-3 to 6
	Pediatric Retractor	III-6
	Accessories	III-5
<b>Castaneda</b>	Clamps	IV-94 to 99
<b>Castroviejo</b>	Micro Needle Holder	V-17
<b>Cherry</b>	Supraceliac Aorta Clamp	IV-22
<b>Chevret</b>	Lung Spatula	III-45
<b>Chitwood-DeBakey</b>	Needle Pulling Forceps	I-19
<b>Christophe</b>	Haemostatic Forceps	IV-102



## Alphabetical Index

Clamps (Aortic)		IV-7 to 24
	<b>Bahnson</b>	IV-11
	<b>Beck</b>	IV-16
	<b>Cherry (Supracoeliac Aorta)</b>	IV-22
	<b>Cooley</b>	IV-9, 10, 17
	<b>DeBakey</b>	IV-7, 15
	<b>DeBakey (Aneurysm)</b>	IV-8
	<b>Diethrich</b>	IV-18
	<b>Kay Lambert</b>	IV-14
	<b>Liddle</b>	IV-13
	<b>Morris</b>	IV-23
	<b>Ochsner</b>	IV-19
	<b>Weber</b>	IV-12
	<b>Wylie (Abdominal Aorta)</b>	IV-21
	<b>Zangler (Abdominal Aorta)</b>	IV-20
Clamp (Auricula)	<b>Harken</b>	IV-6
Clamps (Bronchus)		IV-50, 51
	<b>Lees</b>	IV-50
	<b>Mathey</b>	IV-51
	<b>Price Thomas</b>	IV-51
Clamps (Bulldog)		IV-76 to 88
	Ring Handle	IV-73 to 75
Clamps (Delicate)	<b>Cooley</b>	IV-100
	<b>DeBakey</b>	IV-93
Clamps (Intestinal)		IV-52 to 58
	<b>Doyen</b>	IV-54, 55
	<b>Hayes</b>	IV-58
	<b>Kocher</b>	IV-52
	<b>Mayo Robson</b>	IV-53
	<b>Scheibe</b>	IV-56
Clamps (Major Arteries)		IV-28 to 32
	<b>Cooley (Iliac Artery)</b>	IV-30
	<b>Henly (Subclavian Artery)</b>	IV-29
	<b>Javid (Carotid)</b>	IV-28
	Renal Artery	IV-32
	<b>Parry (Femoral-Popliteal Artery)</b>	IV-48
Clamps (Multi-Purpose)		IV-59 to 64
	<b>Cooley</b>	IV-62 to 64
	<b>Dardik</b>	IV-59
	<b>DeBakey</b>	IV-60, 61
Clamp (Papillary Muscles)	<b>Carpentier</b>	IV-5
Clamps (Pediatric)		IV-89 to 100
	<b>Castaneda</b>	IV-94 to 99
	Coarctation (Aorta)	IV-89 to 92
	Patent-Ductus	IV-90 to 92
Clamps (Peripheral Vascular System)		IV-33 to 49
	<b>Bainbridge</b>	IV-34
	<b>Cooley</b>	IV-40, 41, 47
	<b>Dale</b>	IV-44
	<b>DeBakey</b>	IV-33, 38 et 39
	<b>Derra</b>	IV-45, 46
	<b>Gregory (Profunda Vascular System)</b>	IV-49
	<b>Glover</b>	IV-42
	<b>Leland Jones</b>	IV-36
	<b>Pean</b>	IV-35
	<b>Potts</b>	IV-37
	<b>Wylie</b>	IV-43
Clamps (Vena Cava)		IV-25 to 27
	<b>Cooley</b>	IV-26, 27
	<b>Satinsky</b>	IV-25
<b>Cooley</b>	Aortic Clamp	IV-9, 10, 17
	Bulldog	IV-79

## Alphabetical Index

	Delicate Clamp	IV-100
	Iliac Artery Clamp	IV-30
	Ligature Carrier	IV-69
	Mitral Valve Hand Retractor	III-37
	Multi-Purpose Clamp	IV-62 to 64
	Peripheral Vascular Clamp	IV-40, 41, 47
	Sternal Retractor	III-26 to 28
	Suction Tube	VII-12
	Vena Cava Clamp	IV-26, 27
<b>Cooley Mayo</b>	Cardiovascular Scissors	II-26
Coronary Testers	<b>DeBakey</b>	VII-5
	<b>Garrett</b>	VII-5
<b>Crile Wood</b>	Ring Handle Needle Holder	V-29
<b>Crile</b>	Haemostatic Forceps	IV-102
<b>Cushing</b>	Hook	III-50
	Needle Pulling Forceps	I-16
<b>D</b>		
<b>Dale</b>	Peripheral Vascular Clamp	IV-44
<b>Dardik</b>	Multi-Purpose Clamp	IV-59
<b>Davidson</b>	Lung Spatula	III-38
<b>Davis</b>	Double Spatula	III-50
<b>Deaver</b>	Lung Spatula	III-56
<b>DeBakey</b>	Aortic Clamp	IV-7, 15
	Bulldog Clamp	IV-78, 80, 83, 85
	Cardiovascular Scissors	II-17, 27
	Aortic Aneurysm Clamp	IV-8
	Delicate Clamp	IV-93
	Dilators (Vascular)	VII-5
	Multi-Purpose Clamp	IV-60, 61
	Coronary Tester	VII-5
	Dissecting Tissue Forceps	I-12, 13
	Ligature Carrier	IV-65, 66
	Micro Tissue Forceps	I-3, 4
	Needle Holder (4 Articulations)	V-21
	Needle Holder (Ring Handle)	V-27, 28
	Peripheral Vascular Clamp	IV-33, 38 et 39
	Suction Tube	VII-11
Delicate Tissue Forceps		I-14, 15
<b>De Martel</b>	Cardiovascular Scissors	II-23
<b>Derra</b>	Peripheral Vascular Clamp	IV-45, 46
<b>Desmarres</b>	Hand Retractor	III-49
<b>Diethrich</b>	Aortic Clamp	IV-18
	Bulldog Clamp	IV-82, 83
	Cardiovascular Scissors	II-20, 22
	Cardiovascular Scissors	II-21
<b>Diethrich-Potts</b>		
Dilators (Vascular)	<b>DeBakey</b>	VII-5
	<b>Garrett</b>	VII-5
<b>Direct Vision Retractor</b>		III-18
	Accessories	III-19
Dissecting Forceps		I-10 to 24
	<b>Adlerkreutz</b>	I-21
	<b>Adson</b>	I-23
	<b>Barraya</b>	I-21
	<b>Carpentier</b>	I-10, 11
	<b>DeBakey</b>	I-12, 13
	<b>Durand</b>	I-21
	<b>Gerald</b>	I-14
	Jeweler Tissue Forceps	I-24
	Micro	I-3 to I-9
	<b>Resano</b>	I-10, 11
Dissectors		IV-70 to 72
	<b>Gemini</b>	IV-70

## Alphabetical Index

	<b>O'Shaugnessy</b>	IV-71
	<b>Redon</b>	IV-72
	<b>Saylor</b>	IV-72
<b>Doyen</b>	Intestinal Clamp	IV-54, 55
	Raspatory	VI-4
<b>Dubost</b>	Bulldog	IV-77
	Hand Retractor	III-52
	Suture Passer	VII-3
<b>Dubost Retractor</b>		III-12
	Accessories	III-13
<b>Duval</b>	Grasping Forceps	IV-107
<b>E</b>		
<b>Echlin</b>	Bone Rongeur	VI-9
Epicardial	Retractor	III-36
<b>F</b>		
<b>Favaloro</b>	Cardiovascular Scissors	II-22
Femoral-Popliteal Clamp	<b>Parry</b>	IV-48
<b>Finochietto</b>	Intercostal Retractor	III-24, 25
<b>Finochietto-Mathey Retractor</b>		III-14, 16
	Accessories	III-15
Forceps (Grasping)		IV-106 to 108
	<b>Allis</b>	IV-108
	<b>Babcock</b>	IV-106
	<b>Duval</b>	IV-107
	<b>Judd Allis</b>	IV-108
Forceps (Haemostatic)		IV-101 to 105
	<b>Bengolea</b>	IV-105
	<b>Christophe</b>	IV-102
	<b>Crile</b>	IV-102
	<b>Halstead</b>	IV-104
	<b>Kelly</b>	IV-101
	<b>Kocher</b>	IV-101
	<b>Leriche</b>	IV-103
Forceps for Cerclage Thread		V-32, 33
Forceps Wire Cutting		V-34
<b>Frazier</b>	Suction Tube	VII-14
<b>Friedmann (Mini)</b>	Bone Rongeur	VI-13
<b>G</b>		
<b>Garrett</b>	Coronary Tester	VII-5
	Vascular Dilator	VII-5
<b>Gemini</b>	Dissector	IV-70
<b>Gerald</b>	Dissecting Forceps	I-14
<b>Gibbon</b>	Rib Contractor	III-33
<b>Gill-Vernet</b>	Hand Retractor	III-48
<b>Glover</b>	Bulldog Clamp	IV-84
	Peripheral Vascular Clamp	IV-42
<b>Glover (Mini)</b>	Bulldog	IV-86 to 88
Grasping Forceps		IV-106 to 108
	<b>Allis</b>	IV-108
	<b>Babcock</b>	IV-106
	<b>Duval</b>	IV-107
	<b>Judd Allis</b>	IV-108
<b>Gregory</b>	Bulldog Clamp	IV-80, 81
	Profunda Vascular System Clamp	IV-49
<b>H</b>		
Haemostatic Forceps		IV-101 to 105
	<b>Bengolea</b>	IV-105
	<b>Christophe</b>	IV-102
	<b>Crile</b>	IV-102
	<b>Halstead</b>	IV-104
	<b>Kelly</b>	IV-101
	<b>Kocher</b>	IV-101

## Alphabetical Index

	<b>Leriche</b>	IV-103
Haemostatic System		VII-7
<b>Halstead</b>	Haemostatic Forceps	IV-104
Hand Retractors		III-37, 38, 44 to 49, 52 to 57
	<b>Allison</b>	III-55
	Auricula	III-44
	<b>Bloch</b>	III-57
	<b>Carpentier</b>	III-42
	<b>Desmarres</b>	III-49
	<b>Dubost</b>	III-52
	<b>Gill-Vernet</b>	III-48
	<b>Kocher-Langenbeck</b>	III-53
	<b>Martin</b>	III-54
	<b>Semb</b>	III-44
	<b>Simon</b>	III-54
<b>Harken</b>	Auricula Clamp	IV-6
<b>Harrington</b>	Lung Spatula	III-46
<b>Hayes</b>	Intestinal Clamp	IV-58
<b>Hegar</b>	Ring Handle Needle Holder	V-25
<b>Hegemann</b>	Cardiovascular Scissors	II-19
<b>Henly</b>	Subclavian Artery Clamp	IV-29
Heparine Needle		VII-8
<b>Hess</b>	Bulldog	IV-83
Holder (Instruments)	<b>Lortat Jacob</b>	VII-19
Hooks		III-43, 50, 51
	<b>Carpentier</b>	III-43
	<b>Cushing</b>	III-50
	<b>Krayenbuhl</b>	III-50
	Mitral	III-51
<b>I</b>		
Iliac Artery Clamp	<b>Cooley</b>	IV-30
<b>IMA Couëtil</b> Retractor		III-8
	Accessories	III-9
	Mini Sternotomy	III-7
Intercostal Retractors		III-14 to 16, 18, 20, 24, 25, 34, 35
Intestinal Clamps		IV-52 to 58
	<b>Doyen</b>	IV-54, 55
	<b>Hayes</b>	IV-58
	<b>Kocher</b>	IV-52
	<b>Mayo Robson</b>	IV-53
	<b>Scheibe</b>	IV-56
<b>J</b>		
<b>Jacobson</b>	Micro Needle Holder	V-15 to 17
	Micro Scissors	II-5 to 11
	Streamline Micro Scissors	II-10, 11
<b>Jameson</b>	Scissors	II-35
<b>Javid</b>	Carotid Clamp	IV-28
Jeweler	Dissecting Forceps	I-24
<b>Johns Hopkins</b>	Bulldog	IV-76
<b>Judd Allis</b>	Grasping Forceps	IV-108
<b>K</b>		
<b>Kay Lambert</b>	Aortic Clamp	IV-14
<b>Kelly</b>	Ring Handle Bulldog	IV-73
	Haemostatic Forceps	IV-101
<b>Kienny</b>	Vein Holder	VII-4
Knot Pusher	Vascular	V-31
<b>Kocher</b>	Haemostatic Forceps	IV-101
	Intestinal Clamp	IV-52
<b>Kocher-Langenbeck</b>	Hand Retractor	III-53
<b>Krayenbuhl</b>	Hook	III-50
<b>Kruz</b>	Rib Contractor	III-33

## Alphabetical Index

### L

<b>Lardenois</b>	Malleable Blades	III-47
<b>Lees</b>	Bronchus Clamp	IV-50
<b>Leksell-Stille</b>	Bone Rongeur	VI-11
<b>Leland Jones</b>	Peripheral Vascular Clamp	IV-36
<b>Lempert</b>	Bone Rongeur	VI-6
<b>Leriche</b>	Haemostatic Forceps	IV-103
<b>Liddle</b>	Aortic Clamp	IV-13
Ligature Carriers		IV-65 to 69
	<b>Beck</b>	IV-68
	<b>Cooley</b>	IV-69
	<b>DeBakey</b>	IV-65, 66
	<b>Semb</b>	IV-67
Ligature Guides		VII-3
<b>Lillehei-Potts</b>	Cardiovascular Scissors	II-25
<b>Liston</b>	Bone Cutting Forceps	VI-15, 16, 19, 20
<b>Lombard</b>	Bone Rongeur	VI-6
<b>Lortat Jacob</b>	Instruments Holder	VII-19
<b>Luer</b>	Connection	VII-17
	Bone Rongeur	VI-14
<b>Luer Friedmann</b>	Bone Rongeur	VI-13
Lung Spatulae		III-38, 44 to 46
	<b>Chevret</b>	III-45
	<b>Davidson</b>	III-38
	<b>Deaver</b>	III-56
	<b>Harrington</b>	III-46
<b>M</b>		
<b>Mac Indoe</b>	Bone Cutting Forceps	VI-17
	Needle Pulling Forceps	I-16
Mammary Artery Retractor	<b>IMA Couëtil</b>	III-8
	<b>IMA Couëtil (Mini Sternotomy)</b>	III-7
<b>Martin</b>	Hand Retractor	III-54
<b>Mathey</b>	Bronchus Clamp	IV-51
<b>Maurer</b>	Raspatory	VI-5
	Rib Shear	VI-3
<b>Mayo</b>	Scissors	II-31, 37
<b>Mayo Cooley</b>	Cardiovascular Scissors	II-26
<b>Mayo Hegar</b>	4 Articulations Needle Holder	V-21
	Ring Handle Needle Holder	V-30
<b>Mayo Lexer</b>	Scissors	II-31, 36
<b>Mayo Robson</b>	Intestinal Clamp	IV-53
<b>Mayo Stille</b>	Scissors	II-31
<b>Merveilleux</b>	Cardiovascular Scissors	II-24
<b>Metzenbaum</b>	Scissors	II-30, 32, 38
<b>Metzenbaum Fino</b>	Scissors	II-33, 39, 40
Micro	Needle Holders	V-3 to 18
Micro Dissecting Forceps		I-3 to I-9
	Ring Tip	I-9
Micro Needle Holders	3 Articulations	V-18
	<b>Castroviejo</b>	V-17
	<b>Jacobson</b>	V-15 to 17
<b>Micro Ryder</b>	Ring Handle Needle Holder	V-24
Micro Scissors		II-3 to 16
	Ball Type	II-12 to 14
	Bayonet	II-15, 16
	<b>Jacobson</b>	II-5 to 11
	Streamline	II-4
	<b>Vannas (Tenotomy)</b>	II-3
Micro Vascular	Ring Handle Needle Holder	V-23
Mitral Valve	Hook	III-51
	<b>Carpentier Retractor</b>	III-3 to 6
	<b>Cooley Hand Retractor</b>	III-37

## Alphabetical Index

<b>Morris</b>	Aortic Clamp	IV-23
<b>Morse Favaloro</b>	Intercostal Retractor	III-21
<b>Mosquito</b>	Ring Handle Bulldog	IV-73
<b>Murphy</b>	Tubing Clamp	VII-18
<b>N</b>		
<b>Natali</b>	Double Spatula	III-50
Needle (Aortic Purge)		VII-17
Needle (Heparine)		VII-8
Needle Holders (4 Articulations)	<b>DeBakey</b>	V-21
	<b>Mayo Hegar</b>	V-21
	<b>Ryder</b>	V-21
Needle Holders (Micro)		V-3 to 18
	3 Articulations	V-18
	<b>Castroviejo</b>	V-17
	<b>Jacobson</b>	V-15 to 17
Needle Holders (Ring Handle)		V-19 to 30
	<b>Carpentier</b>	V-22
	<b>Crile Wood</b>	V-29
	<b>DeBakey</b>	V-28
	<b>DeBakey Fine</b>	V-27
	<b>Hegar</b>	V-25
	<b>Mayo Hegar</b>	V-30
	<b>Micro Ryder</b>	V-24
	Micro Vascular	V-23
	<b>Paris</b>	V-20
	<b>Ryder</b>	V-26
Needle Pulling Forceps		I-16, 17, 18, 19
	<b>Adson Brown</b>	I-18
	<b>Chitwood-DeBakey</b>	I-19
	<b>Cushing</b>	I-16
	<b>Mac Indoe</b>	I-16
	<b>Potts-Smith</b>	I-17
	<b>Wangensteen</b>	I-18
<b>O</b>		
<b>Ochsner</b>	Aortic Clamp	IV-19
<b>Ollier</b>	Raspatories	VI-4
<b>O'Shaugnessy</b>	Dissector	IV-71
<b>P</b>		
Papillary Muscles	<b>Carpentier</b> Clamp	IV-5
	<b>Carpentier</b> Scissors	II-28
<b>Paris</b>	Ring Handle Needle Holder	V-20
<b>Parry</b>	Femoral-Popliteal Clamp	IV-48
Patent-Ductus	Clamp	IV-90 to 92
<b>Pean</b>	Peripheral Vascular Clamp	IV-35
Pediatric	Clamps	IV-89 to 100
	Retractors	III-6, 21, 24, 26 to 28
	<b>Carpentier</b>	III-6
Peripheral Vascular Clamps		IV-33 to 49
	<b>Bainbridge</b>	IV-34
	<b>Cooley</b>	IV-40, 41, 47
	<b>Dale</b>	IV-44
	<b>DeBakey</b>	IV-33, 38 et 39
	<b>Derra</b>	IV-45, 46
	<b>Glover</b>	IV-42
	<b>Leland Jones</b>	IV-36
	<b>Pean</b>	IV-35
	<b>Potts</b>	IV-37
	<b>Wylie</b>	IV-43
<b>Poole</b>	Suction Tube	VII-9
<b>Potts</b>	Peripheral Vascular Clamp	IV-37
<b>Potts-Smith</b>	Cardiovascular Scissors	II-18
	Needle Pulling Forceps	I-17

## Alphabetical Index

<b>Price Thomas</b>	Bronchus Clamp	IV-51
Punch (Aortic)		VII-6
<b>R</b>		
<b>Rankin</b>	Ring Handle Bulldog Clamp	IV-73
Raspatories		VI-4, 5
	<b>Doyen</b>	VI-4
	<b>Maurer</b>	VI-5
	<b>Ollier</b>	VI-4
<b>Redon</b>	Dissector	IV-72
Renal Artery	Clamp	IV-32
<b>Resano</b>	Dissecting Tissue Forceps	I-10, 11
Retractors (Autostatic)		III-3 to 31, 34, 35, 39 to 41
	<b>Alm</b>	III-39
	Articulated-Arms	III-34
	<b>Beckmann</b>	III-40
	<b>Bypass+</b>	III-10
	<b>Carpentier (Pediatric)</b>	III-6
	<b>Carpentier Mitral Valve Sternal Retractor</b>	III-3 to 6
	<b>Direct Vision</b>	III-18
	<b>Dubost</b>	III-12
	Epicardial	III-36
	<b>Finochietto</b>	III-24, 25
	<b>Finochietto-Mathey</b>	III-14, 16
	<b>IMA Couëtil</b>	III-8
	<b>IMA Couëtil (Mini Sternotomy)</b>	III-7
	Intercostal	III-14 to 16, 18, 20, 24, 25, 34, 35
	Pediatric	III-6, 21, 24, 26 to 28
	<b>Scoville</b>	III-35
	Sternal	III-3 to 13, 21 to 23, 26 to 31
	<b>Tuffier</b>	III-20
	<b>Weitlaner</b>	III-41
Retractors (Hand)		III-37, 38, 44 to 49, 52 to 57
	<b>Allison</b>	III-55
	Auricula	III-44
	<b>Bloch</b>	III-57
	<b>Carpentier</b>	III-42
	<b>Desmarres</b>	III-49
	<b>Dubost</b>	III-52
	<b>Gill-Vernet</b>	III-48
	<b>Kocher-Langenbeck</b>	III-53
	<b>Martin</b>	III-54
	<b>Semb</b>	III-44
	<b>Simon</b>	III-54
Retractors (Mitral Valve)	<b>Carpentier Sternal Retractor</b>	III-3 to 6
	<b>Cooley Hand Retractor</b>	III-37
Retractors (Mammary Artery)	<b>IMA Couëtil</b>	III-8
	Mini Sternotomy	III-7
Retractors (Pediatric)		III-6, 21, 24, 26 to 28
	<b>Carpentier</b>	III-6
Retractors Accessories		III-17
<b>Reynolds</b>	Scissors	II-35
Rib Contractors		III-32, 33
	<b>Bailley</b>	III-32
	<b>Gibbon</b>	III-33
	<b>Kruz</b>	III-33
	<b>Sellor</b>	III-32
Rib Shear	<b>Maurer</b>	VI-3
Rongeurs (Bone)		VI-6 to 14
	<b>Beyer</b>	VI-12
	<b>Bohler</b>	VI-12
	<b>Echlin</b>	VI-9
	<b>Friedmann (Mini)</b>	VI-13

## Alphabetical Index

	<b>Leksell-Stille</b>	VI-11
	<b>Lempert</b>	VI-6
	<b>Lombard</b>	VI-6
	<b>Luer</b>	VI-14
	<b>Luer Friedmann</b>	VI-13
	<b>Sicart</b>	VI-10
	<b>Smith-Petersen</b>	VI-11
	<b>Stille</b>	VI-8
	<b>Vincent</b>	VI-10
<b>Ross</b>	Cardiovascular Scissors	II-25
<b>Rumel</b>	Suture Passer	VII-3
<b>Ruskin Liston</b>	Bone Cutting Forceps	VI-18
<b>Ryder</b>	4 Articulations Needle Holder	V-21
<b>Ryder</b>	Ring Handle Needle Holder	V-26
<b>S</b>		
<b>Santulli</b>	Bulldog	IV-80
<b>Satinsky</b>	Vena Cava Clamp	IV-25
<b>Saylor</b>	Dissector	IV-72
<b>Scheibe</b>	Intestinal Clamp	IV-56
<b>Schuhknecht</b>	Suction Tube	VII-16
Scissors	<b>Jameson</b>	II-35
	<b>Mayo</b>	II-31, 37
	<b>Mayo Lexer</b>	II-31, 36
	<b>Mayo Stille</b>	II-31
	<b>Metzenbaum</b>	II-30, 32, 38
	<b>Metzenbaum Fino</b>	II-33, 39, 40
	Micro	II-3 to 16
	<b>Reynolds</b>	II-35
	<b>Stevens</b>	II-30
	<b>Toennis Adson</b>	II-40
	<b>Wagner</b>	II-34
Scissors (Cardiovascular)		II-17 to 29
	<b>Beall</b>	II-22
	<b>Boyd</b>	II-26
	<b>Carpentier Papillary Muscle</b>	II-28
	<b>Cooley Mayo</b>	II-26
	<b>De Martel</b>	II-23
	<b>DeBakey</b>	II-17, 27
	<b>Diethrich</b>	II-20, 22
	<b>Diethrich-Potts</b>	II-21
	<b>Favaloro</b>	II-22
	<b>Hegemann</b>	II-19
	<b>Lillehei-Potts</b>	II-25
	<b>Mayo Cooley</b>	II-26
	<b>Merveilleux</b>	II-24
	<b>Potts-Smith</b>	II-18
	<b>Ross</b>	II-25
<b>Scoville</b>	Retractor	III-35
<b>Sellor</b>	Rib Contractor	III-32
<b>Semb</b>	Hand Retractor	III-44
	Ligature Carrier	IV-67
<b>Sicart</b>	Bone Rongeur	VI-10
<b>Simon</b>	Hand Retractor	III-54
<b>Smith-Petersen</b>	Bone Rongeur	VI-11
Spatula (Double)	<b>Davis</b>	III-50
	<b>Natali</b>	III-50
	<b>Toennis</b>	III-50
Spatulae (Lung)		III-38, 44 to 46
	<b>Chevret</b>	III-45
	<b>Davidson</b>	III-38
	<b>Deaver</b>	III-56
	<b>Harrington</b>	III-46



## Alphabetical Index

Sternal Retractors		III-3 to 13, 21 to 23, 26 to 31
<b>Stevens</b>	Scissors	II-30
<b>Stille</b>	Bone Rongeur	VI-8
Streamline	Jacobson Micro Scissors	II-10, 11
	Micro Scissors	II-4
Stylets		VII-3
Subclavian Artery Clamp	<b>Henly</b>	IV-29
Suction Hook		VII-13
Suction Tubes		VII-9 to 16
	<b>Andrews-Pynchon</b>	VII-10
	<b>Baron</b>	VII-15
	<b>Cooley</b>	VII-12
	<b>DeBakey</b>	VII-11
	<b>Frazier</b>	VII-14
	<b>Poole</b>	VII-9
	<b>Schuhknecht</b>	VII-16
	<b>Yankauer</b>	VII-10
Supraceliac Aorta Clamp	<b>Cherry</b>	IV-22
Suture Passer		VII-3
<b>T</b>		
<b>Toennis</b>	Double Spatula	III-50
Tubing Clamp	<b>Murphy</b>	VII-18
<b>Toennis Adson</b>	Scissors	II-40
<b>Tuffier</b>	Intercostal Retractor	III-20
<b>V</b>		
<b>Vannas</b>	Tenotomy Bayonet Micro Scissors	II-16
	Tenotomy Micro Scissors	II-3
Vascular	Knot Pusher	V-31
Vascular (Peripheral) Clamps		IV-33 to 49
	<b>Bainbridge</b>	IV-34
	<b>Cooley</b>	IV-40, 41, 47
	<b>Dale</b>	IV-44
	<b>DeBakey</b>	IV-33, 38 et 39
	<b>Derra</b>	IV-45, 46
	<b>Glover</b>	IV-42
	<b>Leland Jones</b>	IV-36
	<b>Pean</b>	IV-35
	<b>Potts</b>	IV-37
	<b>Wylie</b>	IV-43
Vein Holder	<b>Kienny</b>	VII-4
Vena Cava Clamps		IV-25 to 27
	<b>Cooley</b>	IV-26, 27
	<b>Satinsky</b>	IV-25
<b>Vincent</b>	Bone Rongeur	VI-10
<b>W</b>		
<b>Wagner</b>	Scissors	II-34
<b>Wangensteen</b>	Needle Pulling Forceps	I-18
<b>Weber</b>	Aortic Clamp	IV-12
<b>Weitlaner</b>	Retractor	III-41
<b>Wylie</b>	Abdominal Aorta Clamp	IV-21
	Peripheral Vascular Clamp	IV-43
<b>Y</b>		
<b>Yankauer</b>	Suction Tube	VII-10
<b>Z</b>		
<b>Zangler</b>	Abdominal Aorta Clamp	IV-20

## Index Alphabétique

### A

3 Articulations	Micro Porte-Aiguilles	V-18
	Pince à Dissection	I-11
4 Articulations	Ciseaux Cardiovasculaires	II-29
	Pince Gouge	VI-8, 9, 11, 12
	Pince Coupante	VI-17 à 20
4 Articulations (Porte-Aiguilles)	<b>DeBakey</b>	V-21
	<b>Mayo Hegar</b>	V-21
	<b>Ryder</b>	V-21
Abdominale (Clamp pour Aorte)	<b>Wylie</b>	IV-21
	<b>Zangler</b>	IV-20
Accessoires pour Ecarteurs		III-17
	<b>Bypass+</b>	III-11
	<b>Cardio System</b>	III-23
	<b>Carpentier</b>	III-5
	<b>Direct Vision</b>	III-19
	<b>Dubost</b>	III-13
	<b>Finochietto-Mathey</b>	III-15
	<b>IMA Couëtil</b>	III-9
<b>Adson</b>	Pince à Dissection	I-23
<b>Adson Brown</b>	Pince pour Aiguilles	I-18
<b>Allis</b>	Pince à Préhension	IV-108
<b>Allison</b>	Ecarteur à Main	III-55
<b>Alm</b>	Ecarteur	III-39
<b>Andrews-Pynchon</b>	Canule d'Aspiration	VII-10
Anévrisme (Clamp Aortique pour)	<b>DeBakey</b>	IV-8
<b>Ankeney</b>	Ecarteur Sternal	III-31
Aortique (Clamp)		IV-7 à 24
	<b>Bahnson</b>	IV-11
	<b>Beck</b>	IV-16
	<b>Cooley</b>	IV-9, 10, 17
	Coarctation	IV-89 à 92
	<b>DeBakey</b>	IV-7, 15
	<b>Diethrich</b>	IV-18
	<b>Kay Lambert</b>	IV-14
	<b>Liddle</b>	IV-13
	<b>Morris</b>	IV-23
	<b>Ochsner</b>	IV-19
	<b>Weber</b>	IV-12
Aortique	Punch	VII-6
	Purge	VII-17
Aspiration (Canules)		VII-9 à 16
	<b>Andrews-Pynchon</b>	VII-10
	<b>Baron</b>	VII-15
	<b>Cooley</b>	VII-12
	<b>DeBakey</b>	VII-11
	<b>Frazier</b>	VII-14
	<b>Poole</b>	VII-9
	<b>Schuhknecht</b>	VII-16
	<b>Yankauer</b>	VII-10
<b>B</b>		
<b>Babcock</b>	Pince à Préhension	IV-106
<b>Bahnson</b>	Clamp Aortique	IV-11
<b>Bailey</b>	Rapprocheur de Côtes	III-32
<b>Bainbridge</b>	Clamp Vasculaire Périphérique	IV-34
Baïonnette	Micro Ciseaux	II-15, 16
<b>Baron</b>	Canule d'Aspiration	VII-15
<b>Beall</b>	Ciseaux Cardiovasculaires	II-22
<b>Beck</b>	Clamp Aortique	IV-16
	Passe-Fils	IV-68
<b>Beckmann</b>	Ecarteur	III-40
<b>Bengolea</b>	Pince Hémostatique	IV-105

## Index Alphabétique

<b>Beyer</b>	Pince Gouge	VI-12
<b>Bloch</b>	Ecarteur à Main	III-57
<b>Bohler</b>	Pince Gouge	VI-12
	Pince Coupante	VI-17
<b>Boyd</b>	Ciseaux Cardiovasculaires	II-26
Bronches (Clamps)		IV-50, 51
	<b>Lees</b>	IV-50
	<b>Mathey</b>	IV-51
	<b>Price Thomas</b>	IV-51
Buck Gramcko	Micro Ciseaux Baïonnette	II-15
Bulldog (Clamps)		IV-76 à 88
	<b>Cooley</b>	IV-79
	<b>DeBakey</b>	IV-78, 80, 83, 85
	<b>Diethrich</b>	IV-82, 83
	<b>Dubost</b>	IV-77
	<b>Glover</b>	IV-84
	Mini <b>Glover</b>	IV-86 à 88
	<b>Gregory</b>	IV-80, 81
	<b>Hess</b>	IV-83
	<b>Johns Hopkins</b>	IV-76
	<b>Santulli</b>	IV-80
Bulldog (Clamps à Anneaux)		IV-73 à 75
	<b>Kelly</b>	IV-73
	<b>Mosquito</b>	IV-73
	<b>Rankin</b>	IV-73
<b>Burford</b>	Ecarteur Sternal	III-29, 30
<b>Bypass+</b> (Ecarteur)		III-10
	Accessoires	III-11
<b>C</b>		
Canules à Héparine		VII-8
Canules d'Aspiration		VII-9 à 16
	<b>Andrews-Pynchon</b>	VII-10
	<b>Baron</b>	VII-15
	<b>Cooley</b>	VII-12
	<b>DeBakey</b>	VII-11
	<b>Frazier</b>	VII-14
	<b>Poole</b>	VII-9
	<b>Schuhknecht</b>	VII-16
	<b>Yankauer</b>	VII-10
<b>Cardio System</b> (Ecarteur)		III-22
	Accessoires	III-23
Carotide (Clamp)	<b>Javid</b>	IV-28
<b>Carpentier</b>	Ciseaux (Muscles Papillaires)	II-28
	Clamp (Muscles Papillaires)	IV-5
	Crochet	III-43
	Ecarteur à Main	III-42
	Pince à Dissection	I-10, 11
	Porte-Aiguilles à Anneaux	V-22
<b>Carpentier</b> (Ecarteur)		III-3 à 6
	Accessoires	III-5
	Pédiatrique	III-6
<b>Castaneda</b>	Clamps	IV-94 à 99
<b>Castroviejo</b>	Micro Porte-Aiguilles	V-17
Chausse-Veine	<b>Kienny</b>	VII-4
<b>Cherry</b>	Clamp (Aorte Supracœliaque)	IV-22
<b>Chevret</b>	Spatule à Poumon	III-45
<b>Chitwood-DeBakey</b>	Pince pour Aiguilles	I-19
<b>Christophe</b>	Pince Hémostatique	IV-102
Ciseaux	<b>Jameson</b>	II-35
	<b>Mayo</b>	II-31, 37
	<b>Mayo Lexer</b>	II-31, 36
	<b>Mayo Stille</b>	II-31

## Index Alphabétique

	<b>Metzenbaum</b>	II-30, 32, 38
	<b>Metzenbaum Fino</b>	II-33, 39, 40
	<b>Reynolds</b>	II-35
	<b>Stevens</b>	II-30
	<b>Toennis Adson</b>	II-40
	<b>Wagner</b>	II-34
Ciseaux Cardiovasculaires		II-17 à 29
	4 Articulations	II-29
	<b>Beall</b>	II-22
	<b>Boyd</b>	II-26
	<b>Carpentier</b> (Muscles Papillaires)	II-28
	<b>Cooley Mayo</b>	II-26
	<b>De Martel</b>	II-23
	<b>DeBakey</b>	II-17, 27
	<b>Diethrich</b>	II-20, 22
	<b>Diethrich-Potts</b>	II-21
	<b>Favaloro</b>	II-22
	<b>Hegemann</b>	II-19
	<b>Lillehei-Potts</b>	II-25
	<b>Mayo Cooley</b>	II-26
	<b>Merveilleux</b>	II-24
	<b>Potts-Smith</b>	II-18
	<b>Ross</b>	II-25
Ciseaux Micro		II-3 à 16
	Baïonnette	II-15, 16
	Extrémité Sphérique	II-12 à 14
	<b>Jacobson</b>	II-5 à 11
	Streamline	II-4
	<b>Vannas</b> (Ténotomie)	II-3
Clamps Aortiques		IV-7 à 24
	<b>Bahnson</b>	IV-11
	<b>Beck</b>	IV-16
	<b>Cherry</b> (Aorte Supracœliaque)	IV-22
	<b>Cooley</b>	IV-9, 10, 17
	<b>DeBakey</b>	IV-7, 15
	<b>DeBakey (Anévrisme)</b>	IV-8
	<b>Diethrich</b>	IV-18
	<b>Kay Lambert</b>	IV-14
	<b>Liddle</b>	IV-13
	<b>Morris</b>	IV-23
	<b>Ochsner</b>	IV-19
	<b>Weber</b>	IV-12
	<b>Wylie</b> (Aorte Abdominale)	IV-21
	<b>Zangler</b> (Aorte Abdominale)	IV-20
Clamps (Bronches)		IV-50, 51
	<b>Lees</b>	IV-50
	<b>Mathey</b>	IV-51
	<b>Price Thomas</b>	IV-51
Clamps Bulldog		IV-76 à 88
	<b>Cooley</b>	IV-79
	<b>DeBakey</b>	IV-78, 80, 83, 85
	<b>Diethrich</b>	IV-82, 83
	<b>Dubost</b>	IV-77
	<b>Glover</b>	IV-84
	Mini <b>Glover</b>	IV-86 à 88
	<b>Gregory</b>	IV-80, 81
	<b>Hess</b>	IV-83
	<b>Johns Hopkins</b>	IV-76
	<b>Santulli</b>	IV-80
Clamps Bulldog à Anneaux		IV-73 à 75
	<b>Kelly</b>	IV-73
	<b>Mosquito</b>	IV-73

## Index Alphabétique

	<b>Rankin</b>	IV-73
Clamps Délicats	<b>Cooley</b>	IV-100
	<b>DeBakey</b>	IV-93
Clamps Gros Vaisseaux		IV-28 à 32
	Artère Rénale	IV-32
	<b>Cooley</b> (Artère Iliaque)	IV-30
	<b>Henly</b> (Artère Sous-Clavière)	IV-29
	<b>Javid</b> (Carotide)	IV-28
	<b>Parry</b> (Artère Fémoro-Poplitée)	IV-48
Clamps Intestinaux		IV-52 à 58
	<b>Doyen</b>	IV-54, 55
	<b>Hayes</b>	IV-58
	<b>Kocher</b>	IV-52
	<b>Mayo Robson</b>	IV-53
	<b>Scheibe</b>	IV-56
Clamps Multi-Fonctions		IV-59 à 64
	<b>Cooley</b>	IV-62 à 64
	<b>Dardik</b>	IV-59
	<b>DeBakey</b>	IV-60, 61
Clamp (Oreillette)	<b>Harken</b>	IV-6
Clamp (Muscles Papillaires)	<b>Carpentier</b>	IV-5
Clamps Pédiatriques		IV-89 à 100
	Canal Artériel Persistant	IV-90 à 92
	<b>Castaneda</b>	IV-94 à 99
	Coarctation (Aorte)	IV-89 à 92
Clamps Vasculaire Périphérique		IV-33 à 49
	<b>Bainbridge</b>	IV-34
	<b>Cooley</b>	IV-40, 41, 47
	<b>Dale</b>	IV-44
	<b>DeBakey</b>	IV-33, 38 et 39
	<b>Derra</b>	IV-45, 46
	<b>Gregory</b> (Vaisseaux Profonds)	IV-49
	<b>Glover</b>	IV-42
	<b>Leland Jones</b>	IV-36
	<b>Pean</b>	IV-35
	<b>Potts</b>	IV-37
	<b>Wylie</b>	IV-43
Clamps Veine Cave		IV-25 à 27
	<b>Cooley</b>	IV-26, 27
	<b>Satinsky</b>	IV-25
<b>Cooley</b>	Canule d'Aspiration	VII-12
	Bulldog	IV-79
	Clamp Aortique	IV-9, 10, 17
	Clamp Délicat	IV-100
	Clamp Multi-Fonctions	IV-62 à 64
	Clamp (Artère Iliaque)	IV-30
	Clamp Veine Cave	IV-26, 27
	Clamp Vasculaire Périphérique	IV-40, 41, 47
	Ecarteur à Main (Valve Mitrale)	III-37
	Ecarteur Sternal	III-26 à 28
	Passe-Fils	IV-69
<b>Cooley Mayo</b>	Ciseaux Cardiovasculaires	II-26
Costotome	<b>Maurer</b>	VI-3
<b>Crile Wood</b>	Porte-Aiguilles à Anneaux	V-29
<b>Crile</b>	Pince Hémostatique	IV-102
Crochets		III-43, 50, 51
	<b>Carpentier</b>	III-43
	<b>Cushing</b>	III-50
	<b>Krayenbuhl</b>	III-50
	Mitral	III-51
Crochet d'Aspiration		VII-13
<b>Cushing</b>	Crochet	III-50

## Index Alphabétique

	Pince pour Aiguilles	I-16
<b>D</b>		
<b>Dale</b>	Clamp Vasculaire Périphérique	IV-44
<b>Dardik</b>	Clamp Multi-Fonctions	IV-59
<b>Davidson</b>	Spatule à Poumon	III-38
<b>Davis</b>	Spatule Double	III-50
<b>Deaver</b>	Spatule à Poumon	III-56
<b>DeBakey</b>	Canule d'Aspiration	VII-11
	Bulldog	IV-78, 80, 83, 85
	Ciseaux Cardiovasculaires	II-17, 27
	Clamp Aortique	IV-7, 15
	Clamp Aortique (Anévrisme)	IV-8
	Clamp Délicat	IV-93
	Clamp Multi-Fonctions	IV-60, 61
	Clamp Vasculaire Périphérique	IV-33, 38 et 39
	Dilatateur Vasculaire	VII-5
	Micro Pince à Dissection	I-3, 4
	Passe-Fils	IV-65, 66
	Pince à Dissection	I-12, 13
	Porte-Aiguilles 4 Articulations	V-21
	Porte-Aiguilles à Anneaux	V-27, 28
	Testeurs Coronariens	VII-5
<b>De Martel</b>	Ciseaux Cardiovasculaires	II-23
<b>Derra</b>	Clamp Vasculaire Périphérique	IV-45, 46
<b>Desmarres</b>	Ecarteur à Main	III-49
<b>Diethrich</b>	Bulldog	IV-82, 83
	Ciseaux Cardiovasculaires	II-20, 22
	Clamp Aortique	IV-18
<b>Diethrich-Potts</b>	Ciseaux Cardiovasculaires	II-21
Dilatateurs Vasculaires	<b>DeBakey</b>	VII-5
	<b>Garrett</b>	VII-5
<b>Direct Vision</b> (Ecarteur)		III-18
	Accessoires	III-19
Dissecteurs		IV-70 à 72
	<b>Gemini</b>	IV-70
	<b>O'Shaugnessy</b>	IV-71
	<b>Redon</b>	IV-72
	<b>Saylor</b>	IV-72
<b>Doyen</b>	Clamp Intestinal	IV-54, 55
	Rugine	VI-4
<b>Dubost</b> (Ecarteur)		III-12
	Accessoires	III-13
<b>Dubost</b>	Bulldog	IV-77
	Ecarteur à Main	III-52
	Tire-Fils	VII-3
<b>Duval</b>	Pince à Préhension	IV-107
<b>E</b>		
Ecarteurs Autostatiques		III-3 à 36
	<b>Alm</b>	III-39
	<b>Ankeney</b>	III-31
	<b>Beckmann</b>	III-40
	Bras Articulés	III-34
	<b>Burford</b>	III-29, 30
	<b>Bypass+</b>	III-10
	<b>Cardio System</b>	III-22
	<b>Carpentier</b> (Pediatric)	III-6
	<b>Carpentier</b> (Valve Mitrale)	III-3 à 6
	<b>Cooley</b>	III-26 à 28
	<b>Direct Vision</b>	III-18
	<b>Dubost</b>	III-12
	Epicardial	III-36
	<b>Finochietto</b>	III-24, 25

## Index Alphabétique

	<b>Finochietto-Mathey</b>	III-14, 16
	<b>IMA Couëtil</b> (Artère Mammaire)	III-8
	<b>IMA Couëtil</b> (Mini-Sternotomie)	III-7
	Intercostaux	III-14 à 16, 18, 20, 24, 25, 34, 35
	<b>Morse Favalaro</b>	III-21
	Pédiatriques	III-6, 21, 24, 26 à 28
	<b>Scoville</b>	III-35
	Sternaux	III-3 à 13, 21 à 23, 26 à 31
	<b>Tuffier</b>	III-20
	<b>Weitlaner</b>	III-41
Ecarteurs à Main		III-37, 38, 44 à 49, 52 à 57
	<b>Carpentier</b>	III-42
	<b>Allison</b>	III-55
	<b>Bloch</b>	III-57
	<b>Desmarres</b>	III-49
	<b>Dubost</b>	III-52
	<b>Gill-Vernet</b>	III-48
	<b>Kocher-Langenbeck</b>	III-53
	<b>Martin</b>	III-54
	Oreillette	III-44
	<b>Semb</b>	III-44
	<b>Simon</b>	III-54
Ecarteurs (Artère Mammaire)	<b>IMA Couëtil</b>	III-8
	Mini-Sternotomie	III-7
Ecarteurs (Valve Mitrale)	<b>Carpentier</b>	III-3 à 6
	<b>Cooley</b> (Ecarteur à Main)	III-37
Ecarteurs Pédiatriques		III-6, 21, 24, 26 à 28
	<b>Carpentier</b>	III-6
Ecarteurs (Accessoires)		III-17
<b>Echlin</b>	Pince Gouge	VI-9
Epicardial	Ecarteur	III-36
<b>F</b>		
<b>Favaloro</b>	Ciseaux Cardiovasculaires	II-22
Fémoro-Poplité (Clamp)	<b>Parry</b>	IV-48
<b>Finochietto</b>	Ecarteur Intercostal	III-24, 25
<b>Finochietto-Mathey</b> (Ecarteur)		III-14, 16
	Accessoires	III-15
<b>Frazier</b>	Canule d'Aspiration	VII-14
<b>Friedmann</b> (Mini)	Pince Gouge	VI-13
<b>G</b>		
<b>Garrett</b>	Testeur Coronarien	VII-5
	Dilatateur Vasculaire	VII-5
<b>Gemini</b>	Dissecteur	IV-70
<b>Gerald</b>	Pince à Dissection	I-14
<b>Gibbon</b>	Rapprocheur de Côtes	III-33
<b>Gill-Vernet</b>	Ecarteur à Main	III-48
<b>Glover</b>	Bulldog	IV-84
	Clamp Vasculaire Périphérique	IV-42
<b>Glover</b> (Mini)	Bulldog	IV-86 à 88
Gouges (Pincés)		VI-6 à 14
	<b>Beyer</b>	VI-12
	<b>Bohler</b>	VI-12
	<b>Echlin</b>	VI-9
	<b>Friedmann</b> (Mini)	VI-13
	<b>Leksell-Stille</b>	VI-11
	<b>Lempert</b>	VI-6
	<b>Lombard</b>	VI-6
	<b>Luer</b>	VI-14
	<b>Luer Friedmann</b>	VI-13
	<b>Sicart</b>	VI-10
	<b>Smith-Petersen</b>	VI-11
	<b>Stille</b>	VI-8

## Index Alphabétique

	<b>Vincent</b>	VI-10
<b>Gregory</b>	Bulldog	IV-80, 81
	Clamp Vaisseaux Profonds	IV-49
<b>H</b>		
<b>Halstead</b>	Pince Hémostatique	IV-104
<b>Harken</b>	Clamp (Oreillette)	IV-6
<b>Harrington</b>	Spatule à Poumon	III-46
<b>Hayes</b>	Clamp Intestinal	IV-58
<b>Hegar</b>	Porte-Aiguilles à Anneaux	V-25
<b>Hegemann</b>	Ciseaux Cardiovasculaires	II-19
	Hémostatique (Système)	VII-7
	Hémostatiques (Pincés)	IV-101 à 105
	<b>Bengolea</b>	IV-105
	<b>Christophe</b>	IV-102
	<b>Crile</b>	IV-102
	<b>Halstead</b>	IV-104
	<b>Kelly</b>	IV-101
	<b>Kocher</b>	IV-101
	<b>Leriche</b>	IV-103
<b>Henly</b>	Clamp (Artère Sous-Clavière)	IV-29
	Héparine (Canules à)	VII-8
<b>Hess</b>	Bulldog	IV-83
	Horloger	I-24
<b>I</b>		
	<b>Cooley</b>	IV-30
<b>Iliaque (Clamp)</b>		III-8
<b>IMA Couëtil (Ecarteur)</b>	Accessoires	III-9
	Mini-Sternotomie	III-7
	Intercostaux (Ecarteurs)	III-14 à 16, 18, 20, 24, 25, 34, 35
	Intestinaux (Clamps)	IV-52 à 58
	<b>Doyen</b>	IV-54, 55
	<b>Hayes</b>	IV-58
	<b>Kocher</b>	IV-52
	<b>Mayo Robson</b>	IV-53
	<b>Scheibe</b>	IV-56
<b>J</b>		
<b>Jacobson</b>	Micro Ciseaux	II-5 à 11
	Micro Ciseaux Streamline	II-10, 11
	Micro Porte-Aiguilles	V-15 à 17
<b>Jameson</b>	Ciseaux	II-35
<b>Javid</b>	Clamp pour Carotide	IV-28
<b>Johns Hopkins</b>	Bulldog	IV-76
<b>Judd Allis</b>	Pince à Préhension	IV-108
<b>K</b>		
<b>Kay Lambert</b>	Clamp Aortique	IV-14
<b>Kelly</b>	Bulldog à Anneaux	IV-73
	Pince Hémostatique	IV-101
<b>Kienny</b>	Chausse-Veine	VII-4
<b>Kocher</b>	Clamp Intestinal	IV-52
	Pince Hémostatique	IV-101
<b>Kocher-Langenbeck</b>	Ecarteur à Main	III-53
<b>Krayenbuhl</b>	Crochet	III-50
<b>Kruz</b>	Rapprocheur de Côtes	III-33
<b>L</b>		
<b>Lardenois</b>	Lame Malléable	III-47
<b>Lees</b>	Clamp à Bronches	IV-50
<b>Leksell-Stille</b>	Pince Gouge	VI-11
<b>Leland Jones</b>	Clamp Vasculaire Périphérique	IV-36
<b>Lempert</b>	Pince Gouge	VI-6
<b>Leriche</b>	Pince Hémostatique	IV-103
<b>Liddle</b>	Clamp Aortique	IV-13
<b>Lillehei-Potts</b>	Ciseaux Cardiovasculaires	II-25



## Index Alphabétique

<b>Liston</b>	Pince Coupante	VI-15, 16, 19, 20
<b>Lombard</b>	Pince Gouge	VI-6
<b>Lortat Jacob</b>	Porte-Instruments	VII-19
<b>Luer</b>	Embout	VII-17
	Pince Gouge	VI-14
<b>Luer Friedmann</b>	Pince Gouge	VI-13
<b>M</b>		
<b>Mac Indoe</b>	Pince Coupante	VI-17
	Pince pour Aiguilles	I-16
Mammaire (Ecarteur pour Artère)	<b>IMA Couëtil</b>	III-8
	Mini-Sternotomie	III-7
<b>Martin</b>	Ecarteur à Main	III-54
<b>Mathey</b>	Clamp à Bronches	IV-51
<b>Maurer</b>	Costotome	VI-3
	Rugine	VI-5
<b>Mayo</b>	Ciseaux	II-31, 37
<b>Mayo Cooley</b>	Ciseaux Cardiovasculaires	II-26
<b>Mayo Hegar</b>	Porte-Aiguilles 4 Articulations	V-21
	Porte-Aiguilles à Anneaux	V-30
<b>Mayo Lexer</b>	Ciseaux	II-31, 36
<b>Mayo Robson</b>	Clamp Intestinal	IV-53
<b>Mayo Stille</b>	Ciseaux	II-31
<b>Merveilleux</b>	Ciseaux Cardiovasculaires	II-24
<b>Metzenbaum</b>	Ciseaux	II-30, 32, 38
<b>Metzenbaum Fino</b>	Ciseaux	II-33, 39, 40
Micro	Porte-Aiguilles	V-3 à 18
Micro Ciseaux		II-3 à 16
	Baïonnette	II-15, 16
	Extrémité Sphérique	II-12 à 14
	<b>Jacobson</b>	II-5 à 11
	Streamline	II-4
	<b>Vannas (Ténotomie)</b>	II-3
Micro Pincés à Dissection		I-3 à I-9
	Mors à anneaux	I-9
Micro Porte-Aiguilles	3 Articulations	V-18
	<b>Castroviejo</b>	V-17
	<b>Jacobson</b>	V-15 à 17
<b>Micro Ryder</b>	Porte-Aiguilles à Anneaux	V-24
Micro Vasculaire	Porte-Aiguilles à Anneaux	V-23
Mitrale (Valve)	Crochet	III-51
	<b>Cooley (Ecarteur à Main)</b>	III-37
	<b>Carpentier (Ecarteur sternal)</b>	III-3 à 6
<b>Morris</b>	Clamp Aortique	IV-23
<b>Morse Favalaro</b>	Ecarteur Intercostal	III-21
<b>Mosquito</b>	Bulldog à Anneaux	IV-73
Multi-Fonctions	Clamps	IV-59 à 64
<b>Murphy</b>	Presse Tube	VII-18
<b>N</b>		
<b>Natali</b>	Spatule Double	III-50
<b>O</b>		
<b>Ochsner</b>	Clamp Aortique	IV-19
<b>Ollier</b>	Rugine	VI-4
Oreillette	Ecarteur à Main	III-44
	<b>Harken (Clamp)</b>	IV-6
<b>O'Shaughnessy</b>	Dissecteur	IV-71
<b>P</b>		
Papillaires (Muscles)	<b>Carpentier (Ciseaux)</b>	II-28
	<b>Carpentier (Clamp)</b>	IV-5
<b>Paris</b>	Porte-Aiguilles à Anneaux	V-20
<b>Parry</b>	Clamp pour Artère Fémoro-Poplitée	IV-48
Passe-Fils (Clamps)		IV-65 à 69
	<b>Beck</b>	IV-68

## Index Alphabétique

	<b>Cooley</b>	IV-69
	<b>DeBakey</b>	IV-65, 66
	<b>Semb</b>	IV-67
Passe-Fils (Stylets)		VII-3
Passe-Lacs		VII-3
<b>Pean</b>	Clamp Vasculaire Périphérique	IV-35
Pédiatriques	Clamps	IV-89 à 100
	Ecarteurs	III-6, 21, 24, 26 à 28
Pincés à Dissection		I-10 à 24
	<b>Adlerkreutz</b>	I-21
	<b>Adson</b>	I-23
	<b>Barraya</b>	I-21
	<b>Carpentier</b>	I-10, 11
	<b>DeBakey</b>	I-12, 13
	<b>Durand</b>	I-21
	<b>Gerald</b>	I-14
	Micro	I-3 à I-9
	Pince d'Horloger	I-24
	<b>Resano</b>	I-10, 11
Pincés à Dissection Délicates		I-14, 15
Pincés à Préhension		IV-106 à 108
	<b>Allis</b>	IV-108
	<b>Babcock</b>	IV-106
	<b>Duval</b>	IV-107
	<b>Judd Allis</b>	IV-108
Pincés à Torsader		V-32, 33
Pincés Coupantes (Os)		VI-15 à 20
	<b>Bohler</b>	VI-17
	<b>Liston</b>	VI-15, 16, 19, 20
	<b>Mac Indoe</b>	VI-17
	<b>Ruskin Liston</b>	VI-18
Pincés Coupe-Fils		V-34
Pincés Hémostatiques		IV-101 à 105
	<b>Bengolea</b>	IV-105
	<b>Christophe</b>	IV-102
	<b>Crile</b>	IV-102
	<b>Halstead</b>	IV-104
	<b>Kelly</b>	IV-101
	<b>Kocher</b>	IV-101
	<b>Leriche</b>	IV-103
Pincés pour Aiguilles		I-16, 17, 18, 19
	<b>Adson Brown</b>	I-18
	<b>Chitwood-DeBakey</b>	I-19
	<b>Cushing</b>	I-16
	<b>Mac Indoe</b>	I-16
	<b>Potts-Smith</b>	I-17
	<b>Wangensteen</b>	I-18
<b>Poole</b>	Canule d'Aspiration	VII-9
Porte-Instruments	<b>Lortat Jacob</b>	VII-19
Porte-Aiguilles 4 Articulations	<b>DeBakey</b>	V-21
	<b>Mayo Hegar</b>	V-21
	<b>Ryder</b>	V-21
Porte-Aiguilles à Anneaux		V-19 à 30
	<b>Carpentier</b>	V-22
	<b>Crile Wood</b>	V-29
	<b>DeBakey</b>	V-28
	<b>DeBakey Fin</b>	V-27
	<b>Hegar</b>	V-25
	<b>Mayo Hegar</b>	V-30
	<b>Micro Ryder</b>	V-24
	Micro Vasculaire	V-23
	<b>Paris</b>	V-20

## Index Alphabétique

	<b>Ryder</b>	V-26
Porte-Aiguilles Micro		V-3 à 18
	3 Articulations	V-18
	<b>Castroviejo</b>	V-17
	<b>Jacobson</b>	V-15 à 17
<b>Potts</b>	Clamp Vasculaire Périphérique	IV-37
<b>Potts-Smith</b>	Ciseaux Cardiovasculaires	II-18
	Pince pour Aiguilles	I-17
Poumon (Spatules)		III-38, 44 à 46
	<b>Chevret</b>	III-45
	<b>Davidson</b>	III-38
	<b>Deaver</b>	III-56
	<b>Harrington</b>	III-46
Pousse-Nœuds	<b>Vasculaire</b>	V-31
Préhension (Pincés)		IV-106 à 108
	<b>Allis</b>	IV-108
	<b>Babcock</b>	IV-106
	<b>Duval</b>	IV-107
	<b>Judd Allis</b>	IV-108
Presse Tube	<b>Murphy</b>	VII-18
<b>Price Thomas</b>	Clamp à Bronches	IV-51
Punch Aortique		VII-6
Purge Aortique		VII-17
<b>R</b>		
<b>Rankin</b>	Bulldog à Anneaux	IV-73
Rapprocheur de Côtes		III-32, 33
	<b>Bailey</b>	III-32
	<b>Gibbon</b>	III-33
	<b>Kruz</b>	III-33
	<b>Sellor</b>	III-32
<b>Redon</b>	Dissecteur	IV-72
Rénale (Artère)	Clamp	IV-32
<b>Resano</b>	Pince à Dissection	I-10, 11
<b>Reynolds</b>	Ciseaux	II-35
<b>Ross</b>	Ciseaux Cardiovasculaires	II-25
Rugines		VI-4, 5
	<b>Doyen</b>	VI-4
	<b>Maurer</b>	VI-5
	<b>Ollier</b>	VI-4
<b>Rumel</b>	Tire-Fils	VII-3
	Passe-Lacs	VII-3
<b>Ruskin Liston</b>	Pince Coupante	VI-18
<b>Ryder</b>	Porte-Aiguilles 4 Articulations	V-21
	Porte-Aiguilles à Anneaux	V-26
<b>S</b>		
<b>Santulli</b>	Bulldog	IV-80
<b>Satinsky</b>	Clamp pour Veine Cave	IV-25
<b>Saylor</b>	Dissecteur	IV-72
<b>Scheibe</b>	Clamp Intestinal	IV-56
<b>Schuhknecht</b>	Canule d'Aspiration	VII-16
<b>Scoville</b>	Ecarteur	III-35
<b>Sellor</b>	Rapprocheur de Côtes	III-32
<b>Semb</b>	Ecarteur à Main	III-44
	Passe-Fils	IV-67
<b>Sicart</b>	Pince Gouge	VI-10
<b>Simon</b>	Ecarteur à Main	III-54
<b>Smith-Petersen</b>	Pince Gouge	VI-11
Sous-Clavière (Clamp)	<b>Henly</b>	IV-29
Spatules Doubles	<b>Davis</b>	III-50
	<b>Natali</b>	III-50
	<b>Toennis</b>	III-50
Spatules à Poumon		III-38, 44 à 46

## Index Alphabétique

	<b>Chevret</b>	III-45
	<b>Davidson</b>	III-38
	<b>Deaver</b>	III-56
	<b>Harrington</b>	III-46
Sternaux (Ecarteurs)		III-3 à 13, 21 à 23, 26 à 31
<b>Stevens</b>	Ciseaux	II-30
<b>Stille</b>	Pince Gouge	VI-8
Streamline	Micro Ciseaux	II-4
	Micro Ciseaux Jacobson	II-10, 11
Supracœliaque (Clamp pour Aorte)	Cherry	IV-22
<b>T</b>		
Ténotomie	Micro Ciseaux Baïonnette	II-16
	Micro Ciseaux Vannas	II-3
Testeurs Coronariens	<b>DeBakey</b>	VII-5
	<b>Garrett</b>	VII-5
Tire-Fils		VII-3
<b>Toennis</b>	Spatule Double	III-50
<b>Toennis Adson</b>	Ciseaux	II-40
<b>Tuffier</b>	Ecarteur Intercostal	III-20
<b>V</b>		
Vaisseaux Profonds (Clamp)	<b>Gregory</b>	IV-49
<b>Vannas</b>	Micro Ciseaux Baïonnette Ténatomie	II-16
	Micro Ciseaux Ténatomie	II-3
Vasculaire	Pousse-Nœuds	V-31
Vasculaire Périphérique (Clamps)		IV-33 à 49
	<b>Bainbridge</b>	IV-34
	<b>Cooley</b>	IV-40, 41, 47
	<b>Dale</b>	IV-44
	<b>DeBakey</b>	IV-33, 38 et 39
	<b>Derra</b>	IV-45, 46
	<b>Glover</b>	IV-42
	<b>Leland Jones</b>	IV-36
	<b>Pean</b>	IV-35
	<b>Potts</b>	IV-37
	<b>Wylie</b>	IV-43
Veine Cave (Clamps)		IV-25 à 27
	<b>Cooley</b>	IV-26, 27
	<b>Satinsky</b>	IV-25
<b>Vincent</b>	Pince Gouge	VI-10
<b>W</b>		
<b>Wagner</b>	Ciseaux	II-34
<b>Wangensteen</b>	Pince pour Aiguilles	I-18
<b>Weber</b>	Clamp Aortique	IV-12
<b>Weitlaner</b>	Ecarteur	III-41
<b>Wylie</b>	Clamp pour Aorte Abdominale	IV-21
	Clamp Vasculaire Périphérique	IV-43
<b>Y</b>		
<b>Yankauer</b>	Canule d'Aspiration	VII-10
<b>Z</b>		
<b>Zangler</b>	Clamp pour Aorte Abdominale	IV-20

# Heart Surgery Sets Kits de Chirurgie Cardiaque

Coronary Artery Bypass Set / Kit pour Pontages Coronariens	
Basic Set / Kit Essentiel.....	p. 3
Additional Set / Complément.....	p. 5
Heart Valves Surgery Set / Kit pour Chirurgie des Valves Cardiaques	
Basic Set / Kit Essentiel.....	p. 6
Additional Set / Complément.....	p. 7
Microsurgery Set / Kit pour Microchirurgie	
Basic Set / Kit Essentiel.....	p. 8
Additional Set / Complément.....	p. 9
Pediatric Set / Kit Pédiatrique	
Basic Set / Kit Essentiel.....	p. 10
Additional Set / Complément.....	p. 11



# Coronary Artery Bypass Set / Kit pour Pontages Coronariens

Basic Set / Kit Essentiel

## MICRO DISSECTING FORCEPS / MICRO PINCES À DISSECTION



**DC12310-18**

L: 180 mm - 7" - 180 g - Diamonite  
Round Handle / Manche Rond : ø 8 mm  
With Platform / Avec Plateforme : 0.4 x 6 mm

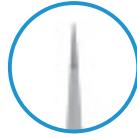

**DC12710-21**

L: 205 mm - 8" - 180 g - Diamonite  
Counterbalanced / Contrebalancée  
Round Handle / Manche Rond : ø 8 mm  
With Platform / Avec Plateforme : 0.4 x 6 mm

## DISSECTING FORCEPS / PINCES À DISSECTION



**DC15100-21**

**Potts Smith**  
L: 210 mm - 8"  
Tungsten Jaws / Mors Tungstène : 1.8 mm



**DC13010-23**

**Carpentier**  
L: 230 mm - 9 1/2" - 300 g  
Resano Jaws / Mors Resano



**DC13200-24**

**DeBakey**  
L: 240 mm - 9 1/2" - 200 g  
Jaws / Mors : 2 mm

## MICRO SCISSORS / MICRO CISEAUX



**DC20060-18**

**Jacobson**  
L: 180 mm - 7" - 25°  
Round Handle / Manche Rond  
Blades / Lames : 10 mm



**DC20061-18**

**Jacobson**  
L: 180 mm - 7" - 45°  
Round Handle / Manche Rond  
Blades / Lames : 10 mm



**DC20063-18**

**Jacobson**  
L: 180 mm - 7" - 90°  
Round Handle / Manche Rond  
Blades / Lames : 10 mm



**DC20064-18**

**Jacobson**  
L: 180 mm - 7" - 125°  
Round Handle / Manche Rond  
Blades / Lames : 10 mm



**DC20141-18**

**Streamline**  
L: 180 mm - 7"  
Curved / Courbe - Round Handle / Manche Rond  
Blades / Lames : 10 mm



## RING HANDLE SCISSORS / CISEAUX À ANNEAUX



**B86370**

**Reynolds**  
L: 150 mm - 6"  
Supercut / Microdentés  
Straight / Droit

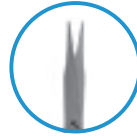

**B86375**

**Reynolds**  
L: 150 mm - 6"  
Supercut / Microdentés  
Curved / Courbe



**B86385**

**Jameson**  
L: 180 mm - 7"  
Supercut / Microdentés  
Curved / Courbe

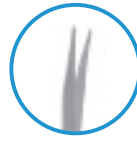

**DC21151-19**

**Potts Smith**  
L: 190 mm - 7 1/2"  
Angle : 45°



**DC21212-19**

**Hegemann**  
L: 190 mm - 7 1/2"  
Angle : 45°



**DC21214-19**

**Hegemann**  
L: 190 mm - 7 1/2"  
Angle : 90°



**DC21215-19**

**Hegemann**  
L: 190 mm - 7 1/2"  
Angle : 125°



## RETRACTOR / ÉCARTEUR



**DC30700-00**

**Bypass+**  
L: 170 mm - 9"  
Max Opening / Ouverture Max : 230 mm



## HOOK AND SPATULA / CROCHET ET SPATULE



**DC33100-00**

**Carpentier Hook / Crochet Carpentier**  
L: 240 mm - 9 1/2"  
Angle : 90°



**DC34100-00**

**Natali Spatula / Spatule Natali**  
L: 200 mm - 7 1/2"

# Coronary Artery Bypass Set / Kit pour Pontages Coronariens

Basic Set / Kit Essentiel

## CLAMPS / CLAMPS



**B86505**  
**Halstead Forceps**  
 L : 120 mm - 5"  
 Straight / Droite  
 Without Teeth / Sans Griffes



**B86515**  
**Halstead Forceps**  
 L : 120 mm - 5"  
 Straight / Droite  
 Without Teeth / Sans Griffes



**DC40080-26**  
**DeBakey**  
 L : 265 mm - 10 1/2"  
 Curved Jaws / Mors Courbes

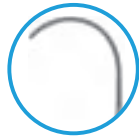

**DC40263-26**  
**DeBakey Satinsky**  
 Vena Cava - L : 265 mm - 10 1/2"  
 Curved Shanks / Branches Courbes  
 Double Angled Jaws / Mors Double Courbure



**B60535**  
**Redon**  
 L : 140 mm - 5 1/2"



**DC41009-57**  
**Johns Hopkins Bulldog**  
 L : 57 mm  
 Curved / Courbe



## MICRO NEEDLE HOLDERS / MICRO PORTE-AIGUILLES



**DC50002-21**  
**Jacobson**  
 L : 205 mm - 8" - Diamonite  
 Straight / Droit - Width / Largeur : 0.3 mm  
 Round Handle / Manche Rond - Ratchet / Crémaillère



**DC50442-21**  
**Jacobson**  
 L : 205 mm - 8" - Tungsten / Tungstène  
 Straight / Droit - Width / Largeur : 1.2 mm  
 Round Handle / Manche Rond - Ratchet / Crémaillère



**DC50610-23**  
**Jacobson**  
 L : 230 mm - 9 1/2" - Diamonite  
 Straight / Droit  
 Round Handle / Manche Rond - Ratchet / Crémaillère

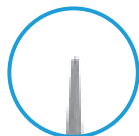

## RING HANDLE NEEDLE HOLDERS / PORTE-AIGUILLES À ANNEAUX



**DC51100-23**  
 L : 230 mm - 9 1/2"

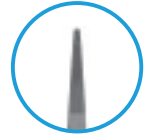

**DC51110-20**  
**Micro Ryder**  
 L : 200 mm - 7 7/8"

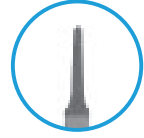

**DC51150-20**  
**DeBakey**  
 L : 200 mm - 7 7/8"



**DC51170-24**  
**Mayo Hegar**  
 L : 240 mm - 9 1/2"



## SPECIAL INSTRUMENTS / INSTRUMENTS SPÉCIAUX



**DC70400-15**  
**Heparine Needle / Aiguille Héparine**  
 ø : 1.5 mm  
 Set 3 Units / Lot de 3 pièces



**DC70400-25**  
**Heparine Needle / Aiguille Héparine**  
 ø : 2.5 mm  
 Set 3 Units / Lot de 3 pièces



**DC71420-15**  
**Garrett Dilator / Dilateurs Garrett**  
 ø : 1.5 mm - L : 140 mm - 5 1/2"

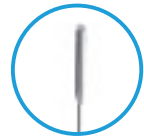

**DC71420-20**  
**Garrett Dilator / Dilateurs Garrett**  
 ø : 2.0 mm - L : 140 mm - 5 1/2"



**DC70800-26**  
**Stylet**  
 L : 260 mm - 10"  
 With Ring / Avec Anneau  
 Without Teeth / Sans Griffes



**J758300**  
**Wire Cutting Pliers / Pince Coupante**  
 L : 220 mm - 9" - 4 Articulations - ø Max 2.5 mm  
 Tungsten Jaws / Mors Tungstène





# Coronary Artery Bypass Set / Kit pour Pontages Coronariens

Additional Set / Complément

## MICRO DISSECTING FORCEPS / MICRO PINCES À DISSECTION



**DC12000-21**

**DeBakey**  
L: 210 mm - 8" - 180 g - Jaws / Mors: 1.3 mm  
Straight / Droite  
Round Handle / Manche Rond: ø 8 mm

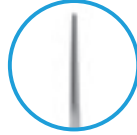

**DC12900-21**

L: 210 mm - 8" - 180 g - Diamonite  
Ring Tip / Bout Anneau: 1 mm  
Round Handle / Manche Rond: ø 8 mm

## DISSECTING FORCEPS / PINCES À DISSECTION



**DC15400-20**

**Chitwood DeBakey**  
L: 200 mm - 7 1/2" - 200 g  
Jaws / Mors: 1.5 mm  
Tungsten / Tungstène



**DC20061-21**

**Jacobson**  
L: 210 mm - 8" - 45°  
Round Handle / Manche Rond  
Blades / Lames: 10 mm



**DC20063-21**

**Jacobson**  
L: 210 mm - 8" - 95°  
Round Handle / Manche Rond  
Blades / Lames: 10 mm



**DC20064-21**

**Jacobson**  
L: 210 mm - 8" - 125°  
Round Handle / Manche Rond  
Blades / Lames: 10 mm



**DC20121-18**

L: 180 mm - 7" - 45°  
Ball Type / Embout Sphérique: 1.5 mm  
Round Handle / Manche Rond  
Blades / Lames: 10 mm



**DC20123-18**

L: 180 mm - 7" - 90°  
Ball Type / Embout Sphérique: 1.5 mm  
Round Handle / Manche Rond  
Blades / Lames: 10 mm



**DC20124-18**

L: 180 mm - 7" - 125°  
Ball Type / Embout Sphérique: 1.5 mm  
Round Handle / Manche Rond - Blades / Lames: 10 mm



## EPICARDIAL RETRACTOR / ÉCARTEUR ÉPICARDIAL

**DC32450-28**

L: 35 mm  
3X3 Hooks / Griffes

## CLAMPS / CLAMPS



**DC40411-20**

**Kay Lambert**  
L: 200 mm - 7 1/2"  
Angled Shanks / Branches Coudées  
"U" Turn Jaws / Mors Demi Tour



**DC43710-18**

**Gemini**  
L: 180 mm - 7"  
Fine / Fin  
1/2 Curved / 1/2 Courbe



**DC43711-18**

**Gemini**  
L: 180 mm - 7"  
Very Fine / Très Fin  
1/2 Curved / 1/2 Courbe



**DC41230-48**

**Dietrich Bulldog**  
L: 48 mm - 80 g  
Jaws / Mors: 0.8 mm  
Angled / Coudée



**DC41230-50**

**Dietrich Bulldog**  
L: 50 mm - 80 g  
Jaws / Mors: 1.2 mm  
Angled / Coudée



**DC41230-52**

**Dietrich Bulldog**  
L: 55 mm - 80 g  
Jaws / Mors: 2.0 mm  
Angled / Coudée



**DC50202-21**

**Jacobson**  
L: 205 mm - 8" - Diamonite  
Straight / Droit - Width / Largeur: 0.8 mm  
Round Handle / Manche Rond - Ratchet / Crémaillère



**DC51180-18**

**Forceps for Cerclage Thread**  
Pince à Torsader les Fils  
L: 180 mm - 7"



## SPECIAL INSTRUMENTS / INSTRUMENTS SPÉCIAUX

**DC72300-04**

**Aortic Punch / Punch Aortique**  
ø: 4.0 mm

# Heart Valves Surgery Set / Kit pour Chirurgie des Valves Cardiaques

Basic Set / Kit Essentiel

## DISSECTING FORCEPS / PINCES À DISSECTION



**DC13010-23**

**Carpentier**  
L: 230 mm - 9 1/2" - 300 g  
Resano Jaws / Mors Resano

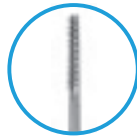

**DC13010-32**

**Carpentier**  
L: 320 mm - 13" - 300 g  
Resano Jaws / Mors Resano



**DC13110-28**

**Carpentier**  
L: 280 mm - 11" - 300 g  
3 Articulations  
Resano Jaws / Mors Resano



**DC13200-24**

**DeBakey**  
L: 240 mm - 9 1/2" - 200 g  
Jaws / Mors: 2 mm

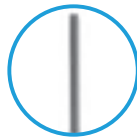

**DC13200-30**

**DeBakey**  
L: 300 mm - 12" - 200 g  
Jaws / Mors: 2 mm

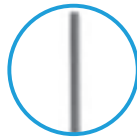

**B35100**

**Metzenbaun Fino**  
L: 230 mm - 9"  
Curved / Courbe  
Tungsten / Tungstène



**DC33100-00**

**Carpentier**  
L: 240 mm - 9 1/2"  
Angle: 90°



**DC33110-01**

**Carpentier**  
L: 240 mm - 9 1/2"  
Angle: 125°  
Extended / Allongé



**DC33120-00**

**Carpentier**  
L: 240 mm - 9 1/2"  
Angle: 45°



**DC51000-23**

**Carpentier**  
L: 230 mm - 9"



**DC51011-27**

**Carpentier**  
L: 270 mm - 10 1/2"  
4 Articulations



**DC51150-23**

**DeBakey**  
L: 230 mm - 9"



**DC51170-24**

**Mayo Hegar**  
L: 240 mm - 9 1/2"



**DC51180-18**

**Forceps for Cerclage Threads**  
Pince à Torsader les Fils  
L: 180 mm - 7"



**DC71500-00**

**Aortic Suction Needle**  
Aiguille pour Suction Aortique



## RING HANDLE SCISSORS / CISEAUX À ANNEAUX



**DC30000-00**

**Carpentier**  
L: 175 mm - 7"  
Max Opening / Ouverture Max: 280 mm - 11"



**DC33000-14**

**Carpentier**  
L: 240 mm - 9 1/2"  
Width / Largeur: 14 mm



**DC33000-17**

**Carpentier**  
L: 240 mm - 9 1/2"  
Width / Largeur: 17 mm



**DC33000-20**

**Carpentier**  
L: 240 mm - 9 1/2"  
Width / Largeur: 20 mm



## NEEDLE HOLDERS / PORTE-AIGUILLES



# Heart Valves Surgery Set / Kit pour Chirurgie des Valves Cardiaques

Additional Set / Complément

## MICRO DISSECTING FORCEPS / MICRO PINCES À DISSECTION



**DC12500-21**

**DeBakey**  
L: 210 mm - 8" - 180 g - Jaws / Mors: 1.3 mm  
Straight / Droite - Round Handle / Manche Rond: ø 8 mm  
Counterbalanced / Contrebalancée

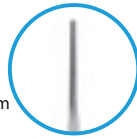

## DISSECTING FORCEPS / PINCES À DISSECTION



**B86785**

**Durand Prestige**  
L: 200 mm - 7 1/2"  
Russian Model / Patte de Velours



**DC13100-24**

**DeBakey**  
L: 240 mm - 9 1/2" - 200 g  
Jaws / Mors: 1.5 mm

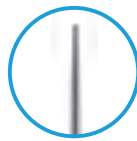

## RING HANDLE SCISSORS / CISEAUX À ANNEAUX



**B351751**

**Metzenbaum**  
L: 250 mm - 10"  
Curved / Courbe  
Tungsten / Tungstène

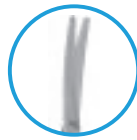

**DC21050-26**

**Carpentier**  
L: 260 mm - 10 1/2"  
4 Articulations



**DC21212-19**

**Hegemann**  
L: 190 mm - 7 1/2"  
Angle: 45°



## RETRACTORS / ÉCARTEURS



**DC36800-06**

**Cooley**  
L: 215 mm - 8 1/2"  
Width / Largeur: 40 mm - Depth / Profondeur: 35 mm  
Right / Droite



**DC36800-12**

**Cooley**  
L: 250 mm - 10"  
Width / Largeur: 50 mm - Depth / Profondeur: 10 mm  
Left / Gauche



## CLAMPS / CLAMPS



**DC40100-12**

**DeBakey**  
L: 120 mm - 5"  
Straight / Droit

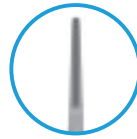

**DC45000-25**

**Carpentier**  
L: 250 mm - 10"  
Resano Jaws / Mors Resano

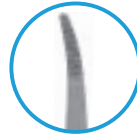

**DC45001-25**

**Carpentier**  
L: 250 mm - 10"  
Resano Jaws / Mors Resano  
Strongly Angled / Très Coudés

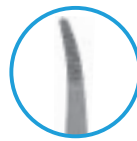

**DC45000-29**

**Carpentier**  
L: 290 mm - 11 2/5"  
Resano Jaws / Mors Resano

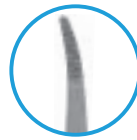

## RING HANDLE NEEDLE HOLDERS / PORTE-AIGUILLES À ANNEAUX



**DC51110-23**

**Micro Ryder**  
L: 230 mm - 9 1/2"

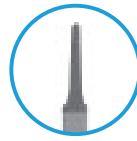

**DC51130-20**

**Ryder**  
L: 200 mm - 8"

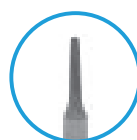

**DC51170-16**

**Mayo Hegar**  
L: 160 mm - 6 1/4"



**DC51170-20**

**Mayo Hegar**  
L: 200 mm - 8"



## SPECIAL INSTRUMENTS / INSTRUMENTS SPÉCIAUX



**DC81400-00**

**Obadia Suture Ring / Anneau à Suture Obadia**  
ø 220 mm



# Microsurgery Set / Kit pour Microchirurgie

## Basic Set / Kit Essentiel

### MICRO DISSECTING FORCEPS / MICRO PINCE À DISSECTION



**DC12000-18**

**DeBakey**  
L: 180 mm - 7" - 180 g - Jaws / Mors : 1.3 mm  
Straight / Droite  
Round Handle / Manche Rond : ø 8 mm



**DC12000-21**

**DeBakey**  
L: 210 mm - 8" - 180 g - Jaws / Mors : 1.3 mm  
Straight / Droite  
Round Handle / Manche Rond : ø 8 mm



**DC12310-18**

L: 180 mm - 7" - 180 g - Diamonite  
Round Handle / Manche Rond : ø 8 mm  
With Platform / Avec Plateforme : 0.4 x 6 mm



**DC12310-21**

L: 210 mm - 8" - 180 g - Diamonite  
Round Handle / Manche Rond : ø 8 mm  
With Platform / Avec Plateforme : 0.4 x 6 mm



**DC12710-21**

L: 205 mm - 8" - 180 g - Diamonite  
Counterbalanced / Contrebalancée  
Round Handle / Manche Rond : ø 8 mm  
With Platform / Avec Plateforme : 0.4 x 6 mm



**DC12920-18**

L: 180 mm - 7" - 180 g - Diamonite  
Ring Tip / Bout Anneau : 1 mm  
Round Handle / Manche Rond : ø 8 mm  
Counterbalanced / Contrebalancée



**DC12920-21**

L: 205 mm - 8" - 180 g - Diamonite  
Ring Tip / Bout Anneau : 1 mm  
Round Handle / Manche Rond : ø 8 mm  
Counterbalanced / Contrebalancée



**DC20064-18**

**Jacobson**  
L: 180 mm - 7" - 125°  
Round Handle / Manche Rond  
Blades / Lames : 10 mm



**DC20143-18**

**Streamline**  
L: 180 mm - 7" - 45°  
Round Handle / Manche Rond  
Blades / Lames : 10 mm



**DC20146-18**

**Streamline**  
L: 180 mm - 7" - 125°  
Round Handle / Manche Rond  
Blades / Lames : 10 mm



**DC50102-21**

**Jacobson**  
L: 205 mm - 8" - Diamonite  
Straight / Droit - Width / Largeur : 0.5 mm  
Round Handle / Manche Rond - Ratchet / Crémaillère



**DC50201-18**

**Jacobson**  
L: 180 mm - 7" - Diamonite  
Straight / Droit - Width / Largeur : 0.8 mm  
Round Handle / Manche Rond - Ratchet / Crémaillère



**DC50202-21**

**Jacobson**  
L: 205 mm - 8" - Diamonite  
Straight / Droit - Width / Largeur : 0.8 mm  
Round Handle / Manche Rond - Ratchet / Crémaillère



**DC50302-21**

**Jacobson**  
L: 215 mm - 8" - Tungsten / Tungstène  
Straight / Droit - Width / Largeur : 1.0 mm  
Flat Handle / Manche Plat - Ratchet / Crémaillère



**DC50342-21**

**Jacobson**  
L: 210 mm - 8" - Tungsten / Tungstène  
Straight / Droit - Width / Largeur : 1.0 mm  
Round Handle / Manche Rond - Ratchet / Crémaillère

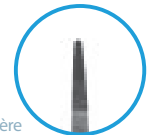

**DC50442-21**

**Jacobson**  
L: 205 mm - 8" - Tungsten / Tungstène  
Straight / Droit - Width / Largeur : 1.2 mm  
Round Handle / Manche Rond - Ratchet / Crémaillère

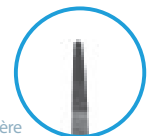

**DC50542-21**

**Jacobson**  
L: 205 mm - 8" - Tungsten / Tungstène  
Straight / Droit - Width / Largeur : 1.5 mm  
Round Handle / Manche Rond - Ratchet / Crémaillère



**DC20061-18**

**Jacobson**  
L: 180 mm - 7" - 45°  
Round Handle / Manche Rond  
Blades / Lames : 10 mm



**DC20062-18**

**Jacobson**  
L: 180 mm - 7" - 60°  
Round Handle / Manche Rond  
Blades / Lames : 10 mm



**DC20063-18**

**Jacobson**  
L: 180 mm - 7" - 90°  
Round Handle / Manche Rond  
Blades / Lames : 10 mm



### MICRO SCISSORS / MICRO CISEAUX



# Microsurgery Set / Kit pour Microchirurgie

Additional Set / Complément

## MICRO DISSECTING FORCEPS / MICRO PINCES À DISSECTION



**DC12100-18**

**DeBakey**  
L: 180 mm - 7" - 180 g - Jaws / Mors: 0.4 mm  
Straight / Droite  
Round Handle / Manche Rond : ø 8 mm

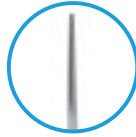

**DC12500-21**

**DeBakey**  
L: 210 mm - 8" - 180 g - Jaws / Mors: 1.3 mm  
Straight / Droite - Round Handle / Manche Rond : ø 8 mm  
Counterbalanced / Contrebalancée

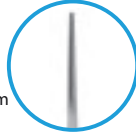

**DC12900-21**

L: 210 mm - 8" - 180 g - Diamonite  
Ring Tip / Bout Anneau : 1 mm  
Round Handle / Manche Rond : ø 8 mm



**DC50341-18**

**Jacobson**  
L: 180 mm - 7" - Tungsten / Tungstène  
Straight / Droit - Width / Largeur: 1.0 mm  
Round Handle / Manche Rond - Ratchet / Crémaillère



**DC50501-18**

**Jacobson**  
L: 180 mm - 7" - Tungsten / Tungstène  
Straight / Droit - Width / Largeur: 1.5 mm  
Flat Handle / Manche Plat - Ratchet / Crémaillère



**DC50543-23**

**Jacobson**  
L: 225 mm - 9" - Tungsten / Tungstène  
Straight / Droit - Width / Largeur: 1.5 mm  
Round Handle / Manche Rond - Ratchet / Crémaillère



**DC50634-23**

**Jacobson**  
L: 230 mm - 9" - Diamonite  
Straight / Droit - Heavy Style / Modèle Épais  
Round Handle / Manche Rond - Ratchet / Crémaillère



**DC20141-18**

**Streamline**  
L: 180 mm - 7"  
Curved / Courbe - Round Handle / Manche Rond  
Blades / Lames: 10 mm

## MICRO SCISSORS / MICRO CISEAUX



## MICRO NEEDLE HOLDERS / MICRO PORTE-AIGUILLES



**DC50001-18**

**Jacobson**  
L: 180 mm - 7" - Diamonite  
Straight / Droit - Width / Largeur: 0.3 mm  
Round Handle / Manche Rond - Ratchet / Crémaillère



**DC50101-18TI**

**Jacobson**  
L: 180 mm - 7" - Diamonite - Titanium / Titane  
Straight / Droit - Width / Largeur: 0.5 mm  
Round Handle / Manche Rond - Ratchet / Crémaillère



**DC50002-21**

**Jacobson**  
L: 205 mm - 8" - Diamonite  
Straight / Droit - Width / Largeur: 0.3 mm  
Round Handle / Manche Rond - Ratchet / Crémaillère



**DC50102-21TI**

**Jacobson**  
L: 205 mm - 8" - Diamonite - Titanium / Titane  
Straight / Droit - Width / Largeur: 0.5 mm  
Round Handle / Manche Rond - Ratchet / Crémaillère



**DC50021-18**

**Jacobson**  
L: 180 mm - 7" - Diamonite  
Straight / Droit - Width / Largeur: 0.3 mm  
Round Handle / Manche Rond



**DC50103-23**

**Jacobson**  
L: 225 mm - 9" - Diamonite  
Straight / Droit - Width / Largeur: 0.5 mm  
Round Handle / Manche Rond - Ratchet / Crémaillère



# Pediatric Set / Kit Pédiatrique

## Basic Set / Kit Essentiel

### MICRO DISSECTING FORCEPS / MICRO PINCES À DISSECTION



**DC12000-18**

**DeBakey**  
L: 180 mm - 7" - 180 g - Jaws / Mors : 1.3 mm  
Straight / Droite  
Round Handle / Manche Rond : ø 8 mm



**DC12310-18**

L: 180 mm - 7" - 180 g - Diamonite  
Round Handle / Manche Rond : ø 8 mm  
With Platform / Avec Plateforme : 0.4 x 6 mm



**DC12920-18**

L: 180 mm - 7" - 180 g - Diamonite  
Ring Tip / Bout Anneau : 1 mm  
Round Handle / Manche Rond : ø 8 mm  
Counterbalanced / Contrebalancée

### MICRO SCISSORS / MICRO CISEAUX



**DC20055-18**

**Jacobson**  
L: 180 mm - 7" - 25°  
Round Handle / Manche Rond  
Blades / Lames : 7 mm



**DC20056-18**

**Jacobson**  
L: 180 mm - 7" - 45°  
Round Handle / Manche Rond  
Blades / Lames : 7 mm



**DC20059-18**

**Jacobson**  
L: 180 mm - 7" - 125°  
Round Handle / Manche Rond  
Blades / Lames : 7 mm

### RETRACTORS / ÉCARTEURS



**DC31300-01**

**Finochietto Neonatal / Nouveau-Né**  
Length / Longueur : 25 mm - Width / Largeur : 7 mm  
Depth / Profondeur : 6 mm  
Max. Opening / Ouverture Max. : 36 mm



**DC31300-02**

**Finochietto Infant / Nourisson**  
Length / Longueur : 55 mm - Width / Largeur : 14 mm  
Depth / Profondeur : 12 mm  
Max. Opening / Ouverture Max. : 80 mm



**DC31300-03**

**Finochietto Child / Enfant**  
Length / Longueur : 75 mm - Width / Largeur : 32 mm  
Depth / Profondeur : 30 mm  
Max. Opening / Ouverture Max. : 100 mm



**DC31650-00**

**Cooley Child / Enfant**  
Length / Longueur : 100 mm - Width / Largeur : 45 mm  
Depth / Profondeur : 24 mm  
Max. Opening / Ouverture Max. : 155 mm



**DC31656-00**

**Cooley**  
Length / Longueur : 80 mm - Width / Largeur : 30 mm  
Depth / Profondeur : 15 mm  
Max. Opening / Ouverture Max. : 105 mm



### CLAMPS / CLAMPS

**DC42024-00**

**Castaneda DeBakey**  
L: 120 mm - 4<sup>4/5</sup>" - Jaws / Mors : 1.4 mm  
Curved Shanks / Branches Courbes



**DC42031-00**

**Castaneda DeBakey**  
L: 125 mm - 4<sup>4/5</sup>"  
Jaws / Mors : 1.4 mm  
Curved Shanks 1/2 Moon / Branches Courbes 1/2 Lune



**DC42106-15**

**Castaneda**  
L: 155 mm - 6"



**DC42107-15**

**Castaneda**  
L: 155 mm - 6"



### MICRO NEEDLE HOLDERS / MICRO PORTE-AIGUILLES

**DC50001-18**

**Jacobson**  
L: 180 mm - 7" - Diamonite  
Straight / Droit - Width / Largeur : 0.3 mm  
Round Handle / Manche Rond - Ratchet / Crémaillère



**DC50002-21**

**Jacobson**  
L: 205 mm - 8" - Diamonite  
Straight / Droit - Width / Largeur : 0.3 mm  
Round Handle / Manche Rond - Ratchet / Crémaillère

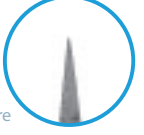

**DC50021-18**

**Jacobson**  
L: 180 mm - 7" - Diamonite  
Straight / Droit - Width / Largeur : 0.3 mm  
Round Handle / Manche Rond



# Pediatric Set / Kit Pédiatrique

Additional Set / Complément

## MICRO DISSECTING FORCEPS / MICRO PINCES À DISSECTION



**DC12000-21**

**DeBakey**  
L: 210 mm - 8" - 180 g - Jaws / Mors: 1.3 mm  
Straight / Droite  
Round Handle / Manche Rond: ø 8 mm

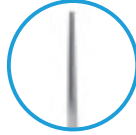

**DC12310-15**

L: 150 mm - 6" - 180 g - Diamonite  
Round Handle / Manche Rond: ø 8 mm  
With Platform / Avec Plateforme: 0.4 x 6 mm



**DC12920-15**

L: 150 mm - 6" - 180 g - Diamonite  
Ring Tip / Bout Anneau: 1 mm  
Round Handle / Manche Rond: ø 8 mm  
Counterbalanced / Contrebalancée

## MICRO SCISSORS / MICRO CISEAUX



**DC20057-18**

**Jacobson**  
L: 180 mm - 7" - 60°  
Round Handle / Manche Rond  
Blades / Lames: 7 mm



**DC20058-18**

**Jacobson**  
L: 180 mm - 7" - 90°  
Round Handle / Manche Rond  
Blades / Lames: 7 mm

## RETRACTORS / ÉCARTEURS



**DC31100-20**

**Morse Favaloro Child / Enfant**  
Length / Longueur: 120 mm - Width / Largeur: 20 mm  
Depth / Profondeur: 12 mm  
Max. Opening / Ouverture Max.: 155 mm



**DC31200-01**

**Morse Favaloro Child / Enfant**  
Length / Longueur: 120 mm - Width / Largeur: 20 mm  
Depth / Profondeur: 20 mm  
Max. Opening / Ouverture Max.: 155 mm

## CLAMPS / CLAMPS



**DC42049-00**

**Castaneda DeBakey**  
L: 110 mm - 4<sup>2/5</sup>" - Jaws / Mors: 1.4 mm  
Angled Shank / Branches Coudées  
Curved Shank 1/2 Moon / Branches Courbes 1/2 Lune



**DC42055-30**

**Castaneda DeBakey**  
L: 125 mm - 5"  
Jaws / Mors: 1.4 mm  
Strongly Angled 30° / Branches très Coudées 30°



**DC42103-12**

**Castaneda**  
L: 120 mm - 4<sup>4/5</sup>"  
Jaws / Mors: DeBakey  
1 x 2 Teeth / Dents



**DC42108-12**

**Castaneda**  
L: 120 mm - 4<sup>4/5</sup>"  
Jaws / Mors: DeBakey  
1 x 2 Teeth / Dents



**DC42202-13**

L: 130 mm - 6"  
Streaked and Graduated Jaws  
Mors Gradués et Striés



**DC42203-12**

L: 125 mm - 6"  
Streaked and Graduated Jaws  
Mors Gradués et Striés



**DC42207-15**

L: 150 mm - 6"  
Streaked and Graduated Jaws  
Mors Gradués et Striés

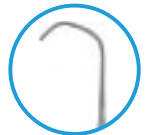





# Dissecting Forceps Pinces à Dissection

## Micro Dissecting Forceps - *Micro Pinces à Dissection*

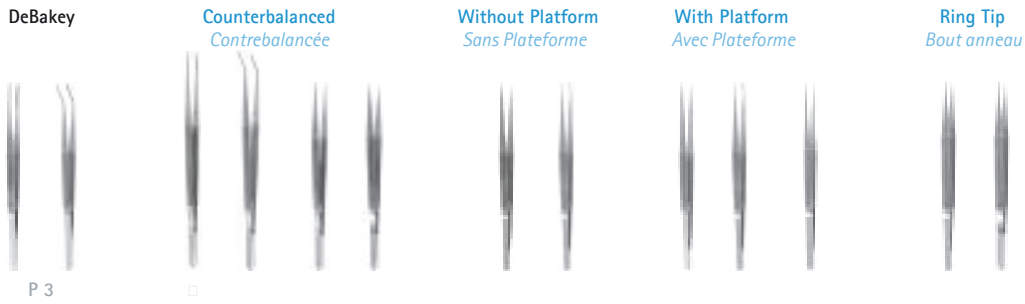

## Atraumatic Dissecting Forceps - *Pinces à Dissection Atraumatiques*

## Delicate Tissue Forceps - *Pinces Délicates*



## Needle Pulling Forceps - *Pinces pour Aiguilles*

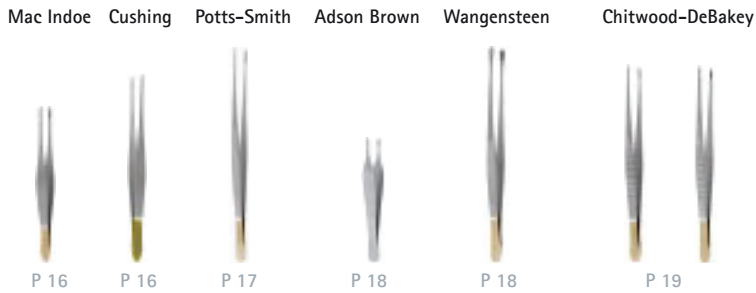

## Prestige Tissue Forceps - *Pinces Prestige*

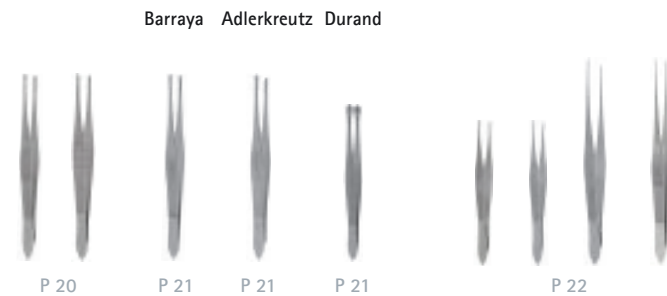



# Dissecting Forceps Pinces à Dissection

## Adson Tissue Forceps - *Pinces Adson*

Adson      Micro-Adson



P 23

## Jeweler Tissue Forceps - *Pinces d'Horloger*



P 24

# DeBakey Micro Tissue Forceps

## Micro Pincers DeBakey



Round Handle - Jaws 1.3 mm  
Manche Rond - Mors 1,3 mm





Straight, Ø 8 mm Handle  
Droite, Manche Ø 8 mm  
Pressure 180 gr  
Pression 180 g

**DC12000-12**  
L : 120 mm - 4 3/4 "

**DC12000-15**   
L : 150 mm - 6 "

**DC12000-18**   
L : 180 mm - 7 "

**DC12000-21**   
L : 210 mm - 8 "

**DC12000-23**   
L : 230 mm - 9 "

Straight, Ø 10 mm Handle  
Droite, Manche Ø 10 mm  
Pressure 250 gr  
Pression 250 g

**DC12010-18**   
L : 180 mm - 7 "

**DC12010-21**   
L : 210 mm - 8 "



Angled, Ø 8 mm Handle  
Coudée, Manche Ø 8 mm  
Pressure 180 gr  
Pression 180 g

**DC12001-12**  
L : 120 mm - 4 3/4 "

**DC12001-15**   
L : 150 mm - 6 "

**DC12001-18**   
L : 180 mm - 7 "

**DC12001-21**   
L : 210 mm - 8 "

**DC12001-23**   
L : 230 mm - 9 "

# DeBakey Micro Tissue Forceps

## Micro Pincettes DeBakey

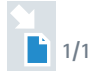

Round Handle - Jaws 1.3 mm - Counterbalanced  
 Manche Rond - Mors 1,3 mm - Contrebalancée



Straight, Ø 8 mm Handle  
 Droite, Manche Ø 8 mm  
 Pressure 180 gr  
 Pression 180 g

- DC12500-18  
L : 180 mm - 7 "
- DC12500-21  
L : 210 mm - 8 "



Angled, Ø 8 mm Handle  
 Coudée, Manche Ø 8 mm  
 Pressure 180 gr  
 Pression 180 g

- DC12501-18  
L : 180 mm - 7 "
- DC12501-21  
L : 210 mm - 8 "

# Tying Micro Tissue Forceps

## Micro Pincés à Dissection

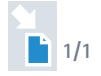



Round Handle - Without Platform  
Manche Rond - Sans Plateforme



Straight, Ø 8 mm Handle  
Droite, Manche Ø 8 mm  
Pressure 180 gr  
Pression 180 g

0.4 mm





- DC12100-12**  
L : 120 mm - 4 3/4 "
- DC12100-15**   
L : 150 mm - 6 "
- DC12100-18**   
L : 180 mm - 7 "
- DC12100-21**   
L : 210 mm - 8 "



Curved, Ø 8 mm Handle  
Courbe, Manche Ø 8 mm  
Pressure 180 gr  
Pression 180 g

0.4 mm



- DC12101-12**  
L : 120 mm - 4 3/4 "
- DC12101-15**   
L : 150 mm - 6 "
- DC12101-18**   
L : 180 mm - 7 "
- DC12101-21**   
L : 210 mm - 8 "

# Tying Micro Tissue Forceps

## Micro Pincettes à Dissection

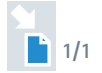

1/1



Diamonite

Round Handle - With Platform  
Manche Rond - Avec Plateforme

Straight, Ø 8 mm Handle  
Droite, Manche Ø 8 mm  
Pressure 180 gr  
Pression 180 g

0.4 x 6 mm



DC12310-12

L : 120 mm - 4 3/4 "

DC12310-15

L : 150 mm - 6 "

DC12310-18

L : 180 mm - 7 "

DC12310-21

L : 210 mm - 8 "

0.8 x 6 mm



DC12320-15

L : 150 mm - 6 "

DC12320-18

L : 180 mm - 7 "

DC12320-21

L : 210 mm - 8 "

Straight, Ø 10 mm Handle  
Droite, Manche Ø 10 mm  
Pressure 250 gr  
Pression 250 g

0.4 x 6 mm



DC12330-18

L : 180 mm - 7 "

DC12330-21

L : 210 mm - 8 "

0.8 x 6 mm



DC12340-18

L : 180 mm - 7 "

DC12340-21

L : 210 mm - 8 "

Curved, Ø 8 mm Handle  
Courbe, Manche Ø 8 mm  
Pressure 180 gr  
Pression 180 g

0.4 x 6 mm



DC12311-12

L : 120 mm - 4 3/4 "

DC12311-15

L : 150 mm - 6 "

DC12311-18

L : 180 mm - 7 "

DC12311-21

L : 210 mm - 8 "

0.8 x 6 mm



DC12321-15

L : 150 mm - 6 "

DC12321-18

L : 180 mm - 7 "

DC12321-21

L : 210 mm - 8 "

# Tying Micro Tissue Forceps

## Micro Pincés à Dissection

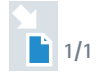

Round Handle - With Platform and Teeth  
Manche Rond - À Griffes avec Plateforme

Straight, Ø 8 mm Handle - Teeth : 1 x 2  
Droite, Manche Ø 8 mm - Griffes : 1 x 2

Pressure 180 gr  
Pression 180 g

0.5 x 6 mm



**DC12410-12**

L : 120 mm - 4 3/4 "

**DC12410-15**

L : 150 mm - 6 "

**DC12410-18**

L : 180 mm - 7 "

**DC12410-21**

L : 205 mm - 8 "

Curved, Ø 8 mm Handle - Teeth : 1 x 2  
Courbe, Manche Ø 8 mm - Griffes : 1 x 2

Pressure 180 gr  
Pression 180 g

0.5 x 6 mm



**DC12411-12**

L : 120 mm - 4 3/4 "

**DC12411-15**

L : 150 mm - 6 "

**DC12411-18**

L : 180 mm - 7 "

**DC12411-21**

L : 205 mm - 8 "



# Tying Micro Tissue Forceps

## Micro Pincers à Dissection

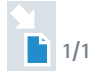

1/1



Diamondite



Counterbalanced

Round Handle - Counterbalanced  
Manche Rond - Contrebalancée

Straight, Ø 8 mm Handle  
Droite, Manche Ø 8 mm

Without Platform  
Sans Plateforme  
Pressure 180 gr  
Pression 180 g

0.4 mm



DC12600-15

L : 150 mm - 6 "

DC12600-18

L : 180 mm - 7 "

DC12600-21

L : 205 mm - 8 "

With Platform  
Avec Plateforme  
Pressure 180 gr  
Pression 180 g

0.4 x 6 mm

DC12710-15

L : 150 mm - 6 "

DC12710-18

L : 180 mm - 7 "

DC12710-21

L : 205 mm - 8 "

Teeth 1 x 2  
Griffes 1 x 2  
With Platform  
Avec Plateforme  
Pressure 180 gr  
Pression 180 g

0.5 x 6 mm

DC12810-15

L : 150 mm - 6 "

DC12810-18

L : 180 mm - 7 "

DC12810-21

L : 205 mm - 8 "

Curved, Ø 8 mm Handle  
Courbe, Manche Ø 8 mm

Without Platform  
Sans Plateforme  
Pressure 180 gr  
Pression 180 g

0.4 mm



DC12601-15

L : 150 mm - 6 "

DC12601-18

L : 180 mm - 7 "

DC12601-21

L : 205 mm - 8 "



# Micro Tissue Forceps

## Micro Pincés à Dissection

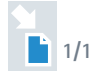

Round Handle - Ring Tip  
Manche Rond - Extrémité Anneau



Ø 8 mm Handle  
Manche Ø 8 mm  
Pressure 180 gr  
Pression 180 g

Ø 10 mm Handle  
Manche Ø 10 mm  
Pressure 250 gr  
Pression 250 g

Ø 8 mm Handle  
Manche Ø 8 mm  
Pressure 180 gr  
Pression 180 g

Ø 1 mm

Ø 1 mm

Ø 1 mm

**DC12900-12**

L : 120 mm - 4 <sup>3</sup>/<sub>4</sub> "

**DC12900-15**

L : 150 mm - 6 "

**DC12900-18**

L : 180 mm - 7 "

**DC12900-21**

L : 210 mm - 8 "

**DC12940-18**

L : 180 mm - 7 "

**DC12940-21**

L : 210 mm - 8 "

**DC12920-15**

L : 150 mm - 6 "

**DC12920-18**

L : 180 mm - 7 "

**DC12920-21**

L : 210 mm - 8 "

Ø 2 mm

Ø 2 mm

**DC12905-12**

L : 120 mm - 4 <sup>3</sup>/<sub>4</sub> "

**DC12905-15**

L : 150 mm - 6 "

**DC12905-18**

L : 180 mm - 7 "

**DC12905-21**

L : 210 mm - 8 "

**DC12925-15**

L : 150 mm - 6 "

**DC12925-18**

L : 180 mm - 7 "

**DC12925-21**

L : 210 mm - 8 "



# Carpentier Dissecting Atrauma Tissue Forceps

## Pincettes Carpentier Atraumatiques

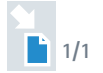

The "Magic Forceps" - Resano Jaws  
La "Pince Magique" - Mors Resano



Soft  
Souple  
Pressure 170 gr  
Pression 170 g



**DC13020-18**

L : 180 mm - 6 "

**DC13020-23**

L : 230 mm - 9 1/2 "

**DC13020-27**

L : 270 mm - 11 "

**DC13020-32**

L : 320 mm - 13 "



Strong  
Forte  
Pressure 300 gr  
Pression 300 g



**DC13010-18**

L : 180 mm - 6 "

**DC13010-23**

L : 230 mm - 9 1/2 "

**DC13010-27**

L : 270 mm - 11 "

**DC13010-32**

L : 320 mm - 13 "



# Carpentier Dissecting Atrauma Tissue Forceps

## Pince Carpentier Atraumatique



3 Articulations - Resano Jaws

3 Articulations - Mors Resano



DC13110-28 

L : 280 mm - 11 "

# DeBakey Atrauma Tissue Forceps

## Pincés DeBakey Atraumatiques

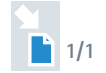

Straight - Pressure 200 gr  
Droite - Pression 200 g

Jaws 1 mm  
Mors 1 mm



- DC13101-12**  
L : 120 mm - 4 3/4 "
- DC13101-16**  
L : 160 mm - 6 "
- DC13101-20**   
L : 200 mm - 8 "
- DC13101-24**  
L : 240 mm - 9 1/2 "
- DC13101-30**  
L : 300 mm - 12 "

Jaws 1.5 mm  
Mors 1,5 mm



- DC13100-16**   
L : 160 mm - 6 "
- DC13100-20**   
L : 200 mm - 8 "
- DC13100-24**   
L : 240 mm - 9 1/2 "
- DC13100-30**  
L : 300 mm - 12 "

Jaws 2 mm  
Mors 2 mm



- DC13200-16**   
L : 160 mm - 6 "
- DC13200-20**   
L : 200 mm - 8 "
- DC13200-24**   
L : 240 mm - 9 1/2 "
- DC13200-30**  
L : 300 mm - 12 "

Jaws 2.8 mm  
Mors 2,8 mm



- DC13300-16**   
L : 160 mm - 6 "
- DC13300-20**   
L : 200 mm - 8 "
- DC13300-24**   
L : 240 mm - 9 1/2 "
- DC13300-30**  
L : 300 mm - 12 "

Jaws 3.5 mm  
Mors 3,5 mm



- DC13400-16**  
L : 160 mm - 6 "
- DC13400-20**  
L : 200 mm - 8 "
- DC13400-24**  
L : 240 mm - 9 1/2 "
- DC13400-30**  
L : 300 mm - 12 "



# DeBakey Atrauma Tissue Forceps

## Pinces DeBakey Atraumatiques

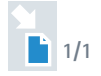

Angled - Pressure 200 gr  
Coudée - Pression 200 g



Jaws 2.0 mm  
Mors 2,0 mm



**DC13500-16**

L : 160 mm - 6 "

**DC13500-20**

L : 200 mm - 8 "

**DC13500-24**

L : 240 mm - 9 1/2 "

**DC13500-30**

L : 300 mm - 12 "

# Gerald Tissue Forceps

## Pinces Gerald

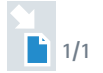

Straight - Ring Tip  
Droite - Extrémité Anneau  
Ø 1 mm



**DC14000-14**

L : 140 mm - 5 1/2 "

**DC14000-18**

L : 180 mm - 7 "

With Platform  
Avec Plateforme  
1 mm



**DC14110-14**

L : 140 mm - 5 1/2 "

**DC14110-18**

L : 180 mm - 7 "

Curved - Ring Tip  
Courbe - Extrémité Anneau  
Ø 1 mm



**DC14001-14**

L : 140 mm - 5 1/2 "

**DC14001-18**

L : 180 mm - 7 "

Smooth Jaws  
Mors Lisses  
1 mm



**DC14100-14**

L : 140 mm - 5 1/2 "

**DC14100-18**

L : 180 mm - 7 "

With Platform - Teeth : 1 x 2  
Avec Plateforme - Griffes : 1 x 2  
1 mm



**DC14210-14**

L : 140 mm - 5 1/2 "

**DC14210-18**

L : 180 mm - 7 "

With Platform - Teeth : 1 x 2  
Avec Plateforme - Griffes : 1 x 2  
1 mm



**DC14211-14**

L : 140 mm - 5 1/2 "

**DC14211-18**

L : 180 mm - 7 "

# Thumb Delicate Tissue Forceps

## Pinces Délicates

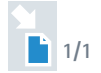

1 mm



- DC14300-12**  
L : 120 mm - 4 <sup>3</sup>/<sub>4</sub> "
- DC14300-16**  
L : 160 mm - 6 "
- DC14300-20**  
L : 200 mm - 8 "
- DC14300-24**  
L : 240 mm - 9 <sup>1</sup>/<sub>2</sub> "

2 mm



- DC14310-12**  
L : 120 mm - 4 <sup>3</sup>/<sub>4</sub> "
- DC14310-16**  
L : 160 mm - 6 "
- DC14310-20**  
L : 200 mm - 8 "
- DC14310-24**  
L : 240 mm - 9 <sup>1</sup>/<sub>2</sub> "



# Needle Pulling Forceps Pincettes pour Aiguilles

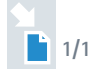

Mac Indoe



1.5 mm

DC14800-15  
L : 150 mm - 6 "

Cushing



1 mm

DC14900-18   
L : 180 mm - 7 "



# Potts-Smith Forceps

## Pinces Potts-Smith



1/1



TC Inserts



Jaws 1.8 mm  
Mors 1,8 mm

**DC15100-12**

L : 120 mm - 4 <sup>3</sup>/<sub>4</sub> "

**DC15100-14**

L : 140 mm - 5 <sup>1</sup>/<sub>2</sub> "

**DC15100-16**

L : 160 mm - 6 "

**DC15100-18**

L : 180 mm - 7 "

**DC15100-21**

L : 210 mm - 8 "

**DC15100-23**

L : 230 mm - 9 <sup>1</sup>/<sub>2</sub> "

**DC15100-25**

L : 250 mm - 10 "

# Needle Pulling and Tissue Forceps

## Pincettes pour Aiguilles

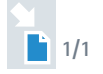

Adson Brown



B40448

L : 120 mm - 4<sup>3/4</sup>"



Wangenstein



DC15200-15

L : 150 mm - 6 "

DC15200-23

L : 230 mm - 9 "

DC15200-25

L : 250 mm - 9<sup>1/2</sup>"

# Chitwood-DeBakey Needle Pulling and Vascular Forceps

## Pinces Chitwood-DeBakey pour Aiguilles

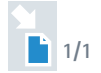

1.5 mm



**DC15400-15**

L : 150 mm - 6 "

**DC15400-20**

L : 200 mm - 8 "

**DC15400-24**

L : 240 mm - 9 1/2 "

2 mm



**DC15500-15**

L : 150 mm - 6 "

**DC15500-20**

L : 200 mm - 8 "

**DC15500-24**

L : 240 mm - 9 1/2 "



2.7 mm



**DC15600-15**

L : 150 mm - 6 "

**DC15600-20**

L : 200 mm - 8 "

**DC15600-24**

L : 240 mm - 9 1/2 "

3.5 mm



**DC15700-15**

L : 150 mm - 6 "

**DC15700-20**

L : 200 mm - 8 "

**DC15700-24**

L : 240 mm - 9 1/2 "

# Prestige Tissue Forceps

## Pincers Prestige

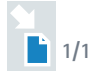

Catalogue Landanger  
Chap. II



Without Teeth  
Sans Griffes



- B86715**  
L : 140 mm - 5 1/2"
- B86720**  
L : 160 mm - 6 "
- B86725**  
L : 180 mm - 7 "



Teeth : 1 x 2  
Griffes : 1 x 2



- B86700**  
L : 140 mm - 5 1/2"
- B86705**  
L : 160 mm - 6 "
- B86710**  
L : 180 mm - 7 "

# Prestige Tissue Forceps

## Pinces Prestige

Catalogue Landanger  
Chap. II

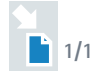

Barraya

2 x 3 Teeth  
Narrow Jaws - Squared  
2 x 3 Griffes  
Mors Étroits - Quadrillés



**B86750**

L : 160 mm - 6 "

**B86755**

L : 180 mm - 7 "

**B86760**

L : 200 mm - 7<sup>3/4</sup>"



Adlerkreutz

3 x 4 Teeth  
With Heel  
3 x 4 Griffes  
À Talon



**B86765**

L : 160 mm - 6 "

**B86770**

L : 180 mm - 7 "

**B86775**

L : 200 mm - 7<sup>3/4</sup>"



Durand

Russian Model  
Patte de Velours



**B86780**

L : 150 mm - 6 "

**B86785**

L : 200 mm - 7<sup>3/4</sup>"

# Prestige Delicate Tissue Forceps

## Pincers Délicates Prestige

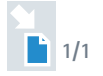

Catalogue Landanger  
Chap. II



Fine Model  
Modèle Fin

Teeth : 1 x 2  
Griffes : 1 x 2

Without Teeth  
Sans Griffes

Teeth : 1 x 2  
Griffes : 1 x 2

Without Teeth  
Sans Griffes



**B86730**  
L : 140 mm - 5 1/2 "



**B86735**  
L : 140 mm - 5 1/2 "



**B86740**  
L : 200 mm - 8 "



**B86745**  
L : 200 mm - 8 "

# Adson Tissue Forceps

## Pinces Adson

Catalogue Landanger  
Chap. II

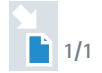

Adson  
2 mm

Micro-Adson  
1 mm



Without Teeth  
Sans Griffes

**B40440**

L : 120 mm - 4 3/4 "

**B404450**

L : 150 mm - 6 "

**B404453**

L : 180 mm - 7 "



Teeth : 1 x 2  
Griffes : 1 x 2

**B40445**

L : 120 mm - 4 3/4 "

**B404451**

L : 150 mm - 6 "

**B404454**

L : 180 mm - 7 "



Without Teeth  
Sans Griffes

**B40447**

L : 120 mm - 4 3/4 "

**B404470**

L : 150 mm - 6 "



Teeth : 1 x 2  
Griffes : 1 x 2

**B40446**

L : 120 mm - 4 3/4 "

**B404471**

L : 150 mm - 6 "

# Jeweler Tissue Forceps Pincettes d'Horloger

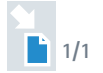

Curved  
Courbe



**DC16601-11**

L : 110 mm - 4 "



**DC17001-11**

L : 110 mm - 4 "



Straight  
Droite



**DC16600-11**

L : 110 mm - 4 "

**DC16800-13**

L : 130 mm - 5 "



**DC17000-11**

L : 110 mm - 4 "



**DC17200-13**

L : 130 mm - 5 "



45°



**DC16700-11**

L : 110 mm - 4 "

**DC16900-13**

L : 130 mm - 5 "



**DC17100-11**

L : 110 mm - 4 "



**DC17300-13**

L : 130 mm - 5 "



# Scissors Ciseaux



Micro Scissors - *Micro Ciseaux*

**Straight**  
*Droit*



P 3 - P 6

**Angled**



P 7 - P 11

**Ball Type**

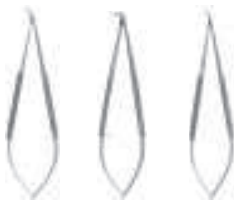

P 12 P 13 P 14

Bayonet Micro Scissors - *Micro Ciseaux à Baïonnette*



P 15 P 16

Streamline Micro Scissors - *Micro Ciseaux Streamline*



P 4 P 10 P 11

Cardiovascular Scissors - *Ciseaux Cardiovasculaires*

DeBakey Potts-Smith Hegemann Diethrich Diethrich-Potts Favarolo Beal Diethrich De Martel Merveilleux Ross



P 17 P 18 P 19 P 20 P 21 P 22 P 22 P 22 P 23 P 24 P 25

Cardiovascular Scissors - *Ciseaux Cardiovasculaires*

Lillehei-Potts Cooley Mayo Boyd DeBakey Carpentier 4 Articulations



P 25 P 26 P 26 P 27 P 28 P 29



# Scissors Ciseaux

## Paris Scissors - *Ciseaux Paris*

Metzenbaum    Stevens

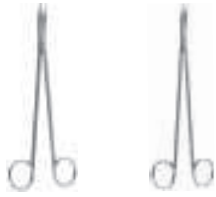

P 30

## Prestige Scissors - *Ciseaux Prestige*

Mayo

Metzenbaum

Metzenbaum Fino

Wagner

Reynolds



P 31

## TC Inserts Scissors - *Ciseaux à Lames Tungstène*

Mayo Lexer

Mayo

Metzenbaum

Metzenbaum Fino

Toennis Adson



P 36

# Micro Scissors

## Micro Ciseaux

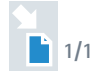

10 mm Blades - Round Handle  
Lames 10 mm - Manche Rond



Straight  
Droit



**DC20110-12**

L : 120 mm - 4 <sup>3</sup>/<sub>4</sub> "

**DC20110-18**

L : 180 mm - 7 "

Curved  
Courbe



**DC20111-12**

L : 120 mm - 4 <sup>3</sup>/<sub>4</sub> "

**DC20111-18**

L : 180 mm - 7 "



Straight - Tenotomy (Vannas)  
Droit - Ténotomie (Vannas)



**DC20112-09**

L : 90 mm - 3 <sup>1</sup>/<sub>2</sub> "

**DC20112-12**

L : 120 mm - 4 <sup>3</sup>/<sub>4</sub> "

**DC20112-18**

L : 180 mm - 7 "

Curved - Tenotomy (Vannas)  
Courbe - Ténotomie (Vannas)



**DC20113-09**

L : 90 mm - 3 <sup>1</sup>/<sub>2</sub> "

**DC20113-12**

L : 120 mm - 4 <sup>3</sup>/<sub>4</sub> "

**DC20113-18**

L : 180 mm - 7 "

# Micro Scissors Micro Ciseaux

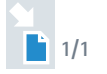

10 mm Blades  
Lames 10 mm

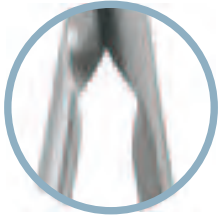

Streamline Design



Flat Handle  
Manche Plat

Straight  
Droit

**DC20150-18**  
L : 180 mm - 7 "

Curved  
Courbe

**DC20151-18**  
L : 180 mm - 7 "



Round Handle  
Manche Rond

Straight  
Droit

**DC20140-18**  
L : 180 mm - 7 "

Curved  
Courbe

**DC20141-18**  
L : 180 mm - 7 "

# Jacobson Micro Scissors

## Micro Ciseaux Jacobson

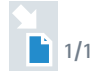

14 mm Blades - Round Handle  
Lames 14 mm - Manche Rond

Straight  
Droit

Sharp  
Pointu



**DC20010-18**  
L : 180 mm - 7 "



Curved  
Courbe

Sharp  
Pointu



**DC20011-18**   
L : 180 mm - 7 "

Blunt  
Mousse



**DC20114-18**  
L : 180 mm - 7 "

# Jacobson Micro Scissors

## Micro Ciseaux Jacobson

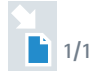

14 mm Blades - Flat Handle  
Lames 14 mm - Manche Plat

Straight  
Droit



DC20000-18  
L : 180 mm - 7 "



Curved  
Courbe



DC20001-18  
L : 180 mm - 7 "

# Jacobson Micro Scissors

## Micro Ciseaux Jacobson

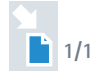

7 mm Blades - Angled - Round Handle  
Lames 7 mm - Coudé - Manche Rond

25°



**DC20055-12**

L : 120 mm - 4 3/4 "

**DC20055-18**

L : 180 mm - 7 "

90°



**DC20058-12**

L : 120 mm - 4 3/4 "

**DC20058-18**

L : 180 mm - 7 "

45°



**DC20056-12**

L : 120 mm - 4 3/4 "

**DC20056-18**

L : 180 mm - 7 "

125°



**DC20059-12**

L : 120 mm - 4 3/4 "

**DC20059-18**

L : 180 mm - 7 "

60°



**DC20057-12**

L : 120 mm - 4 3/4 "

**DC20057-18**

L : 180 mm - 7 "

Circumflex  
Circonflexe



**DC20065-12**

L : 120 mm - 4 3/4 "

**DC20065-18**

L : 180 mm - 7 "

# Jacobson Micro Scissors

## Micro Ciseaux Jacobson



10 mm Blades - Angled - Flat Handle  
Lames 10 mm - Coudé - Manche Plat





# Jacobson Micro Scissors

## Micro Ciseaux Jacobson

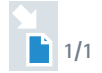

10 mm Blades - Angled - Round Handle  
Lames 10 mm - Coudé - Manche Rond

25°



**DC20060-12**  
L : 120 mm - 4 3/4 "

**DC20060-18**  
L : 180 mm - 7 "

**DC20060-21**  
L : 210 mm - 8 "

90°



**DC20063-12**  
L : 120 mm - 4 3/4 "

**DC20063-18**   
L : 180 mm - 7 "

**DC20063-21**  
L : 210 mm - 8 "

45°



**DC20061-12**  
L : 120 mm - 4 3/4 "

**DC20061-18**   
L : 180 mm - 7 "

**DC20061-21**  
L : 210 mm - 8 "

125°



**DC20064-12**  
L : 120 mm - 4 3/4 "

**DC20064-18**   
L : 180 mm - 7 "

**DC20064-21**  
L : 210 mm - 8 "

60°



**DC20062-12**  
L : 120 mm - 4 3/4 "

**DC20062-18**   
L : 180 mm - 7 "

**DC20062-21**  
L : 210 mm - 8 "



# Jacobson Micro Scissors

## Micro Ciseaux Jacobson

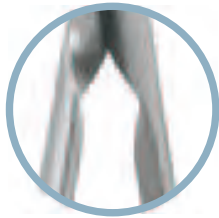
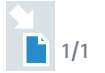

Streamline Design

10 mm Blades - Angled - Flat Handle  
Lames 10 mm - Coudé - Manche Plat



25°



**DC20152-18**

L : 180 mm - 7 "

45°



**DC20153-18**

L : 180 mm - 7 "

60°



**DC20154-18**

L : 180 mm - 7 "

90°



**DC20155-18**

L : 180 mm - 7 "

125°



**DC20156-18**

L : 180 mm - 7 "

# Jacobson Micro Scissors

## Micro Ciseaux Jacobson



10 mm Blades - Angled - Round Handle  
Lames 10 mm - Coudé - Manche Rond

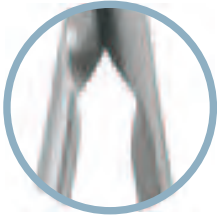

Streamline Design



25°



**DC20142-18**

L : 180 mm - 7 "

45°



**DC20143-18**

L : 180 mm - 7 "

60°



**DC20144-18**

L : 180 mm - 7 "

90°



**DC20145-18**

L : 180 mm - 7 "

125°



**DC20146-18**

L : 180 mm - 7 "

## Ball Type Micro Scissors

### Micro Ciseaux à Extrémité Sphérique



7 mm Blades - Angled - Ball 1 mm - Round Handle  
Lames 7 mm - Coudé - Sphère 1 mm - Manche Rond

25°



**DC20160-12**

L : 120 mm - 4 3/4 "

**DC20160-18**

L : 180 mm - 7 "

45°



**DC20161-12**

L : 120 mm - 4 3/4 "

**DC20161-18**

L : 180 mm - 7 "

60°



**DC20162-12**

L : 120 mm - 4 3/4 "

**DC20162-18**

L : 180 mm - 7 "

90°



**DC20163-12**

L : 120 mm - 4 3/4 "

**DC20163-18**

L : 180 mm - 7 "

125°



**DC20164-12**

L : 120 mm - 4 3/4 "

**DC20164-18**

L : 180 mm - 7 "



# Ball Type Micro Scissors

## Micro Ciseaux à Extrémité Sphérique

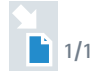

10 mm Blades - Angled - Ball 1.5 mm - Flat Handle  
Lames 10 mm - Coudé - Sphère 1,5 mm - Manche Plat



**DC20130-18**  
L : 180 mm - 7 "



**DC20131-18**  
L : 180 mm - 7 "



**DC20132-18**  
L : 180 mm - 7 "



**DC20133-18**  
L : 180 mm - 7 "



**DC20134-18**  
L : 180 mm - 7 "

## Ball Type Micro Scissors

### Micro Ciseaux à Extrémité Sphérique



10 mm Blades - Angled - Ball 1.5 mm - Round Handle  
Lames 10 mm - Coudé - Sphère 1,5 mm - Manche Rond



25°

DC20120-18

L : 180 mm - 7 "

45°

DC20121-18

L : 180 mm - 7 "

60°

DC20122-18

L : 180 mm - 7 "

90°

DC20123-18

L : 180 mm - 7 "

125°

DC20124-18

L : 180 mm - 7 "

# Bayonet Micro Scissors

## Micro Ciseaux Baïonnette

Buck Gramcko

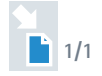

Straight  
Droit



**DC20032-18**

L : 185 mm - 7 1/4 "

Curved  
Courbe



**DC20033-18**

L : 185 mm - 7 1/4 "



125°



**DC20040-18**

L : 180 mm - 7 "

# Bayonet Micro Scissors

## Micro Ciseaux Baïonnette

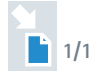

Straight  
Droit

- DC20100-19  
L : 190 mm - 7 1/2 "
- DC20100-22  
L : 225 mm - 8 3/4 "
- DC20100-24  
L : 240 mm - 9 1/2 "

Curved  
Courbe

- DC20101-19  
L : 190 mm - 7 1/2 "
- DC20101-22   
L : 225 mm - 8 3/4 "
- DC20101-24  
L : 240 mm - 9 1/2 "



Straight - Tenotomy (Vannas)  
Droit - Ténotomie (Vannas)

- DC20102-19  
L : 190 mm - 7 1/2 "
- DC20102-22   
L : 225 mm - 8 3/4 "
- DC20102-24  
L : 240 mm - 9 1/2 "

Curved - Tenotomy (Vannas)  
Courbe - Ténotomie (Vannas)

- DC20103-19  
L : 190 mm - 7 1/2 "
- DC20103-22   
L : 225 mm - 8 3/4 "
- DC20103-24  
L : 240 mm - 9 1/2 "



# DeBakey Cardiovascular Scissors

## Ciseaux Cardiovasculaires DeBakey

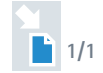

Sharp  
Pointu

25°

**DC21100-14**

L : 140 mm - 5 1/2 "

**DC21100-17**

L : 165 mm - 6 1/2 "

**DC21103-22**

L : 225 mm - 8 1/4 "

**DC21106-28**

L : 280 mm - 11 "

Angled  
Coudé

Blunt  
Mousse

25°

**DC21103-14**

L : 140 mm - 5 1/2 "

**DC21103-17**

L : 165 mm - 6 1/2 "

45°

**DC21101-14**

L : 140 mm - 5 1/2 "

**DC21101-17**

L : 165 mm - 6 1/2 "

**DC21104-22**

L : 220 mm - 8 1/4 "

**DC21107-28**

L : 280 mm - 11 "

45°

**DC21104-14**

L : 140 mm - 5 1/2 "

**DC21104-17**

L : 165 mm - 6 1/2 "

60°

**DC21102-14**

L : 140 mm - 5 1/2 "

**DC21102-17**

L : 165 mm - 6 1/2 "

**DC21105-22**

L : 220 mm - 8 1/4 "

**DC21108-28**

L : 280 mm - 11 "

60°

**DC21105-14**

L : 140 mm - 5 1/2 "

**DC21105-17**

L : 165 mm - 6 1/2 "



# Potts-Smith Cardiovascular Scissors

## Ciseaux Cardiovasculaires Potts-Smith

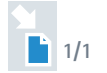

Angled  
Coudé



25°



**DC21150-15**

L : 150 mm - 5 <sup>7</sup>/<sub>8</sub> "

**DC21150-19**

L : 190 mm - 7 <sup>1</sup>/<sub>2</sub> "

45°



**DC21151-15**

L : 150 mm - 5 <sup>7</sup>/<sub>8</sub> "

**DC21151-19**

L : 190 mm - 7 <sup>1</sup>/<sub>2</sub> "

60°



**DC21152-15**

L : 150 mm - 5 <sup>7</sup>/<sub>8</sub> "

**DC21152-19**

L : 190 mm - 7 <sup>1</sup>/<sub>2</sub> "

# Hegemann Cardiovascular Scissors

## Ciseaux Cardiovasculaires Hegemann

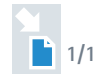

Angled  
Coudé



25°



**DC21211-15**

L : 150 mm - 5 7/8 "

**DC21211-19**

L : 190 mm - 7 1/2 "

45°



**DC21212-15**

L : 150 mm - 5 7/8 "

**DC21212-19**

L : 190 mm - 7 1/2 "

60°



**DC21213-15**

L : 150 mm - 5 7/8 "

**DC21213-19**

L : 190 mm - 7 1/2 "

90°



**DC21214-15**

L : 150 mm - 5 7/8 "

**DC21214-19**

L : 190 mm - 7 1/2 "

125°



**DC21215-15**

L : 150 mm - 5 7/8 "

**DC21215-19**

L : 190 mm - 7 1/2 "

# Diethrich Cardiovascular Scissors Ciseaux Cardiovasculaires Diethrich

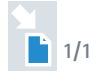

Angled  
Coudé



25°



**DC21221-13**

L : 130 mm - 5 "

**DC21221-18**

L : 180 mm - 7 "

45°



**DC21222-13**

L : 130 mm - 5 "

**DC21222-18**

L : 180 mm - 7 "

60°



**DC21223-13**

L : 130 mm - 5 "

**DC21223-18**

L : 180 mm - 7 "

90°



**DC21224-13**

L : 130 mm - 5 "

**DC21224-18**

L : 180 mm - 7 "

125°



**DC21225-13**

L : 130 mm - 5 "

**DC21225-18**

L : 180 mm - 7 "

# Diethrich-Potts Cardiovascular Scissors Ciseaux Cardiovasculaires Diethrich-Potts

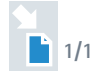

Angled  
Coudé



25°



**DC21170-14**

L : 140 mm - 5 1/2 "

**DC21170-18**

L : 180 mm - 7 1/2 "

45°



**DC21171-14**

L : 140 mm - 5 1/2 "

**DC21171-18**

L : 180 mm - 7 1/2 "

60°



**DC21172-14**

L : 140 mm - 5 1/2 "

**DC21172-18**

L : 180 mm - 7 1/2 "

90°



**DC21173-14**

L : 140 mm - 5 1/2 "

**DC21173-18**

L : 180 mm - 7 1/2 "

125°



**DC21174-14**

L : 140 mm - 5 1/2 "

**DC21174-18**

L : 180 mm - 7 1/2 "

# Cardiovascular Scissors Ciseaux Cardiovasculaires

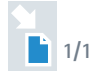

115°

**Beall Circumflex**

- DC21260-00**  
L : 150 mm - 6 " - Sharp / Pointu
- DC21261-00**  
L : 150 mm - 6 " - Blunt / Mousse

125°

**Favaloro**

- DC21320-18**  
L : 180 mm - 7 "  
Fine / Fin 125°

125°

**Diethrich**

- DC21300-17**  
L : 170 mm - 6 3/4 "  
With Ratchet / À Crémaillère

# De Martel Cardiovascular Scissors

## Ciseaux Cardiovasculaires De Martel

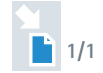

Straight - Blunt  
Droit - Mousse



**DC21273-14**

L : 140 mm - 5 1/2 "

**DC21273-17**

L : 175 mm - 6 3/4 "

Curved - Sharp  
Courbe - Pointu



**DC21276-14**

L : 140 mm - 5 1/2 "

**DC21276-17**

L : 170 mm - 6 3/4 "

Curved - Blunt  
Courbe - Mousse



**DC21272-14**

L : 140 mm - 5 1/2 "

**DC21272-17**

L : 170 mm - 6 3/4 "

Angled - Sharp  
Coudé - Pointu



**DC21275-14**

L : 140 mm - 5 1/2 "

**DC21275-00**

L : 180 mm - 7 "

Angled - Sharp  
Coudé - Pointu



**DC21270-14**

L : 140 mm - 5 1/2 "

**DC21270-00**

L : 180 mm - 7 "

Angled - Blunt  
Coudé - Mousse



**DC21274-14**

L : 140 mm - 5 1/2 "

**DC21274-00**

L : 180 mm - 7 "



# Merveilleux Cardiovascular Scissors

## Ciseaux Cardiovasculaires Merveilleux

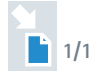

Angled - Sharp  
Coudé - Pointu



45°

**DC21233-17**

L : 170 mm - 6 1/2 "

Fine - Sharp  
Fin - Pointu



**DC21235-14**

L : 140 mm - 5 1/2 "

**DC21235-17**

L : 170 mm - 6 1/2 "

Angled - Blunt  
Coudé - Mousse



**DC21232-14**

L : 140 mm - 5 1/2 "

**DC21232-17**

L : 170 mm - 6 1/2 "

Curved - Blunt  
Courbe - Mousse



**DC21230-14**

L : 140 mm - 5 1/2 "

**DC21230-17**

L : 170 mm - 6 1/2 "

Curved - Sharp  
Courbe - Pointu



**DC21231-14**

L : 140 mm - 5 1/2 "

**DC21231-17**

L : 170 mm - 6 1/2 "

Straight - Sharp  
Droit - Pointu



**DC21234-14**

L : 140 mm - 5 1/2 "

**DC21234-17**

L : 170 mm - 6 1/2 "





# Cardiovascular Scissors Ciseaux Cardiovasculaires

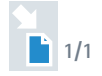

## Ross

Fine - Lightly Curved  
Fin - Légèrement Courbe



DC21220-14

L : 140 mm - 5 1/2 "

DC21220-17

L : 170 mm - 6 3/4 "

## Lillehei-Potts

Straight  
Droit



DC21180-14

L : 140 mm - 5 1/2 "

DC21180-18

L : 180 mm - 7 "

Curved  
Courbe



DC21181-14

L : 140 mm - 5 1/2 "

DC21181-18

L : 180 mm - 7 "

# Cardiovascular Scissors Ciseaux Cardiovasculaires

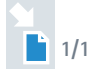

Cooley Mayo



Boyd



# DeBakey Cardiovascular Scissors

## Ciseaux Cardiovasculaires DeBakey

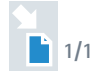

Blunt  
Mousse

**DC21112-17**

L : 175 mm - 6 3/4"

Sharp  
Pointu

Straight  
Droit

**DC21130-14**

L : 140 mm - 5 1/2"

**DC21130-18**

L : 180 mm - 7"

Curved  
Courbe

**DC21131-14**

L : 140 mm - 5 1/2"

**DC21131-18**

L : 180 mm - 7"

Angled  
Coudé

90°

**DC21132-18**

L : 180 mm - 7"

# Carpentier Cardiovascular Scissors Ciseaux Cardiovasculaires Carpentier

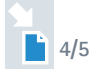

Supercut

Papillary Muscles Scissors  
Ciseaux pour Muscles Papillaires

85°



Scale - Échelle : 1/1



DC21050-18

L : 180 mm - 7 "

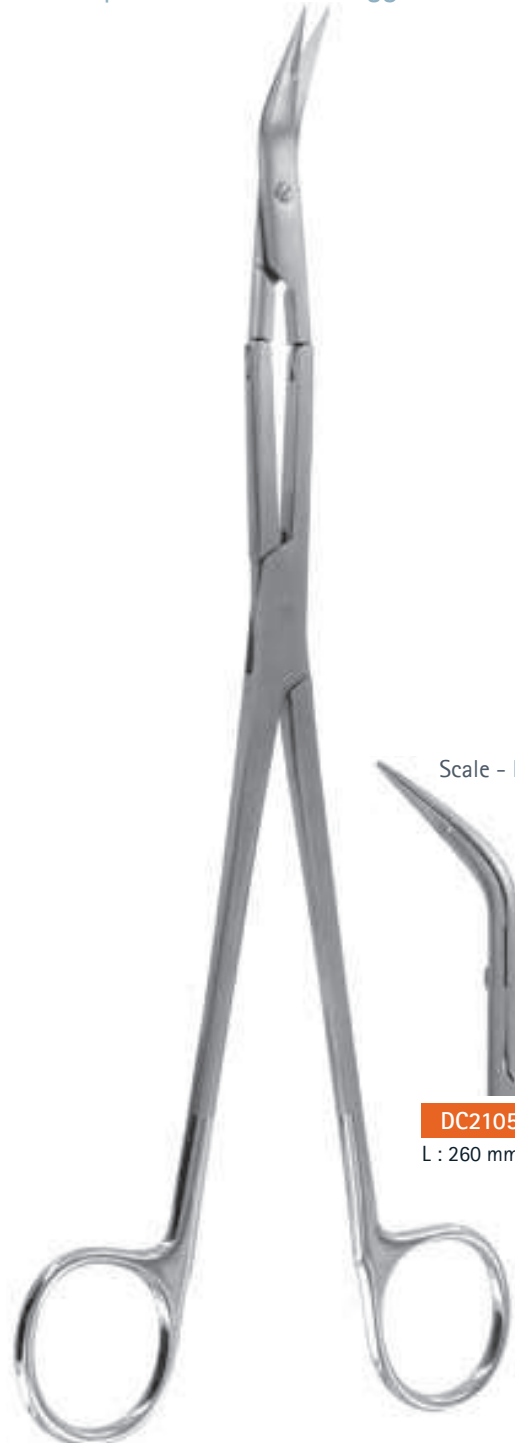

Scale - Échelle : 1/1



DC21050-26

L : 260 mm - 10 "

# Cardiovascular Scissors Ciseaux Cardiovasculaires

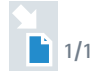

4 Articulations

Straight  
Droit



**DC21000-24**

L : 240 mm - 9 1/2"

**DC21000-27**

L : 270 mm - 10 1/2"

Curved  
Courbe



**DC21001-24**

L : 240 mm - 9 1/2"

**DC21001-27**

L : 270 mm - 10 1/2"



# Paris Scissors Ciseaux Paris

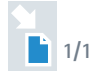

## Metzenbaum

## Stevens



Curved  
Courbe

**DC21400-18**

L : 180 mm - 7 "

**DC21400-20**

L : 200 mm - 7 4/5 "

**DC21400-23**

L : 230 mm - 9 "



Curved  
Courbe

**DC21410-18**

L : 180 mm - 7 "

**DC21410-20**

L : 200 mm - 7 4/5 "

**DC21410-23**

L : 230 mm - 9 "

# Prestige Mayo Scissors

## Ciseaux Prestige Mayo

Catalogue Landanger  
Chap. III

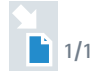

Straight  
Droit

Curved  
Courbe

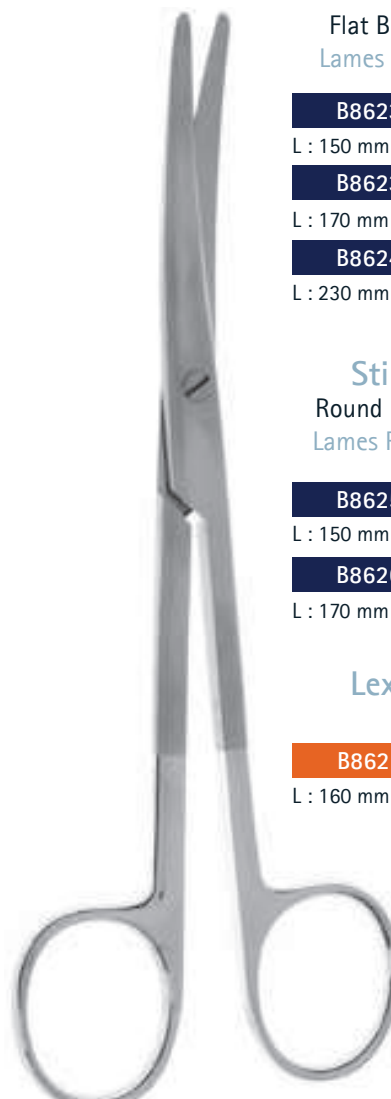
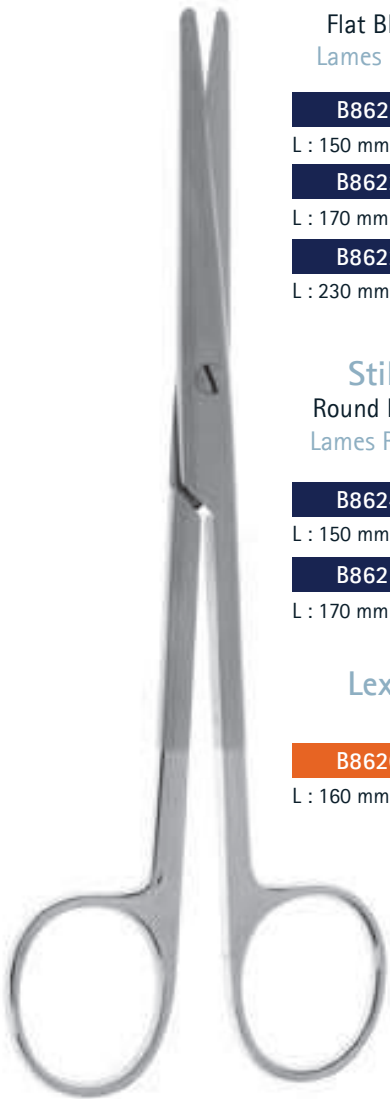

Flat Blades  
Lames Plates

Flat Blades  
Lames Plates

**B86215**

L : 150 mm - 6 "

**B86220**

L : 170 mm - 6 <sup>3</sup>/<sub>4</sub> "

**B86225**

L : 230 mm - 9 "

**B86230**

L : 150 mm - 6 "

**B86235**

L : 170 mm - 6 <sup>3</sup>/<sub>4</sub> "

**B86240**

L : 230 mm - 9 "

Stille  
Round Blades  
Lames Rondes

Stille  
Round Blades  
Lames Rondes

**B86245**

L : 150 mm - 6 "

**B86250**

L : 170 mm - 6 <sup>3</sup>/<sub>4</sub> "

**B86255**

L : 150 mm - 6 "

**B86260**

L : 170 mm - 6 <sup>3</sup>/<sub>4</sub> "

Lexer

Lexer

**B86205**

L : 160 mm - 6 <sup>1</sup>/<sub>2</sub> "

**B86210**

L : 160 mm - 6 <sup>1</sup>/<sub>2</sub> "

# Prestige Metzenbaum Scissors

## Ciseaux Prestige Metzenbaum

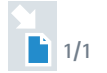

Catalogue Landanger  
Chap. III



Supercut



Straight  
Droit

**B86265**

L : 115 mm - 4 1/2"

**B86275**

L : 145 mm - 5 3/4"

**B86280**

L : 180 mm - 7 "



Curved  
Courbe

**B86270**

L : 115 mm - 4 1/2"

**B86285**

L : 145 mm - 5 3/4"

**B86290**

L : 180 mm - 7 "

**B86295**

L : 200 mm - 7 3/4"

**B86300**

L : 230 mm - 7 3/4"



# Prestige Metzenbaum Fino Scissors

## Ciseaux Prestige Metzenbaum Fino

Catalogue Landanger  
Chap. III

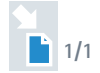

Straight  
Droit

**B86305**

L : 145 mm - 5 <sup>3</sup>/<sub>4</sub>"

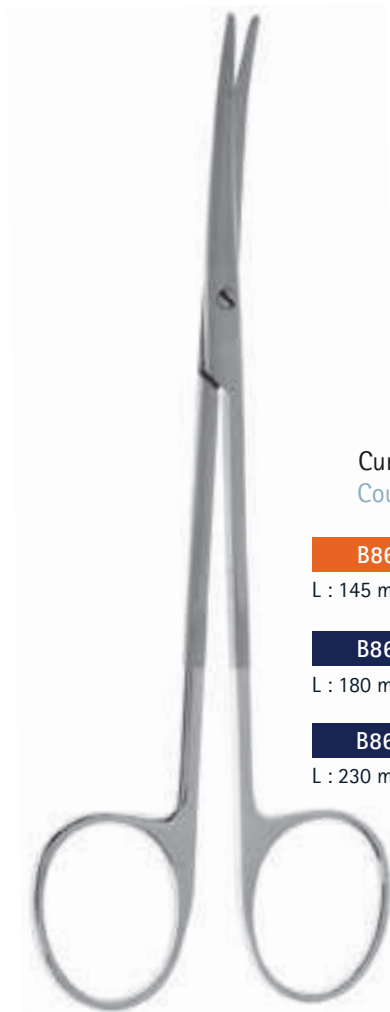

Curved  
Courbe

**B86310**

L : 145 mm - 5 <sup>3</sup>/<sub>4</sub>"

**B86315**

L : 180 mm - 8 "

**B86320**

L : 230 mm - 9 "

# Prestige Scissors Ciseaux Prestige



Catalogue Landanger  
Chap. III



Supercut

Straight - Sharp  
Droit - Pointu



**B86325**

L : 115 mm - 4 1/2"

Wagner

Straight - Sharp  
Droit - Pointu



**B86335**

L : 120 mm - 4 3/4"

Curved - Sharp  
Courbe - Pointu



**B86330**

L : 115 mm - 4 1/2"

Wagner

Curved - Sharp  
Courbe - Pointu



**B86340**

L : 120 mm - 4 3/4"

Delicate - Curved - Blunt - Narrow  
Délicat - Courbe - Mousse - Étroit



**B86345**

L : 110 mm - 4 1/2"

**B86350**

L : 140 mm - 5 1/2"

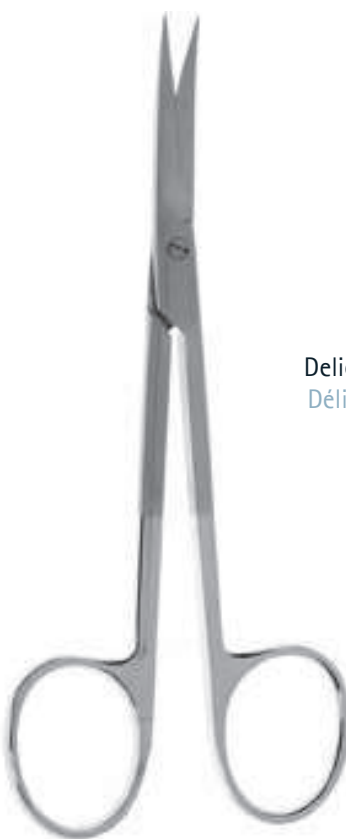

# Prestige Scissors Ciseaux Prestige

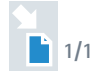

Catalogue Landanger  
Chap. III



## Reynolds

Straight  
Droit



**B86370**

L : 150 mm - 6 "

## Reynolds

Curved  
Courbe



**B86365**

L : 130 mm - 5 "

**B86375**

L : 150 mm - 6 "



## Jameson

Curved  
Courbe



**B86380**

L : 150 mm - 6 "

**B86385**

L : 180 mm - 7 "

# Mayo Lexer Scissors Ciseaux Mayo Lexer

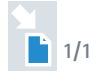

Catalogue Landanger  
Chap. III



Straight  
Droit

**B35007**  
L : 160 mm - 6 1/2"



Curved  
Courbe

**B35008**  
L : 160 mm - 6 1/2"

# Mayo Scissors Ciseaux Mayo

Catalogue Landanger  
Chap. III

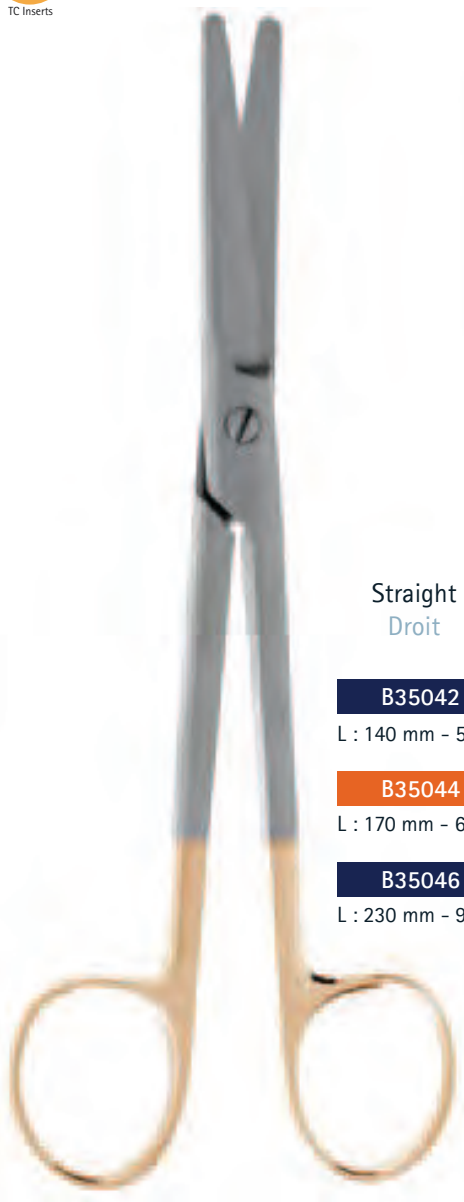
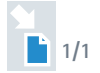

Straight  
Droit

**B35042**

L : 140 mm - 5 1/2"

**B35044**

L : 170 mm - 6 3/4"

**B35046**

L : 230 mm - 9 "



Curved  
Courbe

**B35043**

L : 140 mm - 5 1/2"

**B35045**

L : 170 mm - 6 3/4"

**B35047**

L : 230 mm - 9 "

# Metzenbaum Scissors

## Ciseaux Metzenbaum



Catalogue Landanger  
Chap. III

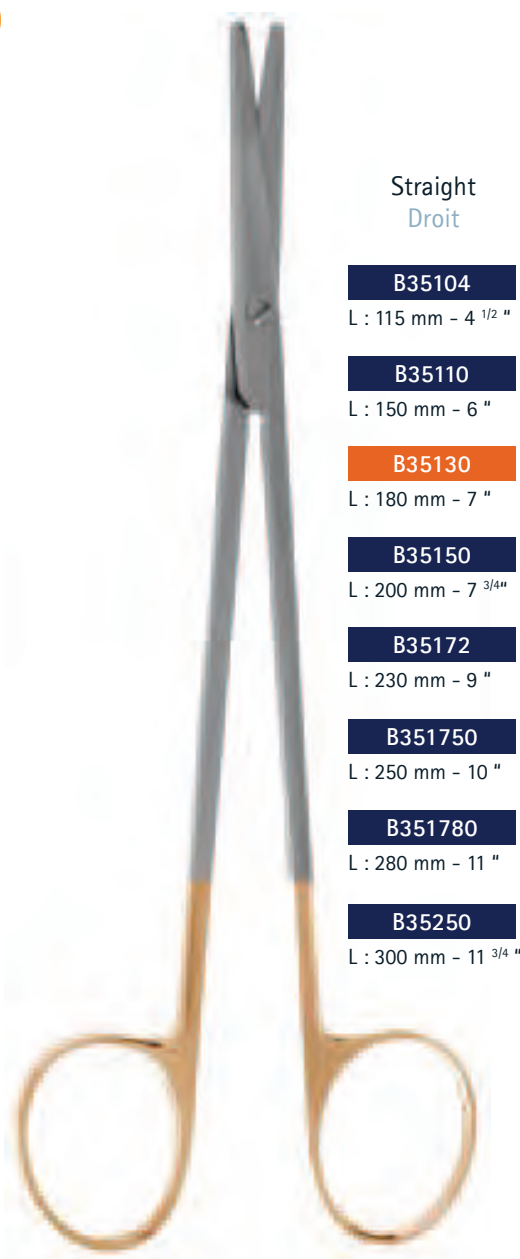

Straight  
Droit

**B35104**

L : 115 mm - 4 1/2 "

**B35110**

L : 150 mm - 6 "

**B35130**

L : 180 mm - 7 "

**B35150**

L : 200 mm - 7 3/4 "

**B35172**

L : 230 mm - 9 "

**B351750**

L : 250 mm - 10 "

**B351780**

L : 280 mm - 11 "

**B35250**

L : 300 mm - 11 3/4 "



Curved  
Courbe

**B35106**

L : 115 mm - 4 1/2 "

**B35120**

L : 150 mm - 6 "

**B35140**

L : 180 mm - 7 "

**B35160**

L : 200 mm - 7 3/4 "

**B35174**

L : 230 mm - 9 "

**B351751**

L : 250 mm - 10 "

**B351781**

L : 280 mm - 11 "

**B35240**

L : 300 mm - 11 3/4 "

# Metzenbaum Fino Scissors

## Ciseaux Metzenbaum Fino

Catalogue Landanger  
Chap. III

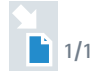

Straight  
Droit

**B35048**

L : 150 mm - 6 "

**B35050**

L : 180 mm - 7 "

**B35070**

L : 200 mm - 8 "

**B35090**

L : 230 mm - 9 "

**B351010**

L : 250 mm - 10 "

**B351020**

L : 280 mm - 11 "



Curved  
Courbe

**B35049**

L : 150 mm - 6 "

**B35060**

L : 180 mm - 7 "

**B35080**

L : 200 mm - 8 "

**B35100**

L : 230 mm - 9 "

**B351011**

L : 250 mm - 10 "

**B351021**

L : 280 mm - 11 "

# Scissors Ciseaux

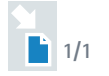

Catalogue Landanger  
Chap. III



## Metzenbaum Fino

Double Curved  
Double Courbure

## Toennis Adson



**B35228**  
L : 150 mm - 6 "

**B35230**  
L : 180 mm - 7 "

**B35232**  
L : 200 mm - 8 "

**B35234**  
L : 230 mm - 9 "



**B35260**  
L : 180 mm - 7 "



# Retractors

## Écarteurs



### Autostatic Retractors - Écarteurs Autostatiques

Carpentier

Carpentier Pediatric  
Carpentier Pédiatrique

Ministernotomy IMA  
AMI Mini-Sternotomie

IMA Couëtil

Bypass

Dubost



P 3 - P 5

P 6

P 7

P 8 - P 9

P 10 - P 11

P 12 - P 13

### Autostatic Retractors - Écarteurs Autostatiques

Finochietto-Mathey

Accessories  
Accessoires

Direct Vision



P 14 - P 15

P 16

P 17

P 18 - P 19

Tuffier

Morse Favaloro

Cardio System

Finochietto

Cooley



P 20

P 21

P 22 - P 23

P 24 - P 25

P 26 - P 27 - P 28

Burford

Ankeney

Articulated-Arms  
Bras Articulés

Scoville



P 29 - P 30

P 31

P 34

P 35



# Retractors

## Écarteurs

### Retractors - *Écarteurs*

Alm Beckmann Weitlaner Epicardial

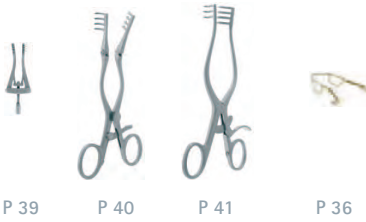

### Rib Contractors - *Rapprocheurs de Côtes*



### Hand Retractors - *Écarteurs à main*

Carpentier Chevret Harrington Lardenois Gill-Vernet Desmarres



Dubost Kocher Simon Allison Deaver Bloch



### Mitral Retractors - *Écarteurs Mitral*

Cooley Davidson



### Hooks, Spatulas and Dissectors - *Crochets, Spatules et Dissecteurs*

Carpentier Natali Mitral



# Carpentier Mitral Valve Retractor

## Écarteur Carpentier pour Valve Mitrale

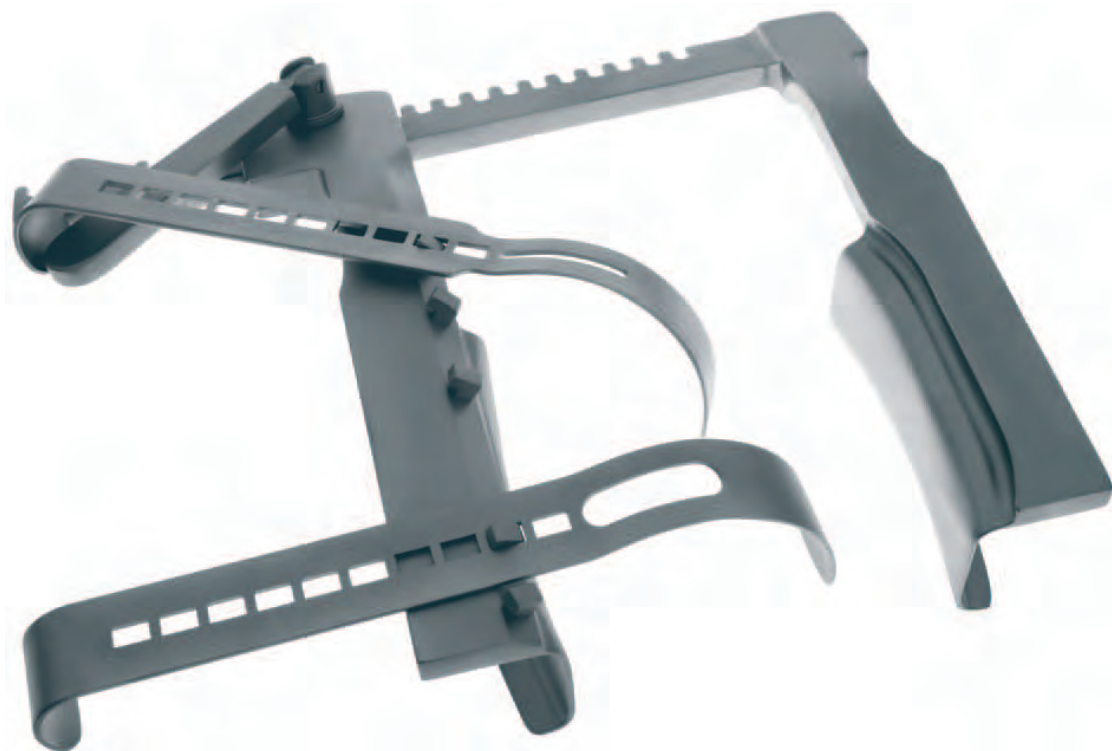
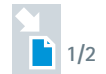

### DC30000-00

Mobile arm on the left / Bras mobile à gauche

a : 98 mm - b : 39 mm - c max : 180 mm - d : 175 mm

Included / Inclus : DC30040-15 (pair / paire)  
DC30050-25 (pair / paire)

### DC30001-00

Mobile arm on the right / Bras mobile à droite

a : 98 mm - b : 39 mm - c max : 180 mm - d : 175 mm

Included / Inclus : DC30040-15 (pair / paire)  
DC30050-25 (pair / paire)

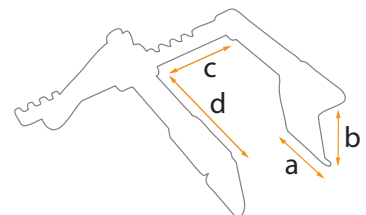

# Carpentier Mitral Valve Retractor

## Écarteur Carpentier pour Valve Mitrale

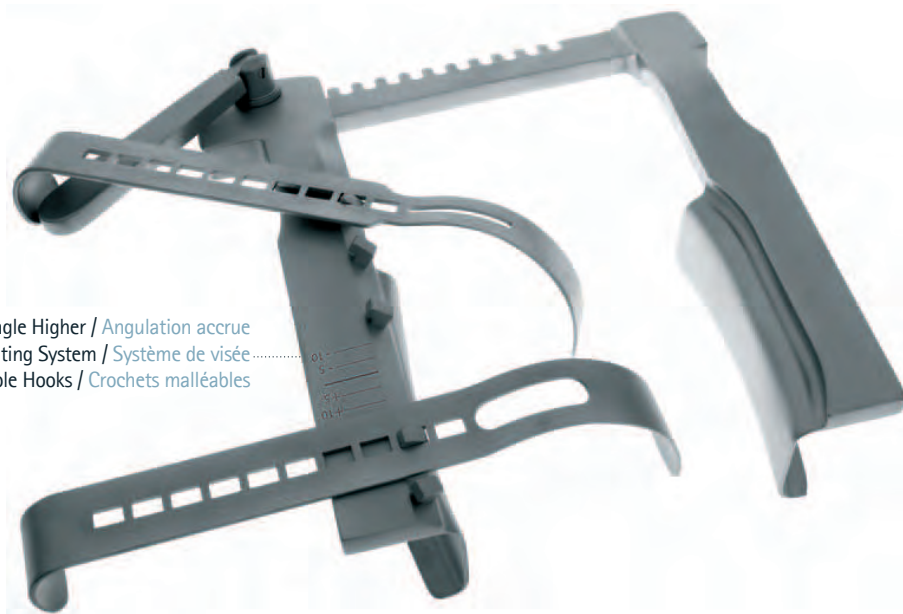
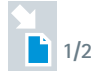

Hooks Angle Higher / Angulation accrue  
Sighting System / Système de visée  
Malleable Hooks / Crochets malléables

DC30002-00

a : 98 mm - b : 39 mm - c max : 120 mm - d : 175 mm

Included / Inclus : DC30040-15 (pair / paire)  
DC30050-25 (pair / paire)

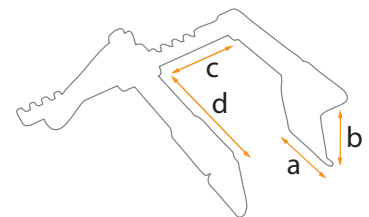

# Carpentier Retractor Hooks

## Crochets pour Écarteur Carpentier



Malleable Hooks  
Crochets Malléables

No Scale - Pas d'Échelle



**DC30010-00**

Included / Inclus : DC30020-00  
DC30030-00



**DC30030-00** Unit / Unité

L : 225 mm - Width / Largeur : 16 mm  
Thickness / Épaisseur : 2 mm



**DC30020-00**



**DC30040-15** Pair / Paire

L : 195 mm - Width / Largeur : 16 mm  
Thickness / Épaisseur : 2 mm



**DC30050-25** Pair / Paire

L : 190 mm - Width / Largeur : 24 mm  
Thickness / Épaisseur : 2 mm

# Carpentier Pediatric Mitral Valve Retractor

## Écarteur Pédiatrique Carpentier

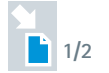

DC30100-00

a : 55 mm – b : 16 mm – c max : 120 mm – d : 103 mm

Included 1 pair of hooks / Inclus 1 paire de crochets : 120 mm x 9 mm

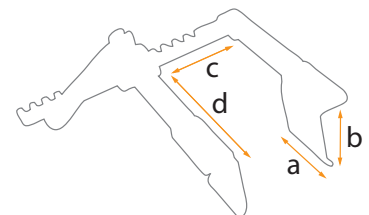

# Mini Sternotomy IMA Retractor

## Écarteur Mini-Sternotomie pour AMI

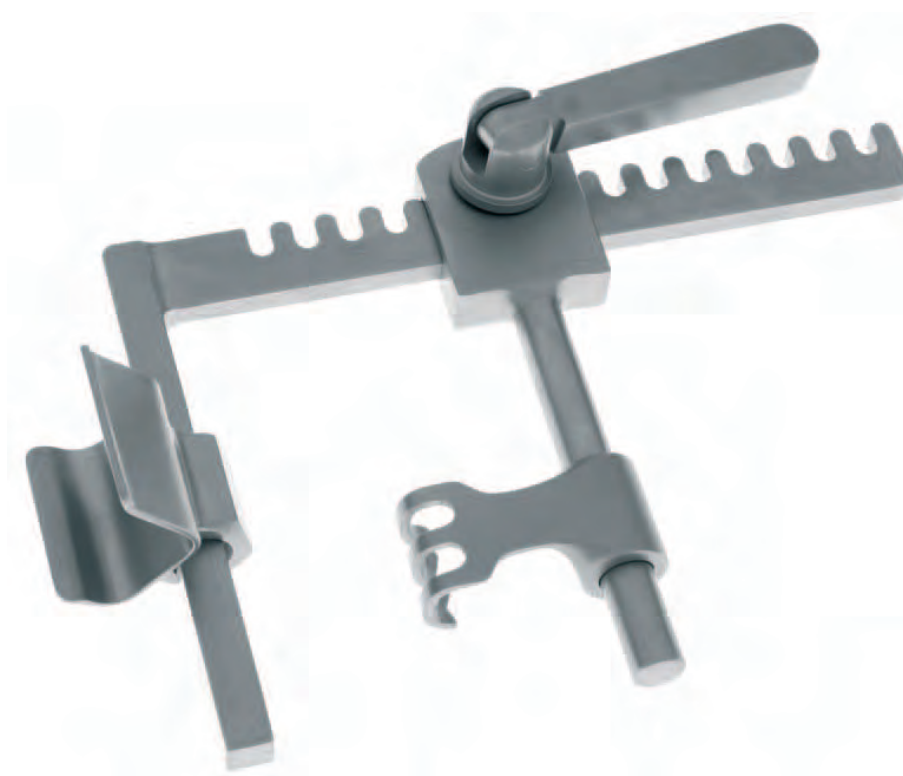
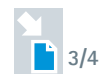

**DC30300-00**

a : 30 mm – b : 20 mm – c max : 120 mm – d : 75 mm

Included / Inclus : DC30222-38 : Hook / Crochet - L : 38 mm

DC30223-43 : Hook / Crochet - L : 43 mm

DC30212-20 : "U" Shape Blade / Valve "U" - a : 38 mm

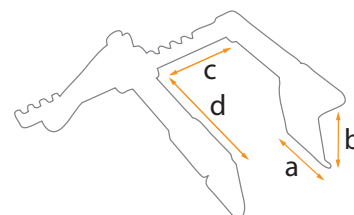

# IMA Couëtil Sternal Retractor

## Écarteur Sternal AMI Couëtil

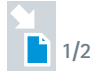

Patented - Breveté



DC30200-00

a : 98 mm - b : 23 mm - c max : 205 mm - d : 180 mm

Included / Inclus : DC30210-20  
DC30220-28  
DC30221-32

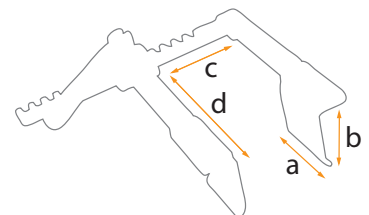



# IMA Couëtil Retractor Accessories

## Accessoires pour Écarteur AMI Couëtil

3/4



**DC30210-20**

a : 100 mm - b : 20 mm - "U" Shape / Valve "U"

**DC30211-25**

a : 100 mm - b : 25 mm - "U" Shape / Valve "U"



**DC30212-20**

a : 30 mm - b : 20 mm - "U" Shape / Valve "U"



**W Sharp / Pointu**

**DC30219-23**

L : 23 mm - W : 20 mm

**DC30220-28**

L : 28 mm - W : 20 mm

**DC30221-32**

L : 32 mm - W : 20 mm

**DC30222-38**

L : 38 mm - W : 20 mm

**DC30223-43**

L : 43 mm - W : 20 mm

**DC30224-50**

L : 50 mm - W : 20 mm



**Blunt / Mousse**

**DC30229-23**

L : 23 mm - W : 20 mm

**DC30230-28**

L : 28 mm - W : 20 mm

**DC30231-32**

L : 32 mm - W : 20 mm

**DC30232-38**

L : 38 mm - W : 20 mm

**DC30233-43**

L : 43 mm - W : 20 mm

**DC30234-50**

L : 50 mm - W : 20 mm



**DC30250-00**

Adjustable Hook / Crochet Ajustable : L : 120 mm

# Bypass+ Retractor

## Écarteur Bypass+

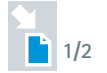

Patented - Breveté

IMA set-up / Configuration AMI



Dubost set-up / Configuration Dubost



DC30700-00

c max : 230 mm - d : 170 mm

Included / Inclus : DC30710-28  
 DC30711-32  
 DC30722-25  
 DC30731-30 (pair / paire)  
 DC30732-40 (pair / paire)  
 DC30733-50 (pair / paire)

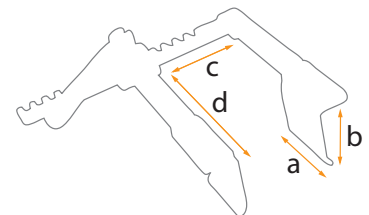

# Bypass+ Retractor Dubost Accessories

## Accessoires pour Écarteur Bypass+ Dubost

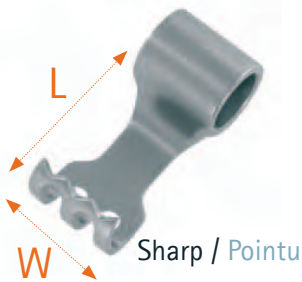
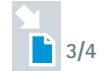

Sharp / Pointu

**DC30709-23**

L : 23 mm - W : 20 mm

**DC30710-28**

L : 28 mm - W : 20 mm

**DC30711-32**

L : 32 mm - W : 20 mm

**DC30712-38**

L : 38 mm - W : 20 mm

**DC30714-43**

L : 43 mm - W : 20 mm

**DC30713-50**

L : 50 mm - W : 20 mm



**DC30714-00**

Ajustable atrauma hook - L : 120 mm

Crochet Ajustable Atraumatique - L : 120 mm



"U" shape / Valve "U"

**DC30720-10**

a : 30 mm - b : 20 mm

**DC30721-20**

a : 100 mm - b : 20 mm

**DC30722-25**

a : 100 mm - b : 25 mm



**DC30730-30** Pair / Paire

a : 75 mm - b : 30 mm



**DC30731-30** Pair / Paire

a : 97 mm - b : 30 mm

**DC30732-40**

a : 97 mm - b : 40 mm

**DC30733-50**

a : 97 mm - b : 50 mm



**DC30740-00** Unit / Unité

Sternal approximator - L : 97 mm

Approximateur Sternal - L : 97 mm

# Dubost Thoracic Retractor

## Écarteur Thoracique Dubost

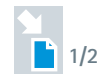

**DC30400-00**

a : 97 mm - c max : 195 mm - d : 145 mm

Included / Inclus : DC30420-30 (pair / paire)  
 DC30421-40 (pair / paire)  
 DC30422-50 (pair / paire)

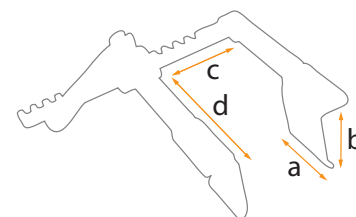

# Dubost Thoracic Retractor Accessories

## Accessoires pour Écarteur Thoracique Dubost



DC30420-30



DC30421-40



DC30422-50



DC30412-32 Pair / Paire

a : 75 mm - b : 30 mm - ASIA model / Modèle ASIE

DC30420-30 Pair / Paire

a : 97 mm - b : 30 mm

DC30421-40 Pair / Paire

a : 97 mm - b : 40 mm

DC30422-50 Pair / Paire

a : 97 mm - b : 50 mm

DC30430-00 Unit / Unité

Dubost Sternum Approximator - L : 97 mm

Approximateur Dubost pour Sternum - L : 97 mm

DC30430-00



Dubost Blade for Silicone Pad  
Valve Dubost pour Protection Silicone

DC30424-40



Silicone Pad  
Protection Silicone

DC30991-40



# Finochietto-Mathey Thoracic Retractor

## Écarteur Thoracique Finochietto-Mathey

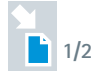

### DC30500-00

c max : 190 mm - d : 160 mm

Included / Inclus : DC30510-22 (pair / paire)  
 DC30511-30 (pair / paire)  
 DC30512-35 (pair / paire)  
 DC30513-50 (pair / paire)

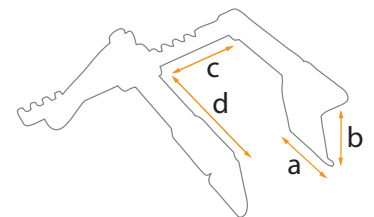

# Finochietto-Mathey Thoracic Retractor Accessories

## Accessoires pour Écarteur Finochietto-Mathey

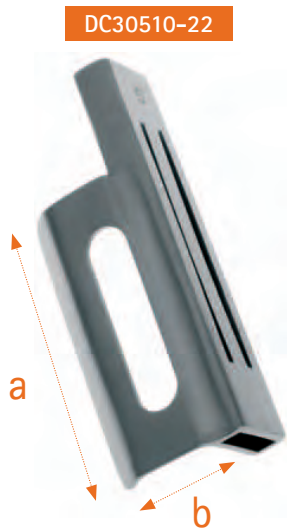
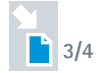

**DC30510-22** Pair / Paire

a : 58 mm - b : 22 mm

**DC30511-30** Pair / Paire

a : 38 mm - b : 30 mm

**DC30512-35** Pair / Paire

a : 62 mm - b : 35 mm

**DC30513-50** Pair / Paire

a : 65 mm - b : 50 mm

# Mini Finochietto-Mathey Retractor

## Écarteur Finochietto-Mathey Mini

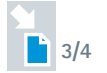

**DC30600-00**

c max : 130 mm - d : 105 mm

Included : 3 pairs of blades / 3 paires de valves incluses

a : 40 mm - b : 25 mm

a : 40 mm - b : 35 mm

a : 40 mm - b : 40 mm

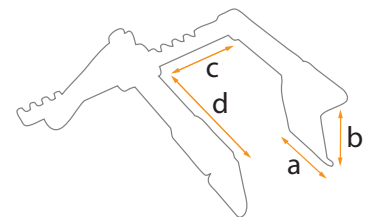



# Retractor Key Handle

## Poignée pour Écarteur



1/1

For Carpentier / Dubost / Finochietto / IMA / Mathey Retractors  
Pour Écarteurs Carpentier / Dubost / Finochietto / IMA / Mathey



Key Screw  
Vis



DC32811-00

Key Pinion  
Pignon



DC32812-08

Step / Pas : 8 mm

DC32812-09

Step / Pas : 9 mm

Key Handle  
Poignée



DC32810-00

Complete Key  
Poignée complète



DC32800-08

Step / Pas : 8 mm

DC32800-09

Step / Pas : 9 mm

# Direct Vision Intercostal Retractor

## Écarteur Intercostal Direct Vision

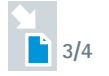

3/4

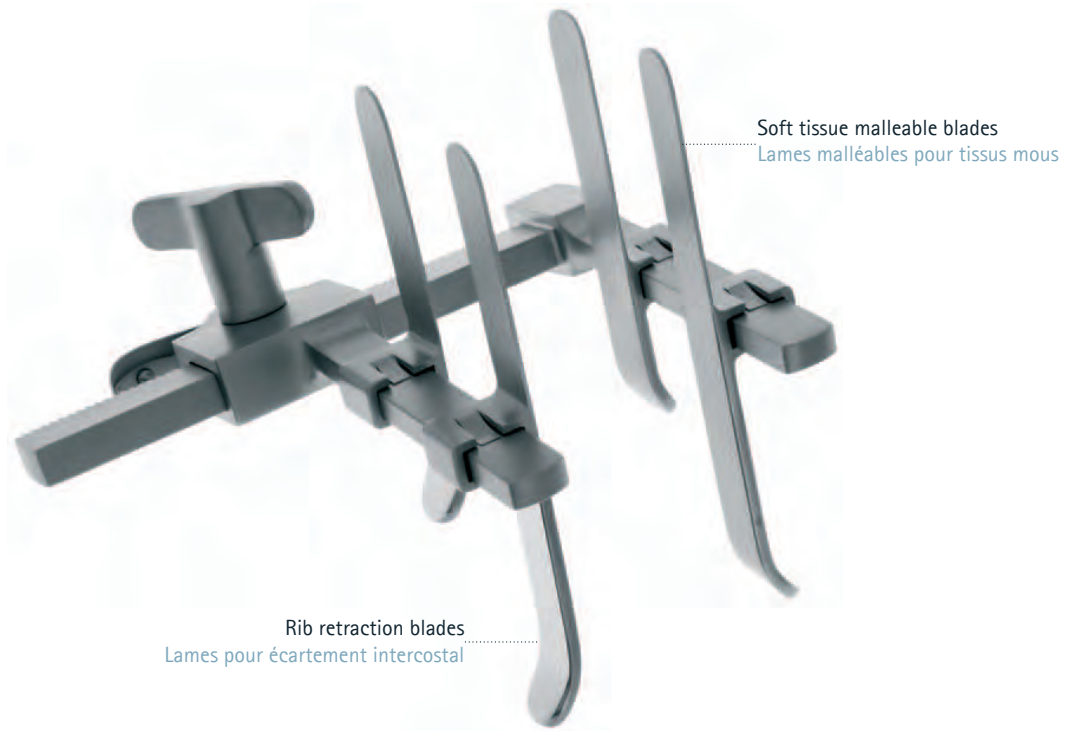

**DC30800-00**

a : 11 mm - c max : 90 mm - d : 80 mm

Included / Inclus : DC30810-25 (pair / paire)  
DC30813-55 (pair / paire)

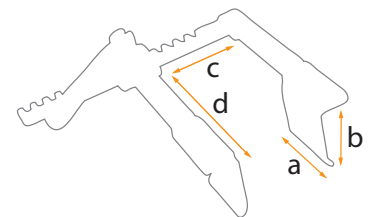

# Direct Vision Intercostal Retractor Blades

## Lames pour Écarteur Intercostal Direct Vision



Semi-Malleable Blades  
Lames Semi-Malléables



**DC30810-25**

a : 11 mm - b : 25 mm



**DC30811-35**

a : 11 mm - b : 35 mm



**DC30812-45**

a : 11 mm - b : 45 mm



**DC30813-55**

a : 11 mm - b : 55 mm

# Tuffier Intercostal Retractor

## Écarteur Intercostal Tuffier

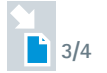

### DC30900-20

a : 20 mm - b : 18 mm - c max : 120 mm - d : 80 mm

### DC30900-35

a : 30 mm - b : 26 mm - c max : 135 mm - d : 90 mm

### DC30900-45

a : 45 mm - b : 45 mm - c max : 210 mm - d : 110 mm

### DC30900-55

a : 45 mm - b : 45 mm - c max : 135 mm - d : 105 mm

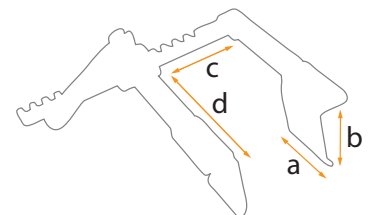

# Morse Favalaro Sternal Retractor

## Écarteur Sternal Morse Favalaro

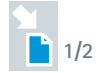

Child / Enfant



**DC31100-20**

a : 20 mm - b : 12 mm - c max : 155 mm - d : 120 mm - Curved Arms / Bras Courbe

**DC31200-01**

a : 20 mm - b : 20 mm - c max : 160 mm - d : 120 mm - Straight Arms / Bras Droit

**DC31200-02**

a : 20 mm - b : 20 mm - c max : 160 mm - d : 120 mm - Curved Arms / Bras Courbe

Adult / Adulte



**DC31100-75**

a : 20 mm - b : 40 mm - c max : 155 mm - d : 175 mm - Curved Arms / Bras Courbe

**DC31200-03**

a : 20 mm - b : 28 mm - c max : 200 mm - d : 150 mm - Straight Arms / Bras Droit

**DC31200-04**

a : 20 mm - b : 28 mm - c max : 200 mm - d : 150 mm - Curved Arms / Bras Courbe

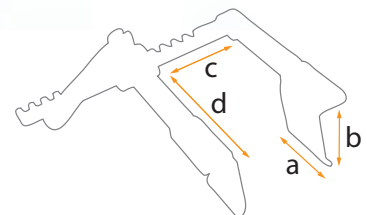

# Cardio System Thoracic Retractor

## Écarteur Thoracique Cardio System

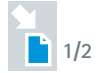

**DC31000-90**

a : 100 mm - b : 30 mm - c max : 190 mm - d : 190 mm

Included / Inclus : DC31020-30 (pair / paire)  
DC31030-00 (pair / paire)

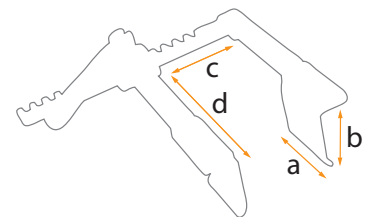

# Cardio System Thoracic Retractor Accessories

## Accessoires pour Écarteur Cardio System

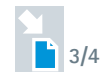

DC31010-30



DC31011-40



DC31020-30



DC31021-40

DC31030-00



**DC31010-30** 4 Blades / 4 Valves

a : 28 mm - b : 30 mm

**DC31011-40** 4 Blades / 4 Valves

a : 28 mm - b : 40 mm

**DC31020-30** Pair / Paire

a : 100 mm - b : 30 mm Cooley

**DC31021-40** Pair / Paire

a : 100 mm - b : 40 mm Cooley

**DC31030-00** Pair / Paire

Inserts - L : 160 mm

# Finochietto Pediatric Retractor

## Écarteur Pédiatrique Finochietto

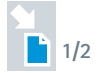

### Neonatal / Nouveau Né

**DC31300-01**

a : 6 mm - b : 7 mm - c max : 36 mm - d : 27 mm



### Infant / Premier Âge

**DC31300-02**

a : 14 mm - b : 14 mm - c max : 80 mm - d : 55 mm



### Baby / Nourrisson

**DC31300-03**

a : 32 mm - b : 30 mm - c max : 100 mm - d : 75 mm

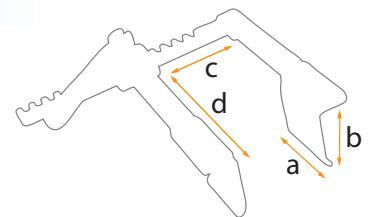



# Finochietto Adult Retractor Écarteur Finochietto Adulte

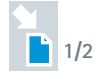

1/2

Adult Small / Adulte, Petit modèle



DC31300-04

a : 45 mm - b : 30 mm - c max : 155 mm - d : 110 mm

Adult Medium / Adulte, Modèle moyen



DC31300-05

a : 62 mm - b : 45 mm - c max : 190 mm - d : 140 mm

Adult Large / Adulte, Grand modèle

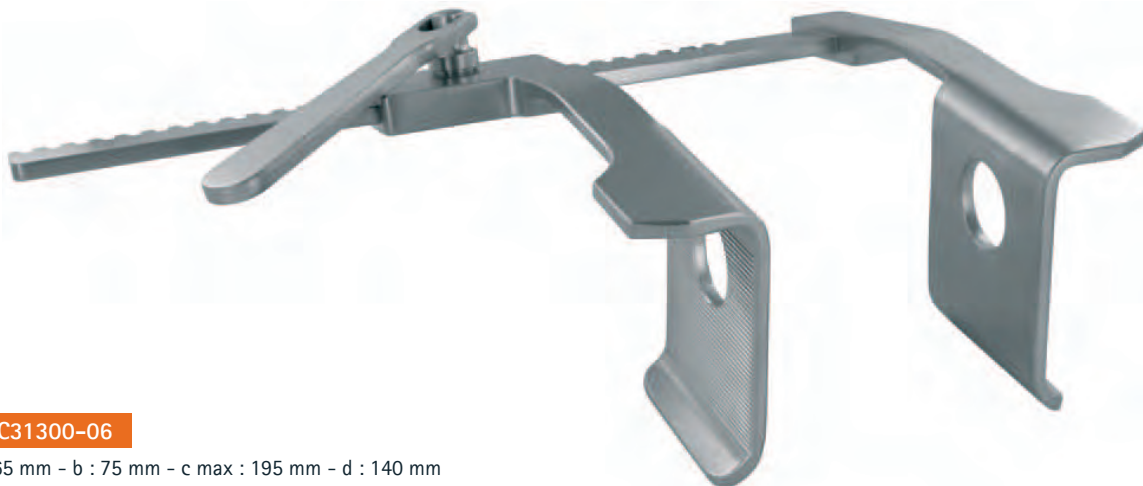

DC31300-06

a : 65 mm - b : 75 mm - c max : 195 mm - d : 140 mm

# Cooley Retractor

## Écarteur Cooley

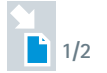

Child / Enfant



DC31650-00

a : 45 mm - b : 24 mm - c max : 155 mm - d : 100 mm

Adult Small / Adulte, Petit modèle

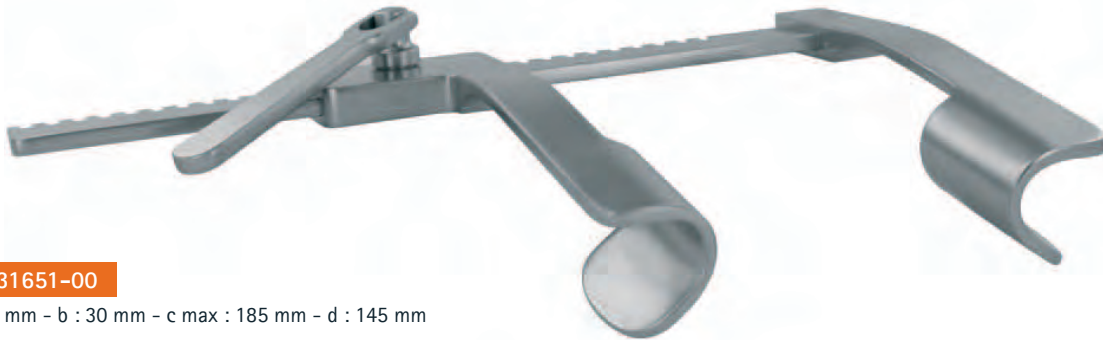

DC31651-00

a : 50 mm - b : 30 mm - c max : 185 mm - d : 145 mm

Adult / Adulte



DC31652-00

a : 105 mm - b : 30 mm - c max : 195 mm - d : 165 mm

Adult Large / Adulte, Grand modèle



DC31653-00

a : 110 mm - b : 32 mm - c max : 230 mm - d : 205 mm

# Cooley Neonatal Retractor

## Écarteur Néonatal Cooley

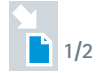

Aluminum  
Aluminium

Neonatal / Nouveau Né



**DC31654-00**

a : 15 mm - b : 9 mm - c max : 72 mm - d : 55 mm

Infant / Premier Âge



**DC31655-00**

a : 15 mm - b : 12 mm - c max : 75 mm - d : 55 mm

Baby / Nourrisson



**DC31656-00**

a : 30 mm - b : 15 mm - c max : 105 mm - d : 80 mm

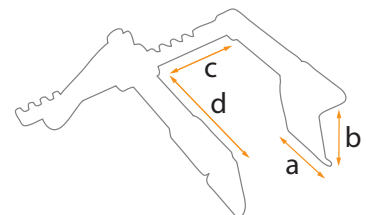

# Cooley Retractor Écarteur Cooley

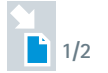

Aluminum  
Aluminium

Child / Enfant



DC31657-00

a : 45 mm - b : 20 mm - c max : 160 mm - d : 100 mm

Adult / Adulte



DC31658-00

a : 100 mm - b : 35 mm - c max : 220 mm - d : 180 mm

Adult Large / Adulte, Grand modèle



DC31659-00

a : 115 mm - b : 35 mm - c max : 230 mm - d : 205 mm



# Burford Adult Retractor

## Écarteur Burford Adulte

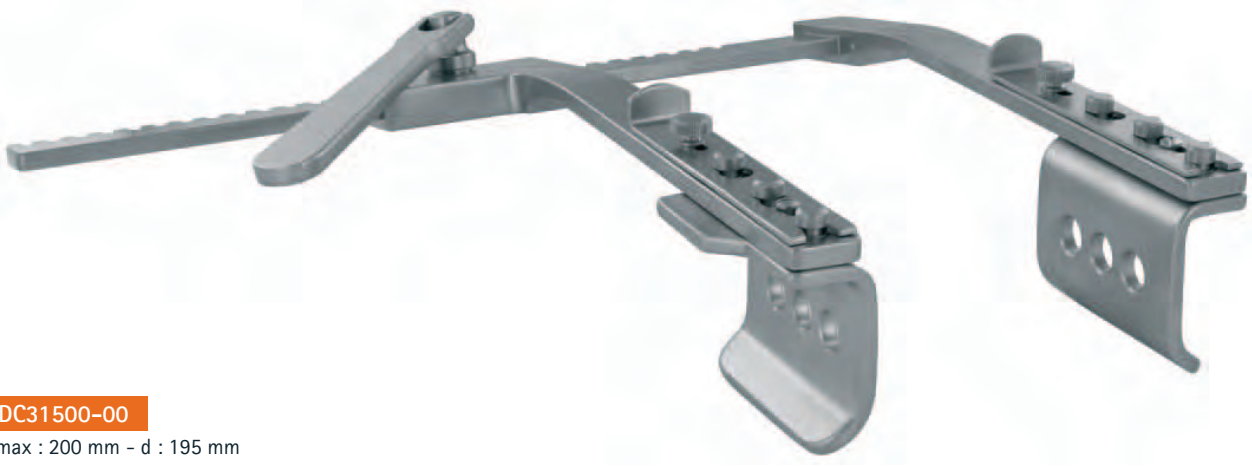
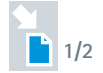

**DC31500-00**

c max : 200 mm - d : 195 mm

Included / Inclus : DC31510-40 (pair / paire)  
DC31511-72 (pair / paire)

**DC31502-00**

c max : 300 mm - d : 195 mm

Included / Inclus : DC31510-40 (pair / paire)  
DC31511-72 (pair / paire)



**DC31510-40** Pair / Paire

a : 65 mm - b : 40 mm



**DC31511-72** Pair / Paire

a : 65 mm - b : 72 mm

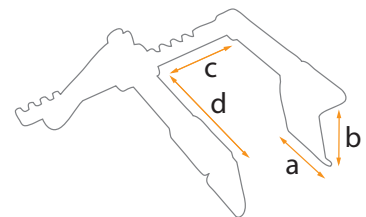

# Burford Adult Retractor

## Écarteur Burford Adulte

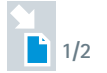

Aluminum  
Aluminium



**DC31600-08**

c max : 250 mm - d : 200 mm

Included / Inclus : DC31610-45 (pair / paire)  
DC31611-65 (pair / paire)

**DC31602-12**

c max : 290 mm - d : 200 mm

Included / Inclus : DC31610-45 (pair / paire)  
DC31611-65 (pair / paire)



**DC31610-45** Pair / Paire

a : 60 mm - b : 45 mm



**DC31611-65** Pair / Paire

a : 60 mm - b : 65 mm

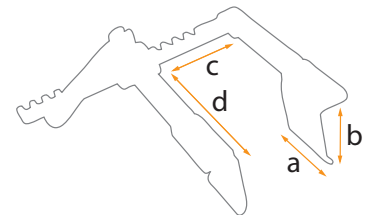

# Ankeney Adult Retractor

## Écarteur Ankeney Adulte

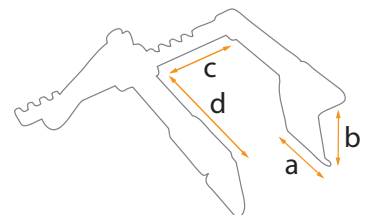
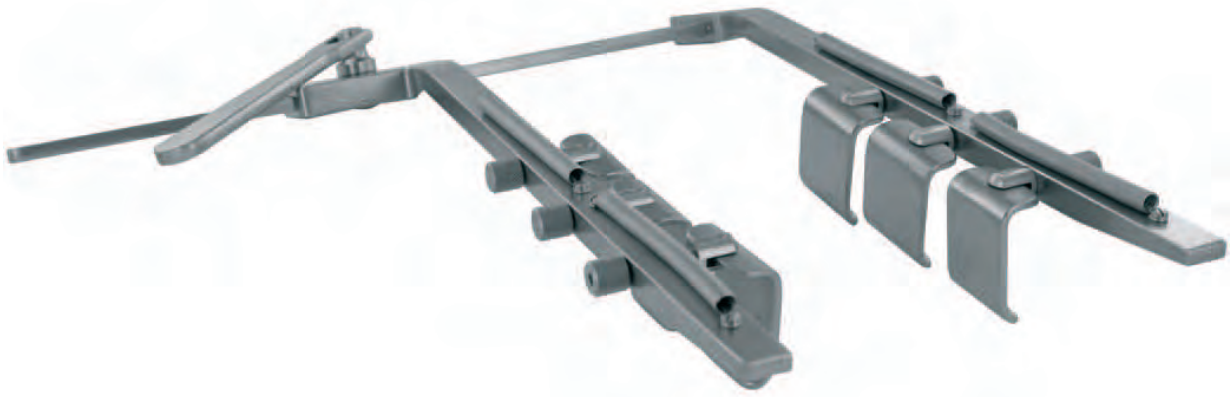
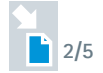

DC31700-00

a : 35 mm - b : 3 x 35 mm - c max : 210 mm - d : 300 mm

# Rib Contractor

## Rapprocheur de Côtes

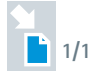

Bailley



**DC33400-00**  
L : 180 mm - 7 "

Sellor

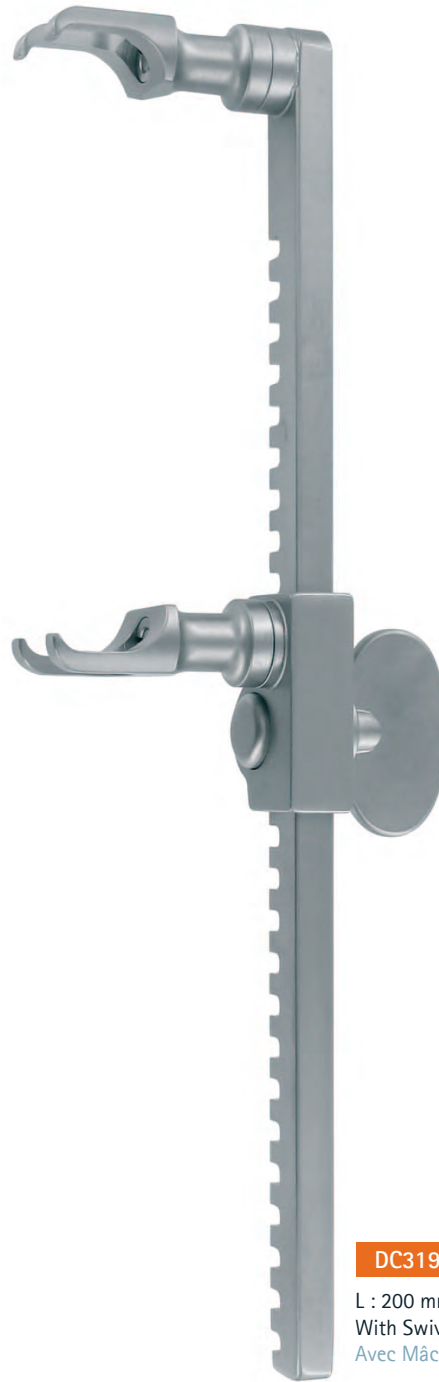

**DC31900-00**  
L : 200 mm - 7 3/4 "  
With Swivel Claws  
Avec Mâchoires Pivotantes



# Rib Contractor

## Rapprocheur de Côtes

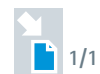

1/1

Gibbon



DC32000-00

L : 165 mm - 6 1/2" - Claws / Mâchoires 45 mm

Kruz



DC32001-00

L : 165 mm - 6 1/2" - Claws / Mâchoires 34 mm

## Articulated-Arms Retractor

## Écarteur à Bras Articulés

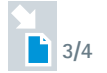

**DC32300-00**

c max : 130 mm - d : 100 mm

Included : 3 pairs of blades / 3 paires de valves incluses

a : 35 mm - b : 35 mm

a : 35 mm - b : 50 mm

a : 35 mm - b : 63 mm

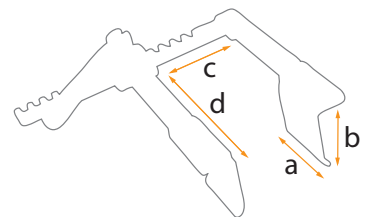

# Scoville Retractor Écarteur Scoville

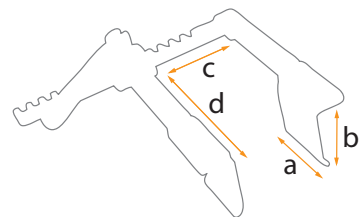

DC32200-00

a : 35 mm - b : 55 mm - c max : 160 mm - d : 130 mm

# Epicardial Retractor

## Écarteur Épicardial

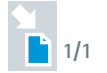

3 x 3 Hooks  
3 x 3 Crochets



**DC32450-25**

L : 30 mm - 1 " - E : 25 mm



**DC32450-28**

L : 35 mm - 1 1/4 " - E : 30 mm



**DC32450-38**

L : 45 mm - 1 1/2 " - E : 35 mm



**DC32450-54**

L : 50 mm - 2 " - E : 40 mm

# Cooley Mitral Retractor

## Écarteur Mitral Cooley

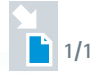

Right / Droite



### DC36800-03

L : 215 mm - W : 25 mm - D : 35 mm - Right / Droite

### DC36800-06

L : 215 mm - W : 40 mm - D : 35 mm - Right / Droite

### DC36800-09

L : 215 mm - W : 50 mm - D : 35 mm - Right / Droite

### DC36800-12

L : 250 mm - W : 50 mm - D : 10 mm - Left / Gauche

# Davidson Lung Spatula

## Spatule Pulmonaire Davidson

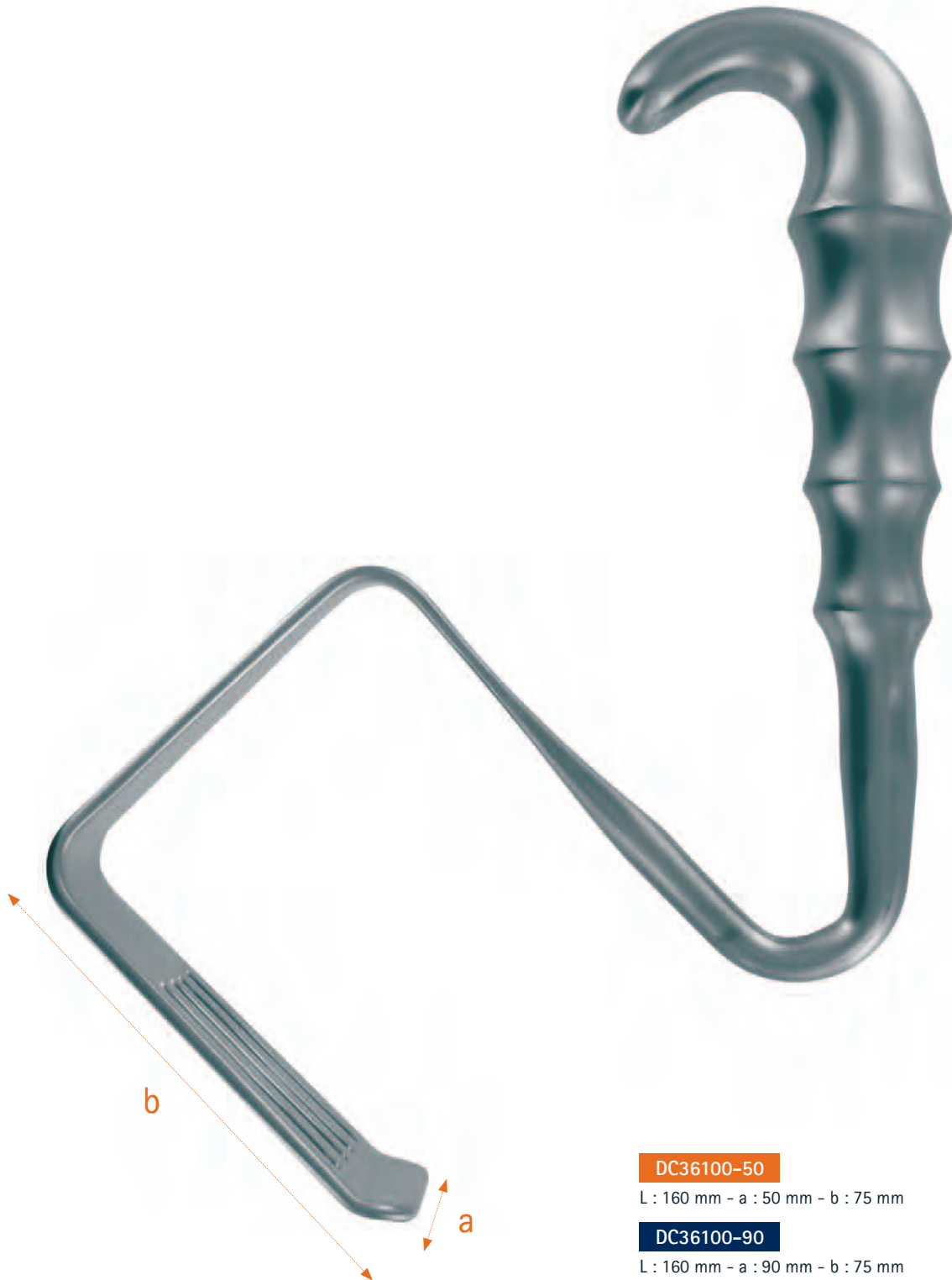
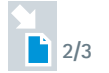

**DC36100-50**

L : 160 mm - a : 50 mm - b : 75 mm

**DC36100-90**

L : 160 mm - a : 90 mm - b : 75 mm

# Alm Retractor Écarteur Alm

Catalogue Landanger  
Chap. VII



Sharp / Pointu



**B802912**

L : 70 mm - 2 3/4 " - Width / Largeur : 6 mm

**B802914**

L : 100 mm - 4 " - Width / Largeur : 6 mm

Blunt / Mousse



**B802913**

L : 70 mm - 2 3/4 " - Width / Largeur : 6 mm

**B802915**

L : 100 mm - 4 " - Width / Largeur : 6 mm

# Beckmann Retractor Écarteur Beckmann

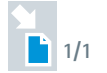

Catalogue Landanger  
Chap. VII



**B80544**

L : 140 mm - 5 1/2 " - Width / Largeur : 8 mm



**B80546**

L : 170 mm - 6 3/4 " - Width / Largeur : 10 mm



**B80551**

L : 210 mm - 8 " - Width / Largeur : 16 mm



# Weitlaner Retractor

## Écarteur Weitlaner

Catalogue Landanger  
Chap. VII

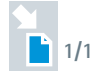

**B80535**

L : 170 mm - 6 <sup>3</sup>/<sub>4</sub> " - Width / Largeur : 16 mm



**B80537**

L : 200 mm - 7 <sup>3</sup>/<sub>4</sub> " - Width / Largeur : 20 mm



**B80538**

L : 170 mm - 6 <sup>3</sup>/<sub>4</sub> " - Width / Largeur : 13 mm  
Curved Shanks / Branches Courbes



**B805410**

L : 200 mm - 7 <sup>3</sup>/<sub>4</sub> " - Width / Largeur : 16 mm  
Curved Shanks / Branches Courbes

# Carpentier Wire Hand Retractor

## Écarteur à Main Carpentier

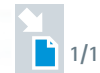
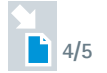

**DC33000-14**

L : 240 mm - 9 1/2 " - Width / Largeur : 14 mm

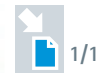

**DC33000-17**

L : 240 mm - 9 1/2 " - Width / Largeur : 17 mm

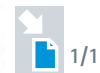

**DC33000-20**

L : 240 mm - 9 1/2 " - Width / Largeur : 20 mm

# Carpentier Hooks

## Crochets Carpentier

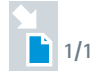

5 mm gauge

**DC33100-00**

L : 240 mm - 9 1/2 " - 90°



**DC33100-28**

L : 280 mm - 1 " - 90°



**DC33100-90**

L : 240 mm - 9 1/2 " - 90°  
With Sabot - Avec Sabot



**DC33110-00**

L : 240 mm - 9 1/2 " - 125°



**DC33110-01**

L : 240 mm - 9 1/2 " - 125°

Extended - Allongé



**DC33120-00**

L : 240 mm - 9 1/2 " - 45°



**DC36400-24**

L : 240 mm - 9 1/2 "

# Hand Retractors Écarteurs à Main



Spatula for Auricula  
Spatule pour Oreillette



DC33200-15

L : 220 mm - 8 1/2 " - W : 15 mm



DC33200-20

L : 220 mm - 8 1/2 " - W : 20 mm

Semb

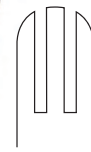

DC33300-03

3 Prongs - 3 Dents

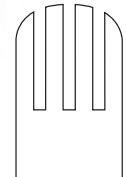
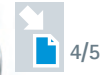

DC33300-04

4 Prongs - 4 Dents

# Chevret Lung Hand Retractor

## Écarteur à Poumon Chevret

Catalogue Landanger  
Chap. VII

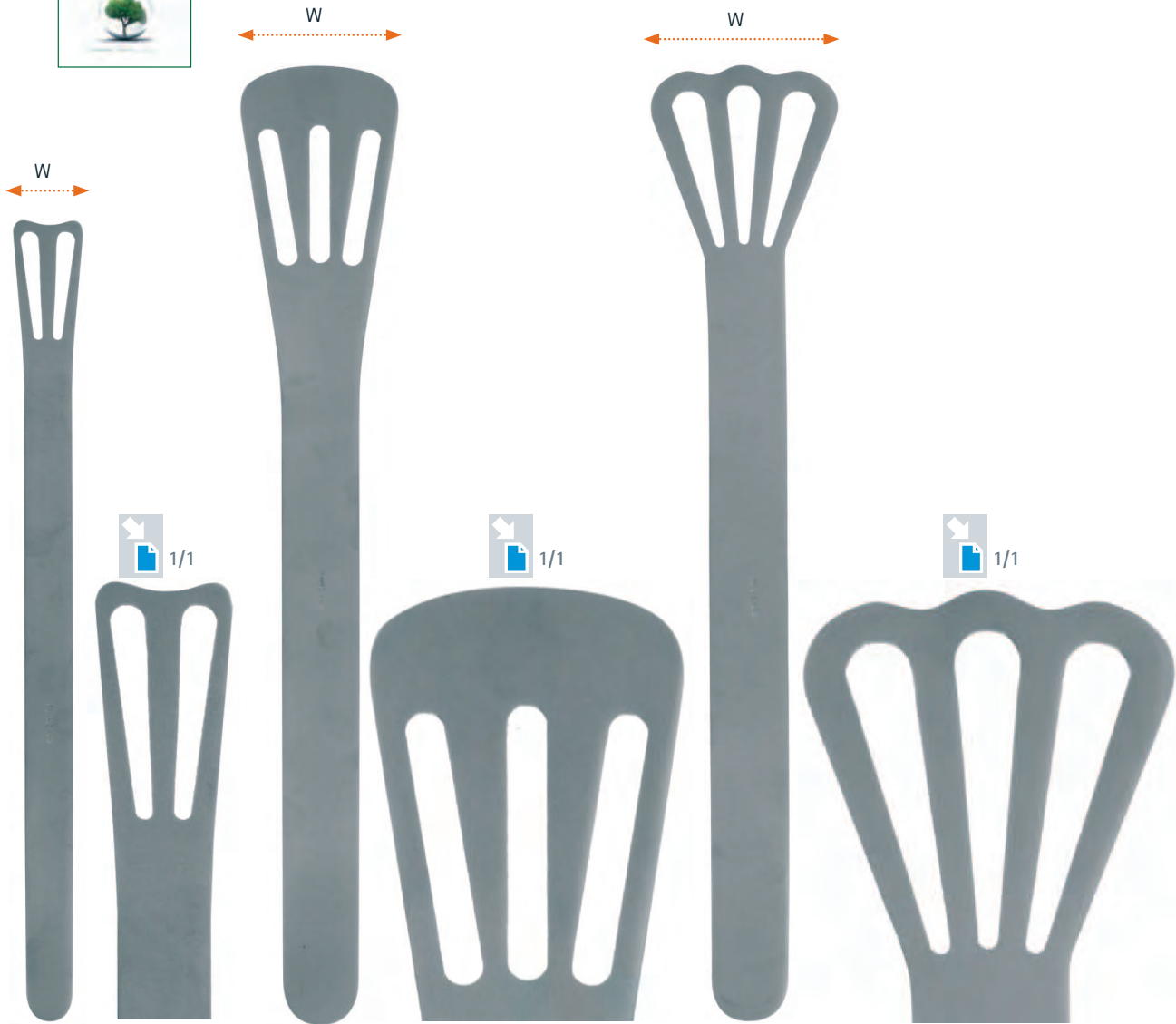
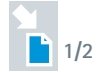

**DC33600-25**

L : 255 mm - 10 " - W : 25 mm

**DC33600-50**

L : 300 mm - 12 " - W : 50 mm

**DC33600-60**

L : 300 mm - 12 " - W : 60 mm

**B80405**

L : 300 mm - 12 " - W : 80 mm

**B80410**

L : 300 mm - 12 " - W : 100 mm

# Lung Spatulae Spatules Pulmonaires

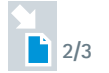

Harrington



**DC35800-40**

A - L : 320 mm - 13 "  
Width / Largeur : 40 mm  
Depth / Profondeur : 127 mm

**DC35800-62**

B - L : 320 mm - 13 "  
Width / Largeur : 62 mm  
Depth / Profondeur : 127 mm



**DC35801-40**

A - L : 320 mm - 13 "  
Width / Largeur : 40 mm  
Depth / Profondeur : 127 mm  
Silicone Handle / Manche Silicone

**DC35801-62**

B - L : 320 mm - 13 "  
Width / Largeur : 62 mm  
Depth / Profondeur : 127 mm  
Silicone Handle / Manche Silicone



**DC36200-30**

L : 300 mm - 12 "

# Lardenois Malleable Blades

## Lames Malléables Lardenois

Catalogue Landanger  
Chap. VII

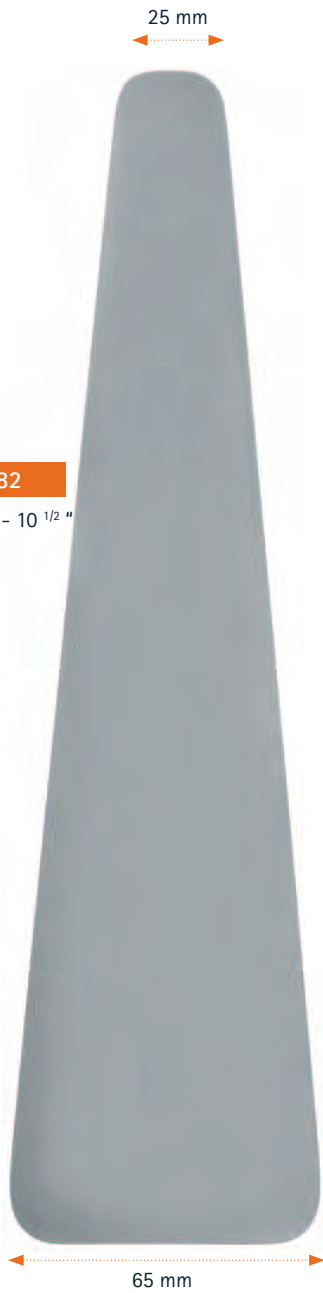
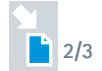

**B80382**

L : 270 mm - 10 1/2 "



**B803934**

L : 330 mm - 13 "



**B80385**

L : 360 mm - 14 "

# Gill-Vernet Rigid Vessel and Wound Hand Retractor

## Écarteur à Main Gill-Vernet

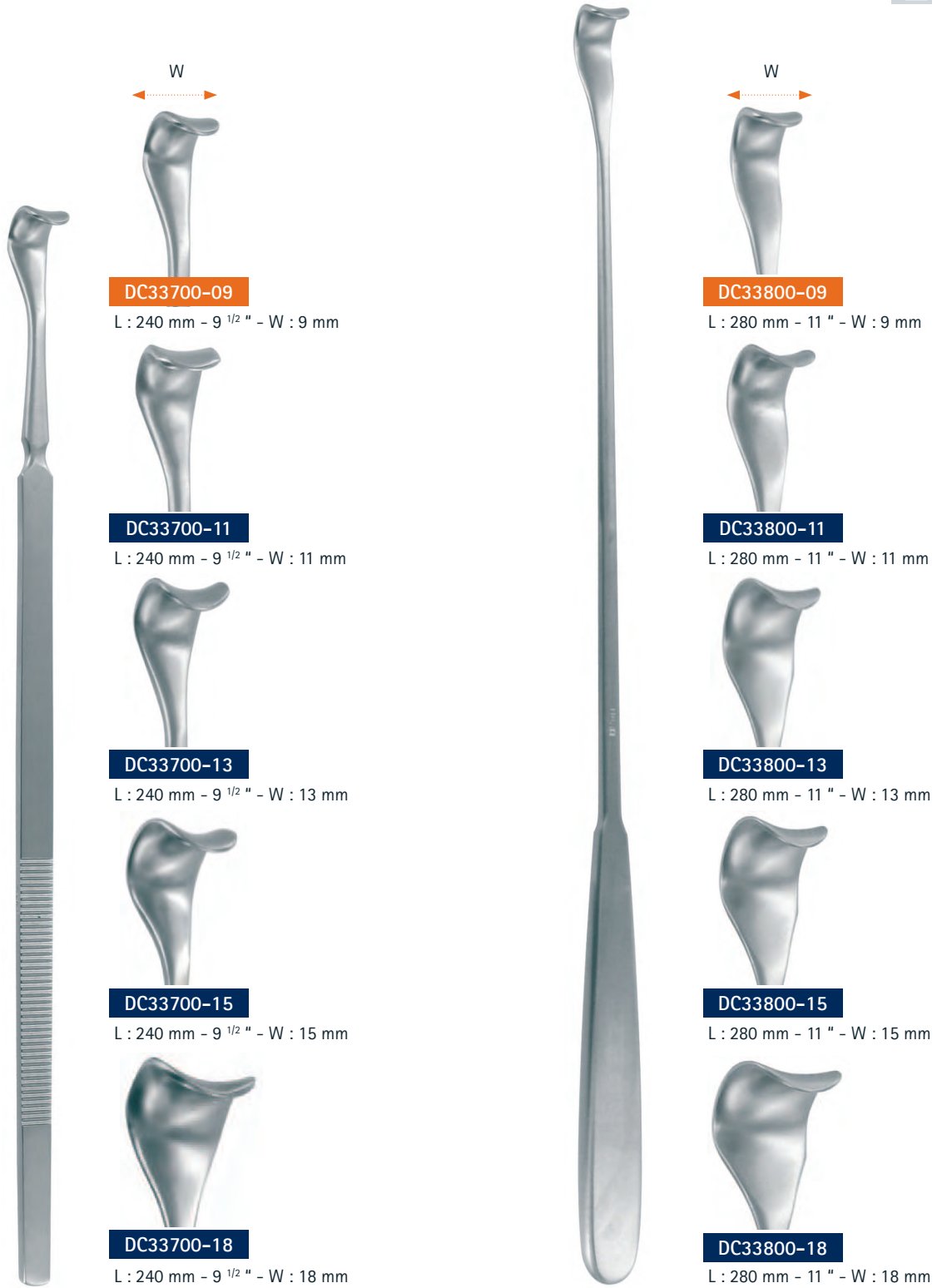
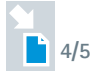



# Desmarres Rigid Vessel and Wound Hand Retractor

## Écarteur à Main Desmarres

Catalogue Landanger  
Chap. VII



**B80301**

L : 150 mm - 6" - W : 6 mm



**B80302**

L : 150 mm - 6" - W : 8 mm



**B80303**

L : 150 mm - 6" - W : 10 mm



**B80304**

L : 150 mm - 6" - W : 12 mm



**B80306**

L : 150 mm - 6" - W : 15 mm



4/5



**DC34000-14**

L : 250 mm - 10" - W : 14 mm



**DC34000-18**

L : 250 mm - 10" - W : 18 mm



**DC34000-22**

L : 250 mm - 10" - W : 22 mm

# Spatula, Hook and Dissector

## Spatule, Crochet et Dissecteur

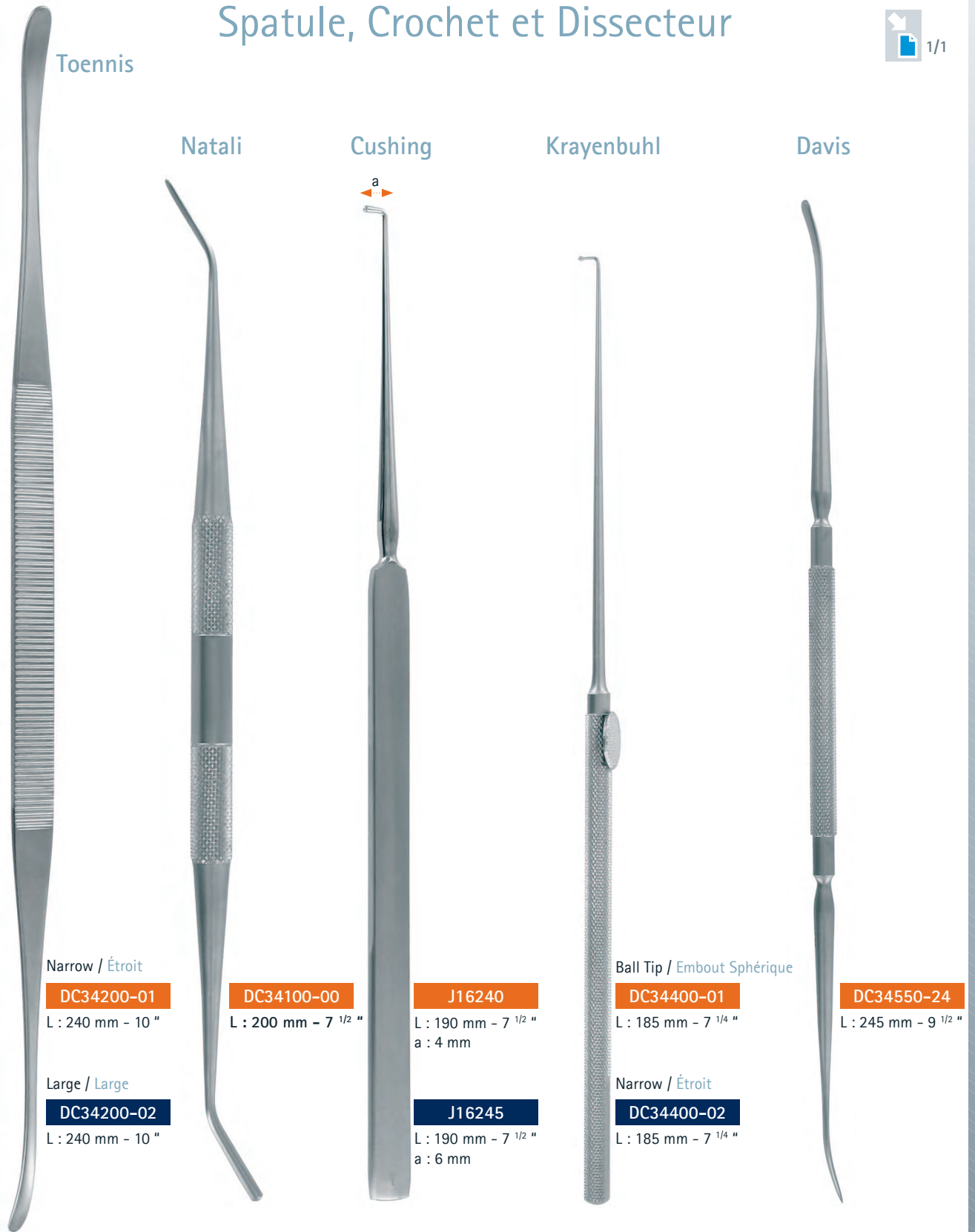
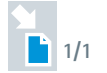

Toennis

Natali

Cushing

Krayenbuhl

Davis

Narrow / Étroit

**DC34200-01**

L : 240 mm - 10 "

Large / Large

**DC34200-02**

L : 240 mm - 10 "

**DC34100-00**

L : 200 mm - 7 1/2 "

**J16240**

L : 190 mm - 7 1/2 "  
a : 4 mm

**J16245**

L : 190 mm - 7 1/2 "  
a : 6 mm

Ball Tip / Embout Sphérique

**DC34400-01**

L : 185 mm - 7 1/4 "

Narrow / Étroit

**DC34400-02**

L : 185 mm - 7 1/4 "

**DC34550-24**

L : 245 mm - 9 1/2 "

# Mitral Hooks

## Crochets Mitrals

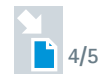

One semi sharp hook  
Crochet semi-pointu

**DC38000-27**

L : 270 mm - 11 "



Two semi sharp hooks  
Deux crochets semi-pointus

**DC38001-27**

L : 270 mm - 11 "

# Dubost Hand Retractor

## Écarteur à Main Dubost

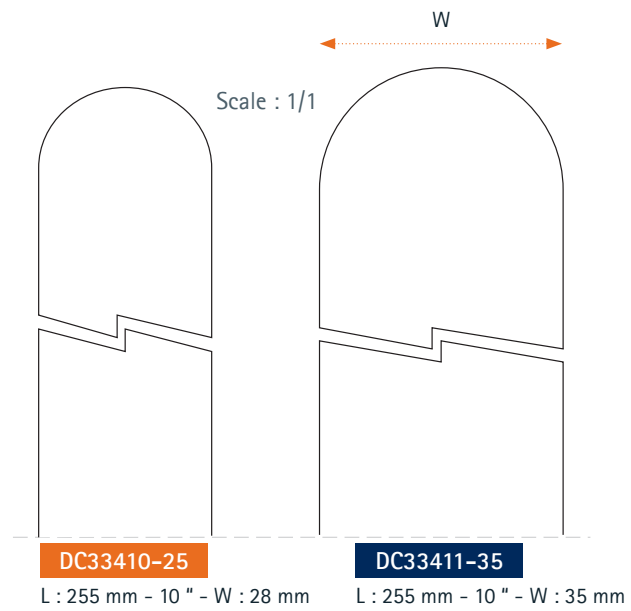
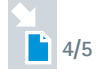

# Kocher-Langenbeck Hand Retractor

## Écarteur à Main Kocher-Langenbeck

Catalogue Landanger  
Chap. VII

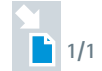

**B802885**

L : 215 mm - 8 1/2 " - Width / Largeur : 6 mm - D : 25 mm

**B802886**

L : 215 mm - 8 1/2 " - Width / Largeur : 8 mm - D : 25 mm

**B802887**

L : 215 mm - 8 1/2 " - Width / Largeur : 8 mm - D : 35 mm

**B802888**

L : 215 mm - 8 1/2 " - Width / Largeur : 11 mm - D : 35 mm

**B802889**

L : 215 mm - 8 1/2 " - Width / Largeur : 15 mm - D : 35 mm

**B802890**

L : 215 mm - 8 1/2 " - Width / Largeur : 11 mm - D : 42 mm

**B802891**

L : 215 mm - 8 1/2 " - Width / Largeur : 11 mm - D : 55 mm

**B802892**

L : 215 mm - 8 1/2 " - Width / Largeur : 14 mm - D : 70 mm

**B802893**

L : 215 mm - 8 1/2 " - Width / Largeur : 12 mm - D : 80 mm

**B802894**

L : 215 mm - 8 1/2 " - Width / Largeur : 16 mm - D : 80 mm

# Hand Retractor Écarteur à Main

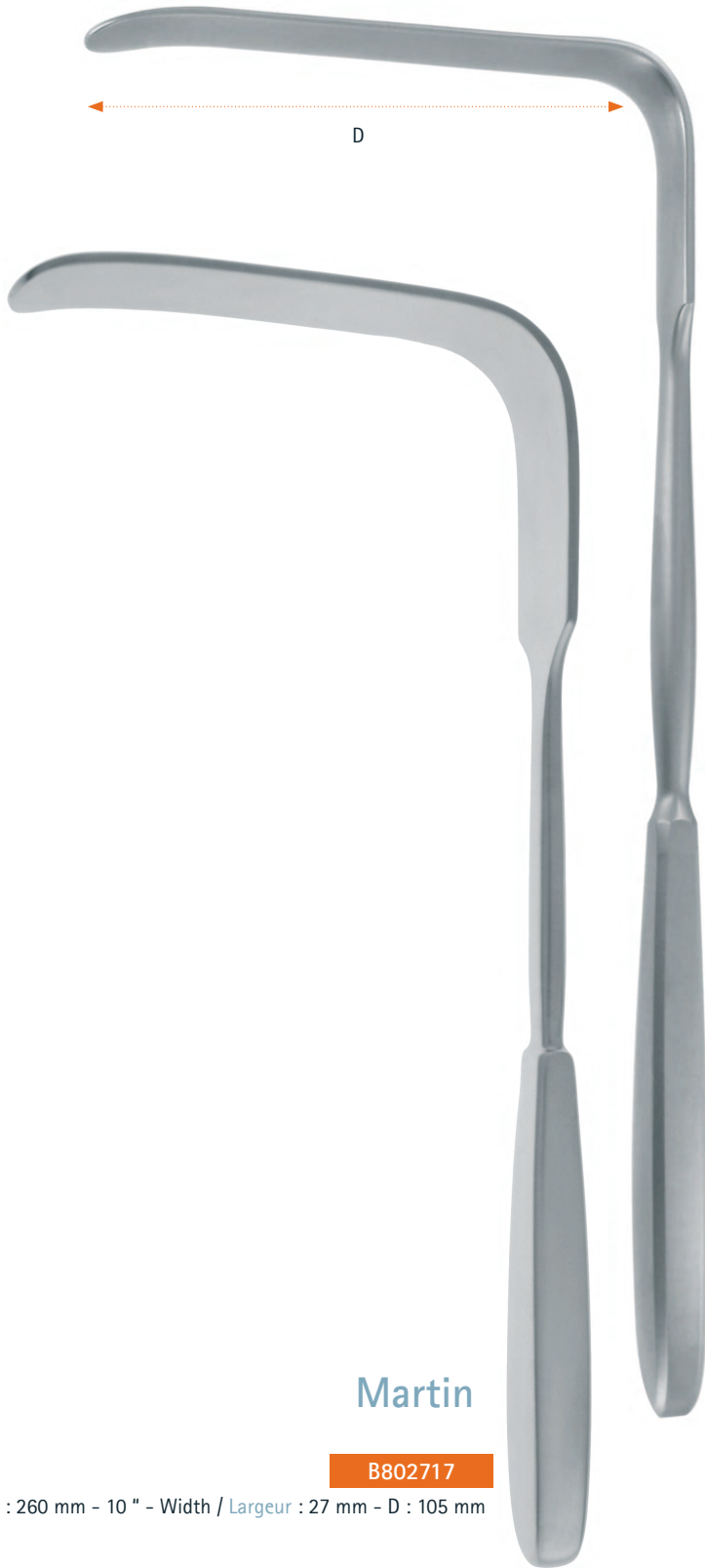
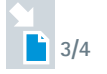

Martin

B802717

L : 260 mm - 10 " - Width / Largeur : 27 mm - D : 105 mm

Simon

B802715

L : 280 mm - 11 " - Width / Largeur : 22 mm - D : 115 mm

B802716

L : 280 mm - 11 " - Width / Largeur : 27 mm - D : 115 mm

# Allison Hand Retractor

## Écarteur à Main Allison

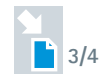

DC35400-25  
L : 255 mm - 10"



DC35400-30  
L : 300 mm - 12 "

## Deaver Lung Spatula Spatule à Poumon Deaver

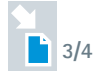

**DC35600-25**

L : 300 mm - 12 " - Depth / Profondeur : 25 mm

**DC35600-38**

L : 300 mm - 12 " - Depth / Profondeur : 38 mm

**DC35600-50**

L : 300 mm - 12 " - Depth / Profondeur : 50 mm

**DC35600-75**

L : 300 mm - 12 " - Depth / Profondeur : 75 mm



# Bloch Homograft Hand Retractor

## Écarteur à Main Bloch

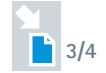

**DC36300-14**

L : 215 mm - 8 1/2 "

Width / Largeur : 14 mm

**DC36300-16**

L : 215 mm - 8 1/2 "

Width / Largeur : 16 mm

**DC36300-18**

L : 215 mm - 8 1/2 "

Width / Largeur : 18 mm



# Clamps

## Clamps



### Specific Cardiac Clamps - *Clamps Cardiaques Spécifiques*

**Carpentier**    **DeBakey**



P 5

P 6

### Aortic Clamps - *Clamps Aortiques*

**DeBakey**    **Cooley**    **DeBakey-Bahnsen**    **Weber**    **Liddle**    **Kay-Lambert**    **DeBakey**    **Beck**



P 7 - P 8

P 9 - P 10

P 11

P 12

P 13

P 14

P 15

P 16

**Cooley**    **Diethrich**    **Ochsner**



P 17

P 18

P 19

### Special Aortic Clamps - *Clamps Aortiques Spéciaux*

**Zangler**    **Wylie**    **Cherry**    **Morris**    **Lemole**



P 20

P 21

P 22

P 23

P 24



# Clamps

## Clamps

### Vena Cava Clamps - *Clamps pour Veine Cave*

Satinsky



P 25

Cooley



P 26



P 27

### Major Arteries Clamps - *Clamps pour Gros Vaisseaux*

Javid



P 28

Henly



P 29

Cooley



P 30



P 31

Renal  
Rénal



P 32

### Peripheral Vascular Clamps - *Clamps pour Chirurgie Vasculaire Périphérique*

DeBakey



P 33

DeBakey Bainbridge



P 34

Pean



Leland-Jones



Potts



DeBakey



Cooley



1

Glover



P 42

Wylie



P 43

Dale



P 44

Derra



P 45



P 46

Cooley



P 47

Parry



P 48

Gregory



P 49

### Bronchus Clamps - *Clamps à Bronches*

Lees



P 50

Price Thomas



P 51

Mathey



P 51

### Intestinal Clamps - *Clamps Intestinaux*

Kocher



P 52

Mayo-Robson



P 53

Doyen



P 54

Baby-Doyen



P 55

Scheibe



P 56

Subramanian



P 57

Hayes



P 58

# Clamps

## Clamps



### Multipurpose Clamps - *Clamps Multifonctions*

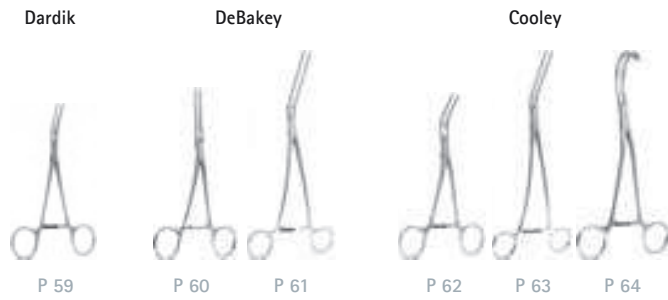

### Ligature Carrier Clamps - *Clamps Passe-Fil*

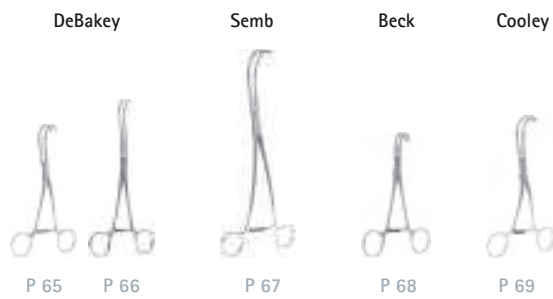

### Dissectors - *Dissecteurs*

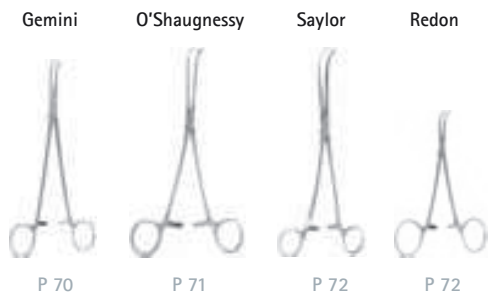

### Ring Handle Bulldog Clamps - *Clamps Bulldog à Anneaux*

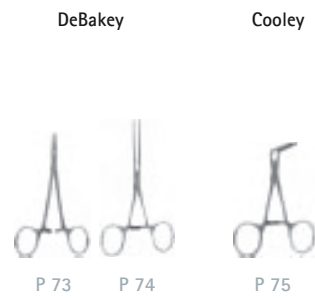

### Bulldog Clamps - *Clamps Bulldog*





# Clamps Clamps

## Bulldog Clamps - *Clamps Bulldog*

Glover

DeBakey

Mini-Glover



## Pediatric Clamps - *Clamps Pédiatriques*

DeBakey

Glover

Cooley

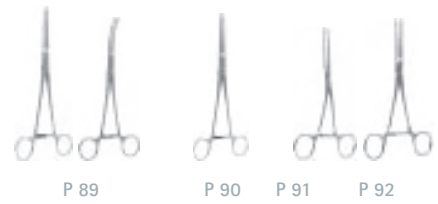

## Delicate Clamps - *Clamps Délicats*

DeBakey

Castaneda

Cooley

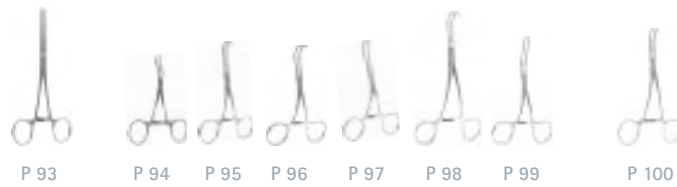

## Haemostatic Forceps - *Pinces Hémostatiques*

Kocher

Kelly

Crille

Christophe

Leriche

Halstead

Bengolea

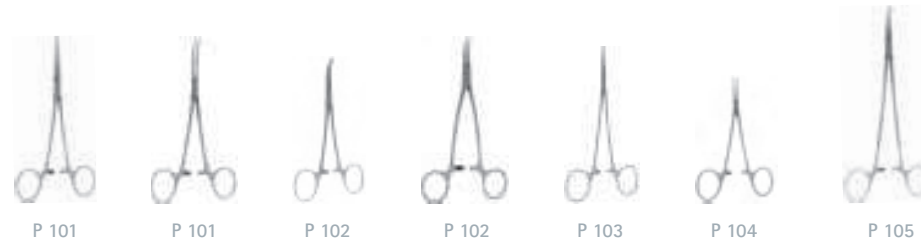

## Grasping Forceps - *Pinces à Préhension*

Babcock

Duval

Allis

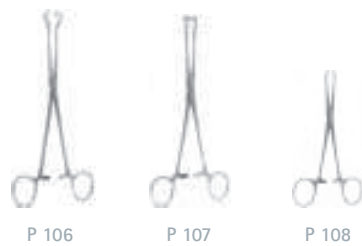

# Carpentier Papillary Muscles Clamp

## Clamp Carpentier pour Muscles Papillaires

No Scale - Pas d'Échelle

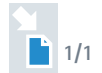

Resano Jaws  
Mors Resano



**DC45000-19**

L : 190 mm - 7 1/2 "

**DC45000-25**

L : 250 mm - 9 4/5 "

**DC45000-29**

L : 290 mm - 11 2/5 "

No Scale - Pas d'Échelle



**DC45001-25**

L : 250 mm - 9 4/5 "





# DeBakey Harken Auricle Clamp

## Clamp Harken DeBakey pour Oreillette

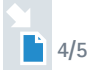

Scale - Échelle : 1/1

**DC40250-25**  
L : 250 mm - 9 <sup>4</sup>/<sub>5</sub> "

**DC40251-24**  
L : 240 mm - 9 <sup>1</sup>/<sub>2</sub> "

**DC40252-25**  
L : 250 mm - 9 <sup>4</sup>/<sub>5</sub> "

**DC40253-24**  
L : 240 mm - 9 <sup>1</sup>/<sub>2</sub> "



# DeBakey Aortic Clamp

## Clamp Aortique DeBakey



No Scale - Pas d'Échelle

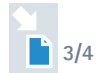

**DC40280-16**

L : 160 mm - 6 1/3 "

Scale - Échelle : 1/1



**DC40280-26**

L : 265 mm - 10 2/5 "



**DC40281-31**

L : 300 mm - 12 1/5 "

# DeBakey Aortic Aneurysm Clamp

## Clamp DeBakey Pour Anévrisme Aortique

No Scale - Pas d'Échelle

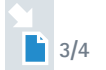

3/4

Scale - Échelle : 1/1



DeBakey  
Jaws

**DC40081-24**

L : 240 mm - 9 1/2 "



DeBakey  
Jaws

**DC40082-27**

L : 270 mm - 10 2/3 "

Scale - Échelle : 1/1



DeBakey  
Jaws

**DC40083-31**

L : 310 mm - 12 1/5 "



DeBakey  
Jaws

**DC40084-32**

L : 325 mm - 12 4/5 "

# Cooley Aortic Clamp

## Clamp Aortique Cooley

No Scale - Pas d'Échelle

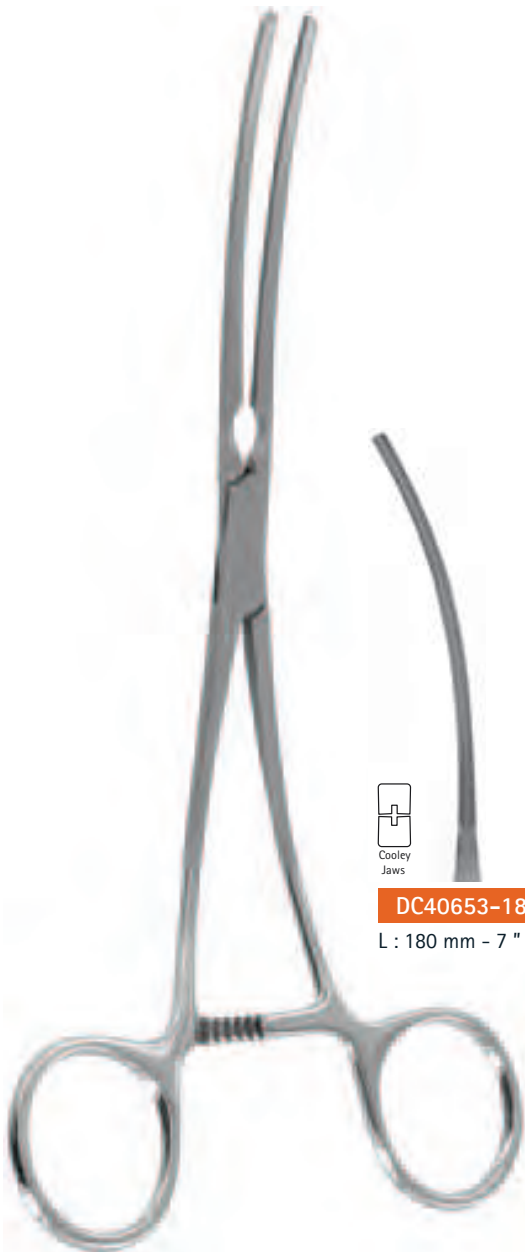

Cooley  
Jaws

**DC40653-18**

L : 180 mm - 7 "



Cooley  
Jaws

**DC40654-27**

L : 270 mm - 10 <sup>2</sup>/<sub>3</sub> "



Cooley  
Jaws

**DC40655-33**

L : 325 mm - 12 <sup>4</sup>/<sub>5</sub> "

# Cooley Aortic Clamp Clamp Aortique Cooley



No Scale - Pas d'Échelle

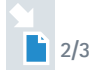

Scale - Échelle : 1/1

DC40652-31

L : 320 mm - 12 1/2 "

# DeBakey Bahnson Aortic Aneurysm Clamp

## Clamp Aortique Bahnson DeBakey



No Scale - Pas d'Échelle

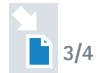

**DC40210-24**  
L : 235 mm - 9 <sup>1</sup>/<sub>4</sub> "

Scale - Échelle : 1/1



**DC40210-25**  
L : 250 mm - 9 <sup>4</sup>/<sub>5</sub> "

**DC40210-27**  
L : 265 mm - 10 <sup>2</sup>/<sub>5</sub> "

# Weber Aortic Clamp Clamp Aortique Weber



No Scale - Pas d'Échelle

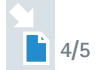

Right

Scale - Échelle : 1/1

DC40510-26

L : 260 mm - 10 1/5 "

Scale - Échelle : 1/1

Left

DC40511-26

L : 260 mm - 10 1/5 "

# Liddle Aortic Clamp

## Clamp Aortique Liddle



No Scale - Pas d'Échelle



Scale - Échelle : 1/1

DC40460-25

L : 255 mm - 10 "

# Kay Lambert Aortic Clamp

## Clamp Aortique Kay Lambert



No Scale - Pas d'Échelle

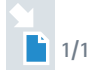

DC40410-20

L : 200 mm - 7 4/5 "



DC40411-20

L : 200 mm - 7 4/5 "





# DeBakey Aortic Clamp

## Clamp Aortique DeBakey



No Scale - Pas d'Échelle

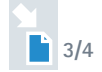

Scale - Échelle : 1/1

DC40080-26

L : 265 mm - 10 1/2 "

# Beck Aortic Clamp Clamp Aortique Beck

No Scale - Pas d'Échelle

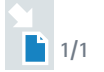

	 DeBaKEY Jaws		 Cooley Jaws	
	<b>DC40230-16</b>	<b>DC40628-17</b>		
	L : 165 mm - 6 <sup>1</sup> / <sub>2</sub> "	L : 170 mm - 6 <sup>2</sup> / <sub>3</sub> "		
	 DeBaKEY Jaws		<b>DC40231-20</b>	L : 200 mm - 7 <sup>4</sup> / <sub>5</sub> "
 DeBaKEY Jaws		<b>DC40232-19</b>	L : 195 mm - 7 <sup>2</sup> / <sub>3</sub> "	

# Cooley Aortic Clamp

## Clamp Aortique Cooley



No Scale - Pas d'Échelle

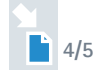

Scale - Échelle : 1/1

**DC40660-22**

L : 225 mm - 8 <sup>4</sup>/<sub>5</sub> "

**DC40661-27**

L : 265 mm - 10 <sup>2</sup>/<sub>5</sub> "

**DC40662-26**

L : 260 mm - 10 <sup>1</sup>/<sub>5</sub> "



**DC40663-20**

L : 200 mm - 7 <sup>4</sup>/<sub>5</sub> "

**DC40664-25**

L : 255 mm - 10 "

**DC40665-27**

L : 270 mm - 10 <sup>2</sup>/<sub>3</sub> "

# Diethrich Aortic Clamp Clamp Aortique Diethrich



No Scale - Pas d'Échelle

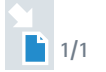

1/1



DC40330-22

L : 200 mm - 7 <sup>4</sup>/<sub>5</sub> "

# Ochsner Aortic Clamp

## Clamp Aortique Ochsner



No Scale - Pas d'Échelle

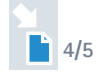

Scale - Échelle : 1/1

DC40480-26

L : 260 mm - 10 1/5 "

# Zangler Abdominal Aorta Clamp

## Clamp Zangler pour Aorte Abdominale

No Scale - Pas d'Échelle

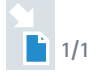

DeBakey  
Jaws

**DC40540-21**

L : 215 mm - 8 1/2 "

**DC40541-25**

L : 235 mm - 9 2/5 "



DeBakey  
Jaws

**DC40542-30**

L : 300 mm - 11 4/5 "

# Wylie Hypogastric and Abdominal Aorta Clamp

## Clamp Wylie pour Aorte Abdominale



No Scale - Pas d'Échelle

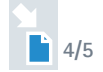

Scale - Échelle : 1/1

DC40530-26

L : 260 mm - 10 <sup>1</sup>/<sub>5</sub> "

# Cherry Supraceliac Clamp

## Clamp Cherry pour Aorte Supracœliaque

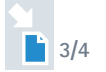

DC40300-31

L : 315 mm - 12 <sup>2</sup>/<sub>5</sub> "



# DeBakey Morris Aortic Clamp

## Clamp Aortique Morris DeBakey



No Scale - Pas d'Échelle

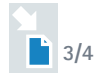

Scale - Échelle : 1/1

**DC40255-26**   
L : 265 mm - 10 <sup>2</sup>/<sub>5</sub> "



No Scale - Pas d'Échelle

Scale - Échelle : 1/1

**DC40256-22**  
L : 225 mm - 8 <sup>4</sup>/<sub>5</sub> "



Scale - Échelle : 1/1

**DC40257-27**  
L : 270 mm - 10 <sup>2</sup>/<sub>3</sub> "



# Lemole Aortic Clamp Clamp Aortique Lemole

No Scale - Pas d'Échelle

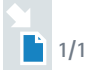

**DC40440-20**

L : 205 mm - 8 "

Width / Largeur : 16 mm - Depth / Profondeur : 41 mm

**DC40441-20**

L : 205 mm - 8 "

Width / Largeur : 23 mm - Depth / Profondeur : 45 mm

# DeBakey Satinsky Vena Cava Clamp

## Clamp Satinsky DeBakey



No Scale - Pas d'Échelle

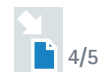

Scale - Échelle : 1/1



**DC40260-20**

L : 200 mm - 7 <sup>4</sup>/<sub>5</sub> "

**DC40261-25**

L : 245 mm - 9 <sup>2</sup>/<sub>3</sub> "



Scale - Échelle : 1/1

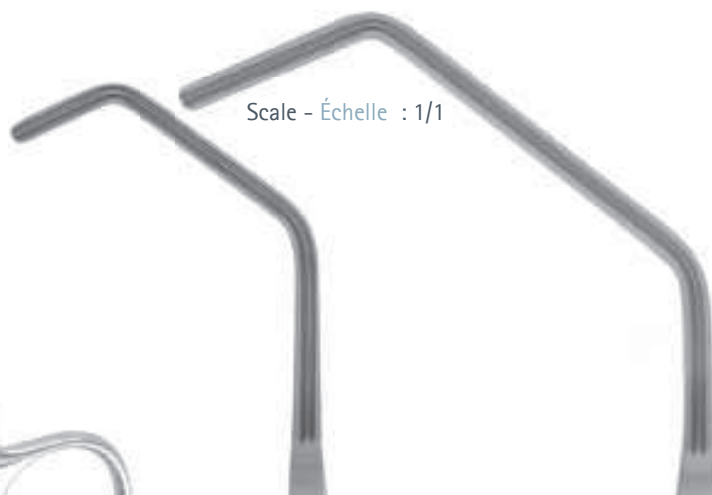

**DC40262-26**

L : 260 mm - 10 <sup>1</sup>/<sub>5</sub> "

**DC40265-24**

L : 240 mm - 9 <sup>1</sup>/<sub>2</sub> "

**DC40264-27**

L : 270 mm - 10 <sup>2</sup>/<sub>3</sub> "

**DC40263-26**

L : 265 mm - 10 <sup>2</sup>/<sub>5</sub> "

# Cooley Tangential Occlusion Clamp

## Clamp Cooley pour Occlusion Tangentielle



No Scale - Pas d'Échelle

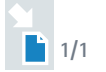

**DC40670-20**  
L : 195 mm - 7 <sup>2</sup>/<sub>3</sub> "

**DC40671-25**  
L : 250 mm - 9 <sup>4</sup>/<sub>5</sub> "

**DC40672-26**  
L : 260 mm - 10 <sup>1</sup>/<sub>5</sub> "

**DC40673-26**  
L : 265 mm - 10 <sup>2</sup>/<sub>5</sub> "

**DC40674-27**  
L : 270 mm - 10 <sup>2</sup>/<sub>3</sub> "

# Cooley Caval Occlusion Clamp

## Clamp Cooley pour Occlusion de la Veine Cave



**DC40730-20**   
L : 210 mm - 8 <sup>1</sup>/<sub>3</sub> " - Ø : 20 FR

**DC40730-24**   
L : 160 mm - 6 <sup>1</sup>/<sub>3</sub> " - Ø : 24 FR

**DC40730-26**   
L : 185 mm - 7 <sup>1</sup>/<sub>3</sub> " - Ø : 26 FR

**DC40730-28**   
L : 190 mm - 7 <sup>1</sup>/<sub>2</sub> " - Ø : 28 FR

**DC40730-30**   
L : 195 mm - 7 <sup>2</sup>/<sub>3</sub> " - Ø : 30 FR

**DC40730-32**   
L : 195 mm - 7 <sup>2</sup>/<sub>3</sub> " - Ø : 32 FR

**DC40730-34**   
L : 195 mm - 7 <sup>2</sup>/<sub>3</sub> " - Ø : 34 FR

**DC40730-36**   
L : 195 mm - 7 <sup>2</sup>/<sub>3</sub> " - Ø : 36 FR

**DC40730-38**   
L : 200 mm - 7 <sup>4</sup>/<sub>5</sub> " - Ø : 38 FR

**DC40730-40**   
L : 210 mm - 8 <sup>1</sup>/<sub>3</sub> " - Ø : 40 FR

# Javid Clamp for Carotid Bypass

## Clamp Javid pour Pontage Carotidien

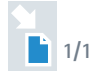

DC46200-16

L : 160 mm - 6 <sup>1</sup>/<sub>3</sub> "



DC46200-19

L : 190 mm - 7 <sup>1</sup>/<sub>2</sub> "

# Henly Subclavian Artery Clamp

## Clamp Henly pour Artère Sous-Clavière



DC40400-20  
L : 200 mm - 7 <sup>4</sup>/<sub>5</sub> "

# Cooley Iliac Clamp

## Clamp Cooley pour Artère Iliaque

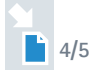

**DC40642-24**

L : 240 mm - 9 1/2 "

**DC40643-27**

L : 275 mm - 10 4/5 "



**DC40640-22**

L : 220 mm - 8 2/3 "



**DC40641-26**

L : 260 mm - 10 1/5 "





# Cooley Clamp Clamp Cooley



Cooley  
Jaws



No Scale - Pas d'Échelle

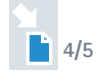

Scale - Échelle : 1/1



**DC40650-28**

L : 270 mm - 10 <sup>2</sup>/<sub>3</sub> "

Scale - Échelle : 1/1



**DC40651-25**

L : 255 mm - 10 "

# Renal Artery Clamp Clamp pour Artère Rénale

No Scale - Pas d'Échelle



1/1

DC40060-20

L : 200 mm - 7 <sup>4</sup>/<sub>5</sub> "



DC40720-18

L : 185 mm - 7 <sup>1</sup>/<sub>3</sub> "



DC40721-19

L : 195 mm - 7 <sup>2</sup>/<sub>3</sub> "



# DeBakey Peripheral Vascular Clamp

## Clamp DeBakey pour Chirurgie Vasculaire Périphérique



No Scale - Pas d'Échelle



Angled Shanks  
Branches Coudées

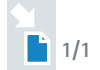

Straight Shanks  
Branches Droites



**DC40040-19**

L : 200 mm - 8 "

**DC40041-22**

L : 220 mm - 8 <sup>2</sup>/<sub>3</sub> "



**DC40042-19**

L : 200 mm - 8 "

**DC40043-22**

L : 215 mm - 8 <sup>1</sup>/<sub>2</sub> "



No Scale - Pas d'Échelle

Curved Shanks  
Branches Courbes



**DC40044-18**

L : 185 mm - 7 <sup>1</sup>/<sub>3</sub> "



**DC40045-26**

L : 265 mm - 10 <sup>2</sup>/<sub>5</sub> "



# DeBakey Bainbridge Vascular Clamp

## Clamp Vasculaire Bainbridge DeBakey

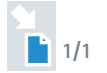

Straight Shanks  
Branches Droites



**DC40220-17**

L : 170 mm - 6 <sup>2</sup>/<sub>3</sub> "



**DC40222-18**

L : 185 mm - 7 <sup>1</sup>/<sub>3</sub> "



**DC40221-16**

L : 160 mm - 6 <sup>1</sup>/<sub>3</sub> "



**DC40223-18**

L : 185 mm - 7 <sup>1</sup>/<sub>3</sub> "

# DeBakey Pean Clamp

## Clamp Pean DeBakey

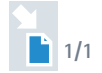

**DC40130-14**

L : 140 mm - 5 1/2 "

**DC40132-18**

L : 180 mm - 7 "

**DC40133-20**

L : 200 mm - 7 4/5 "

**DC40135-28**

L : 280 mm - 11 "

**DC40140-14**

L : 140 mm - 5 1/2 "

**DC40142-18**

L : 180 mm - 7 "

**DC40143-20**

L : 200 mm - 7 4/5 "

**DC40145-28**

L : 280 mm - 11 "

# Leland Jones Vascular Clamp

## Clamp Vasculaire Leland Jones

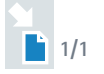

Straight  
Droite



**DC40430-19**  
L : 195 mm - 7 <sup>2</sup>/<sub>3</sub> "

Angled 10°  
Coudé 10°



**DC40431-19**  
L : 190 mm - 7 <sup>1</sup>/<sub>2</sub> "

Angled 30°  
Coudé 30°



**DC40432-19**  
L : 185 mm - 7 <sup>1</sup>/<sub>3</sub> "

Angled 45°  
Coudé 45°



**DC40433-19**  
L : 185 mm - 7 <sup>1</sup>/<sub>3</sub> "

# DeBakey Potts Clamp

## Clamp Potts DeBakey



No Scale - Pas d'Échelle

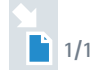

DC40346-21

L : 210 mm - 8 <sup>1</sup>/<sub>3</sub> "

DC40347-22

L : 225 mm - 8 <sup>4</sup>/<sub>5</sub> "

# DeBakey Vascular Clamp

## Clamp Vasculaire DeBakey

No Scale - Pas d'Échelle

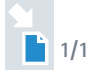

DC40010-16   
L : 160 mm - 6 1/3 "



DC40021-16  
L : 160 mm - 6 1/3 "

DC40020-15  
L : 150 mm - 5 4/5 "



# DeBakey Vascular Clamp

## Clamp Vasculaire DeBakey



No Scale - Pas d'Échelle



DC40090-20 

L : 200 mm - 8"



DC40091-18 

L : 180 mm - 7"

# Cooley Vascular Clamp Clamp Vasculaire Cooley



Cooley  
Jaws



No Scale - Pas d'Échelle

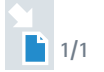

1/1



**DC40610-18**

L : 180 mm - 7 "



**DC40611-16**

L : 160 mm - 6 1/2 "

**DC40612-21**

L : 215 mm - 8 1/2 "

**DC40613-24**

L : 245 mm - 9 1/2 "

# Cooley Vascular Clamp

## Clamp Vasculaire Cooley

No Scale - Pas d'Échelle



**DC40614-18**  
L : 185 mm - 7 <sup>1</sup>/<sub>3</sub> "



**DC40615-16**  
L : 165 mm - 6 <sup>1</sup>/<sub>2</sub> "



**DC40616-17**  
L : 175 mm - 6 <sup>4</sup>/<sub>5</sub> "



**DC40617-19**  
L : 190 mm - 7 <sup>1</sup>/<sub>2</sub> "

# Glover Vascular Clamp Clamp Vasculaire Glover

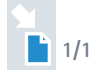

**DC40361-18**  
L : 185 mm - 7 <sup>1</sup>/<sub>3</sub> "



**DC40351-22**  
L : 220 mm - 8 <sup>2</sup>/<sub>3</sub> "



**DC40363-18**  
L : 180 mm - 7 "



**DC40352-22**  
L : 225 mm - 8 <sup>4</sup>/<sub>5</sub> "



**DC40362-26**   
L : 260 mm - 10 <sup>1</sup>/<sub>5</sub> "

# Wylie Vascular Clamp

## Clamp Vasculaire Wylie

4/5



Scale - Échelle : 1/1

DC40520-21  
L : 210 mm - 8 <sup>1</sup>/<sub>3</sub> "



Scale - Échelle : 1/1

DC40521-22  
L : 220 mm - 8 <sup>2</sup>/<sub>3</sub> "

# Dale Peripheral Vascular Clamp

## Clamp Dale pour Chirurgie Vasculaire Périphérique



No Scale - Pas d'Échelle

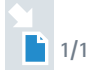

**DC40320-17**

L : 175 mm - 6 <sup>4</sup>/<sub>5</sub> "

**DC40322-18**

L : 180 mm - 7 "

**DC40321-18**

L : 180 mm - 7 "

**DC40323-18**

L : 185 mm - 7 <sup>1</sup>/<sub>3</sub> "

# DeBakey Derra Anastomosis Clamp

## Clamp Derra DeBakey



No Scale - Pas d'Échelle

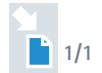

DC40240-17

L : 170 mm - 6 <sup>2</sup>/<sub>3</sub> "

DC40241-17

L : 170 mm - 6 <sup>2</sup>/<sub>3</sub> "

DC40242-17

L : 170 mm - 6 <sup>2</sup>/<sub>3</sub> "

# Cooley Derra Anastomosis Clamp Clamp Derra Cooley



No Scale - Pas d'Échelle



**DC40810-16**  
L : 170 mm - 6 <sup>2</sup>/<sub>3</sub> "

L : 170 mm - 6 <sup>2</sup>/<sub>3</sub> "

**DC40811-17**  
L : 175 mm - 6 <sup>4</sup>/<sub>5</sub> "

L : 175 mm - 6 <sup>4</sup>/<sub>5</sub> "

**DC40812-17**  
L : 170 mm - 6 <sup>2</sup>/<sub>3</sub> "

L : 170 mm - 6 <sup>2</sup>/<sub>3</sub> "



# Cooley Anastomosis Clamp

## Clamp Cooley pour Anastomoses



Cooley  
Jaws



No Scale - Pas d'Échelle

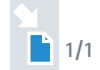

# Cooley Parry Femoral-Popliteal Anastomosis Clamp Clamp Parry Cooley pour Anastomose Fémoro-Poplitée



Cooley  
Jaws



No Scale - Pas d'Échelle

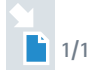

1/1



DC40820-18

L : 180 mm - 7 "



DC40821-26

L : 240 mm - 9 1/2 "

# Gregory Profunda Clamp

## Clamp Gregory pour Vaisseaux Profonds



No Scale - Pas d'Échelle

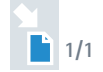

**DC40370-12**  
L : 120 mm - 4 <sup>4</sup>/<sub>5</sub> "



**DC40371-16**  
L : 160 mm - 6 <sup>1</sup>/<sub>3</sub> "



**DC40372-15**  
L : 195 mm - 7 <sup>2</sup>/<sub>3</sub> "



**DC40373-14**  
L : 140 mm - 5 <sup>1</sup>/<sub>2</sub> "





# Lees Bronchus Clamp Clamp Lees à Bronches

No Scale - Pas d'Échelle

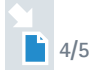

Straight Shanks  
Branches Droites



Scale - Échelle : 1/1

**DC40420-23**

L : 230 mm - 9 "

Curved Shanks  
Branches Courbes



Scale - Échelle : 1/1

**DC40421-25**

L : 250 mm - 9 4/5 "



# Bronchus Clamp

## Clamp à Bronches



Price Thomas

Mathey

Teeth on the right  
Dents à droite

**B60885**

L : 215 mm - 8 1/2 "

Teeth on the left  
Dents à gauche

**B60890**

L : 215 mm - 8 1/2 "

**DC45300-00**

L : 220 mm - 8 2/3 "



# Kocher Atrauma Intestinal Clamp

## Clamp Intestinal Atraumatique Kocher

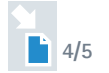

Catalogue Landanger  
Chap. IV



Straight  
Droit



Scale - Échelle : 1/1

**C10910**

L : 220 mm - 8 <sup>2</sup>/<sub>3</sub> "

**C10915**

L : 250 mm - 9 <sup>4</sup>/<sub>5</sub> "

**C10920**

L : 280 mm - 11 "



Curved  
Courbe



Scale - Échelle : 1/1

**C10925**

L : 220 mm - 8 <sup>2</sup>/<sub>3</sub> "

**C10930**

L : 250 mm - 9 <sup>4</sup>/<sub>5</sub> "

**C10935**

L : 280 mm - 11 "

# Mayo Robson Atrauma Intestinal Clamp

## Clamp Intestinal Atraumatique Mayo Robson

Catalogue Landanger  
Chap. IV

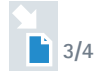

Scale - Échelle : 1/1

**C10900**  
L : 250 mm - 9 <sup>4</sup>/<sub>5</sub> "



Scale - Échelle : 1/1

**C10905**  
L : 250 mm - 9 <sup>4</sup>/<sub>5</sub> "

# Doyen Atrauma Intestinal Clamp

## Clamp Intestinal Atraumatique Doyen

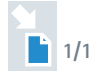

Catalogue Landanger  
Chap. IV



Straight  
Droit



- C10865**  
L : 180 mm - 7 "
- C10870**  
L : 210 mm - 8 1/3 "
- C10875**  
L : 230 mm - 9 "

Curved  
Courbe



- C10880**  
L : 175 mm - 6 4/5 "
- C10890**  
L : 210 mm - 8 1/3 "
- C10895**  
L : 230 mm - 9 "



# Baby Doyen Atrauma Intestinal Clamp

## Clamp Intestinal Atraumatique Baby Doyen

Catalogue Landanger  
Chap. IV

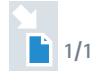

Straight  
Droit

**C10855**  
L : 130 mm - 5 1/5 "

Curved  
Courbe

**C10860**  
L : 130 mm - 5 1/5 "

# Scheibe Atrauma Vascular Intestinal Clamp

## Clamp Scheibe Vasculaire Intestinal Atraumatique



No Scale - Pas d'Échelle



DC40900-16

L : 160 mm - 6 1/3 "

# Subramanian Atrauma Vascular Intestinal Clamp

## Clamp Vasculaire Intestinal Atraumatique



No Scale - Pas d'Échelle



**DC40830-16**

L : 165 mm - 6 1/2 "



**DC40831-16**

L : 160 mm - 6 1/3 " - Right / Droite



**DC40832-15**

L : 155 mm - 6 " - Left / Gauche

# Hayes Colon Resection Clamp

## Clamp Hayes



No Scale - Pas d'Échelle

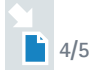

70° Jaws  
Mors 70°

Scale - Échelle : 1/1



DC40380-26   
L : 260 mm - 10 1/5 "

Scale - Échelle : 1/1



DC40381-28  
L : 280 mm - 11 "

# Dardik Multi-Purpose Clamp

## Clamp Dardik Multi-Fonctions

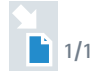

90°



**DC45600-14**

L : 140 mm - 5 1/2 "

**DC45700-14**

L : 140 mm - 5 1/2 "

45°



**DC45601-15**

L : 150 mm - 5 4/5 "

**DC45701-16**

L : 160 mm - 6 1/3 "

30°



**DC45602-15**

L : 150 mm - 5 4/5 "

**DC45702-17**

L : 170 mm - 6 2/3 "

15°



**DC45603-15**

L : 150 mm - 5 4/5 "

**DC45703-16**

L : 165 mm - 6 1/2 "



**DC45604-15**

L : 150 mm - 5 4/5 "

**DC45704-17**

L : 170 mm - 6 2/3 "

# DeBakey Multi-Purpose Clamp Clamp DeBakey Multi-Fonctions



No Scale - Pas d'Échelle

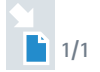

Straight Shanks  
Branches Droites



**DC40200-17**

L : 170 mm - 6 <sup>2</sup>/<sub>3</sub> "

Angled Shanks  
Branches Coudées



**DC40203-15**

L : 140 mm - 5 <sup>2</sup>/<sub>5</sub> "



Angled Shanks  
Branches Coudées



**DC40204-17**

L : 170 mm - 6 <sup>2</sup>/<sub>3</sub> "

# DeBakey Multi-Purpose Clamp

## Clamp DeBakey Multi-Fonctions



No Scale - Pas d'Échelle

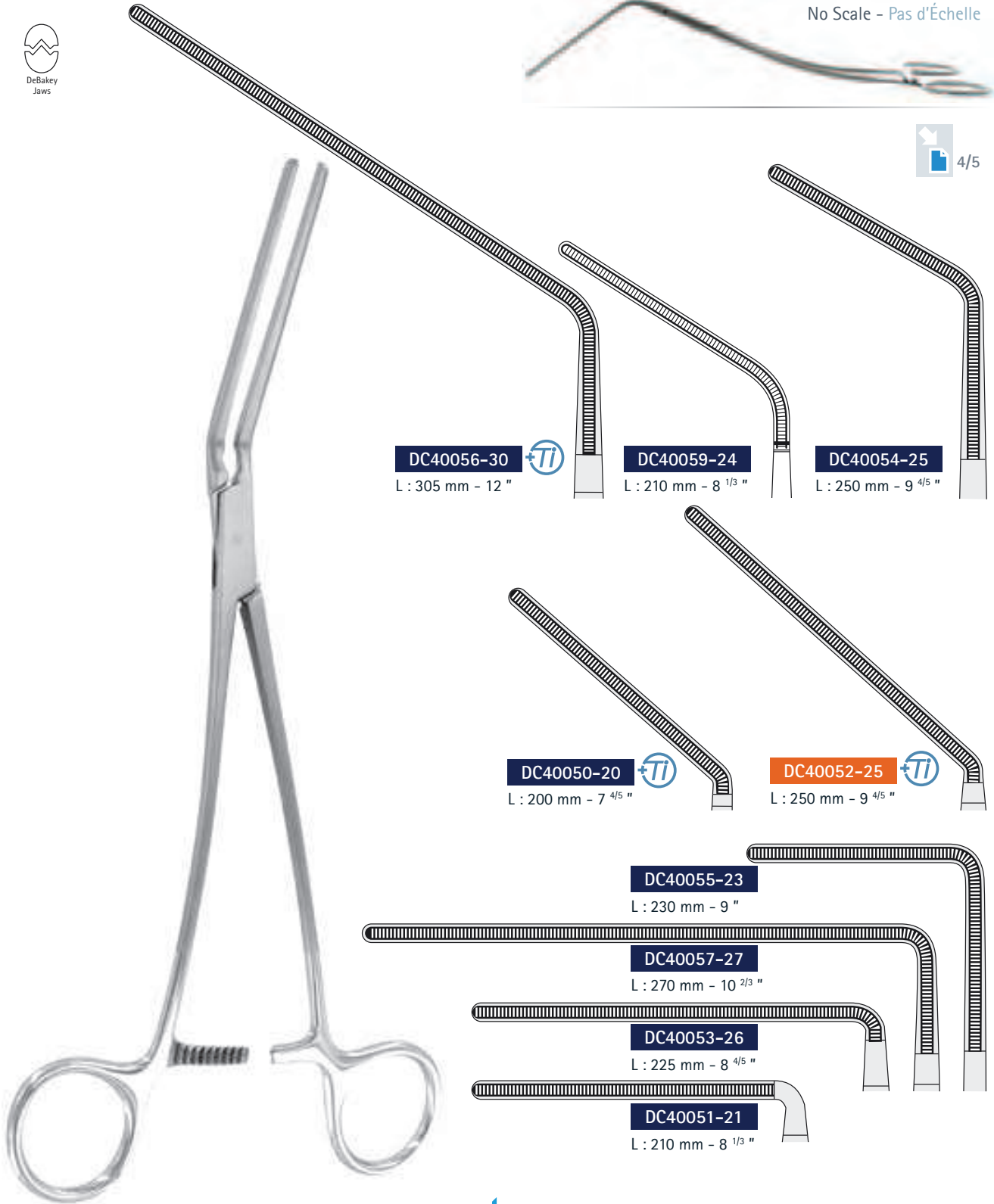

**DC40056-30**   
 L : 305 mm - 12 "

**DC40059-24**   
 L : 210 mm - 8 1/3 "

**DC40054-25**   
 L : 250 mm - 9 4/5 "

**DC40050-20**   
 L : 200 mm - 7 4/5 "

**DC40052-25**   
 L : 250 mm - 9 4/5 "

**DC40055-23**   
 L : 230 mm - 9 "

**DC40057-27**   
 L : 270 mm - 10 2/3 "

**DC40053-26**   
 L : 225 mm - 8 4/5 "

**DC40051-21**   
 L : 210 mm - 8 1/3 "

# Cooley Multi-Purpose Clamp

## Clamp Cooley Multi-Fonctions



Cooley  
Jaws

Scale : 1/1

No Scale - Pas d'Échelle

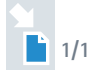

1/1



**DC40700-14**

L : 150 mm - 5 <sup>1</sup>/<sub>4</sub> "



**DC40701-16**

L : 160 mm - 6 <sup>1</sup>/<sub>3</sub> "



**DC40702-16**

L : 170 mm - 6 <sup>2</sup>/<sub>3</sub> "



# Cooley Multi-Purpose Clamp

## Clamp Cooley Multi-Fonctions



Cooley  
Jaws

Scale : 4/5



No Scale - Pas d'Échelle

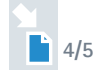

4/5

Scale - Échelle : 1/1



**DC40680-20**

L : 205 mm - 8 "

**DC40681-24**

L : 240 mm - 9 1/2 "

# Cooley Multi-Purpose Clamp Clamp Cooley Multi-Fonctions

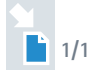

DC40618-20

L : 200 mm - 7 <sup>4</sup>/<sub>5</sub> "

# DeBakey Ligature Carrier Clamp

## Clamp Passe-Fils DeBakey



No Scale - Pas d'Échelle



DC40030-17

L : 170 mm - 6 <sup>3</sup>/<sub>4</sub>"



DC40031-17

L : 170 mm - 6 <sup>3</sup>/<sub>4</sub>"

# DeBakey Dissecting and Ligature Forceps Clamp

## Clamp Dissecteur DeBakey

No Scale - Pas d'Échelle

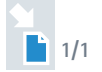

DC40070-19

L : 190 mm - 7 1/2 "



DC40071-23

L : 230 mm - 9 "



# DeBakey Semb Ligature Carrier Clamp

## Clamp Passe-Fils Semb DeBakey



No Scale - Pas d'Échelle

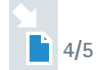

Scale - Échelle : 1/1



**DC40270-23**

L : 230 mm - 9 "

Scale - Échelle : 1/1



**DC40271-26**

L : 260 mm - 10 <sup>1</sup>/<sub>5</sub> "

# Cooley Beck Vessel Clamp

## Clamp Vasculaire Beck Cooley

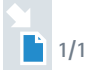

**DC40800-14**  
L : 140 mm - 5 1/2 "



**DC40801-15**  
L : 150 mm - 6 "

# Cooley Ligature Carrier Clamp

## Clamp Passe-Fils Cooley



Cooley  
Jaws



No Scale - Pas d'Échelle

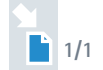

# Gemini Dissector

## Dissecteur Gemini

No Scale - Pas d'Échelle

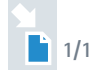

1.3 mm Jaws  
Mors 1,3 mm



**DC43711-13**

L : 135 mm - 5 <sup>2</sup>/<sub>5</sub> "

**DC43711-18**

L : 180 mm - 7 "

**DC43710-13**

L : 140 mm - 5 <sup>2</sup>/<sub>5</sub> "

**DC43710-18**

L : 180 mm - 7 "

**DC43710-21**

L : 205 mm - 8 <sup>1</sup>/<sub>3</sub> "

**DC43710-23**

L : 230 mm - 9 "

**DC43710-25**

L : 250 mm - 9 <sup>4</sup>/<sub>5</sub> "

**DC43710-28**

L : 280 mm - 11 "

**DC43711-21**

L : 210 mm - 8 <sup>1</sup>/<sub>3</sub> "

**DC43711-23**

L : 230 mm - 9 "

**DC43711-25**

L : 250 mm - 9 <sup>4</sup>/<sub>5</sub> "

**DC43711-28**

L : 280 mm - 11 "



# O'Shaugnessy Dissector

## Dissecteur O'Shaugnessy

Catalogue Landanger  
Chap. IV

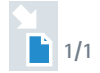

90° Curved - Strong  
Courbe 90° - Modèle Fort

90° Curved - Fine  
Courbe 90° - Modèle Fin

45° Curved - Strong  
Courbe 45° - Modèle Fort

45° Curved - Fine  
Courbe 45° - Modèle Fin

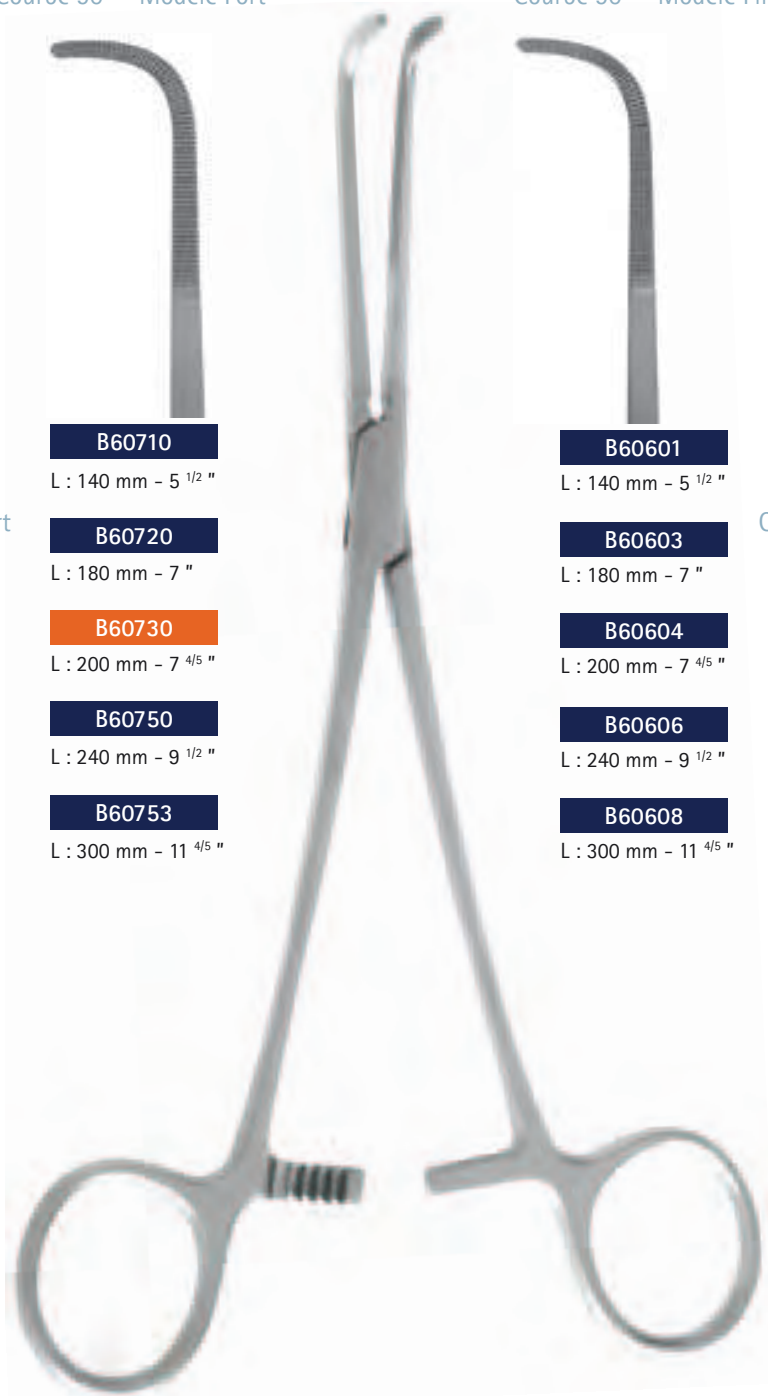

**B60710**

L : 140 mm - 5 1/2 "

**B60720**

L : 180 mm - 7 "

**B60730**

L : 200 mm - 7 4/5 "

**B60750**

L : 240 mm - 9 1/2 "

**B60753**

L : 300 mm - 11 4/5 "

**B60601**

L : 140 mm - 5 1/2 "

**B60603**

L : 180 mm - 7 "

**B60604**

L : 200 mm - 7 4/5 "

**B60606**

L : 240 mm - 9 1/2 "

**B60608**

L : 300 mm - 11 4/5 "

**B60610**

L : 140 mm - 5 1/2 "

**B60620**

L : 180 mm - 7 "

**B60630**

L : 200 mm - 7 4/5 "

**B60650**

L : 240 mm - 9 1/2 "

**B60670**

L : 300 mm - 11 4/5 "

**B60540**

L : 140 mm - 5 1/2 "

**B60550**

L : 180 mm - 7 "

**B60560**

L : 200 mm - 7 4/5 "

**B60580**

L : 240 mm - 9 1/2 "

# Dissector Dissecteur

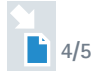

Catalogue Landanger  
Chap. IV



Saylor



**B60820**  
L : 260 mm - 10 1/5 "

Redon



**B60535**  
L : 140 mm - 5 1/2 "

# DeBakey Ring Handle Bulldog Clamp

## Clamp Bulldog à Anneaux DeBakey

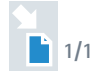

Mosquito



DC40100-12

L : 120 mm - 4 <sup>3</sup>/<sub>4</sub> "

Mosquito



DC40101-12

L : 120 mm - 4 <sup>3</sup>/<sub>4</sub> "

Kelly



DC40110-14

L : 140 mm - 5 <sup>4</sup>/<sub>5</sub> "

Kelly



DC40111-14

L : 140 mm - 5 <sup>4</sup>/<sub>5</sub> "

Rankin



DC40120-16

L : 160 mm - 6 <sup>1</sup>/<sub>3</sub> "

Rankin



DC40121-16

L : 160 mm - 6 <sup>1</sup>/<sub>3</sub> "



# DeBakey Ring Handle Bulldog Clamp

## Clamp Bulldog à Anneaux DeBakey

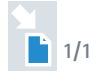

Straight Shanks  
Branches Droites



**DC40000-14**  
L : 140 mm - 5 1/2 "

Curved Shanks  
Branches Courbes

No Scale - Pas d'Échelle



**DC40003-13**  
L : 130 mm - 5 1/5 "

Angled Shanks  
Branches Coudées

No Scale - Pas d'Échelle



**DC40001-13**  
L : 130 mm - 5 1/5 "



**DC40002-11**  
L : 110 mm - 4 2/5 "



**DC40004-13**  
L : 130 mm - 5 1/5 "



# Cooley Ring Handle Bulldog Clamp

## Clamp Bulldog à Anneaux Cooley



No Scale - Pas d'Échelle



Curved Shanks  
Branches Courbes



Straight Shanks  
Branches Droites



**DC40600-13**  
L : 130 mm - 5 1/5 "



**DC40603-13**  
L : 130 mm - 5 1/5 "

**DC40604-13**  
L : 130 mm - 5 1/5 "



**DC40605-12**  
L : 120 mm - 4 4/5 "

Angled Shanks  
Branches Coudées



**DC40601-12**  
L : 125 mm - 4 4/5 "



**DC40602-10**   
L : 105 mm - 4 1/5 "



**DC40607-13**  
L : 135 mm - 5 2/5 "



**DC40606-12**  
L : 125 mm - 4 4/5 "

# Johns Hopkins Bulldog Clamp Clamp Bulldog Johns Hopkins

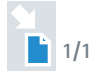

Closing pressure 500 grammes  
Pression 500 grammes

Straight  
Droit



**DC41015-30**

L : 30 mm - 1 <sup>1</sup>/<sub>5</sub> "

**DC41000-38**

L : 38 mm - 1 <sup>1</sup>/<sub>2</sub> "

**DC41001-47**

L : 47 mm - 2 "

**DC41002-57**

L : 57 mm - 2 <sup>1</sup>/<sub>4</sub> "

**DC41003-65**

L : 65 mm - 2 <sup>1</sup>/<sub>2</sub> "

**DC41004-70**

L : 70 mm - 2 <sup>3</sup>/<sub>4</sub> "

**DC41005-75**

L : 75 mm - 3 "

**DC41006-92**

L : 92 mm - 3 <sup>1</sup>/<sub>2</sub> "

Curved  
Courbe



**DC41016-30**

L : 30 mm - 1 <sup>1</sup>/<sub>5</sub> "

**DC41007-38**

L : 38 mm - 1 <sup>1</sup>/<sub>2</sub> "

**DC41008-47**

L : 47 mm - 2 "

**DC41009-57**

L : 57 mm - 2 <sup>1</sup>/<sub>4</sub> "

**DC41010-65**

L : 65 mm - 2 <sup>1</sup>/<sub>2</sub> "

**DC41011-70**

L : 70 mm - 2 <sup>3</sup>/<sub>4</sub> "

**DC41012-75**

L : 75 mm - 3 "

**DC41013-92**

L : 92 mm - 3 <sup>1</sup>/<sub>2</sub> "

# Bulldog Clamp Clamp Bulldog

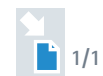

## Dubost

Closing pressure 300 grammes  
Pression 300 grammes



DC41600-05

L : 50 mm - 2 "



DC41602-05

L : 50 mm - 2 "



DC41603-06

L : 60 mm - 2 1/4 "



Bulldog Clamp  
Setting Forceps  
Applicateur pour  
Clamp Bulldog

DC41052-00

L : 240 mm - 9 1/2 "

# DeBakey Bulldog Clamp

## Clamp Bulldog DeBakey

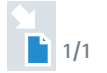



Closing pressure 250 grammes  
Pression 250 grammes

Straight  
Droit



- DC41100-23** 

L : 80 mm - 3 1/5 " - Jaws / Mors : 23 mm
- DC41101-29** 

L : 88 mm - 3 1/2 " - Jaws / Mors : 29 mm
- DC41102-50** 

L : 110 mm - 4 1/3 " - Jaws / Mors : 50 mm
- DC41103-66** 

L : 125 mm - 4 4/5 " - Jaws / Mors : 66 mm
- DC41104-70** 

L : 130 mm - 5 1/5 " - Jaws / Mors : 70 mm

Curved  
Courbe



- DC41105-21**

L : 77 mm - 3 " - Jaws / Mors : 21 mm
- DC41106-23** 

L : 80 mm - 3 1/5 " - Jaws / Mors : 23 mm
- DC41107-32** 

L : 90 mm - 3 1/2 " - Jaws / Mors : 32 mm
- DC41108-49** 

L : 105 mm - 4 1/5 " - Jaws / Mors : 49 mm
- DC41109-64** 

L : 123mm - 4 4/5 " - Jaws / Mors : 64 mm



# Cooley Bulldog Clamp

## Clamp Bulldog Cooley

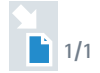

Straight  
Droit



**DC41530-08**

L : 80 mm - 3 " - Jaws / Mors : 24 mm

**DC41531-09**

L : 90 mm - 3 1/2 " - Jaws / Mors : 32 mm

**DC41532-11**

L : 110 mm - 4 2/5 " - Jaws / Mors : 47 mm

**DC41533-13**

L : 130 mm - 5 1/5 " - Jaws / Mors : 70 mm

Curved  
Courbe



**DC41534-07**

L : 75 mm - 3 " - Jaws / Mors : 24 mm

**DC41535-08**

L : 80 mm - 3 " - Jaws / Mors : 32 mm

**DC41536-10**

L : 100 mm - 4 " - Jaws / Mors : 47 mm

**DC41537-11**

L : 115 mm - 4 3/5 " - Jaws / Mors : 70 mm

# DeBakey Bulldog Clamp Clamp Bulldog DeBakey

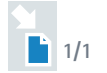

## Santulli



**DC41520-25**  
L : 80 mm - 3 "

**DC41402-08**  
L : 80 mm - 3 "

## Gregory



**DC41121-15**  
L : 110 mm - 4 <sup>2</sup>/<sub>5</sub> "

**DC41121-12**  
L : 115 mm - 4 <sup>3</sup>/<sub>5</sub> "

**DC41400-09**  
L : 90 mm - 3 <sup>1</sup>/<sub>2</sub> "

**DC41401-11**  
L : 110 mm - 4 <sup>2</sup>/<sub>5</sub> "

# DeBakey Gregory Bulldog Clamp Clamp Bulldog Gregory DeBakey

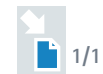

**DC41410-11**  
L : 105 mm - 4 1/5 "

**DC41411-12**  
L : 120 mm - 4 4/5 "

**DC41412-11**  
L : 115 mm - 4 2/5 "

**DC41413-11**  
L : 115 mm - 4 2/5 "

# Diethrich Bulldog Clamp Clamp Bulldog Diethrich

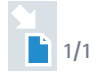

Closing pressure 80 grammes  
Pression 80 grammes

Serrated Jaws - Straight  
Mors Striés - Droits



**DC41220-49**

L : 49 mm 2 " - Jaws / Mors : 8 mm

**DC41220-53**

L : 53 mm 2 " - Jaws / Mors : 12 mm

**DC41220-57**

L : 57 mm 2 1/4 " - Jaws / Mors : 20 mm

Serrated Jaws - Angled  
Mors Striés - Coudés



**DC41230-48**

L : 48 mm 2 " - Jaws / Mors : 8 mm

**DC41230-50**

L : 50 mm 2 " - Jaws / Mors : 12 mm

**DC41230-52**

L : 55 mm 2 " - Jaws / Mors : 20 mm

Smooth Jaws - Angled  
Mors Lisses - Coudés



**DC41240-50**

L : 50 mm 2 " - Jaws / Mors : 13 mm

**DC41240-55**

L : 55 mm 2 1/5 " - Jaws / Mors : 20 mm

Closing pressure 180 grammes  
Pression 180 grammes



Straight Jaws  
Mors Droits



**DC41200-47**

L : 49 mm - 2 " - Jaws / Mors : 10 mm

**DC41200-51**

L : 51 mm - 2 " - Jaws / Mors : 14 mm

**DC41200-57**

L : 57 mm - 2 1/5 " - Jaws / Mors : 20 mm

Angled Jaws  
Mors Coudés



**DC41210-44**

L : 44 mm - 1 4/5 " - Jaws / Mors : 10 mm

**DC41210-46**

L : 46 mm - 1 4/5 " - Jaws / Mors : 14 mm

**DC41210-49**

L : 49 mm - 2 " - Jaws / Mors : 20 mm

Curved Jaws  
Mors Courbes



**DC41210-54**

L : 54 mm - 2 1/5 " - Jaws / Mors : 20 mm

# Bulldog Clamp

## Clamp Bulldog

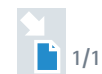

Closing pressure 250 grammes  
Pression 250 grammes

**Diethrich**  
Straight  
Droit



Serrated Jaws  
Mors Striés

**DC41030-09**

L : 52 mm - Jaws / Mors : 8 mm

**DC41031-13**

L : 57 mm - Jaws / Mors : 13 mm

**DC41032-18**

L : 63 mm - Jaws / Mors : 18 mm

DeBakey Jaws  
Mors DeBakey

**DC41033-10**

L : 53 mm - Jaws / Mors : 12 mm

**DC41034-14**

L : 56 mm - Jaws / Mors : 14 mm

**DC41035-22**

L : 63 mm - Jaws / Mors : 22 mm

**Diethrich**  
Angled  
Coudé



Serrated Jaws  
Mors Striés

**DC41037-08**

L : 51 mm - Jaws / Mors : 8 mm

**DC41038-12**

L : 55 mm - Jaws / Mors : 12 mm

**DC41039-16**

L : 58 mm - Jaws / Mors : 19 mm

**Diethrich**  
Curved  
Courbe



Serrated Jaws  
Mors Striés

**DC41040-20**

L : 60 mm - Jaws / Mors : 20 mm

Closing pressure 300 grammes  
Pression 300 grammes

**DeBakey**  
Angled  
Coudé



DeBakey Jaws  
Mors DeBakey

**DC41043-11**

L : 52 mm - Jaws / Mors : 11 mm

**DC41044-16**

L : 55 mm - Jaws / Mors : 16 mm

**DC41045-20**

Jaws / Mors : 20 mm

**Hess**  
Straight  
Droit



Serrated Jaws  
Mors Striés

**DC41050-20**

L : 52 mm - Jaws / Mors : 20 mm

**DC41051-28**

L : 60 mm - Jaws / Mors : 28 mm

# DeBakey Glover Bulldog Clamp Clamp Bulldog Glover DeBakey

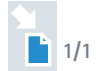

Adjustable Pressure  
Pression Réglable

Glover-Satinsky



**DC41300-00**

L : 58 mm - 2 1/5 "

Angled  
Coudé



**DC41710-05**

L : 53 mm - 2 1/4 "

Straight  
Droit



**DC41700-06**

L : 60 mm - 2 1/4 "

**DC41701-07**

L : 69 mm - 2 3/4 "

**DC41702-08**

L : 85 mm - 3 1/2 "

**DC41703-13**

L : 130 mm - 5 1/5 "

Curved  
Courbe



**DC41704-06**

L : 55 mm - 2 1/4 "

**DC41705-07**

L : 65 mm - 2 1/2 "

**DC41706-08**

L : 80 mm - 3 1/2 "

**DC41707-13**

L : 130 mm - 5 1/5 "

Carotid  
Carotide



**DC41301-00**

L : 77 mm - 3 "

# DeBakey Bulldog Clamp

## Clamp Bulldog DeBakey

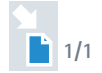

Adjustable Pressure  
Pression Réglable

Straight  
Droit



DC41111-04

L : 45 mm - 1 3/4 "

Curved  
Courbe



DC41114-04

L : 47 mm - 1 4/5 "

# Atraumatic Bulldog Clamp

## Clamp Bulldog Atraumatiques

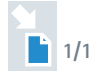

Mini Glover  
Titanium / Titane

Closing pressure 400 grammes  
Pression 400 grammes



Artery  
Artères

**DC41500-03TI**

L : 30 mm - 1 1/5 "

**DC41502-03TI**

L : 35 mm - 1 1/4 "

**DC41504-04TI**

L : 40 mm - 1 3/5 "

**DC41506-05TI**

L : 50 mm - 2 "



Artery  
Artères

**DC41510-03TI**

L : 30 mm - 1 1/5 "

**DC41512-03TI**

L : 35 mm - 1 1/4 "

**DC41514-04TI**

L : 40 mm - 1 3/5 "

**DC41516-05TI**

L : 50 mm - 2 "

Closing pressure 200 grammes  
Pression 200 grammes

Vein  
Veines

**DC41501-03TI**

L : 30 mm - 1 1/5 "

**DC41503-03TI**

L : 35 mm - 1 1/4 "

**DC41505-04TI**

L : 40 mm - 1 3/5 "

**DC41507-05TI**

L : 50 mm - 2 "

Vein  
Veines

**DC41511-03TI**

L : 30 mm - 1 1/5 "

**DC41513-03TI**

L : 35 mm - 1 1/4 "

**DC41515-04TI**

L : 40 mm - 1 3/5 "

**DC41517-05TI**

L : 50 mm - 2 "



# Atraumatic Bulldog Clamp

## Clamp Bulldog Atraumatiques

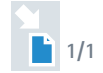

Mini Glover  
Strongly Curved / Très Courbe

Closing pressure 400 grammes  
Pression 400 grammes



Artery  
Artères

**DC41520-03**

L : 30 mm - 1 1/5 "

**DC41522-03**

L : 35 mm - 1 1/4 "

**DC41524-04**

L : 40 mm - 1 3/5 "

**DC41526-05**

L : 45 mm - 1 4/5 "

Closing pressure 200 grammes  
Pression 200 grammes

Vein  
Veines

**DC41521-03**

L : 30 mm - 1 1/5 "

**DC41523-03**

L : 35 mm - 1 1/4 "

**DC41525-04**

L : 40 mm - 1 3/5 "

**DC41527-05**

L : 50 mm - 2 "

# Bulldog Clamp

## Clamp Bulldog

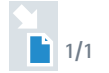

Mini Glover

Closing pressure 80 grammes  
Pression 80 grammes



**DC41610-35**

L : 35 mm - 1 1/4 "  
Straight Jaws / Mors Droit : 14 mm



**DC41611-35**

L : 35 mm - 1 1/4 "  
Curved Jaws / Mors Courbes : 14 mm



**DC41612-35**

L : 35 mm - 1 1/4 "  
Curved Jaws / Mors Courbes : 14 mm



**DC41613-35**

L : 35 mm - 1 1/4 "  
Angled Jaws / Mors Coudés : 14 mm

# DeBakey Coarctation Clamp

## Clamp DeBakey pour Coarctation de l'Aorte

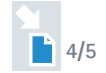

Straight Shanks  
Branches Droites



Scale - Échelle : 1/1



**DC40290-20**

L : 200 mm - 7 <sup>4</sup>/<sub>5</sub> "

**DC40290-23**

L : 230 mm - 9 "

**DC40290-26**

L : 270 mm - 10 <sup>2</sup>/<sub>3</sub> "

**DC40290-31**

L : 315 mm - 12 <sup>2</sup>/<sub>5</sub> "

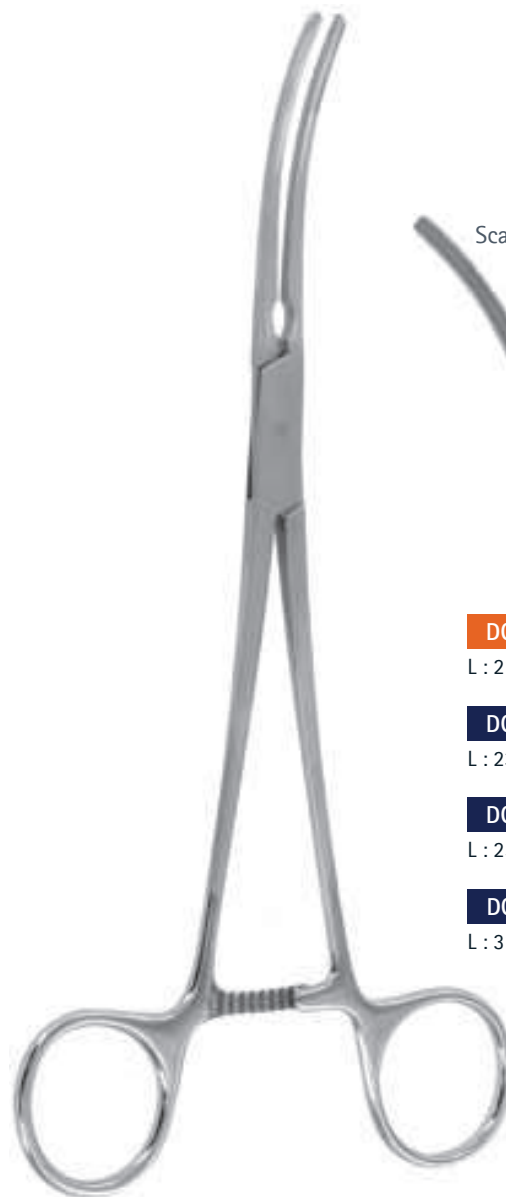

Scale - Échelle : 1/1



**DC40291-20**

L : 215 mm - 8 <sup>1</sup>/<sub>2</sub> "

**DC40291-23**

L : 230 mm - 9 "

**DC40291-26**

L : 255 mm - 10 "

**DC40291-31**

L : 310 mm - 12 <sup>1</sup>/<sub>5</sub> "

# Glover Patent-Ductus and Coarctation Clamp

## Clamp Glover pour Canal Artériel Persistant ou Coarctation



No Scale - Pas d'Échelle

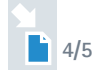

Straight Shanks  
Branches Droites

Scale - Échelle : 1/1



DC40340-22



L : 210 mm - 8 1/3 "

Angled Shanks  
Branches Coudées

Scale - Échelle : 1/1



DC40343-20



L : 205 mm - 8 "



DC40341-23



L : 230 mm - 9 "



DC40342-26

L : 260 mm - 10 1/5 "



DC40344-23



L : 235 mm - 9 "



DC40345-26

L : 260 mm - 10 1/5 "

# Cooley Patent Ductus and Coarctation Clamp

## Clamp Cooley pour Canal Artériel Persistant ou Coarctation



No Scale - Pas d'Échelle

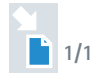

1/1



**DC40629-17**

L : 170 mm - 6 <sup>2</sup>/<sub>3</sub> "

**DC40631-17**

L : 175 mm - 6 <sup>4</sup>/<sub>5</sub> "

**DC40632-20**

L : 205 mm - 8 "

**DC40630-16**

L : 160 mm - 6 <sup>1</sup>/<sub>3</sub> "

**DC40627-17**

L : 170 mm - 6 <sup>2</sup>/<sub>3</sub> "

**DC40633-22**

L : 220 mm - 8 <sup>2</sup>/<sub>3</sub> "

**DC40634-25**

L : 255 mm - 10 "

# Cooley Patent Ductus and Coarctation Clamp

## Clamp Cooley pour Canal Artériel Persistant ou Coarctation



Straight Shanks  
Branches Droites

No Scale - Pas d'Échelle

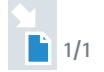

**DC40620-16**   
L : 160 mm - 6 1/3 "

**DC40621-17**   
L : 175 mm - 6 4/5 "

**DC40622-16**   
L : 160 mm - 6 1/3 "

**DC40623-17**   
L : 175 mm - 6 4/5 "

**DC40624-21**   
L : 210 mm - 8 1/3 "

**DC40625-22**   
L : 220 mm - 8 2/3 "

**DC40626-26**   
L : 260 mm - 10 1/5 "

# Very Delicate DeBakey Clamp

## Clamp DeBakey Très Délicat

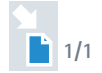

Straight Shanks  
Branches Droites



**DC42600-16**

L : 165 mm - 6 1/2 "

Curved Shanks  
Branches Courbes



**DC42601-16**

L : 160 mm - 6 1/3 "



**DC42602-16**

L : 155 mm - 6 "



**DC42603-16**

L : 155 mm - 6 "



**DC42604-16**

L : 155 mm - 6 "

# Castaneda Clamp Clamp Castaneda

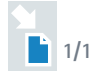

No Scale - Pas d'Échelle



Straight Shanks  
Branches Droites



<b>DC42000-00</b> L : 120 mm - 4 4/5 "	<b>DC42001-30</b> L : 110 mm - 4 2/5 "	<b>DC42002-45</b> L : 120 mm - 4 4/5 "	<b>DC42003-60</b> L : 110 mm - 4 2/5 "	<b>DC42004-90</b> L : 105 mm - 4 1/5 "	<b>DC42005-00</b> L : 120 mm - 4 4/5 "
<b>DC42006-00</b> L : 120 mm - 4 4/5 "	<b>DC42007-00</b> L : 120 mm - 4 4/5 "	<b>DC42008-00</b> L : 115 mm - 4 3/5 "	<b>DC42009-00</b> L : 110 mm - 4 2/5 "	<b>DC42010-00</b> L : 115 mm - 4 3/5 "	<b>DC42011-00</b> L : 120 mm - 4 4/5 "
<b>DC42012-00</b> L : 130 mm - 5 1/5 "	<b>DC42013-00</b> L : 115 mm - 4 3/5 "	<b>DC42014-00</b> L : 110 mm - 4 2/5 "	<b>DC42015-00</b> L : 120 mm - 4 4/5 "	<b>DC42016-00</b> L : 120 mm - 4 4/5 "	<b>DC42017-00</b> L : 120 mm - 4 4/5 "



# Castaneda Clamp

## Clamp Castaneda

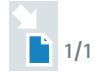

No Scale - Pas d'Échelle

Curved Shanks  
Branches Courbes

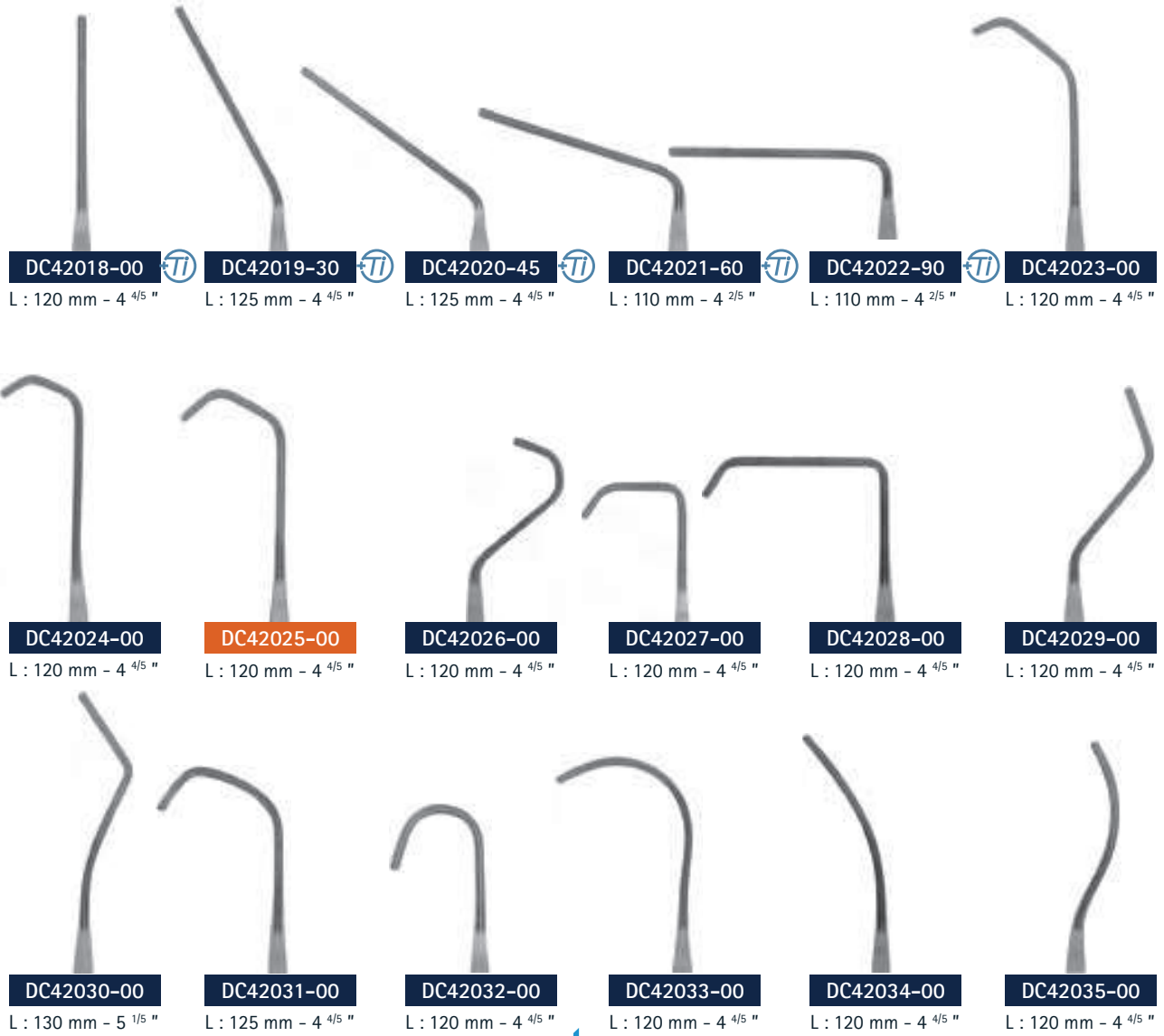

# Castaneda Clamp Clamp Castaneda

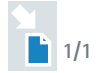

No Scale - Pas d'Échelle

Angled Shanks  
Branches Coudées



<b>DC42036-00</b>	<b>DC42037-30</b>	<b>DC42038-45</b>	<b>DC42039-60</b>	<b>DC42040-90</b>	<b>DC42041-00</b>
L : 120 mm - 4 4/5 "	L : 125 mm - 4 4/5 "	L : 125 mm - 4 4/5 "	L : 110 mm - 4 2/5 "	L : 110 mm - 4 2/5 "	L : 125 mm - 4 4/5 "
<b>DC42042-00</b>	<b>DC42043-00</b>	<b>DC42044-00</b>	<b>DC42045-00</b>	<b>DC42046-00</b>	<b>DC42047-00</b>
L : 120 mm - 4 4/5 "	L : 120 mm - 4 4/5 "	L : 120 mm - 4 4/5 "	L : 110 mm - 4 2/5 "	L : 110 mm - 4 2/5 "	L : 120 mm - 4 4/5 "
<b>DC42048-00</b>	<b>DC42049-00</b>	<b>DC42050-00</b>	<b>DC42051-00</b>	<b>DC42052-00</b>	<b>DC42053-00</b>
L : 120 mm - 4 4/5 "	L : 110 mm - 4 2/5 "	L : 120 mm - 4 4/5 "	L : 120 mm - 4 4/5 "	L : 120 mm - 4 4/5 "	L : 115 mm - 4 3/5 "

# Castaneda Clamp

## Clamp Castaneda

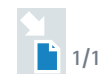

No Scale - Pas d'Échelle

Very Angled Shanks  
Branches Fortement Coudées

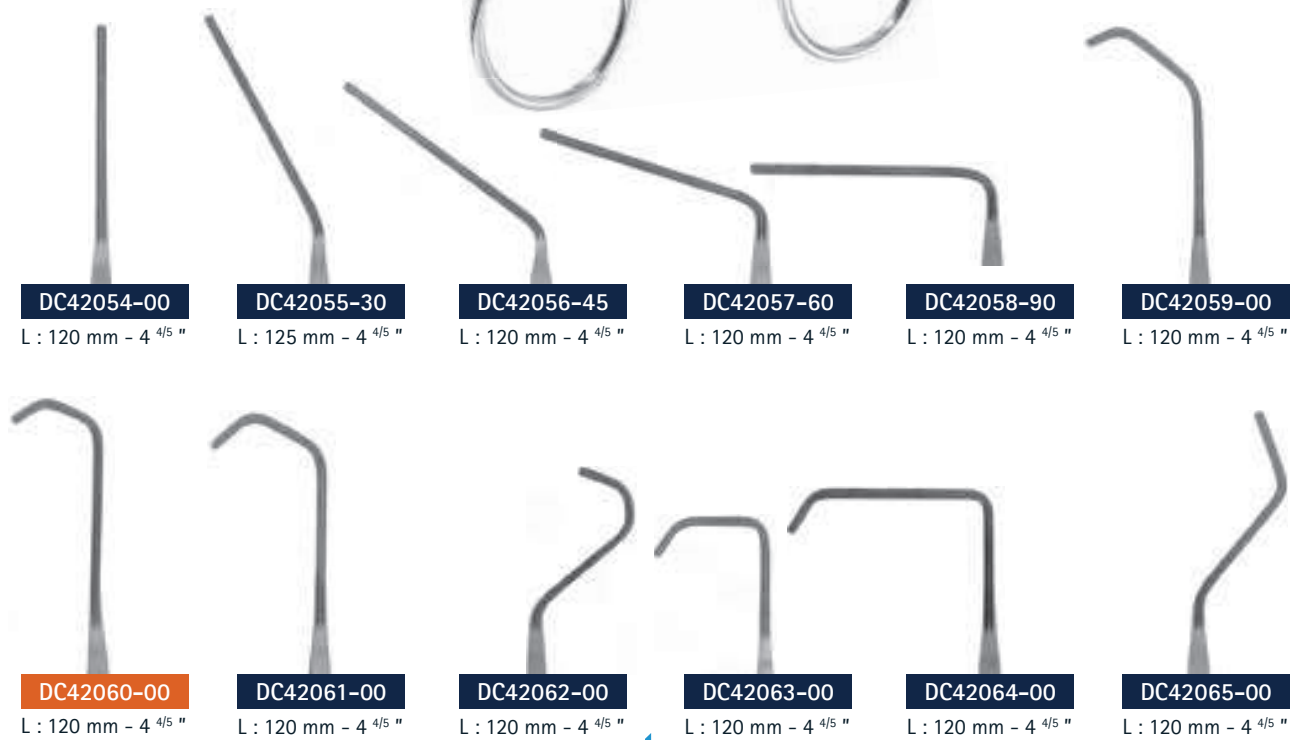

**DC42054-00**  
L : 120 mm - 4 4/5 "

**DC42055-30**  
L : 125 mm - 4 4/5 "

**DC42056-45**  
L : 120 mm - 4 4/5 "

**DC42057-60**  
L : 120 mm - 4 4/5 "

**DC42058-90**  
L : 120 mm - 4 4/5 "

**DC42059-00**  
L : 120 mm - 4 4/5 "

**DC42060-00**  
L : 120 mm - 4 4/5 "

**DC42061-00**  
L : 120 mm - 4 4/5 "

**DC42062-00**  
L : 120 mm - 4 4/5 "

**DC42063-00**  
L : 120 mm - 4 4/5 "

**DC42064-00**  
L : 120 mm - 4 4/5 "

**DC42065-00**  
L : 120 mm - 4 4/5 "

# Castaneda Neonatal Clamp

## Clamp Neonatal Castaneda

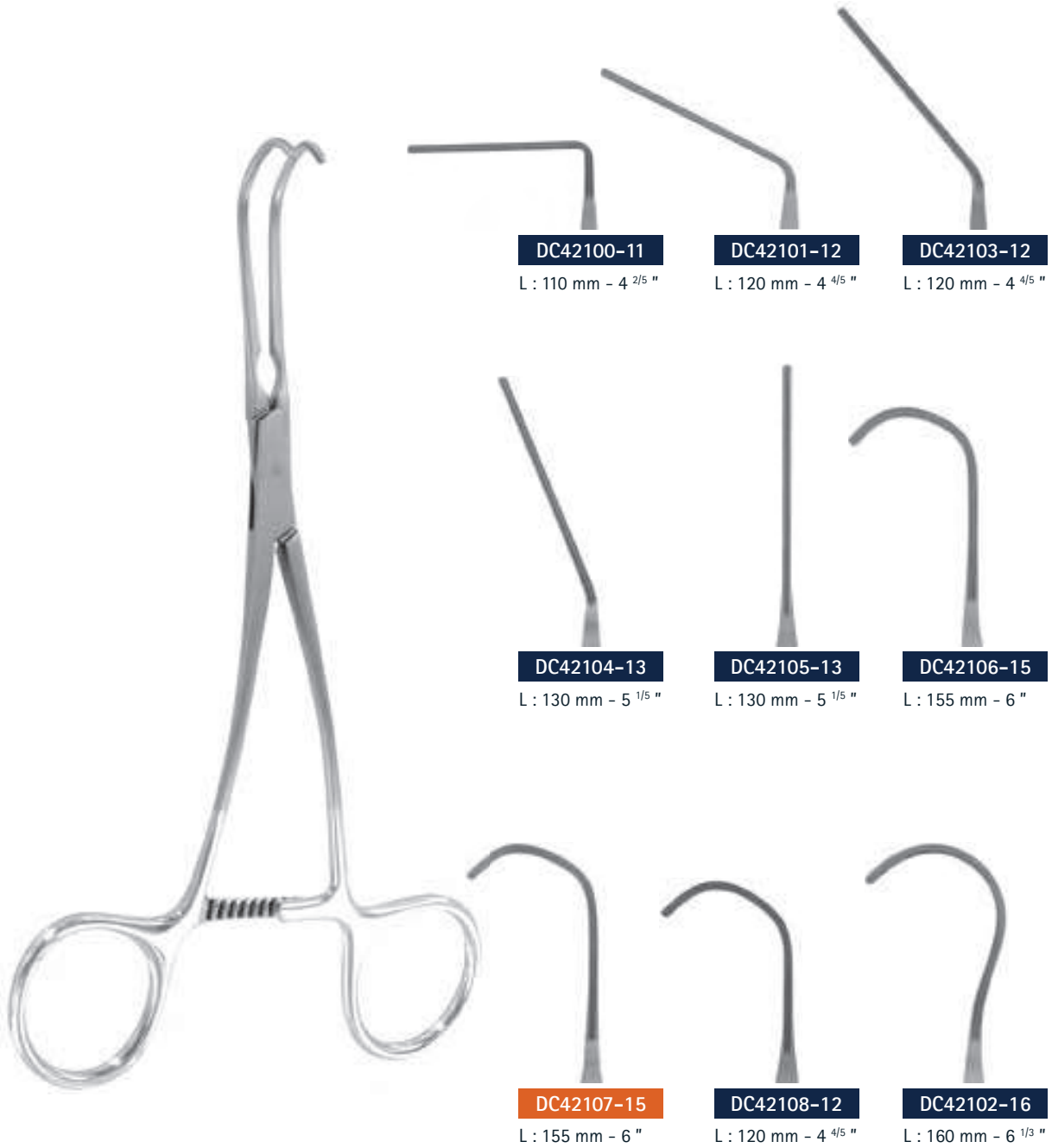
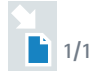

# Infant Curved Neonatal Micro Vascular Clamp

## Clamp Micro Vasculaire Néonatal Castaneda

No Scale - Pas d'Échelle

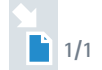

Streaked and Graduated Jaws  
Mors Gradués et Striés



**DC42200-13**  
L : 130 mm - 5 1/5 "



**DC42201-13**  
L : 130 mm - 5 1/5 "



**DC42202-13**  
L : 130 mm - 5 1/5 "



**DC42203-12**  
L : 125 mm - 4 4/5 "



**DC42204-11**  
L : 110 mm - 4 2/5 "



**DC42205-15**  
L : 150 mm - 5 4/5 "



**DC42206-15**  
L : 150 mm - 5 4/5 "



**DC42207-15**  
L : 150 mm - 5 4/5 "



**DC42208-12**  
L : 120 mm - 4 4/5 "

# Cooley Pediatric Vascular Clamp

## Clamp Pédiatrique Vasculaire Cooley

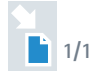

Straight Shanks  
Branches Droites



**DC42300-14**  
L : 140 mm - 5 1/2 "

Curved Shanks  
Branches Courbes



**DC42407-14**  
L : 135 mm - 5 2/5 "



**DC42301-14**  
L : 140 mm - 5 1/2 "



**DC42302-14**  
L : 140 mm - 5 1/2 "



**DC42303-14**  
L : 145 mm - 5 2/3 "



**DC42306-14**  
L : 140 mm - 5 1/2 "



**DC42304-14**  
L : 140 mm - 5 1/2 "



**DC42411-15**  
L : 145 mm - 5 2/3 "



**DC42305-17**  
L : 170 mm - 6 2/3 "

# "Prestige" Haemostatic Forceps Pinces Hémostatiques "Prestige"

Catalogue Landanger  
Chap. IV

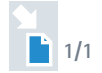

Kocher



Straight  
With Teeth  
Droite  
Avec Griffes

**B86580**  
L : 160 mm - 6 1/3 "

Kelly



Straight  
Without Teeth  
Droite  
Sans Griffes

**B86595**  
L : 160 mm - 6 1/3 "

Curved  
Without Teeth  
Courbe  
Sans Griffes

**B86590**  
L : 160 mm - 6 1/3 "

# "Prestige" Haemostatic Forceps Pincés Hémostatiques "Prestige"

Catalogue Landanger  
Chap. IV

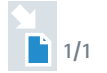

Crile



Curved  
Without Teeth  
Courbe  
Sans Griffes

**B86600**

L : 140 mm - 5 "

Christophe



Curved  
Without Teeth  
Courbe  
Sans Griffes

**B86610**

L : 160 mm - 6 1/3 "



# "Prestige" Leriche Haemostatic Forceps

## Pinces Hémostatiques Leriche "Prestige"

Catalogue Landanger  
Chap. IV

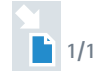

Straight  
With Teeth  
Droite  
À Griffes



**B86520**

L : 150 mm - 5 <sup>4</sup>/<sub>5</sub> "

**B86540**

L : 180 mm - 7 "

Without Teeth  
Sans Griffes



**B86525**

L : 150 mm - 5 <sup>4</sup>/<sub>5</sub> "

**B86545**

L : 180 mm - 7 "

Curved  
With Teeth  
Courbe  
À Griffes



**B86530**

L : 150 mm - 5 <sup>4</sup>/<sub>5</sub> "

**B86550**

L : 180 mm - 7 "

Without Teeth  
Sans Griffes



**B86535**

L : 150 mm - 5 <sup>4</sup>/<sub>5</sub> "

**B86555**

L : 180 mm - 7 "



# "Prestige" Halstead Haemostatic Forceps

## Pincés Hémostatiques Halstead "Prestige"

Catalogue Landanger  
Chap. IV

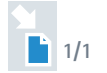

Straight  
With Teeth  
Droite  
À Griffes



**B86500**  
L : 120 mm - 4 4/5 "

Without Teeth  
Sans Griffes

**B86505**  
L : 120 mm - 4 4/5 "

Curved  
With Teeth  
Courbe  
À Griffes



**B86510**  
L : 120 mm - 4 4/5 "

Without Teeth  
Sans Griffes

**B86515**  
L : 120 mm - 4 4/5 "

# Bengolea "Prestige" Haemostatic Forceps

## Pinces Hémostatiques Bengolea "Prestige"

Catalogue Landanger  
Chap. IV

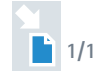

Curved Without Teeth  
Courbe Sans Griffes

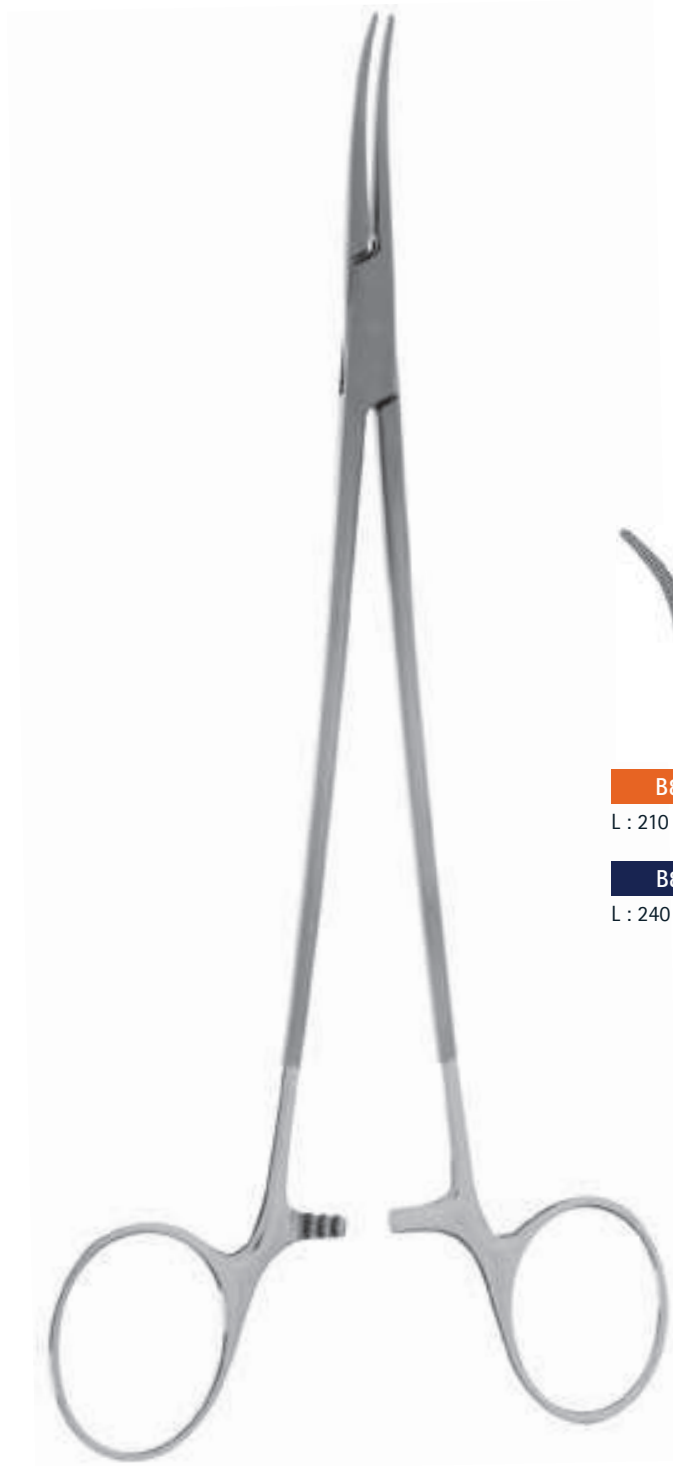

**B86560**

L : 210 mm - 8 <sup>1</sup>/<sub>3</sub> "

**B86570**

L : 240 mm - 9 <sup>1</sup>/<sub>2</sub> "

# Babcock Grasping Forceps

## Pinces à Préhension Babcock

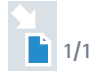

**DC46021-16**

L : 160 mm - 6 1/3 "

**DC46022-18**

L : 180 mm - 7 "

**DC46023-21**

L : 210 mm - 8 1/3 "

**DC46024-24**

L : 240 mm - 9 1/2 "



**DC46030-16**

L : 160 mm - 6 1/3 "

**DC46031-21**

L : 210 mm - 8 1/3 "



**B60400**

L : 160 mm - 6 1/3 "



**B60420**

L : 200 mm - 7 4/5 "

# Grasping Forceps Pinces à Préhension

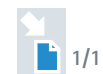

**DC46141-20**

L : 205 mm - 8 "  
Width / Largeur : 14 mm

**DC46142-20**

L : 200 mm - 7 <sup>4</sup>/<sub>5</sub> "  
Width / Largeur : 18 mm



**B65160**

L : 205 mm - 8 "

Duval



**DC40900-23**

L : 230 mm - 9 "  
Width / Largeur : 25 mm



**DC46143-20**

L : 200 mm - 7 <sup>4</sup>/<sub>5</sub> "  
Width / Largeur : 14 mm

**DC46144-23**

L : 235 mm - 9 <sup>1</sup>/<sub>4</sub> "  
Width / Largeur : 14 mm

**DC46145-20**

L : 200 mm - 7 <sup>4</sup>/<sub>5</sub> "  
Width / Largeur : 18 mm

**DC46146-23**

L : 230 mm - 9 "  
Width / Largeur : 18 mm

**DC46147-23**

L : 230 mm - 9 "  
Width / Largeur : 28 mm

# Allis Clamp Clamp Allis

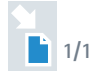

Atraumatic Jaws  
Mors Atraumatiques



**B65495**  
L : 160 mm - 6 1/3 "

**B65500**  
L : 200 mm - 7 4/5 "

Atraumatic Jaws  
Mors Atraumatiques



**DC45910-15**  
L : 155 mm - 6 "

**DC45911-20**  
L : 195 mm - 7 2/3 "

**DC45912-22**  
L : 220 mm - 8 2/3 "

**DC45913-25**  
L : 250 mm - 9 4/5 "

**DC45914-30**  
L : 300 mm - 11 4/5 "



Allis  
2 x 3 Teeth  
Griffes 2 x 3



**DC45900-15**  
L : 150 mm - 5 4/5 "

Judd Allis  
3 x 4 Teeth  
Griffes 3 x 4



**DC45901-15**  
L : 150 mm - 5 4/5 "

**DC45902-19**  
L : 190 mm - 7 1/2 "

Baby Allis  
4 x 5 Teeth  
Griffes 4 x 5



**DC45903-14**  
L : 140 mm - 5 1/2 "

**DC45904-15**  
L : 150 mm - 5 4/5 "

Allis  
5 x 6 Teeth  
Griffes 5 x 6



**DC45905-15**  
L : 150 mm - 5 4/5 "

**DC45906-19**  
L : 190 mm - 7 1/2 "

**DC45907-25**  
L : 250 mm - 9 4/5 "



# Needle Holders

## Porte-Aiguilles

### Micro Needle Holders - *Micro Porte Aiguilles*

TC Inserts  
Inserts Tungstène

Jacobson

Castroviejo

3 Articulations



P 3 - P 8



P 9 - P 14



P 15 - P 17



P 17



P 18

### Ring Handle Needle Holders - *Porte Aiguilles à Anneaux*

Paris

4 Articulations

Carpentier

Micro Ryder

Hegar

Ryder

DeBakey Fine

DeBakey

Crile Wood

Mayo Hegar



P 20



P 21



P 22



P 23



P 24



P 25



P 26



P 27



P 28



P 29



P 30



P 31



P 32



P 33

### Vascular Knot Pusher - *Pousse-Noeuds Vasculaire*



P 31

### Grasping Forceps - *Pinces à Torsader*



P 32



P 33

### Wire Cutter - *Coupe Fils*



P 34





# Micro Needle Holders

## Micro Porte-Aiguilles



Flat Handle – Width 0.3 mm – Suture from 12/0 to 8/0  
 Manche Plat – Largeur 0,3 mm – Pour Suture de 12/0 à 8/0



Straight – Without Ratchet  
 Droit – Sans Verrou

**DC50060-14**

L : 145 mm – 5 <sup>3</sup>/<sub>4</sub>''

**DC50061-18**

L : 180 mm – 7 ''

**DC50062-21**

L : 215 mm – 8 <sup>1</sup>/<sub>2</sub>''

Curved – Without Ratchet  
 Courbe – Sans Verrou

**DC50070-14**

L : 145 mm – 5 <sup>3</sup>/<sub>4</sub>''

**DC50071-18**

L : 180 mm – 7 ''

**DC50072-21**

L : 215 mm – 8 <sup>1</sup>/<sub>2</sub>''



Straight – With Ratchet  
 Droit – Avec Verrou

**DC50040-14**

L : 145 mm – 5 <sup>3</sup>/<sub>4</sub>''

**DC50041-18**

L : 180 mm – 7 ''

**DC50042-21**

L : 215 mm – 8 <sup>1</sup>/<sub>2</sub>''

Curved – With Ratchet  
 Courbe – Avec Verrou

**DC50050-14**

L : 145 mm – 5 <sup>3</sup>/<sub>4</sub>''

**DC50051-18**

L : 180 mm – 7 ''

**DC50052-21**

L : 215 mm – 8 <sup>1</sup>/<sub>2</sub>''

# Micro Needle Holders

## Micro Porte-Aiguilles



Round Handle - Width 0.3 mm - Suture from 12/0 to 8/0  
 Manche Rond - Largeur 0,3 mm - Pour Suture de 12/0 à 8/0



Straight - Without Ratchet  
 Droit - Sans Verrou

- DC50020-12  
L : 120 mm - 4 3/4"
- DC50020-14  
L : 145 mm - 5 3/4"
- DC50021-18  
L : 180 mm - 7 "
- DC50022-21  
L : 205 mm - 8 "
- DC50023-23  
L : 225 mm - 9 "



Straight - With Ratchet  
 Droit - Avec Verrou

- DC50000-12  
L : 120 mm - 4 3/4"
- DC50000-14  
L : 145 mm - 5 3/4"
- DC50001-18  
L : 180 mm - 7 "
- DC50002-21  
L : 205 mm - 8 "
- DC50003-23  
L : 225 mm - 9 "

Curved - Without Ratchet  
 Courbe - Sans Verrou

- DC50030-12  
L : 120 mm - 4 3/4"
- DC50030-14  
L : 145 mm - 5 3/4"
- DC50031-18  
L : 180 mm - 7 "
- DC50032-21  
L : 205 mm - 8 "
- DC50033-23  
L : 225 mm - 9 "

Curved - With Ratchet  
 Courbe - Avec Verrou

- DC50010-12  
L : 120 mm - 4 3/4"
- DC50010-14  
L : 145 mm - 5 3/4"
- DC50011-18  
L : 180 mm - 7 "
- DC50012-21  
L : 205 mm - 8 "
- DC50013-23  
L : 225 mm - 9 "

# Micro Needle Holders

## Micro Porte-Aiguilles

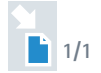

Flat Handle - Width 0.5 mm - Suture from 11/0 to 8/0  
 Manche Plat - Largeur 0,5 mm - Pour Suture de 11/0 à 8/0



Straight - Without Ratchet  
 Droit - Sans Verrou



**DC50160-14**  
 L : 145 mm - 5 3/4"

**DC50161-18**   
 L : 180 mm - 7 "

**DC50162-21**   
 L : 215 mm - 8 1/2"

Curved - Without Ratchet  
 Courbe - Sans Verrou



**DC50170-14**  
 L : 145 mm - 5 3/4"

**DC50171-18**   
 L : 180 mm - 7 "

**DC50172-21**   
 L : 215 mm - 8 1/2"



Straight - With Ratchet  
 Droit - Avec Verrou



**DC50140-14**  
 L : 145 mm - 5 3/4"

**DC50141-18**   
 L : 180 mm - 7 "

**DC50142-21**   
 L : 215 mm - 8 1/2"

Curved - With Ratchet  
 Courbe - Avec Verrou



**DC50150-14**  
 L : 145 mm - 5 3/4"

**DC50151-18**   
 L : 180 mm - 7 "

**DC50152-21**   
 L : 215 mm - 8 1/2"

# Micro Needle Holders

## Micro Porte-Aiguilles

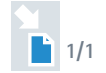

Round Handle - Width 0.5 mm - Suture from 11/0 to 8/0  
 Manche Rond - Largeur 0,5 mm - Pour Suture de 11/0 à 8/0

Straight - Without Ratchet  
 Droit - Sans Verrou



**DC50120-12**

L : 120 mm - 4 <sup>3</sup>/<sub>4</sub> "

**DC50120-14**

L : 145 mm - 5 <sup>3</sup>/<sub>4</sub> "

**DC50121-18**

L : 180 mm - 7 "

**DC50122-21**

L : 205 mm - 8 "

**DC50123-23**

L : 225 mm - 9 "

**DC50124-25**

L : 250 mm - 9 <sup>4</sup>/<sub>5</sub> "

Curved - Without Ratchet  
 Courbe - Sans Verrou

**DC50130-12**

L : 120 mm - 4 <sup>3</sup>/<sub>4</sub> "

**DC50130-14**

L : 145 mm - 5 <sup>3</sup>/<sub>4</sub> "

**DC50131-18**

L : 180 mm - 7 "

**DC50132-21**

L : 205 mm - 8 "

**DC50133-23**

L : 225 mm - 9 "

**DC50134-25**

L : 250 mm - 9 <sup>4</sup>/<sub>5</sub> "

Straight - With Ratchet  
 Droit - Avec Verrou



**DC50100-12**

L : 120 mm - 4 <sup>3</sup>/<sub>4</sub> "

**DC50100-14**

L : 145 mm - 5 <sup>3</sup>/<sub>4</sub> "

**DC50101-18**

L : 180 mm - 7 "

**DC50102-21**

L : 205 mm - 8 "

**DC50103-23**

L : 225 mm - 9 "

**DC50104-25**

L : 250 mm - 9 <sup>4</sup>/<sub>5</sub> "

Curved - With Ratchet  
 Courbe - Avec Verrou

**DC50110-12**

L : 120 mm - 4 <sup>3</sup>/<sub>4</sub> "

**DC50110-14**

L : 145 mm - 5 <sup>3</sup>/<sub>4</sub> "

**DC50111-18**

L : 180 mm - 7 "

**DC50112-21**

L : 205 mm - 8 "

**DC50113-23**

L : 225 mm - 9 "

**DC50114-25**

L : 250 mm - 9 <sup>4</sup>/<sub>5</sub> "

# Micro Needle Holders

## Micro Porte-Aiguilles

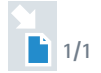

Flat Handle – Width 0.8 mm – Suture from 10/0 to 7/0  
 Manche Plat – Largeur 0,8 mm – Pour Suture de 10/0 à 7/0

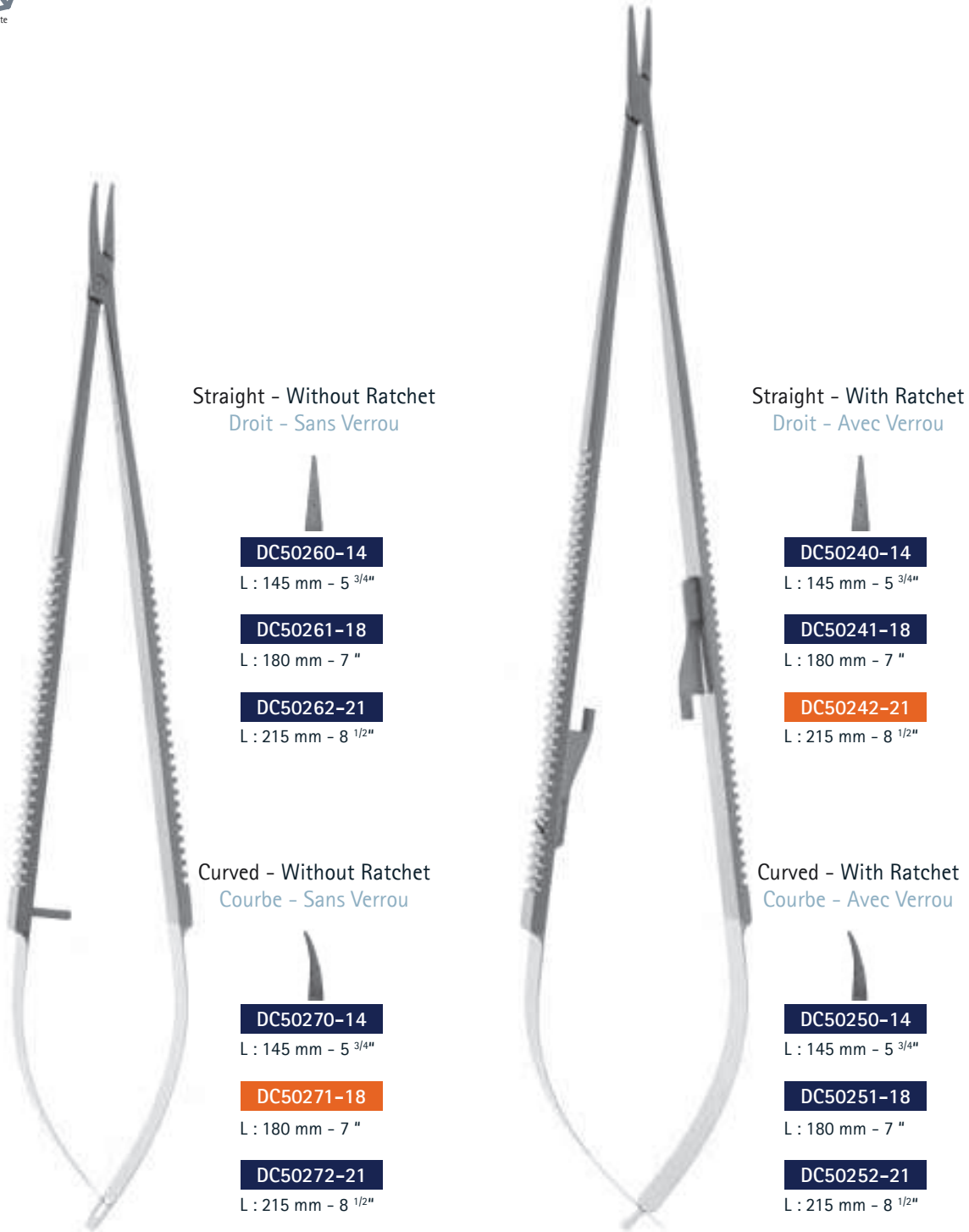

Straight - Without Ratchet  
 Droit - Sans Verrou

**DC50260-14**

L : 145 mm - 5 <sup>3</sup>/<sub>4</sub>"

**DC50261-18**

L : 180 mm - 7 "

**DC50262-21**

L : 215 mm - 8 <sup>1</sup>/<sub>2</sub>"

Straight - With Ratchet  
 Droit - Avec Verrou

**DC50240-14**

L : 145 mm - 5 <sup>3</sup>/<sub>4</sub>"

**DC50241-18**

L : 180 mm - 7 "

**DC50242-21**

L : 215 mm - 8 <sup>1</sup>/<sub>2</sub>"

Curved - Without Ratchet  
 Courbe - Sans Verrou

**DC50270-14**

L : 145 mm - 5 <sup>3</sup>/<sub>4</sub>"

**DC50271-18**

L : 180 mm - 7 "

**DC50272-21**

L : 215 mm - 8 <sup>1</sup>/<sub>2</sub>"

Curved - With Ratchet  
 Courbe - Avec Verrou

**DC50250-14**

L : 145 mm - 5 <sup>3</sup>/<sub>4</sub>"

**DC50251-18**

L : 180 mm - 7 "

**DC50252-21**

L : 215 mm - 8 <sup>1</sup>/<sub>2</sub>"

# Micro Needle Holders

## Micro Porte-Aiguilles

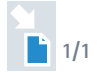

Round Handle - Width 0.8 mm - Suture from 10/0 to 7/0  
 Manche Rond - Largeur 0,8 mm - Pour Suture de 10/0 à 7/0



Straight - Without Ratchet  
 Droit - Sans Verrou

- DC50220-12  
L : 120 mm - 4 3/4"
- DC50220-14  
L : 145 mm - 5 3/4"
- DC50221-18  
L : 180 mm - 7 "
- DC50222-21  
L : 205 mm - 8 "
- DC50223-23  
L : 225 mm - 9 "



Straight - With Ratchet  
 Droit - Avec Verrou

- DC50200-12  
L : 120mm - 4 3/4"
- DC50200-14  
L : 145 mm - 5 3/4"
- DC50201-18  
L : 180 mm - 7 "
- DC50202-21  
L : 205 mm - 8 "
- DC50203-23  
L : 225 mm - 9 "

Curved - Without Ratchet  
 Courbe - Sans Verrou

- DC50230-12  
L : 120 mm - 4 3/4"
- DC50230-14  
L : 145 mm - 5 3/4"
- DC50231-18  
L : 180 mm - 7 "
- DC50232-21  
L : 205 mm - 8 "
- DC50233-23  
L : 225 mm - 9 "

Curved - With Ratchet  
 Courbe - Avec Verrou

- DC50210-12  
L : 120 mm - 4 3/4"
- DC50210-14  
L : 145 mm - 5 3/4"
- DC50211-18  
L : 180 mm - 7 "
- DC50212-21  
L : 205 mm - 8 "
- DC50213-23  
L : 225 mm - 9 "

# Micro Needle Holders

## Micro Porte-Aiguilles



Flat Handle – Smooth Jaws – Width 1.0 mm – Suture from 9/0 to 7/0  
 Manche Plat – Mors Lisses – Largeur 1,0 mm – Pour Suture de 9/0 à 7/0



Straight - Without Ratchet  
 Droit - Sans Verrou



**DC50310-14**

L : 145 mm - 5 <sup>3</sup>/<sub>4</sub>"

**DC50311-18**

L : 180 mm - 7 "

**DC50312-21**

L : 215 mm - 8 <sup>1</sup>/<sub>2</sub>"



Straight - With Ratchet  
 Droit - Avec Verrou



**DC50300-14**

L : 145 mm - 5 <sup>3</sup>/<sub>4</sub>"

**DC50301-18**

L : 180 mm - 7 "

**DC50302-21**

L : 215 mm - 8 <sup>1</sup>/<sub>2</sub>"

Curved - Without Ratchet  
 Courbe - Sans Verrou



**DC50330-14**

L : 145 mm - 5 <sup>3</sup>/<sub>4</sub>"

**DC50331-18**

L : 180 mm - 7 "

**DC50332-21**

L : 215 mm - 8 <sup>1</sup>/<sub>2</sub>"

Curved - With Ratchet  
 Courbe - Avec Verrou



**DC50320-14**

L : 145 mm - 5 <sup>3</sup>/<sub>4</sub>"

**DC50321-18**

L : 180 mm - 7 "

**DC50322-21**

L : 215 mm - 8 <sup>1</sup>/<sub>2</sub>"

# Micro Needle Holders

## Micro Porte-Aiguilles

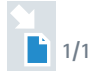

Round Handle - Smooth jaws - Width 1.0 mm - Suture from 9/0 to 7/0  
 Manche Rond - Mors Lisses - Largeur 1,0 mm - Pour Suture de 9/0 à 7/0



Straight - Without Ratchet  
 Droit - Sans Verrou

- DC50350-12**  
L : 120 mm - 4 3/4"
- DC50350-14**  
L : 145 mm - 5 3/4"
- DC50351-18**  
L : 180 mm - 7 "
- DC50352-21**  
L : 205 mm - 8 "
- DC50353-23**  
L : 225 mm - 9 "



Straight - With Ratchet  
 Droit - Avec Verrou

- DC50340-12**  
L : 120 mm - 4 3/4"
- DC50340-14**  
L : 145 mm - 5 3/4"
- DC50341-18**  
L : 180 mm - 7 "
- DC50342-21**  
L : 205 mm - 8 "
- DC50343-23**  
L : 225 mm - 9 "

Curved - Without Ratchet  
 Courbe - Sans Verrou

- DC50370-12**  
L : 120 mm - 4 3/4"
- DC50370-14**  
L : 145 mm - 5 3/4"
- DC50371-18**  
L : 180 mm - 7 "
- DC50372-21**  
L : 205 mm - 8 "
- DC50373-23**  
L : 225 mm - 9 "

Curved - With Ratchet  
 Courbe - Avec Verrou

- DC50360-12**  
L : 120 mm - 4 3/4"
- DC50360-14**  
L : 145 mm - 5 3/4"
- DC50361-18**  
L : 180 mm - 7 "
- DC50362-21**  
L : 205 mm - 8 "
- DC50363-23**  
L : 225 mm - 9 "



# Micro Needle Holders

## Micro Porte-Aiguilles

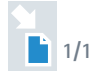

Flat Handle – Smooth Jaws – Width 1.2 mm – Suture from 9/0 to 7/0  
 Manche Plat – Mors Lisses – Largeur 1,2 mm – Pour Suture de 9/0 à 7/0



Straight – Without Ratchet  
 Droit – Sans Verrou



- DC50410-14**  
L : 145 mm - 5 3/4"
- DC50411-18**  
L : 180 mm - 7 "
- DC50412-21**  
L : 215 mm - 8 1/2"

Curved – Without Ratchet  
 Courbe – Sans Verrou



- DC50430-14**  
L : 145 mm - 5 3/4"
- DC50431-18**  
L : 180 mm - 7 "
- DC50432-21**  
L : 215 mm - 8 1/2"



Straight – With Ratchet  
 Droit – Avec Verrou



- DC50400-14**  
L : 145 mm - 5 3/4"
- DC50401-18**  
L : 180 mm - 7 "
- DC50402-21**  
L : 215 mm - 8 1/2"

Curved – With Ratchet  
 Courbe – Avec Verrou



- DC50420-14**  
L : 145 mm - 5 3/4"
- DC50421-18**  
L : 180 mm - 7 "
- DC50422-21**  
L : 215 mm - 8 1/2"

# Micro Needle Holders

## Micro Porte-Aiguilles

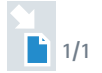

Round Handle - Smooth Jaws - Width 1.2 mm - Suture from 9/0 to 7/0  
 Manche Rond - Mors Lisses - Largeur 1,2 mm - Pour Suture de 9/0 à 7/0

	<p>Straight - Without Ratchet Droit - Sans Verrou</p>		<p>Straight - With Ratchet Droit - Avec Verrou</p>
	<p>DC50450-14 L : 145 mm - 5 3/4"</p>		<p>DC50440-14 L : 145 mm - 5 3/4"</p>
	<p>DC50451-18 L : 180 mm - 7 "</p>		<p>DC50441-18 L : 180 mm - 7 "</p>
	<p>DC50452-21 L : 205 mm - 8 "</p>		<p>DC50442-21 L : 205 mm - 8 "</p>
	<p>DC50453-23  L : 225 mm - 9 "</p>		<p>DC50443-23  L : 225 mm - 9 "</p>
	<p>Curved - Without Ratchet Courbe - Sans Verrou</p>		<p>Curved - With Ratchet Courbe - Avec Verrou</p>
	<p>DC50470-14 L : 145 mm - 5 3/4"</p>		<p>DC50460-14 L : 145 mm - 5 3/4"</p>
	<p>DC50471-18 L : 180 mm - 7 "</p>		<p>DC50461-18 L : 180 mm - 7 "</p>
<p>DC50472-21 L : 205 mm - 8 "</p>	<p>DC50462-21 L : 205 mm - 8 "</p>		
<p>DC50473-23  L : 225 mm - 9 "</p>	<p>DC50463-23  L : 225 mm - 9 "</p>		

# Micro Needle Holders

## Micro Porte-Aiguilles

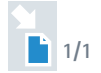

Flat Handle – Smooth Jaws – Width 1.5 mm – Suture from 8/0 to 6/0  
 Manche Plat – Mors Lisses – Largeur 1,5 mm – Suture de 8/0 à 6/0



Straight - Without Ratchet  
Droit - Sans Verrou



**DC50510-14**

L : 145 mm - 5 3/4"

**DC50511-18**

L : 180 mm - 7 "

**DC50512-21**

L : 215 mm - 8 1/2"

Straight - With Ratchet  
Droit - Avec Verrou



**DC50500-14**

L : 145 mm - 5 3/4"

**DC50501-18**

L : 180 mm - 7 "

**DC50502-21**

L : 215 mm - 8 1/2"

Curved - Without Ratchet  
Courbe - Sans Verrou



**DC50530-14**

L : 145 mm - 5 3/4"

**DC50531-18**

L : 180 mm - 7 "

**DC50532-21**

L : 215 mm - 8 1/2"

Curved - With Ratchet  
Courbe - Avec Verrou



**DC50520-14**

L : 145 mm - 5 3/4"

**DC50521-18**

L : 180 mm - 7 "

**DC50522-21**

L : 215 mm - 8 1/2"

# Micro Needle Holders

## Micro Porte-Aiguilles

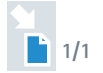

Round Handle - Smooth Jaws - Width 1.5 mm - Suture from 8/0 to 6/0  
 Manche Rond - Mors Lisses - Largeur 1,5 mm - Suture de 8/0 à 6/0



Straight - Without Ratchet  
 Droit - Sans Verrou



- DC50550-14**  
L : 145 mm - 5 3/4"
- DC50551-18**  
L : 180 mm - 7 "
- DC50552-21**  
L : 205 mm - 8 "
- DC50553-23**  
L : 225 mm - 9 "

Straight - With Ratchet  
 Droit - Avec Verrou



- DC50540-14**  
L : 145 mm - 5 3/4"
- DC50541-18**  
L : 180 mm - 7 "
- DC50542-21**  
L : 205 mm - 8 "
- DC50543-23**  
L : 225 mm - 9 "

Curved - Without Ratchet  
 Courbe - Sans Verrou



- DC50570-14**  
L : 145 mm - 5 3/4"
- DC50571-18**  
L : 180 mm - 7 "
- DC50572-21**  
L : 205 mm - 8 "
- DC50573-23**  
L : 225 mm - 9 "

Curved - With Ratchet  
 Courbe - Avec Verrou



- DC50560-14**  
L : 145 mm - 5 3/4"
- DC50561-18**  
L : 180 mm - 7 "
- DC50562-21**  
L : 205 mm - 8 "
- DC50563-23**  
L : 225 mm - 9 "

# Heavy Style Jacobson Micro Needle Holders

## Micro Porte-Aiguilles Jacobson - Modèle Fort



Round Handle - Ø 10 mm  
Manche Rond - Ø 10 mm

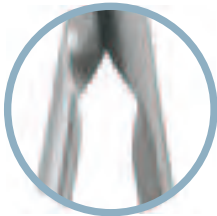

Streamline Design



Straight - Without Ratchet  
Droit - Sans Verrou



**DC50631-19**

L : 190 mm - 7 1/2"

**DC50635-23**

L : 230 mm - 9"

**DC50641-25**

L : 250 mm - 10"



Straight - With Ratchet  
Droit - Avec Verrou



**DC50630-19**

L : 190 mm - 7 1/2"

**DC50634-23**

L : 230 mm - 9"

**DC50640-25**

L : 250 mm - 10"

Curved - Without Ratchet  
Courbe - Sans Verrou



**DC50633-19**

L : 190 mm - 7 1/2"

**DC50637-23**

L : 230 mm - 9"

**DC50643-25**

L : 250 mm - 10"

Curved - With Ratchet  
Courbe - Avec Verrou



**DC50632-19**

L : 190 mm - 7 1/2"

**DC50636-23**

L : 230 mm - 9"

**DC50642-25**

L : 250 mm - 10"

# Jacobson Micro Needle Holders

## Micro Porte-Aiguilles Jacobson

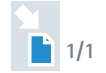

Round Handle - Width 1.2 mm - Suture from 9/0 to 8/0  
 Manche Rond - Largeur 1,2 mm - Suture de 9/0 à 8/0



Straight - Without Ratchet  
 Droit - Sans Verrou

- 

**DC50611-18**   
 L : 180 mm - 7 "
- 

**DC50611-21**   
 L : 210 mm - 8 "
- 

**DC50611-23**   
 L : 230 mm - 9 "
- 

**DC50611-25**   
 L : 250 mm - 10 "



Straight - With Ratchet  
 Droit - Avec Verrou

- 

**DC50610-18**   
 L : 180 mm - 7 "
- 

**DC50610-21**   
 L : 210 mm - 8 "
- 

**DC50610-23**   
 L : 230 mm - 9 "
- 

**DC50610-25**   
 L : 250 mm - 10 "



Curved - Without Ratchet  
 Courbe - Sans Verrou

- 

**DC50613-18**   
 L : 180 mm - 7 "
- 

**DC50613-21**   
 L : 210 mm - 8 "
- 

**DC50613-23**   
 L : 230 mm - 9 "
- 

**DC50613-25**   
 L : 250 mm - 10 "



Curved - With Ratchet  
 Courbe - Avec Verrou

- 

**DC50612-18**   
 L : 180 mm - 7 "
- 

**DC50612-21**   
 L : 210 mm - 8 "
- 

**DC50612-23**   
 L : 230 mm - 9 "
- 

**DC50612-25**   
 L : 250 mm - 10 "

# Micro Needle Holders

## Micro Porte-Aiguilles

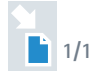

Suture from 10/0 to 8/0  
Suture de 10/0 à 8/0

### Jacobson

Rings Handle  
À Anneaux

Straight - With Ratchet  
Droit - Avec Verrou



**DC50614-18**

L : 185 mm - 7 1/4"



**DC50616-23**

L : 230 mm - 9"

### Castroviejo

Straight - With Ratchet  
Droit - Avec Verrou



**DC50661-14**

L : 140 mm - 5 1/2"

Curved  
Courbe



**DC50662-14**

L : 140 mm - 5 1/2"

Straight - Without Ratchet  
Droit - Sans Verrou



**DC50663-14**

L : 140 mm - 5 1/2"

Curved  
Courbe



**DC50664-14**

L : 140 mm - 5 1/2"



# 3 Articulations Micro Needle Holders

## Micro Porte-Aiguilles 3 Articulations

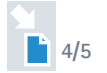

Diamonte



Counterbalanced

Counterbalanced - Width 1.0 mm - Suture from 10/0 to 8/0  
 Contrebalancé - Largeur 1,0 mm - Suture de 10/0 à 8/0



Straight - Without Ratchet  
 Droit - Sans Verrou

**DC50621-23**

L : 230 mm - 9 "

Curved - Without Ratchet  
 Courbe - Sans Verrou

**DC50623-23**

L : 230 mm - 9 "



Straight - With Ratchet  
 Droit - Avec Verrou

**DC50620-23**

L : 230 mm - 9 "

Curved - With Ratchet  
 Courbe - Avec Verrou

**DC50622-23**

L : 230 mm - 9 "



# Pitch of Ring Handle Needle Holders

## Denture des Porte-Aiguilles à Anneaux

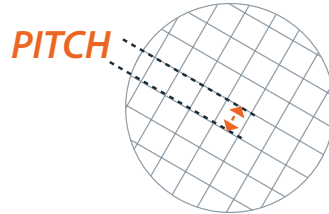
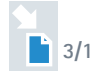

Pitch 0.3 mm

DC51100-15	DC51120-15
DC51100-18	DC51120-18
DC51100-20	DC51120-20
DC51100-23	DC51120-23
DC51110-13	DC51140-18
DC51110-15	DC51140-20
DC51110-18	DC51140-23
DC51110-20	DC51140-26
DC51110-23	DC51140-30
DC51110-26	



Pitch 0.4 mm

DC51000-23	DC51150-20
DC51010-24	DC51150-23
DC51010-27	DC51150-26
DC51011-24	DC51150-30
DC51011-27	DC51160-15
DC51130-13	DC51160-18
DC51130-15	DC51160-20
DC51130-18	DC51160-23
DC51130-20	DC51160-26
DC51130-23	DC51160-30
DC51130-26	G306300
DC51150-18	G30640



Pitch 0.5 mm

DC51012-24	DC51170-26
DC51012-27	DC51170-30
DC51170-16	DC51171-20
DC51170-18	DC51171-24
DC51170-20	DC51171-26
DC51170-24	

# Paris Delicate Needle Holders

## Porte-Aiguilles Délicats Paris

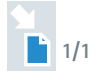

Suture from 11/0 to 6/0  
Suture de 11/0 à 6/0



Fine - Width 1.0 mm  
Fin - Largeur 1.0 mm

Large - Width 1.5 mm  
Large - Largeur 1.5 mm

- DC51050-18**  
L : 185 mm - 7 "
- DC51050-20**  
L : 205 mm - 8 "
- DC51050-22**  
L : 225 mm - 9 "

- DC51060-18**  
L : 185 mm - 7 "
- DC51060-20**  
L : 205 mm - 8 "
- DC51060-22**  
L : 225 mm - 9 "

# 4 Articulations Needle Holders

## Porte-Aiguilles 4 Articulations

4/5



### Mayo Hegar

Pitch 0.5 mm - Suture from 4/0 to 1/0

Pitch 0,5 mm - Pour Suture de 4/0 à 1/0



DC51012-24

L : 240 mm - 9 1/2"

DC51012-27

L : 270 mm - 10 1/2"

### DeBakey

Pitch 0.4 mm - Suture from 6/0 to 4/0

Pitch 0,4 mm - Pour Suture de 6/0 à 4/0



DC51011-24

L : 240 mm - 9 1/2"

DC51011-27

L : 270 mm - 10 1/2"

### Ryder

Pitch 0.4 mm - Suture from 6/0 to 4/0

Pitch 0,4 mm - Pour Suture de 6/0 à 4/0



DC51010-24

L : 240 mm - 9 1/2"

DC51010-27

L : 270 mm - 10 1/2"



# Carpentier Needle Holders

## Porte-Aiguilles Carpentier

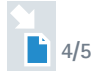

Pitch 0.4 mm - Suture from 6/0 to 4/0  
Pitch 0,4 mm - Pour Suture de 6/0 à 4/0



DC51000-23

L : 230 mm - 9 "

# Micro Vascular Needle Holders

## Porte-Aiguilles Micro Vasculaire

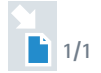

Pitch 0.3 mm - Suture from 8/0 to 5/0  
Pitch 0,3 mm - Pour Suture de 8/0 à 5/0



**DC51100-15**

L : 150 mm - 6 "

**DC51100-18**

L : 180 mm - 7 "

**DC51100-20**

L : 200 mm - 8 "

**DC51100-23**

L : 230 mm - 9 "



# Micro Ryder Needle Holders

## Porte-Aiguilles Micro Ryder



Pitch 0.3 mm - Suture from 8/0 to 5/0

Pitch 0,3 mm - Pour Suture de 8/0 à 5/0



**DC51110-13**

L : 130 mm - 5 "

**DC51110-15**

L : 150 mm - 6 "

**DC51110-18**

L : 180 mm - 7 "

**DC51110-20**

L : 200 mm - 8 "

**DC51110-23**

L : 230 mm - 9 "

**DC51110-26**

L : 260 mm - 10 "

# Hegar Needle Holders

## Porte-Aiguilles Hegar

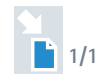

Pitch 0.3 mm - Suture from 9/0 to 7/0

Pitch 0,3 mm - Pour Suture de 9/0 à 7/0



**DC51120-15**

L : 150 mm - 6 "

**DC51120-18**

L : 180 mm - 7 "

**DC51120-20**

L : 200 mm - 8 "

**DC51120-23**

L : 230 mm - 9 "



# Ryder Needle Holders

## Porte-Aiguilles Ryder

Pitch 0.4 mm - Suture from 6/0 to 4/0

Pitch 0,4 mm - Suture de 6/0 à 4/0



**DC51130-13**

L : 130 mm - 5 "

**DC51130-15** 

L : 150 mm - 6 "

**DC51130-18** 

L : 180 mm - 7 "

**DC51130-20**

L : 200 mm - 8 "

**DC51130-23**

L : 230 mm - 9 "

**DC51130-26**

L : 260 mm - 10 "



# DeBakey Fine Needle Holders

## Porte-Aiguilles DeBakey Fin

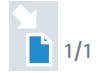

Pitch 0.3 mm - Suture from 7/0 to 5/0  
Pitch 0,3 mm - Suture de 7/0 à 5/0



**DC51140-18**

L : 180 mm - 7 "

**DC51140-20**

L : 200 mm - 8 "

**DC51140-23**

L : 230 mm - 9 "

**DC51140-26**

L : 260 mm - 10 "

**DC51140-30**

L : 300 mm - 12 "



# DeBakey Needle Holders

## Porte-Aiguilles DeBakey



Pitch 0.4 mm - Suture from 6/0 to 4/0

Pitch 0,4 mm - Suture de 6/0 à 4/0



**DC51150-18**

L : 180 mm - 7 "

**DC51150-20**

L : 200 mm - 8 "

**DC51150-23**

L : 230 mm - 9 "

**DC51150-26**

L : 260 mm - 10 "

**DC51150-30**

L : 300 mm - 12 "

# Crile Wood Needle Holders

## Porte-Aiguilles Crile Wood

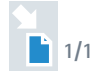

Pitch 0.4 mm - Suture from 5/0 to 3/0  
Pitch 0,4 mm - Suture de 5/0 à 3/0



**DC51160-15**

L : 150 mm - 6 "

**DC51160-18**

L : 180 mm - 7 "

**DC51160-20**

L : 200 mm - 8 "

**DC51160-23**

L : 230 mm - 9 "

**DC51160-26**

L : 260 mm - 10 "

**DC51160-30**

L : 300 mm - 12 "



# Mayo Hegar Needle Holders

## Porte-Aiguilles Mayo Hegar

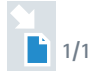

Pitch 0.5 mm - Suture from 4/0 to 1/0  
Pitch 0,5 mm - Suture de 4/0 à 1/0



Straight  
Droit

**DC51170-16**

L : 160 mm - 6 1/4"

**DC51170-18**

L : 180 mm - 7 "

**DC51170-20**

L : 200 mm - 8 "

**DC51170-24**

L : 240 mm - 9 1/2"

**DC51170-26**

L : 260 mm - 10 "

**DC51170-30**

L : 300 mm - 12 "

Curved  
Courbe

**DC51171-20**

L : 200 mm - 8 "

**DC51171-24**

L : 240 mm - 9 1/2"

**DC51171-26**

L : 260 mm - 10 "

# Vascular Knot Pusher

## Pousse-Noeuds Vasculaire

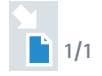

1/1



Scale - Échelle : 4/1



DC71700-24

L : 240 mm - 9 1/2"

# Grasping Forceps for Cerclage Thread

## Pincers à Torsader les Fils

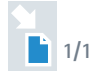

Sternum



- DC51180-15**  
L : 150 mm - 6 "
- DC51180-18**  
L : 180 mm - 7 "
- DC51180-20**  
L : 200 mm - 8 "

# Grasping Forceps for Cerclage Thread

## Pinces à Torsader les Fils

Catalogue Landanger  
Chap. VI

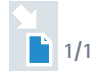

**G306300**  
L : 150 mm - 6 "

**G30640**  
L : 190 mm - 7 1/2"

# Wire Cutter Coupe Fils

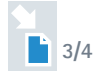

Catalogue Landanger  
Chap. XIV



Ø Max : 2.5 mm

Ø Max : 1.7 mm



**J758200**  
L : 180 mm - 7 "



**J758300**  
L : 240 mm - 8 3/4 "



# Osseous

## Osseux



### Rib Shears - *Costotomes*

Maurer



P 3

### Raspatories - *Rugines*

Ollier Doyen Maurer



P 4

P 5

### Bone Rongeur Forceps - *Pinces Gouges*

Lempert Lombard Vincent Sicart Luer Friedmann Mini Friedmann Luer



P 6

P 7

P 10

P 13

P 14

### Bone Rongeur Forceps 4 Articulations - *Pinces Gouges 4 Articulations*

Stille Echlin Smith-Petersen Leksell-Stille Bohler Beyer



P 8

P 9

P 11

P 12



# Osseous Osseux

## Bone Cutting Forceps - *Pinces Coupantes*

Liston



P 15

P 16

## Bone Cutting Forceps 4 Articulations - *Pinces Coupantes 4 Articulations*

Bohler

Mac Indoe

Ruskin Liston

Liston



P 17

P 18

P 19

P 20

# Maurer Rib Shears

## Costotome Maurer

Catalogue Landanger  
Chap. XIII

2/3



Double Collin's Lock  
Articulation à Double Doigt



**J68220**

L : 310 mm - 12 " - Left Curved / Courbe à Gauche

**J68210**

L : 310 mm - 12 " - Right Curved / Courbe à Droite

With Screw  
À Vis



**J68230**

L : 240 mm - 9 1/2 " - Left Curved / Courbe à Gauche

**J68240**

L : 240 mm - 9 1/2 " - Right Curved / Courbe à Droite

# Raspatories Rugines

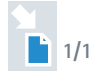

Catalogue Landanger  
Chap. XIII



## Ollier

## Doyen

Concave  
Concave

Convex  
Convexe

Right  
Droite

Left  
Gauche

Right  
Droite



J24160

J24150

J24140

J24170

J24180

L : 160 mm - 6 1/4 "  
Width / Largeur : 10 mm

L : 160 mm - 6 1/4 "  
Width / Largeur : 10 mm

L : 160 mm - 6 1/4 "  
Width / Largeur : 10 mm

L : 160 mm - 6 1/4 "

J241810

L : 240 mm - 9 1/2 "

L : 160 mm - 6 1/4 "

J241811

L : 240 mm - 9 1/2 "

# Maurer Raspatories

## Rugines Maurer

Catalogue Landanger  
Chap. XIII

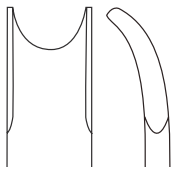
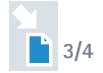

**J24280**

L : 260 mm - 10 " - Forked / Fourchu  
Width / Largeur : 12 mm



**J24282**

L : 260 mm - 10 " - Straight / Droit  
Width / Largeur : 6 mm

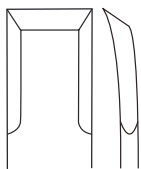

**J24284**

L : 260 mm - 10 " - Straight / Droit  
Width / Largeur : 12 mm

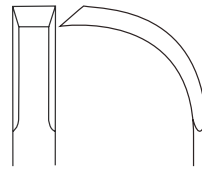

**J24290**

L : 260 mm - 10 " - Curved / Courbe  
Width / Largeur : 6 mm

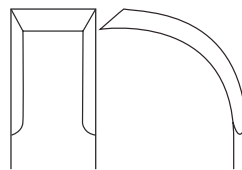

**J24300**

L : 260 mm - 10 " - Curved / Courbe  
Width / Largeur : 12 mm

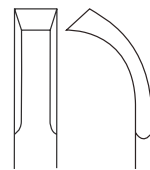

**J24310**

L : 260 mm - 10 " - Half Curved / Semi-courbe  
Width / Largeur : 6 mm

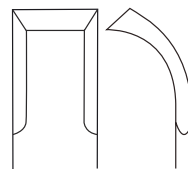

**J24320**

L : 260 mm - 10 " - Half Curved / Semi-courbe  
Width / Largeur : 12 mm

# Bone Rongeur Forceps Pincers Gouges

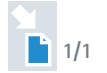

Catalogue Landanger  
Chap. XIII



Lempert



Straight  
Droit



**J64190**

L : 190 mm - 7 1/2 "  
Width / Largeur : 3 mm

Curved  
Courbe



**J64192**

L : 190 mm - 7 1/2 "  
Width / Largeur : 3 mm

Lombard

Double Collin's Lock  
Articulation à Double Doigt



Angled  
Coudé

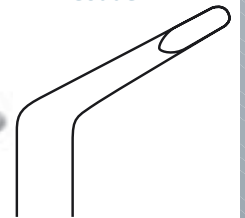

**J64260**

L : 180 mm - 7 "

# Bone Rongeur Forceps

## Pinces Gouges

Catalogue Landanger  
Chap. XIII

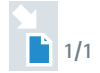

### Double Collin's Lock Articulation à Double Doigt



**J64020**

L : 170 mm - 6 <sup>3</sup>/<sub>4</sub> " - Straight / Droit  
Width / Largeur : 5 mm



**J64030**

L : 170 mm - 6 <sup>3</sup>/<sub>4</sub> " - Straight / Droit  
Width / Largeur : 7 mm



**J64090**

L : 200 mm - 7 <sup>4</sup>/<sub>5</sub> " - Straight / Droit  
Width / Largeur : 8 mm



**J64040**

L : 170 mm - 6 <sup>3</sup>/<sub>4</sub> " - Straight / Droit  
Width / Largeur : 9 mm



**J64100**

L : 200 mm - 7 <sup>4</sup>/<sub>5</sub> " - Straight / Droit  
Width / Largeur : 10 mm



**J64060**

L : 170 mm - 6 <sup>3</sup>/<sub>4</sub> " - Curved / Courbe  
Width / Largeur : 5 mm

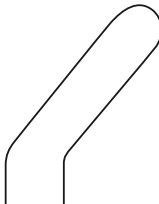

**J64070**

L : 170 mm - 6 <sup>3</sup>/<sub>4</sub> " - Curved / Courbe  
Width / Largeur : 7 mm



**J64120**

L : 200 mm - 7 <sup>4</sup>/<sub>5</sub> " - Curved / Courbe  
Width / Largeur : 8 mm

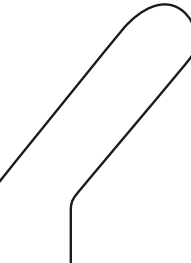

**J64080**

L : 170 mm - 6 <sup>3</sup>/<sub>4</sub> " - Curved / Courbe  
Width / Largeur : 9 mm



**J64130**

L : 200 mm - 7 <sup>4</sup>/<sub>5</sub> " - Curved / Courbe  
Width / Largeur : 10 mm

# Stille Bone Rongeur Forceps Pincers Gouges Stille

Catalogue Landanger  
Chap. XIII

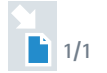

4 Articulations



Straight  
Droit



**J64200**

L : 230 mm - 9 "  
Width / Largeur : 6 mm



**J64210**

L : 230 mm - 9 "  
Width / Largeur : 8 mm

Angled  
Coudé



**J64220**

L : 230 mm - 9 "  
Width / Largeur : 6 mm



**J64230**

L : 230 mm - 9 "  
Width / Largeur : 8 mm

Curved  
Courbe



**J64240**

L : 230 mm - 9 "  
Width / Largeur : 6 mm



**J64250**

L : 230 mm - 9 "  
Width / Largeur : 8 mm



# Echlin Bone Rongeur Forceps

## Pinces Gouges Echlin

Catalogue Landanger  
Chap. XIII

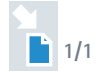

4 Articulations

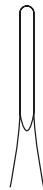

J64254

L : 230 mm - 9 " - 2 x 10 mm



J64256

L : 230 mm - 9 " - 3 x 10 mm

# Bone Rongeur Forceps

## Pincers Gouges

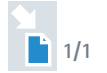

Catalogue Landanger  
Chap. XIII



Double Collin's Lock  
Articulation à Double Doigt

Vincent



Angled Short Jaws  
Mors Courts Coudés

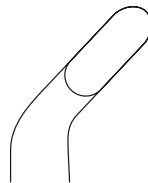

**J64310**  
L : 200 mm - 7 <sup>3</sup>/<sub>4</sub> "

**J64350**  
L : 240 mm - 9 <sup>1</sup>/<sub>2</sub> "

Sicart



Angled Long Jaws  
Mors Longs Coudés



**J64290**  
L : 200 mm - 7 <sup>3</sup>/<sub>4</sub> "

**J64330**  
L : 240 mm - 9 <sup>1</sup>/<sub>2</sub> "

**J64380**  
L : 230 mm - 9 "

# Bone Rongeur Forceps

## Pinces Gouges

Catalogue Landanger  
Chap. XIII

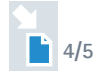

4 Articulations

### Smith-Petersen



Curved  
Courbe



**J64412**

L : 190 mm - 7 1/2 "  
Width / Largeur : 4 mm

**J64414**

L : 230 mm - 9 "  
Width / Largeur : 4 mm

### Leksell-Stille



Curved  
Courbe



**J64416**

L : 240 mm - 9 1/2 "  
Width / Largeur : 3 mm

**J64418**

L : 240 mm - 9 1/2 "  
Width / Largeur : 5 mm

**J64422**

L : 240 mm - 9 1/2 "  
Width / Largeur : 8 mm

# Bone Rongeur Forceps Pincers Gouges

Catalogue Landanger  
Chap. XIII

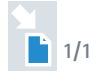

4 Articulations



Bohler



Straight  
Droit



J64384

L : 150 mm - 6 "  
Width / Largeur : 3 mm

Curved  
Courbe



J64386

L : 150 mm - 6 "  
Width / Largeur : 3 mm

J643850

L : 150 mm - 6 "  
Width / Largeur : 2 mm

Beyer



Curved  
Courbe

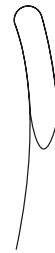

J64390

L : 180 mm - 7 "  
4 x 15 mm

J64410

L : 200 mm - 7 3/4 "  
6 x 16 mm

Curved  
Courbe



J643950

L : 180 mm - 7 "  
Width / Largeur : 2,5 mm

# Bone Rongeur Forceps

## Pinces Gouges

Catalogue Landanger  
Chap. XIII

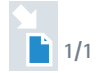

### Luer Friedmann



**J64400**  
L : 140 mm - 5 1/2 "  
Width / Largeur : 2 mm

### Mini Friedmann



**J644005**  
L : 125 mm - 4 3/4 "  
Width / Largeur : 2,5 mm

# Luer Bone Rongeur Forceps

## Pincers Gouges Luer

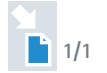

Catalogue Landanger  
Chap. XIII



Straight  
Droit



**J644950**

L : 170 mm - 6 <sup>3</sup>/<sub>4</sub> "  
Width / Largeur : 8 mm

**J644970**

L : 185 mm - 7 <sup>1</sup>/<sub>3</sub> "  
Strong / Modèle Fort

Curved  
Courbe



**J64490**

L : 150 mm - 6 "  
Width / Largeur : 4 mm

**J644960**

L : 170 mm - 6 <sup>3</sup>/<sub>4</sub> "  
Width / Largeur : 8 mm

**J644980**

L : 185 mm - 7 <sup>1</sup>/<sub>3</sub> "  
Strong / Modèle Fort

# Liston Bone Cutting Forceps

## Pinces Coupantes Liston

Catalogue Landanger  
Chap. XIII

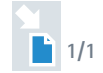

Straight  
Droit



**J68022**

L : 140 mm - 5 1/2 "

**J68026**

L : 170 mm - 6 3/4 "

**J68030**

L : 190 mm - 7 1/2 "

**J68050**

L : 220 mm - 8 3/4 "

Angled  
Coudé



**J68024**

L : 140 mm - 5 1/2 "

**J68028**

L : 170 mm - 6 3/4 "

**J68040**

L : 190 mm - 7 1/2 "

**J68060**

L : 220 mm - 8 3/4 "

# Liston Bone Cutting Forceps

## Pincers Coupantes

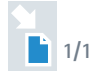

Catalogue Landanger  
Chap. XIII



Double Collin's Lock  
Articulation à Double Doigt



Straight  
Droit



**J68062**

L : 190 mm - 7 1/2 "

**J68066**

L : 220 mm - 8 3/4 "

Angled  
Coudé



**J68064**

L : 190 mm - 7 1/2 "

**J68068**

L : 220 mm - 8 3/4 "



# Bone Cutting Forceps

## Pinces Coupantes

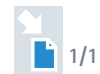

Catalogue Landanger  
Chap. XIII



4 Articulations

Bohler

Mac Indoe



Straight  
Droit



J68010

L : 150 mm - 6 "

Angled  
Coudé



J68012

L : 150 mm - 6 "

Angled  
Coudé



J68015

L : 170 mm - 6 <sup>3</sup>/<sub>4</sub> "

J68020

L : 190 mm - 7 <sup>1</sup>/<sub>2</sub> "



# Ruskin Liston Bone Cutting Forceps

## Pinces Coupantes Ruskin Liston

Catalogue Landanger  
Chap. XIII

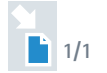

4 Articulations



Straight  
Droit



J68275

L : 190 mm - 7 1/2 "

Angled  
Coudé



J68280

L : 190 mm - 7 1/2 "

# Liston Bone Cutting Forceps

## Pinces Coupantes Liston

Catalogue Landanger  
Chap. XIII

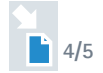

4 Articulations



Straight  
Droit



**J68090**

L : 240 mm - 9 1/2 "

Angled  
Coudé



**J68100**

L : 240 mm - 9 1/2 "

# Liston Bone Cutting Forceps

## Pincers Coupantes Liston

Catalogue Landanger  
Chap. XIII

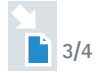

4 Articulations

Counterbent - Strong  
Contre-coudée - Forte

Curved - Strong  
Courbe - Forte



J68110  
L : 280 mm - 11 "



J68120  
L : 280 mm - 11 "

# Special Spéciaux



## Suture Passer - Tire-Fils

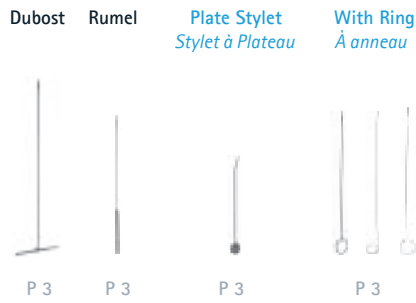

## Vein Holder - Chausse Veine



## Coronary Testers - Testeurs Coronariens

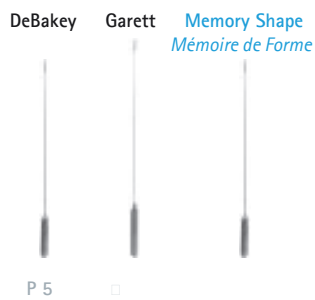

## Aortic Punch - Punch Aortique



## Haemostatic System - Système Hémostatique



## Suction Tubes - Canules d'aspiration

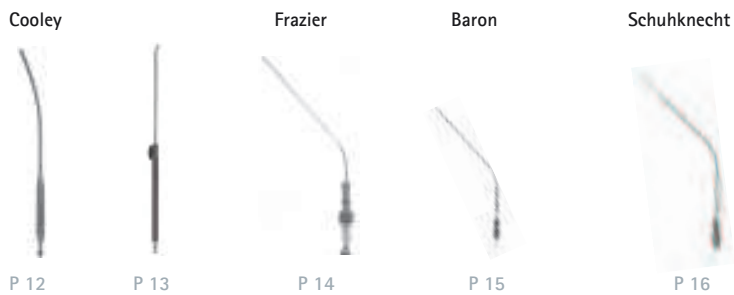



# Special Spéciaux

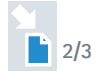

Heparine Needles - *Aiguilles héparines*

Aortic Purge - *Purge Aortique*

Tubing Clamp - *Presse tube*

□



P 8



P 17



P 18

Instruments Holder - *Porte Instruments*

Surgical Articulated Arm - *Bras Chirurgical Articulé*

**Lortat Jacob**

**Endoboy**



P 19



P 20

# Suture Passer

## Tire-Fils

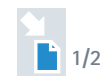

Dubost Stylet  
Stylet Dubost



**DC70500-00**  
L : 330 mm - 13 "

Rumel Stylet  
Stylet Rumel



**DC70600-00**  
L : 170 mm - 6 3/4 "

**DC70600-01**  
L : 190 mm - 7 1/2 "

With Ring  
À Anneau



**DC70800-26**  
L : 260 mm - 10 "

Plate stylet  
Stylet à Plateau



**DC70700-00**

With Ring  
À Anneau



**DC70810-26**  
L : 260 mm - 10 "

With Ring  
À Anneau



**DC70820-26**  
L : 265 mm - 10 2/5 "

# Kienny Vein Holder

## Chausse Veine Kienny

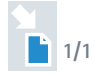

**B80330**  
L : 170 mm - 6 <sup>3</sup>/<sub>4</sub> "



# Coronary Dilators

## Testeurs Coronariens

### DeBakey

### Garrett

### Memory Shape Mémoire de Forme

Ø : 0,5 mm

DC71410-05

L : 190 mm - 7 1/2 "

DC71420-05

L : 140 mm - 5 1/2 "

DC71430-05

L : 210 mm - 8 1/3 "

DC71440-05

L : 140 mm - 5 1/2 "

DC71450-05

L : 210 mm - 8 1/3 "

Ø : 1 mm

DC71410-10

L : 190 mm - 7 1/2 "

DC71420-10

L : 140 mm - 5 1/2 "

DC71430-10

L : 210 mm - 8 1/3 "

DC71440-10

L : 140 mm - 5 1/2 "

DC71450-10

L : 210 mm - 8 1/3 "

Ø : 1,5 mm

DC71410-15

L : 190 mm - 7 1/2 "

DC71420-15

L : 140 mm - 5 1/2 "

DC71430-15

L : 210 mm - 8 1/3 "

DC71440-15

L : 140 mm - 5 1/2 "

DC71450-15

L : 210 mm - 8 1/3 "

Ø : 2 mm

DC71410-20

L : 190 mm - 7 1/2 "

DC71420-20

L : 140 mm - 5 1/2 "

DC71430-20

L : 210 mm - 8 1/3 "

DC71440-20

L : 140 mm - 5 1/2 "

DC71450-20

L : 210 mm - 8 1/3 "

Ø : 2,5 mm

DC71410-25

L : 190 mm - 7 1/2 "

DC71420-25

L : 140 mm - 5 1/2 "

DC71430-25

L : 210 mm - 8 1/3 "

DC71440-25

L : 140 mm - 5 1/2 "

DC71450-25

L : 210 mm - 8 1/3 "

Ø : 3 mm

DC71410-30

L : 190 mm - 7 1/2 "

DC71420-30

L : 140 mm - 5 1/2 "

DC71430-30

L : 210 mm - 8 1/3 "

DC71440-30

L : 140 mm - 5 1/2 "

DC71450-30

L : 210 mm - 8 1/3 "

Ø : 3,5 mm

DC71410-35

L : 190 mm - 7 1/2 "

DC71420-35

L : 140 mm - 5 1/2 "

DC71430-35

L : 210 mm - 8 1/3 "

DC71440-35

L : 140 mm - 5 1/2 "

DC71450-35

L : 210 mm - 8 1/3 "

Ø : 4 mm

DC71410-40

L : 190 mm - 7 1/2 "

DC71420-40

L : 140 mm - 5 1/2 "

DC71430-40

L : 210 mm - 8 1/3 "

DC71440-40

L : 140 mm - 5 1/2 "

DC71450-40

L : 210 mm - 8 1/3 "

Ø : 4,5 mm

DC71410-45

L : 190 mm - 7 1/2 "

DC71420-45

L : 140 mm - 5 1/2 "

DC71430-45

L : 210 mm - 8 1/3 "

DC71440-45

L : 140 mm - 5 1/2 "

DC71450-45

L : 210 mm - 8 1/3 "

Ø : 5 mm

DC71410-50

L : 190 mm - 7 1/2 "

DC71420-50

L : 140 mm - 5 1/2 "

DC71430-50

L : 210 mm - 8 1/3 "

DC71440-50

L : 140 mm - 5 1/2 "

DC71450-50

L : 210 mm - 8 1/3 "

Ø : 7 mm

DC71410-70

L : 190 mm - 7 1/2 "

Ø : 9 mm

DC71410-90

L : 190 mm - 7 1/2 "

# Aortic Punch

## Punch Aortique

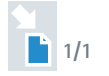

**DC72300-04**

Ø : 4,0 mm

**DC72301-04**

Ø : 4,5 mm

**DC72302-05**

Ø : 5,0 mm

# Coronary Haemostatic System Système Hémostatique Coronaire

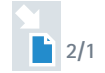

DC71600-12

L : 30 mm

Maximum Opening / Ouverture Maximale : 20 mm

# Heparine Needle Set

## Canules à Héparine

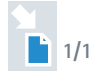

**DC70400-15** 3 needles set / Jeu de 3 aiguilles

Ø : 1,5 mm

**DC70400-25** 3 needles set / Jeu de 3 aiguilles

Ø : 2,5 mm

# Pool Suction Tubes

## Canules d'Aspiration Pool

4/5

With Removable Tip  
À Embout Démontable



DC71320-08

L : 245 mm - 9 " - Curved / Courbe

External / Externe : Ø 8 mm



DC71321-08

L : 245 mm - 9 " - Straight / Droit

External / Externe : Ø 8 mm

# Suction Tubes Canules d'Aspiration

## Baby Yankauer

With Removable Tip  
À Embout Démontable

Scale - Échelle : 2/1



DC71320-02

Tube L : 110 mm  
Total L : 210 mm  
Ø : 1,8 mm

## Andrews-Pynchon

Scale - Échelle : 2/1



DC71310-02

Tube L : 100 mm  
Total L : 240 mm  
Ø : 2 mm

## Yankauer

With Removable Tip  
Male Luer Connector  
À Embout Démontable  
Connecteur Mâle Luer

Scale - Échelle : 2/1



DC71300-02

Tube L : 160 mm  
Total L : 300 mm  
Ø : 2 mm

DC71300-05

Tube L : 160 mm  
Total L : 300 mm  
Ø : 4,8 mm

# DeBakey Suction Tube

## Canule d'Aspiration DeBakey

With Removable Tip - Male Luer Connector  
À Embout Démontable - Connecteur Mâle Luer

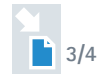

3/4



Scale - Échelle : 2/1



DC71330-03

L : 320 mm - 12 <sup>3</sup>/<sub>5</sub> " - Curved / Courbe  
Ø : 3 mm

# Cooley Suction Tubes

## Canules d'Aspiration Cooley

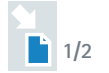

With Suction Control Handle  
Contrôle Manuel de l'Aspiration



**DC71340-10**

Tube L : 130 mm - 5 "  
90° - Ø : 9,0 mm

**DC71340-09**

Tube L : 180 mm - 7 "  
Curved / Courbe  
Ø : 9,0 mm

**DC71340-08**

Tube L : 180 mm - 7 "  
Curved / Courbe  
Ø : 8,0 mm

**DC71340-07**

Tube L : 230 mm - 9 "  
Curved / Courbe  
Ø : 6,5 mm



# Suction Hook

## Crochet d'Aspiration

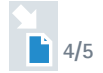

With Finger Plate  
Avec Contrôle Manuel de l'Aspiration



Scale - Échelle : 1/1



DC71800-00

L : 260 mm - 10 1/5 "

# Frazier Suction Tubes

## Canules d'Aspiration Frazier

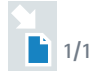

45° - With Suction Control Handle  
 45° - Avec Contrôle Manuel de l'Aspiration



**DC71350-03**

○ Ø : 03 Fr

**DC71350-04**

○ Ø : 04 Fr

**DC71350-05**

○ Ø : 05 Fr

**DC71350-06**

○ Ø : 06 Fr

**DC71350-07**

○ Ø : 07 Fr

**DC71350-08**

○ Ø : 08 Fr

**DC71350-09**

○ Ø : 09 Fr

**DC71350-10**

○ Ø : 10 Fr

**DC71350-11**

○ Ø : 11 Fr

**DC71350-12**

○ Ø : 12 Fr

**DC71350-13**

○ Ø : 13 Fr

**DC71350-14**

○ Ø : 14 Fr

# Baron Suction Tubes

## Canules d'Aspiration Baron

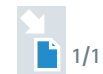

With Suction Control Handle  
Avec Contrôle Manuel de l'Aspiration



**DC71360-03**

○ L : 75 mm - Ø : 03 Fr

**DC71360-05**

○ L : 75 mm - Ø : 05 Fr

**DC71360-07**

○ L : 75 mm - Ø : 07 Fr

**DC71361-03**

○ L : 100 mm - Ø : 03 Fr

**DC71361-05**

○ L : 100 mm - Ø : 05 Fr

**DC71361-07**

○ L : 100 mm - Ø : 07 Fr

# Schuhknecht Micro Suction Tubes

## Micro Canules d'Aspiration Schuhknecht

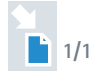

With Suction Control Handle  
Contrôle Manuel de l'Aspiration



**DC71370-20**

L : 75 mm - Ø : 03 Fr

**DC71370-40**

L : 75 mm - Ø : 02 Fr

# Aortic Purge Needle

## Purge Aortique

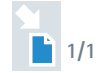

**DC71500-00**  
L : 35 mm - 1 <sup>2</sup>/<sub>5</sub> "

# Male and Female Luer Coupling

## Embout Mâle et Femelle Luer



**DC71380-50**  
L : 50 mm - 2 "

# Murphy Tubing Clamp

## Presse Tube Murphy

Catalogue Landanger  
Chap. IV

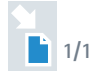

**B95150**  
140 mm - 5 1/2 "

**B95200**  
180 mm - 7 "

**B95205**  
190 mm - 7 1/2 "

**B95210**  
200 mm - 8 "

**Strong Forte**

**With Safety Guard  
Avec Sécurité**

**B952014**  
L : 150 mm - 5 4/5 "

**B952018**  
180 mm - 7 "

**B952020**  
200 mm - 8 "

# Folding Instruments Holder

## Porte Instruments

Catalogue Landanger  
Chap. XV

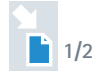

Lortat Jacob

Double folding frame - 9 supports  
Pliable - 9 supports



V78130

Base : 205 mm x 255 mm - 8 " x 10 "  
Height / Hauteur : 300 mm - 12 "







#### Important notice

This catalogue remains property of **Delacroix-Chevalier**. We can at any time recall the catalogue, in case that it has been not used according to our interests, i.e. sale or purchase of our products. We preserve the right for further steps in that case. Reproduction or copying of this catalogue in whole or in parts is forbidden without our written permission. Patterns are subject to change.

#### Indications importantes

Ce catalogue reste la propriété de **Delacroix-Chevalier**. Nous pouvons demander le retour du catalogue dans le cas où celui-ci n'est pas utilisé conformément à nos intérêts, pour la vente ou l'achat de nos produits. Dans ce cas nous nous réservons le droit de mener des actions juridiques. La reproduction ou la copie totale ou partielle de ce catalogue est interdite sans notre accord écrit. Sous réserve des modifications techniques.

#### Version 2011-00

Concept and design - *Conception et design* : **Delacroix-Chevalier** - Photos and pictures are not contractual - *Photos et illustrations non contractuelles*







**Corporate Office - Siège**

13, Avenue de la République - 75011 Paris - France

**Manufacturing and Logistic Offices - Service Clients et Production**

ZI la Vendue - B.P. 2152 - 52906 Chaumont Cedex 9 - France

Phone : +33 (0) 3 25 02 10 35 - Fax : +33 (0) 3 25 02 10 20 - Email : [export@delacroix-chevalier.com](mailto:export@delacroix-chevalier.com)  
[www.delacroix-chevalier.com](http://www.delacroix-chevalier.com)



# LANDANGER

---

1947



CHIRURGIE - SURGERY - CIRUGÍA

---

**Pour tout renseignement, devis et commandes :**

**For all information, estimates and orders :**

**Para más información, cotizaciones y pedidos :**



Tél. (France) : 0325021010

Tel. (Export) : +33 325021010

Du lundi au vendredi - Monday to friday - Del lunes al viernes

De 8 heures à 18 heures - From 8:00 am to 6:00 pm (no stop) - Desde las 8 a las 18



Fax (France) : 0325021020

Fax (Export) : +33 325021020



France : [contact@landanger.com](mailto:contact@landanger.com)

Export : [export@landanger.com](mailto:export@landanger.com)



LANDANGER

ZI la Vendue

BP 2152 - 52906 Chaumont cedex 9

FRANCE

[www.landanger.com](http://www.landanger.com)

Contact :

---

---

---

---

---

**N° 1  
FRANCE**

**15000  
Références**

**100 %  
Qualité**

L A N D A N G E R

---

1947

*Notre passion,  
notre histoire,  
créent  
la différence.*

*Our passion, our history, make the difference - Nuestra pasión, nuestra historia, creen la diferencia*





Bistouris fixes - One-piece scalpels - Bisturís fijos

FARABEUF NELATON SIMS TENOTOME

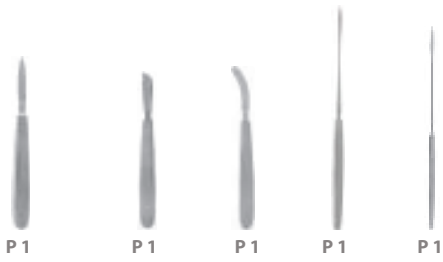

Manches réutilisables, lames U.U. - Reusable handles, single use blades - Mangos reutilizables, hoja único uso

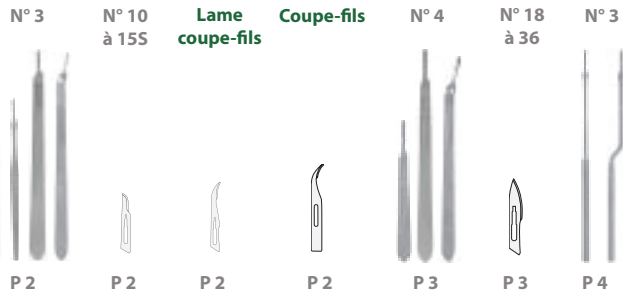

Bistouris à usage unique stériles - Single use sterile scalpels - Bisturís único uso

STANDARD PRIMA **Coupe-fils**



Dermatome à main - Hand dermatome - Dermátomo de mano

SCHINK

LAGROT

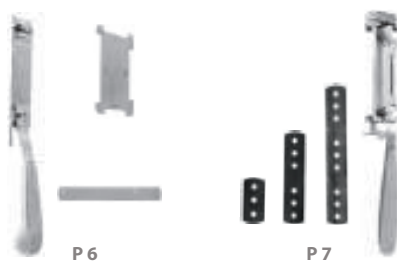

Amplificateur greffe de peau - Graft skin amplifier - Amplificador incorpora de piel



P 8

**I - Incision**  
*I - Incision*  
*I - Incision*

# LANDANGER

Bistouris fixes - One-piece scalpels - Bisturís fijos

I - Incision  
I - Incision  
I - Incision

FARABEUF

NELATON

SIMS

TENOTOME



Lame 45 mm  
Blade 1 3/4 "  
Hoja 45 mm

Lame 35 mm  
Blade 1 1/2 "  
Hoja 35 mm

Lame 45 mm  
Blade 1 3/4 "  
Hoja 45 mm

Lame 20 mm  
Blade 3/4 "  
Hoja 20 mm

Lame 20 mm  
Blade 3/4 "  
Hoja 20 mm



**B05033**  
15,5 cm - 6 "



**B05060**  
15,5 cm - 6 "



**B05070**  
16 cm - 6 1/4 "



**B05090**  
22 cm - 8 3/4 "



**B05103**  
16 cm - 6 1/4 "  
**B05104**  
20 cm - 8 "

# LANDANGER

Manches réutilisables, lames U.U. - Reusable handles, single use blades - Mangos reutilizables, hoja único uso



N° 3	N° 7 (ex 5)	N° 3L	N° 3L coudé	
<b>B12000</b>	<b>B110050</b>	<b>B11013</b>	<b>B12008</b>	Inox - Stainless steel - Acero inoxidable
<b>B12003</b>	<b>B12005</b>	<b>B12006</b>	-	Alliage - Alloy - Aleación



**B12000**  
12,5 cm - 5 "

**B12005**  
16 cm - 6 1/4 "

**B11013**  
21 cm - 8 1/4 "

**B12008**  
20,5 cm - 8 "



Modèle de lame  
Blade model  
Modelo de hoja

Boite de 100  
Box of 100  
Caja de 100

Lame carbone  
Carbon blade  
Hoja carbono

**10**



**B130100**

**11P**



**B13011P**

**12**



**B130120**

**15S**



**B13015S**

Coupe fils pour manche n°3  
Stitch cutter for handle n°3  
Corta hilos para mango n°3

Boite de 50  
Box of 50  
Caja de 50



**B130700**

Coupe fils standard  
Standard stitch cutter  
Corta hilos estándar

Boite de 100  
Box of 100  
Caja de 100

**B130710**



# LANDANGER

Manches réutilisables, lames U.U. - Reusable handles, single use blades - Mangos reutilizables, hoja único uso



I - Incision  
I - Incision  
I - Incision

N° 4

**B12001**

**B12004**

N° 4L

**B11014**

**B12007**

N° 4L coudé

**B12009**

-

Inox - Stainless steel - Acero inoxidable

Alliage - Alloy - Aleación



Boite de 100  
Box of 100  
Caja de 100

Modèle de lame  
Blade model  
Modelo de hoja

Lame carbone  
Carbon blade  
Hoja carbono

<b>18</b>		<b>B130180</b>
<b>19</b>		<b>B130190</b>
<b>20</b>		<b>B130200</b>
<b>21</b>		<b>B130210</b>
<b>22</b>		<b>B130220</b>
<b>23</b>		<b>B130230</b>
<b>24</b>		<b>B130240</b>
<b>36</b>		<b>B130360</b>

**B12001**

13,5 cm - 5 1/4 "

**B11014**

21 cm - 8 1/4 "

**B12009**

21,5 cm - 8 1/2 "

# LANDANGER

Manches de bistouris - Scalpel handles - Mangos de bisturís



**ROND DROIT**  
ROUND STRAIGHT  
REDONDO RECTO

N° 3



**B123000**  
21 cm - 8 1/4 "

**ROND DROIT BAÏONNETTE**  
ROUND STRAIGHT BAYONET  
REDONDO RECTO BAYONETA

N° 3



**B123001**  
21 cm - 8 1/4 "

Pour lames de bistouris 10, 11P, 12, 15S  
For 10, 11P, 12, 15S scalpel blades  
Para hojas de bisturís 10, 11P, 12, 15S

# LANDANGER

## Bistouris à usage unique stériles - Single use sterile scalpels - Bisturís único uso estéril

I - Incision  
I - Incision  
I - Incision

Modèle de lame  
Blade model  
Modelo de hoja

Bistouris standard boîte de 10  
Standard scalpels box of 10  
Bisturís estándar caja de 10

Bistouris PRIMA boîte de 10  
PRIMA scalpels box of 10  
Bisturís PRIMA caja de 10

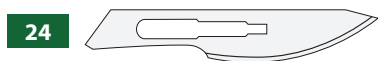
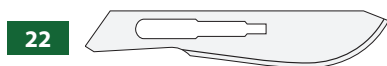
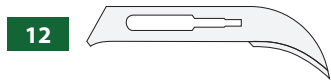

N° 21

B132100

B13211P

B132120

B13215S

B132180

B132190

B132200

B132210

B132220

B132230

B132240



N° 23

B134100

B13411P

B134120

B13415S

B134180

B134190

B134200

B134210

B134220

B134230

B134240

Bistouri coupe fils  
Stitch cutter scalpel  
Bistouri corta hilos

Boîte de 10  
Box of 10  
Caja de 10



B132700

# LANDANGER

Dermatome à main - Hand dermatome - Dermátomo de mano



## SCHINK



### B20030

Plaque  
Plate  
Placa

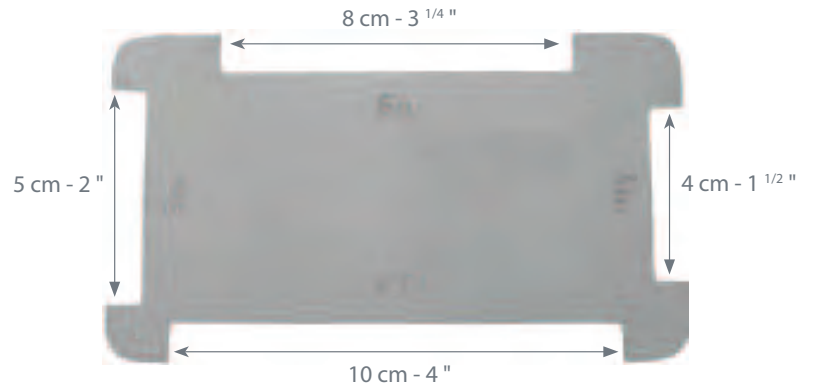

### B20010

30 cm - 11 3/4 "

Livré avec 2 plaques, 1 lame  
Supplied with 2 plates, 1 blade  
Entregado con 2 placas, 1 hoja

### B20040

Lame de rechange  
Spare blade  
Hoja de cambio



10 cm - 4 "





# LANDANGER

Dermatome à main - Hand dermatome - Dermátomo de mano

I - Incision  
I - Incision  
I - Incision

## LAGROT



Livré avec 1 boîte de 6 lames  
Supplied with 1 box of 6 blades  
Entregado con 1 caja de 6 hojas

**B20045** 40 mm - 1 1/2 "  
**B20050** 90 mm - 3 1/2 "  
**B20060** 140 mm - 5 1/2 "

Boîte de 6 lames  
Box of 6 blades  
Caja de 6 hojas



Boîte de 6 lames  
Box of 6 blades  
Caja de 6 hojas

Boîte de 6 lames  
Box of 6 blades  
Caja de 6 hojas



**B20015**  
40 mm - 1 1/2 "



**B20020**  
90 mm - 3 1/2 "



**B20025**  
140 mm - 5 1/2 "



**B20050**  
30 cm - 11 3/4 "

I-7

# LANDANGER

Amplificateur greffe de peau - Graft skin amplifier - Amplificador incorpora de piel

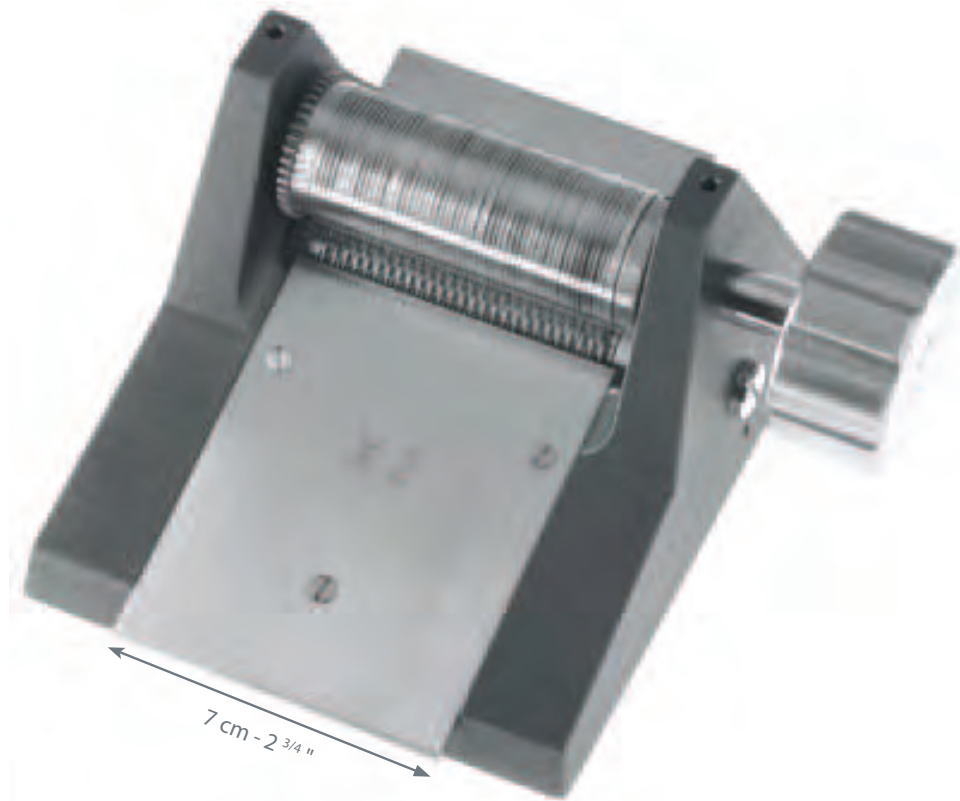

Expansion maximum - Maximum expansion - Expansión máxima

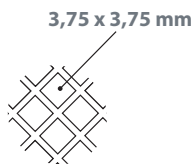

**B201020**  
x 2

Chirurgie plastique  
Plastic surgery  
Cirugía plástica

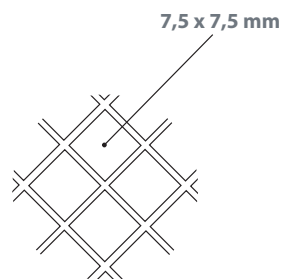

**B201040**  
x 4

Brûlés, ulcères, escarres  
Burnt, ulcers, bedsores  
Quemados, úlceras, escaras

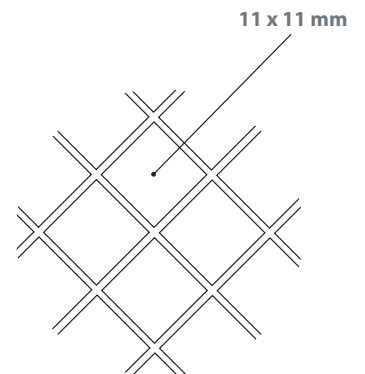

**B201060**  
x 6

Grands brûlés  
Deep burnt  
Grandes quemados

Pinces à dissection - Dissection forceps - Pinzas para disección

**Standard** - Standard - Estandar

**Moyenne** - Middle - Medio

**Fine** - Fine - Fina

**VINCENT**



Pinces à dissection spéciales - Special dissection forceps - Pinzas para disección especiales

**LANE**

**STRASBOURG**

**DURAND**

**MAYO**

**GREGOIRE**

**FAURE**

**DESGOUTTES**

**BROWN RESANO**

**QUENU**



**FARKAS**

**DUVAL**

**SINGLEY  
TUTTLE**

**LE PETIT**

**A épiler**  
For epilation  
Para depilation

**GILLIES  
(WAUGH)**

**SEMKEN**

**A échardes**  
Splinter forceps  
Pinzas para astillas

**MICRO**

**DUMONT**

**FEILCHENFELD  
HUNTER  
WALTER-CARMALT**

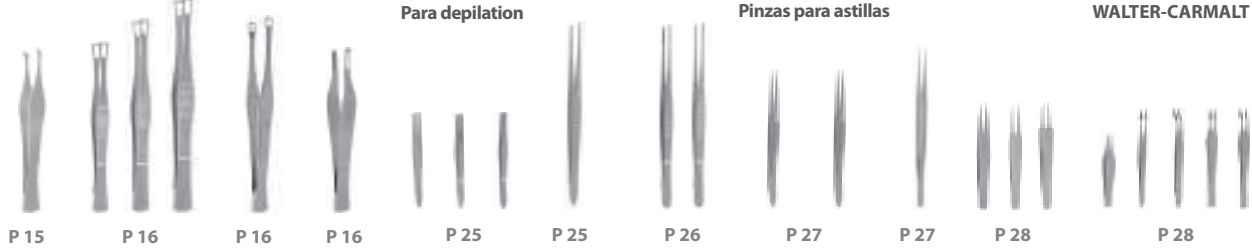

Pinces à dissection délicates - Delicate dissection forceps - Pinzas para disección delicadas

**BARRAYA**

**ADLERKREUTZ**

**ADSON**

**MICRO ADSON**

**ADSON BROWN**

**MC INDOE**

**CUSHING**

**POTTS**

**SMITH**

**TAYLOR**

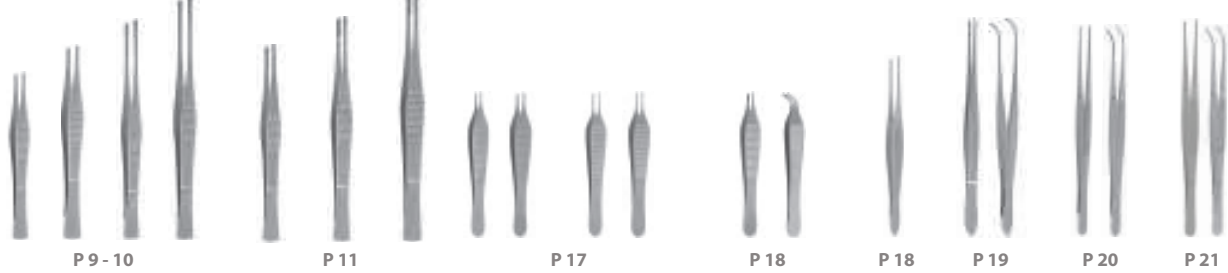

Pinces à dissection délicates - Delicate dissection forceps - Pinzas para disección delicadas

**MERIAM**

**GERALD**

**Précelles**

**PERRY**

**Fine  
Fine  
Fina**



Pinces O.R.L. & Ophtamologie - ENT & Ophtalmologic forceps - Pinzas O.R.L. & Oftalmología

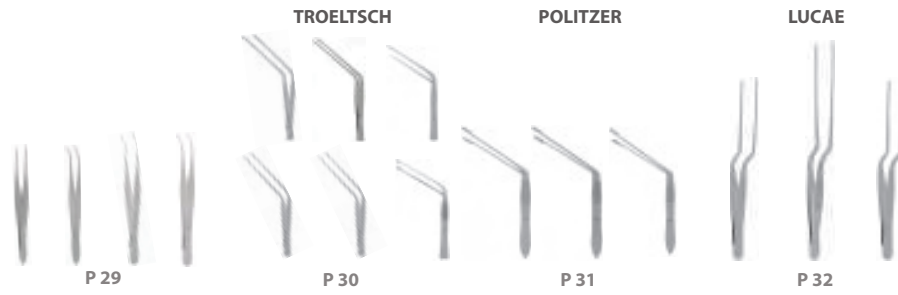

Pinces à dissection vasculaires - Vascular dissection forceps - Pinzas para disección vasculares

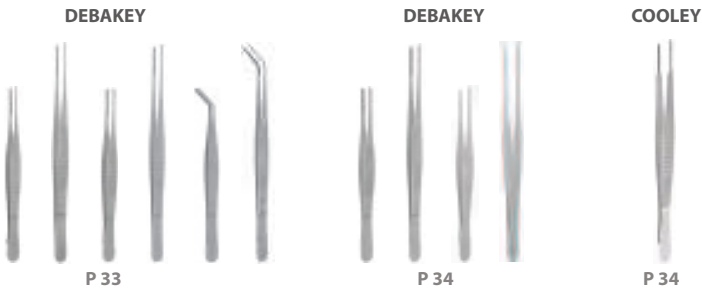

Pinces à dissection mors tungstène - Dissection forceps with tungsten jaws - Pinzas para disección boca de tungsteno

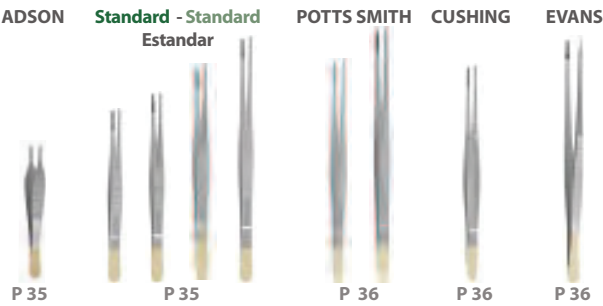

Pinces à dissection Prestige - Prestige dissection forceps - Pinzas para disección Prestige

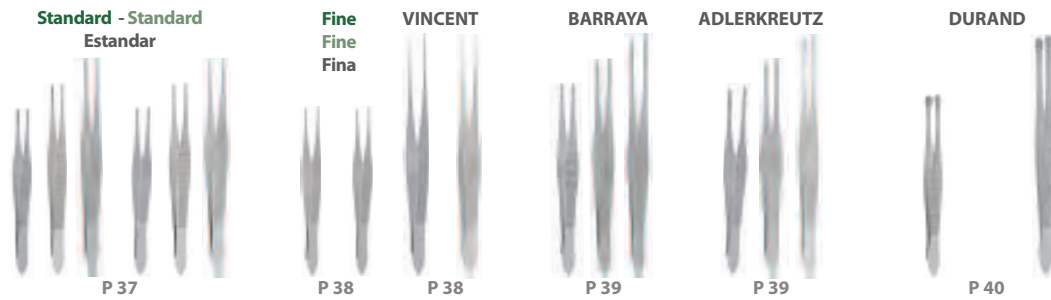

Microchirurgie pincettes - Microsurgery fine forceps - Microcirugía pinzas pequeñas



# LANDANGER

## Pinces à dissection standards - Standard dissection forceps - Pinzas para disección estándares

STANDARD  
STANDARD  
ESTÁNDAR



Sans griffes  
Without teeth  
Sin dientes

10 cm - 4 "	<b>B40005</b>
12 cm - 4 3/4 "	<b>B40010</b>
14 cm - 5 1/2 "	<b>B40015</b>
16 cm - 6 1/4 "	<b>B40020</b>
18 cm - 7 "	<b>B40025</b>
20 cm - 8 "	<b>B40030</b>
25 cm - 10 "	<b>B40035</b>
30 cm - 11 3/4 "	<b>B40040</b>

1 x 2 griffes  
1 x 2 teeth  
1 x 2 dientes

10 cm - 4 "	<b>B40045</b>
12 cm - 4 3/4 "	<b>B40050</b>
14 cm - 5 1/2 "	<b>B40055</b>
16 cm - 6 1/4 "	<b>B40060</b>
18 cm - 7 "	<b>B40065</b>
20 cm - 8 "	<b>B40070</b>
25 cm - 10 "	<b>B40075</b>
30 cm - 11 3/4 "	<b>B40080</b>



**B40010**  
12 cm - 4 3/4 "

**B40015**  
14 cm - 5 1/2 "

**B40020**  
16 cm - 6 1/4 "

**B40050**  
12 cm - 4 3/4 "

**B40055**  
14 cm - 5 1/2 "

**B40060**  
16 cm - 6 1/4 "

II - Dissection  
II - Dissecting  
II - Disección

# LANDANGER

Pinces à dissection standards - Standard dissection forceps - Pinzas para disección estándares



STANDARD  
STANDARD  
ESTÁNDAR

2 x 3 griffes    3 x 4 griffes  
2 x 3 teeth    3 x 4 teeth  
2 x 3 dientes    3 x 4 dientes

14 cm - 5 1/2 "	<b>B40090</b>	-
16 cm - 6 1/4 "	<b>B40095</b>	<b>B400951</b>
18 cm - 7 "	<b>B40100</b>	-
20 cm - 8 "	<b>B40105</b>	-
25 cm - 10 "	<b>B40092</b>	-



**B40090**  
14 cm - 5 1/2 "



**B40095**  
16 cm - 6 1/4 "



**B40100**  
18 cm - 7 "

# LANDANGER

## Pinces à dissection moyennes - Medium dissection forceps - Pinzas para disección medias finas

MOYEN  
MEDIUM  
MEDIO



Sans griffes  
Without teeth  
Sin dientes

16 cm - 6 1/4 "	<b>B40021</b>
18 cm - 7 "	<b>B40026</b>
20 cm - 8 "	<b>B40031</b>

1 x 2 griffes  
1 x 2 teeth  
1 x 2 dientes

16 cm - 6 1/4 "	<b>B40061</b>
18 cm - 7 "	<b>B40066</b>
20 cm - 8 "	<b>B40071</b>

II - Dissection  
II - Dissecting  
II - Disección



**B40021**  
16 cm - 6 1/4 "



**B40061**  
16 cm - 6 1/4 "

# LANDANGER

## Pinces à dissection fines - Fine dissection forceps - Pinzas para disección finas



II - Dissection  
II - Dissecting  
II - Disección

FINE, DROITE  
FINE, STRAIGHT  
FINA, RECTA

Sans griffes  
Without teeth  
Sin dientes

1 x 2 griffes  
1 x 2 teeth  
1 x 2 dientes

10 cm - 4 "	<b>B40120</b>
12 cm - 4 3/4 "	<b>B40125</b>
14 cm - 5 1/2 "	<b>B40130</b>
16 cm - 6 1/4 "	<b>B40135</b>
18 cm - 7 "	<b>B40140</b>
20 cm - 8 "	<b>B401430</b>
25 cm - 10 "	<b>B401432</b>
30 cm - 11 3/4 "	<b>B401434</b>

10 cm - 4 "	<b>B40145</b>
12 cm - 4 3/4 "	<b>B40150</b>
14 cm - 5 1/2 "	<b>B40155</b>
16 cm - 6 1/4 "	<b>B40160</b>
18 cm - 7 "	<b>B40165</b>
20 cm - 8 "	<b>B401680</b>
25 cm - 10 "	<b>B401682</b>
30 cm - 11 3/4 "	<b>B401684</b>

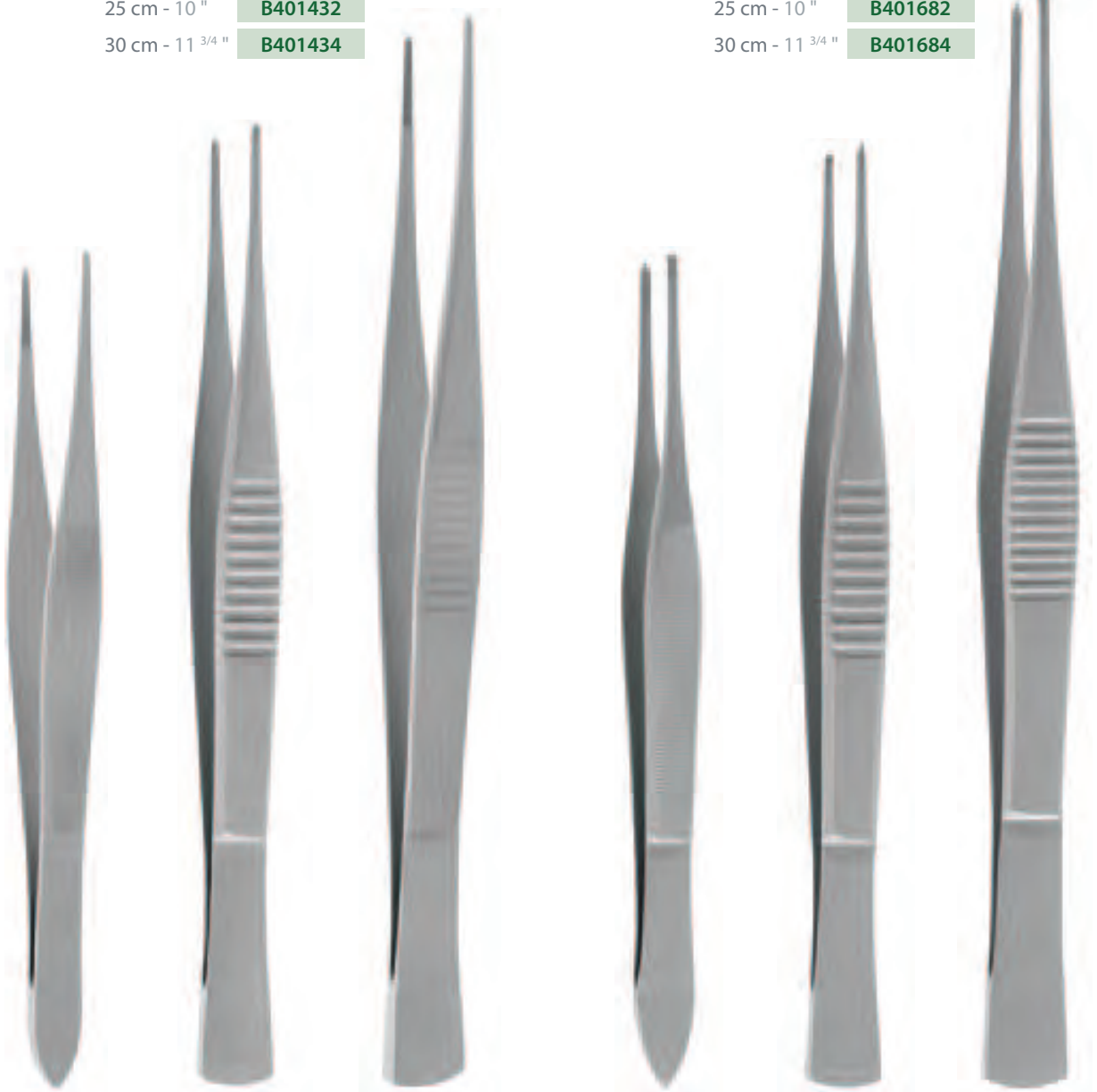

**B40130**  
14 cm - 5 1/2 "

**B40135**  
16 cm - 6 1/4 "

**B40140**  
18 cm - 7 "

**B40155**  
14 cm - 5 1/2 "

**B40160**  
16 cm - 6 1/4 "

**B40165**  
18 cm - 7 "



# LANDANGER

## Pinces à dissection fines - Fine dissection forceps - Pinzas para disección finas

Sans griffes  
Without teeth  
Sin dientes

FINE, COURBE  
FINE, CURVED  
FINA, CURVA

1 x 2 griffes  
1 x 2 teeth  
1 x 2 dientes



10 cm - 4 "	<b>B401220</b>
12 cm - 4 <sup>3</sup> / <sub>4</sub> "	<b>B401270</b>
14 cm - 5 <sup>1</sup> / <sub>2</sub> "	<b>B40132</b>
16 cm - 6 <sup>1</sup> / <sub>4</sub> "	<b>B401370</b>
18 cm - 7 "	<b>B401420</b>
20 cm - 8 "	<b>B401431</b>
25 cm - 10 "	<b>B401433</b>
30 cm - 11 <sup>3</sup> / <sub>4</sub> "	<b>B401435</b>

10 cm - 4 "	<b>B401470</b>
12 cm - 4 <sup>3</sup> / <sub>4</sub> "	<b>B401520</b>
14 cm - 5 <sup>1</sup> / <sub>2</sub> "	<b>B40157</b>
16 cm - 6 <sup>1</sup> / <sub>4</sub> "	<b>B401620</b>
18 cm - 7 "	<b>B401670</b>
20 cm - 8 "	<b>B401681</b>
25 cm - 10 "	<b>B401683</b>
30 cm - 11 <sup>3</sup> / <sub>4</sub> "	<b>B401685</b>



**B40132**  
14 cm - 5 <sup>1</sup>/<sub>2</sub> "

**B401370**  
16 cm - 6 <sup>1</sup>/<sub>4</sub> "

**B401420**  
18 cm - 7 "

**B40157**  
14 cm - 5 <sup>1</sup>/<sub>2</sub> "

**B401620**  
16 cm - 6 <sup>1</sup>/<sub>4</sub> "

**B401670**  
18 cm - 7 "

II - Dissection  
II - Dissecting  
II - Disección

# LANDANGER

Pinces à dissection très fines - Very fine dissection forceps - Pinzas para disección muy finas



## VINCENT

II - Dissection  
II - Dissecting  
II - Disección



**B40170**  
20 cm - 8 "

Sans griffes  
Without teeth  
Sin dientes

15 cm - 6 "	<b>B401698</b>
18 cm - 7 "	<b>B401699</b>
20 cm - 8 "	<b>B40170</b>
25 cm - 10 "	<b>B401710</b>
30 cm - 11 <sup>3</sup> / <sub>4</sub> "	<b>B401711</b>



**B40175**  
20 cm - 8 "

1 x 2 griffes  
1 x 2 teeth  
1 x 2 dientes

15 cm - 6 "	<b>B401748</b>
18 cm - 7 "	<b>B401749</b>
20 cm - 8 "	<b>B40175</b>
25 cm - 10 "	<b>B401760</b>
30 cm - 11 <sup>3</sup> / <sub>4</sub> "	<b>B401761</b>

# LANDANGER

Pinces à dissection spéciales - Special dissection forceps - Pinzas para disección especiales



## LANE

2 x 3 griffes  
2 x 3 teeth  
2 x 3 dientes



**B401810**  
15 cm - 6"



**B401811**  
20 cm - 8"

II - Dissection  
II - Dissecting  
II - Disección

# LANDANGER

Pinces à dissection spéciales - Special dissection forceps - Pinzas para disección especiales



## STRASBOURG

14 cm - 5 1/2 "	<b>B40200</b>
16 cm - 6 1/4 "	<b>B40205</b>
18 cm - 7 "	<b>B40210</b>
20 cm - 8 "	<b>B40215</b>
25 cm - 10 "	<b>B402151</b>
30 cm - 11 3/4 "	<b>B402152</b>

1 x 2 griffes, à talon  
1 x 2 teeth, with heel  
1 x 2 dientes, con talon

1 x 2 griffes, à talon  
1 x 2 teeth, with heel  
1 x 2 dientes, con talon



**B40200**  
14 cm - 5 1/2 "



**B40205**  
16 cm - 6 1/4 "



**B40210**  
18 cm - 7 "



**B40215**  
20 cm - 8 "



## BARRAYA

14 cm - 5 1/2 "	<b>B40225</b>
16 cm - 6 1/4 "	<b>B40230</b>
18 cm - 7 "	<b>B40235</b>
20 cm - 8 "	<b>B40240</b>
25 cm - 10 "	<b>B40245</b>
30 cm - 11 3/4 "	<b>B402451</b>

2 x 3 griffes, mors étroits  
 Quadrillés  
 2 x 3 teeth, narrow jaws  
 Squared  
 2 x 3 dientes, boca estrecha  
 Cuadriculada

2 x 3 griffes, mors étroits  
 Quadrillés  
 2 x 3 teeth, narrow jaws  
 Squared  
 2 x 3 dientes, boca estrecha  
 Cuadriculada

II - Dissection  
 II - Dissecting  
 II - Disección



**B40225**  
 14 cm - 5 1/2 "



**B40230**  
 16 cm - 6 1/4 "



**B40235**  
 18 cm - 7 "



**B40240**  
 20 cm - 8 "

# LANDANGER

Pinces à dissection délicates - Delicate dissection forceps - Pinzas para disección delicadas



## BARRAYA

16 cm - 6 1/4 "	<b>B402455</b>
18 cm - 7 "	<b>B40246</b>
20 cm - 8 "	<b>B40248</b>
25 cm - 10 "	<b>B40249</b>
30 cm - 11 3/4 "	<b>B402491</b>

4 x 5 griffes, mors larges  
Quadrillés  
4 x 5 teeth, wide jaws  
Squared  
4 x 5 dientes, boca ancha  
Cuadriculada

4 x 5 griffes, mors larges  
Quadrillés  
4 x 5 teeth, wide jaws  
Squared  
4 x 5 dientes, boca ancha  
Cuadriculada



**B40246**  
18 cm - 7 "



**B40248**  
20 cm - 8 "



**B40249**  
25 cm - 10 "



## ADLERKREUTZ

14 cm - 5 1/2 "	<b>B40374</b>
16 cm - 6 1/4 "	<b>B40375</b>
18 cm - 7 "	<b>B40380</b>
20 cm - 8 "	<b>B40385</b>
25 cm - 10 "	<b>B40390</b>
30 cm - 11 3/4 "	<b>B403950</b>

3 x 4 griffes, à talon  
3 x 4 teeth, with heel  
3 x 4 dientes, con talon

3 x 4 griffes, à talon  
3 x 4 teeth, with heel  
3 x 4 dientes, con talon



**B40375**  
16 cm - 6 1/4 "



**B40380**  
18 cm - 7 "



**B40385**  
20 cm - 8 "

# LANDANGER

Pinces à dissection spéciales - Special dissection forceps - Pinzas para disección especiales



## DURAND

- 15 cm - 6 " **B40250**
- 20 cm - 8 " **B40255**
- 25 cm - 10 " **B40260**
- 30 cm - 11 3/4 " **B40265**

## MAYO



**B402660**  
23 cm - 9 "

## GREGOIRE

- 18 cm - 7 " **B40270**
- 20 cm - 8 " **B40275**
- 30 cm - 11 3/4 " **B402770**



**B40270**  
18 cm - 7 "



**B40275**  
20 cm - 8 "

Patte de velours  
Russian Model  
Modelo Ruso



**B40250**  
15 cm - 6 "



**B40255**  
20 cm - 8 "

II - Dissection  
II - Dissecting  
II - Disección





## J.L. FAURE

- 18 cm - 7" **B40415**
- 20 cm - 8" **B40420**
- 25 cm - 10" **B40425**
- 30 cm - 11 <sup>3</sup>/<sub>4</sub>" **B404251**

3 x 4 griffes  
3 x 4 teeth  
3 x 4 dientes

3 x 4 griffes  
3 x 4 teeth  
3 x 4 dientes



**B40415**  
18 cm - 7"



**B40420**  
20 cm - 8"



**B40425**  
25 cm - 10"

II - Dissection  
II - Dissecting  
II - Disección

# LANDANGER

Pinces à dissection spéciales - Special dissection forceps - Pinzas para disección especiales



## DESGOUTTES

17 cm - 6 <sup>3</sup> / <sub>4</sub> "	<b>B40280</b>
20 cm - 8 "	<b>B40285</b>
22 cm - 8 <sup>5</sup> / <sub>8</sub> "	<b>B40290</b>
25 cm - 10 "	<b>B40295</b>
30 cm - 11 <sup>3</sup> / <sub>4</sub> "	<b>B40300</b>

## BROWN RESANO

20 cm - 8 "	<b>B40305</b>
25 cm - 10 "	<b>B40310</b>
30 cm - 11 <sup>3</sup> / <sub>4</sub> "	<b>B40315</b>

4 x 5 griffes  
4 x 5 teeth  
4 x 5 dientes



**B40280**  
17 cm - 6 <sup>3</sup>/<sub>4</sub> "



**B40285**  
20 cm - 8 "



**B40305**  
20 cm - 8 "

# LANDANGER

Pinces à dissection spéciales - Special dissection forceps - Pinzas para disección especiales

## QUENU

12 cm - 4 <sup>3</sup> / <sub>4</sub> "	<b>B40325</b>
15 cm - 6 "	<b>B40330</b>
18 cm - 7 "	<b>B40335</b>
20 cm - 8 "	<b>B40340</b>
25 cm - 10 "	<b>B40345</b>
30 cm - 11 <sup>3</sup> / <sub>4</sub> "	<b>B40350</b>

## FARKAS



12 cm - 4 <sup>3</sup> / <sub>4</sub> "	<b>B404349</b>
15 cm - 5 <sup>3</sup> / <sub>4</sub> "	<b>B40435</b>
18 cm - 7 "	<b>B404360</b>



**B40330**  
15 cm - 6 "



**B40335**  
18 cm - 7 "



**B40340**  
20 cm - 8 "



**B40435**  
15 cm - 6 "

II - Dissection  
II - Dissecting  
II - Disección

# LANDANGER

Pinces à dissection spéciales - Special dissection forceps - Pinzas para disección especiales



## DUVAL

- 15 cm - 6 " **B40355**
- 18 cm - 7 " **B40360**
- 20 cm - 8 " **B40365**

## SINGLEY TUTTLE

- 18 cm - 7 " **B403670**
- 23 cm - 9 " **B403680**
- 30 cm - 11 <sup>3</sup>/<sub>4</sub> " **B403690**

## LE PETIT

- 15 cm - 6 " **B404370**
- 18 cm - 7 " **B404371**

Mors 10 mm  
Jaw 10 mm  
Boca 10 mm

1 x 2 griffes  
1 x 2 teeth  
1 x 2 dientes

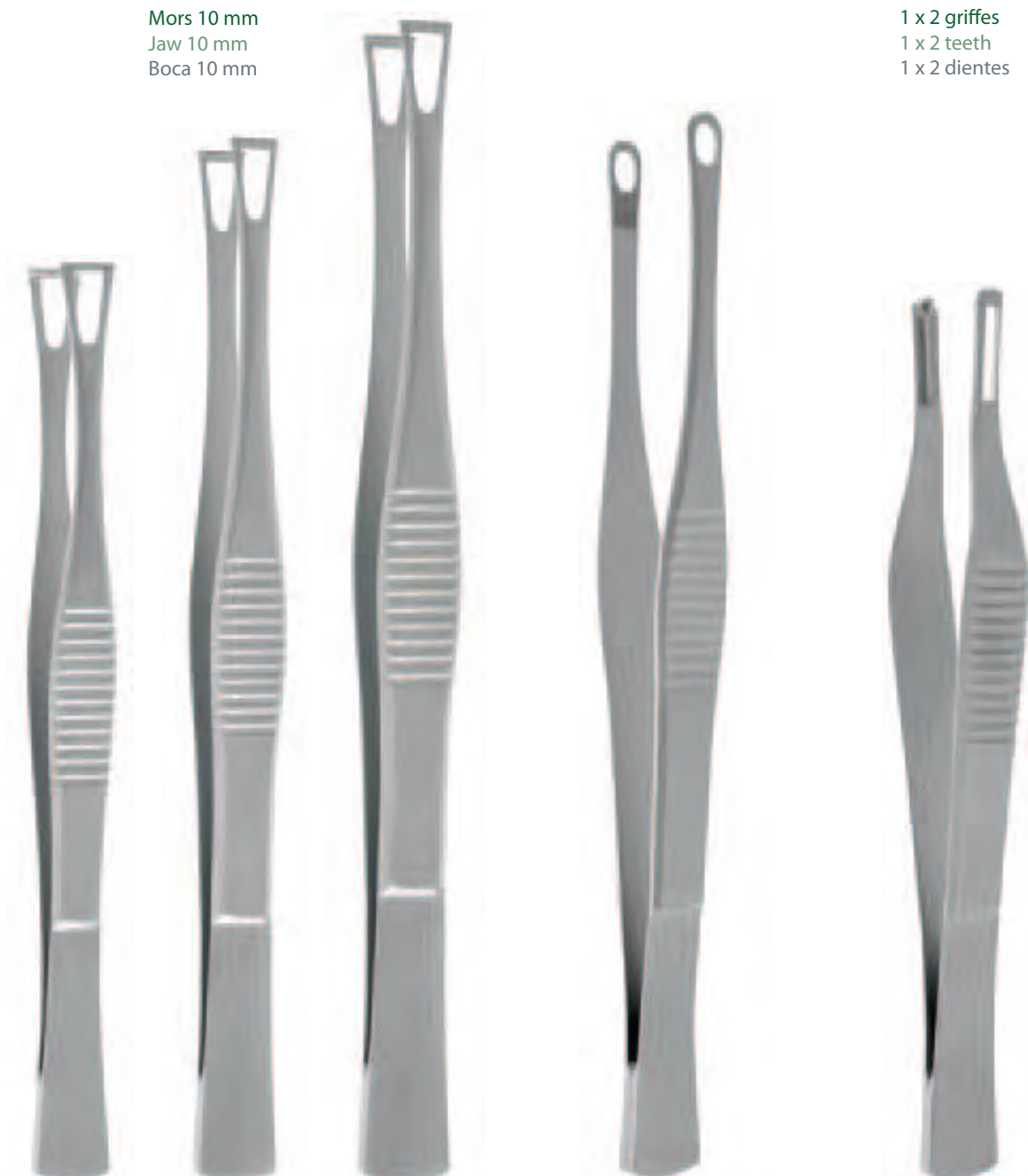

**B40355**  
15 cm - 6 "

**B40360**  
18 cm - 7 "

**B40365**  
20 cm - 8 "

**B403670**  
18 cm - 7 "

**B404370**  
15 cm - 6 "

# LANDANGER

Pinces à dissection délicates - Delicate dissection forceps - Pinzas para disección delicadas



## ADSON

## MICRO-ADSON

Sans griffes    A griffes  
Without teeth    With teeth  
Sin dientes    Con dientes

Sans griffes    A griffes  
Without teeth    With teeth  
Sin dientes    Con dientes

12 cm - 4 3/4 "	<b>B40440</b>	<b>B40445</b>
15 cm - 6 "	<b>B404450</b>	<b>B404451</b>
18 cm - 7 "	<b>B404453</b>	<b>B404454</b>

12 cm - 4 3/4 "	<b>B40447</b>	<b>B40446</b>
15 cm - 6 "	<b>B404470</b>	<b>B404471</b>



**B40440**  
12 cm - 4 3/4 "



**B40445**  
12 cm - 4 3/4 "



**B40447**  
12 cm - 4 3/4 "



**B40446**  
12 cm - 4 3/4 "

II - Dissection  
II - Dissecting  
II - Disección

# LANDANGER

Pinces à dissection délicates - Delicate dissection forceps - Pinzas para disección delicadas



II - Dissection  
II - Dissecting  
II - Disección

## ADSON BROWN

Droite  
Straight  
Recta

Coudée  
Bent  
Angulada

12 cm - 4 <sup>3</sup>/<sub>4</sub> "

**B40448**

**B404490**

## MC INDOE



**B40448**

12 cm - 4 <sup>3</sup>/<sub>4</sub> "



**B404490**

12 cm - 4 <sup>3</sup>/<sub>4</sub> "



**B404010**

15 cm - 6 "

# LANDANGER

Pinces à dissection délicates - Delicate dissection forceps - Pinzas para disección delicadas



## CUSHING

Sans griffes 1 x 2 griffes  
Without teeth 1 x 2 teeth  
Sin dientes 1 x 2 dientes

18 cm - 7 "

**B40400**

**B404020**

Sans griffes 1 x 2 griffes  
Without teeth 1 x 2 teeth  
Sin dientes 1 x 2 dientes

18 cm - 7 "

**B404021**

**B404022**



Droite  
Straight  
Recta

**B40400**

18 cm - 7 "



Courbe  
Curved  
Curva

**B404021**

18 cm - 7 "

II - Dissection  
II - Dissecting  
II - Disección

# LANDANGER

## Pinces à dissection délicates - Delicate dissection forceps - Pinzas para disección delicadas



II - Dissection  
II - Dissecting  
II - Disección

### POTTS SMITH

Sans griffes 1 x 2 griffes  
Without teeth 1 x 2 teeth  
Sin dientes 1 x 2 dientes

Sans griffes 1 x 2 griffes  
Without teeth 1 x 2 teeth  
Sin dientes 1 x 2 dientes

18 cm - 7 "	<b>B407810</b>	<b>B407840</b>
21 cm - 8 1/4 "	<b>B407820</b>	<b>B407850</b>
25 cm - 10 "	<b>B407830</b>	<b>B407860</b>

18 cm - 7 "	<b>B407811</b>	<b>B407841</b>
21 cm - 8 1/4 "	<b>B407821</b>	<b>B407851</b>
25 cm - 10 "	<b>B407831</b>	<b>B407861</b>



Droite  
Straight  
Recta

**B407840**  
18 cm - 7 "



Courbe  
Curved  
Curva

**B407811**  
18 cm - 7 "



TAYLOR

1 x 2 griffes  
1 x 2 teeth  
1 x 2 dientes

1 x 2 griffes  
1 x 2 teeth  
1 x 2 dientes

II - Dissection  
II - Dissecting  
II - Disección



Droite  
Straight  
Recta

**B404100**  
17,5 cm - 7 "



Courbe  
Curved  
Curva

**B404101**  
17,5 cm - 7 "

# LANDANGER

## Pinces à dissection délicates - Delicate dissection forceps - Pinzas para disección delicadas



### MERIAM

II - Dissection  
II - Dissecting  
II - Disección

Sans griffes 1 x 2 griffes  
Without teeth 1 x 2 teeth  
Sin dientes 1 x 2 dientes

16 cm - 6 1/4 "

**B403954**

**B403955**

Sans griffes 1 x 2 griffes  
Without teeth 1 x 2 teeth  
Sin dientes 1 x 2 dientes

16 cm - 6 1/4 "

**B403952**

**B403953**



Droite  
Straight  
Recta

**B403955**  
16 cm - 6 1/4 "



Courbe  
Curved  
Curva

**B403953**  
16 cm - 6 1/4 "

# LANDANGER

Pinces à dissection délicates - Delicate dissection forceps - Pinzas para disección delicadas



## GERALD

Sans griffes 1 x 2 griffes  
Without teeth 1 x 2 teeth  
Sin dientes 1 x 2 dientes

18 cm - 7 "

**B40406**

**B40404**

Sans griffes 1 x 2 griffes  
Without teeth 1 x 2 teeth  
Sin dientes 1 x 2 dientes

18 cm - 7 "

**B404061**

**B404041**



Droite  
Straight  
Recta

**B40404**

18 cm - 7 "



Courbe  
Curved  
Curva

**B404041**

18 cm - 7 "

II - Dissection  
II - Dissecting  
II - Disección

# LANDANGER

## Pinces à dissection délicates - Delicate dissection forceps - Pinzas para disección delicadas



II - Dissection  
II - Dissecting  
II - Disección

**PRÉCELLES COUDÉES**  
ANGLED FORCEPS  
PINZAS ANGULADAS

**PERRY**

Sans griffes	1 x 2 griffes
Without teeth	1 x 2 teeth
Sin dientes	1 x 2 dientes

**PINCES TRÈS FINES**  
VERY FINE FORCEPS  
PINZAS MUY FINAS

**PINCE À ÉCHARDES**  
SPLINTERS FORCEPS  
PINZA PARA ASTILLAS

Sans griffes	1 x 2 griffes
Without teeth	1 x 2 teeth
Sin dientes	1 x 2 dientes



**B40800**  
9,5 cm - 3 3/4 "



**B40810**  
16 cm - 6 1/4 "



**B40820**  
16 cm - 6 1/4 "



**B408250**  
12 cm - 4 3/4 "



**B40840**  
11 cm - 4 1/4 "



**B40830**  
11 cm - 4 1/4 "

# LANDANGER

Pinces à dissection spéciales - Special dissection forceps - Pinzas para disección especiales



GILLIES

GILLIES  
(WAUGH)

B408601	15 cm - 6 "	B408602
-	20 cm - 7 3/4 "	B408603

À ÉPILER  
FOR EPILATION  
PARA DEPILACIÓN

1 x 2 griffes  
1 x 2 teeth  
1 x 2 dientes



**B408010**  
8 cm - 3 "



**B408020**  
8 cm - 3 "



**B408030**  
8 cm - 3 "



**B408601**  
15 cm - 6 "



**B408602**  
15 cm - 6 "

II - Dissection  
II - Dissecting  
II - Disección

# LANDANGER

Pinces à dissection spéciales - Special dissection forceps - Pinzas para disección especiales



## SEMKEN

II - Dissection  
II - Dissecting  
II - Disección

Sans griffes  
Without teeth  
Sin dientes

12 cm - 4 <sup>3</sup>/<sub>4</sub> " **B408500**

15 cm - 6 " **B408510**

1 x 2 griffes  
1 x 2 teeth  
1 x 2 dientes

12 cm - 4 <sup>3</sup>/<sub>4</sub> " **B408501**

15 cm - 6 " **B408511**



**B408510**  
15 cm - 6 "



**B408511**  
15 cm - 6 "

# LANDANGER

## Pinces à dissection spéciales - Special dissection forceps - Pinzas para disección especiales



### PINCES À ÉCHARDES SPLINTERS FORCEPS PINZAS PARA ASTILLAS

### MICRO-PINCE À SUTURE SUTURE MICRO FORCEPS MICRO PINZA PARA SUTURA

	Droite Straight Recta	Courbe Curve Curva	Droite Straight Recta	Courbe Curve Curva		Droite Straight Recta	Courbe Curve Curva
10,5 cm - 4 "	<b>B410010</b>	<b>B410020</b>	<b>B410030</b>	<b>B410040</b>	12 cm - 4 3/4 "	<b>B408801</b>	-
11,5 cm - 4 1/2 "	<b>B410011</b>	<b>B410021</b>	<b>B410031</b>	<b>B410041</b>	13,5 cm - 5 1/4 "	<b>B408802</b>	<b>B408804</b>



Lisse  
Smooth  
Liso

**B410011**  
11,5 cm - 4 1/2 "



Strié  
Serrated  
Estrizado

**B410041**  
11,5 cm - 4 1/2 "



**B408802**  
13,5 cm - 5 1/4 "



**B408804**  
13,5 cm - 5 1/4 "

II - Dissection  
II - Dissecting  
II - Disección

# LANDANGER

## Pinces à dissection spéciales - Special dissection forceps - Pinzas para disección especiales



### DUMONT

II - Dissection  
II - Dissecting  
II - Disección



N° 1

**B408701**  
11 cm - 4 1/4 "



N° 2

**B408702**  
11 cm - 4 1/4 "



N° 3

**B408703**  
11 cm - 4 1/4 "



N° 4

**B408704**  
11 cm - 4 1/4 "



N° 5

**B408705**  
11 cm - 4 1/4 "

## PINCES À ÉCHARDES - SPLINTERS FORCEPS - PINZAS PARA ASTILLAS

### FEILCHENFELD



**B410100**  
7,5 cm - 3 "  
**B410101**  
9 cm - 3 1/2 "  
**B410102**  
11,5 cm - 4 1/2 "

### HUNTER



Droite  
Straight  
Recta

**B410110**  
10,5 cm - 4 "



Courbe  
Curved  
Curva

**B410111**  
10,5 cm - 4 "

### WALTER-CARMALT



Droite  
Straight  
Recta

**B410120**  
10,5 cm - 4 "



Courbe  
Curved  
Curva

**B410121**  
10,5 cm - 4 "





Sans griffes  
Without teeth  
Sin dientes

Mors 8/10  
8/10 jaws  
Bocas 8/10



**I150890**  
10 cm - 4"



**I150895**  
10 cm - 4"

Sans griffes  
Without teeth  
Sin dientes



**I15120**  
11 cm - 4 1/4"

A griffes  
With teeth  
Con dientes



**I15110**  
11 cm - 4 1/4"

### TROELTSCH

Sans griffes - Without teeth - Sin dientes



Mors striés  
Serrated jaws  
Boca estriada

14 cm - 5 1/2"

I15050

17 cm - 6 3/4"

I150501



Mors lisses  
Smooth jaws  
Boca lisa

14 cm - 5 1/2"

I150502

17 cm - 6 3/4"

I150503



Mors fins  
Fine jaws  
Boca fina

14 cm - 5 1/2"

I150504

17 cm - 6 3/4"

I150505

A griffes - With teeth - Con dientes



Moyen  
Medium  
Medio

14 cm - 5 1/2"

I15060

17 cm - 6 3/4"

I150601

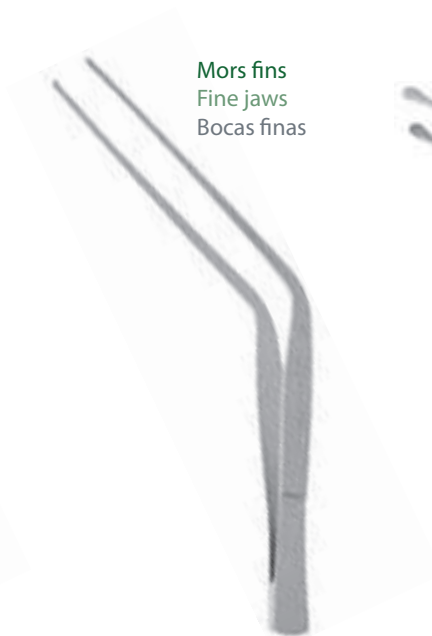

Mors fins  
Fine jaws  
Bocas finas

14 cm - 5 1/2"

I150602

17 cm - 6 3/4"

I150603



Mors cuillères  
Spoon jaws  
Boca cuchara

14 cm - 5 1/2"

I150604

17 cm - 6 3/4"

I150605

POLITZER

Sans griffes  
Without teeth  
Sin dientes

A griffes  
With teeth  
Con dientes

Mors cuillères  
Spoon jaws  
Boca cuchara



**I150610**  
14 cm - 5 1/2"



**I150611**  
14 cm - 5 1/2"



**I150612**  
14 cm - 5 1/2"



LUCAE

II - Dissection  
II - Dissecting  
II - Disección

Sans griffes  
Without teeth  
Sin dientes



**I150620**  
14 cm - 5 1/2 "

**I150640**  
17 cm - 6 3/4 "

1 x 2 griffes  
1 x 2 teeth  
1 x 2 dientes



**I150621**  
14 cm - 5 1/2 "

Mors cuillères  
Spoon jaws  
Boca cuchara



**I150630**  
14 cm - 5 1/2 "

# LANDANGER

## Pinces à dissection vasculaire - Vascular dissection forceps - Pinzas para disección vasculares



Mors DeBakey  
DeBakey Jaws  
Boca DeBakey



### DEBAKEY

	1,5 mm
16 cm - 6 1/4"	C10005
20 cm - 8"	C10010
24 cm - 9 1/2"	C10012
30 cm - 11 3/4"	C10013

	2,0 mm
16 cm - 6 1/4"	C10015
20 cm - 8"	C10020
24 cm - 9 1/2"	C10025
30 cm - 11 3/4"	C10027

	2,0 mm
16 cm - 6 1/4"	C10030
20 cm - 8"	C10035
24 cm - 9 1/2"	C10040
30 cm - 11 3/4"	C10047

Droite  
Straight  
Recta

Coudée  
Angled  
Angulada



C10005  
16 cm - 6 1/4"



C10010  
20 cm - 8"



C10015  
16 cm - 6 1/4"



C10020  
20 cm - 8"



C10030  
16 cm - 6 1/4"



C10035  
20 cm - 8"

II - Dissection  
II - Dissecting  
II - Disección

# LANDANGER

## Pinces à dissection vasculaire - Vascular dissection forceps - Pinzas para disección vasculares



Mors DeBailey  
DeBailey Jaws  
Boca DeBailey

**2,7 mm**

- 16 cm - 6 1/4" **C10041**
- 20 cm - 8" **C10042**
- 24 cm - 9 1/2" **C10043**
- 30 cm - 11 3/4" **C10044**

### DE BAKEY

**3,5 mm**

- 16 cm - 6 1/4" **C10045**
- 20 cm - 8" **C10050**
- 24 cm - 9 1/2" **C10055**
- 30 cm - 11 3/4" **C10057**



Mors Cooley  
Cooley Jaws  
Boca Cooley

### COOLEY

**2,0 mm**

- 16 cm - 6 1/4" **C10765**
- 20 cm - 8" **C10770**



**C10041**  
16 cm - 6 1/4"



**C10042**  
20 cm - 8"



**C10045**  
16 cm - 6 1/4"



**C10050**  
20 cm - 8"



**C10770**  
20 cm - 8"

II - Dissection  
II - Dissecting  
II - Disección

# LANDANGER

Pinces à dissection mors tungstène - Dissection forceps with tungsten jaws - Pinzas para disección boca de tungsteno



STANDARD  
STANDARD  
ESTÁNDAR

14 cm - 5 1/2 "	B40610
16 cm - 6 1/4 "	B40620
18 cm - 7 "	B40640
20 cm - 8 "	B40650
25 cm - 10 "	B40660
30 cm - 11 3/4 "	B40670

ADSON



**B40600**  
12 cm - 4 3/4 "



**B40610**  
14 cm - 5 1/2 "



**B40620**  
16 cm - 6 1/4 "



**B40640**  
18 cm - 7 "



**B40650**  
20 cm - 8 "

II - Dissection  
II - Dissecting  
II - Disección

# LANDANGER

Pinces à dissection mors tungstène - Dissection forceps with tungsten jaws - Pinzas para disección boca de tungsteno



## POTTS-SMITH

18 cm - 7 "

**B40760**

21 cm - 8 1/4 "

**B40770**

25 cm - 10 "

**B40780**



**B40760**  
18 cm - 7 "



**B40770**  
21 cm - 8 1/4 "

## CUSHING



**B40750**  
18 cm - 7 "



## EVANS



**B407900**  
25 cm - 9 3/4 "

II - Dissection  
II - Dissecting  
II - Disección



# LANDANGER

Pinces à dissection Prestige - Prestige dissection forceps - Pinzas para disección Prestige



*Prestige*

II - Dissection  
II - Dissecting  
II - Disección

1 x 2 griffes  
1 x 2 teeth  
1 x 2 dientes

Sans griffes  
Without teeth  
Sin dientes

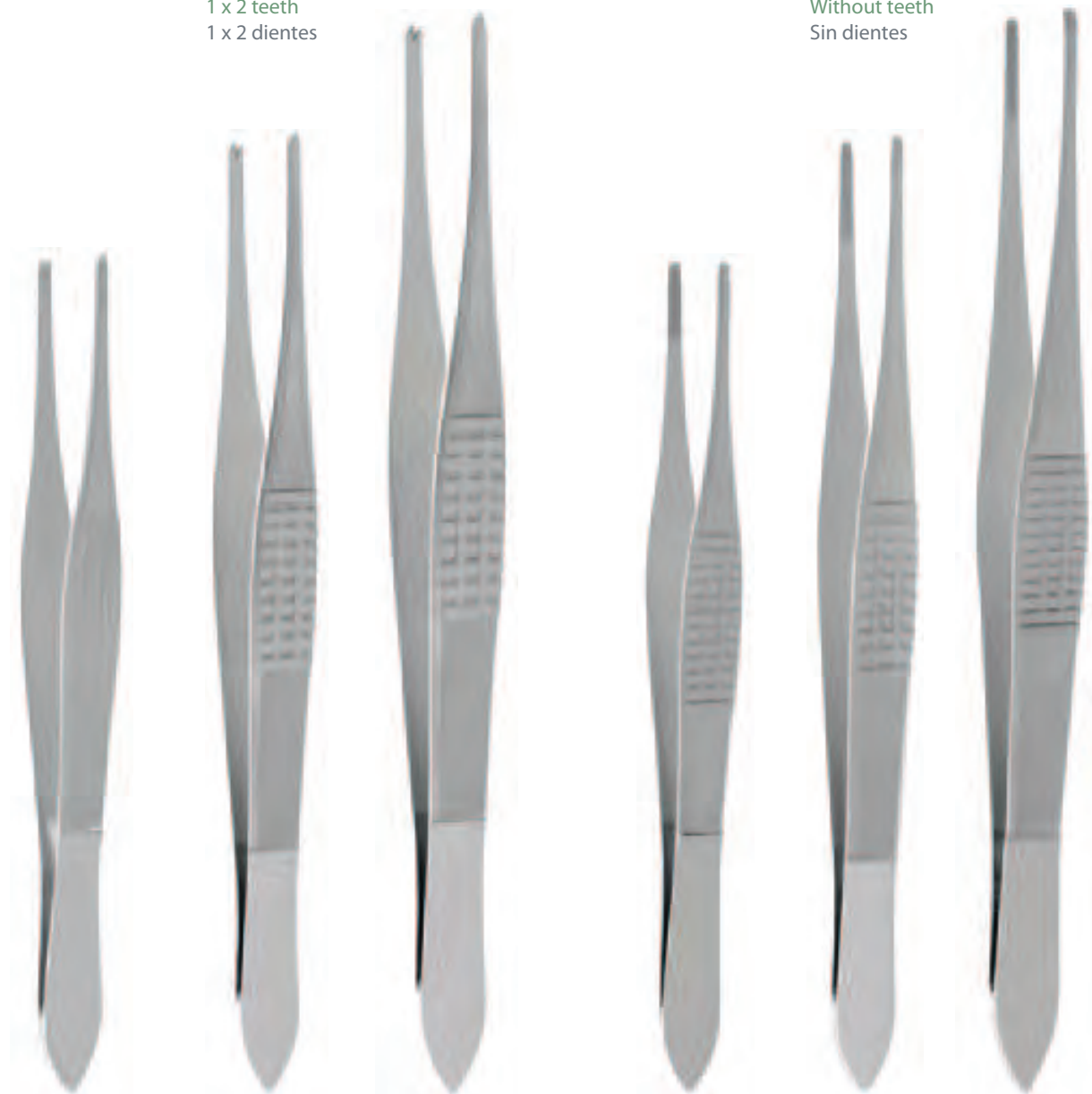

**B86700**  
14 cm - 5 1/2 "

**B86705**  
16 cm - 6 1/4 "

**B86710**  
18 cm - 7 "

**B86715**  
14 cm - 5 1/4 "

**B86720**  
16 cm - 6 1/4 "

**B86725**  
18 cm - 7 "

# LANDANGER

Pinces à dissection Prestige - Prestige dissection forceps - Pinzas para disección Prestige



*Prestige*

VINCENT

1 x 2 griffes  
1 x 2 teeth  
1 x 2 dientes

Sans griffes  
Without teeth  
Sin dientes

MODÈLE FIN  
FINE MODEL  
MODELO FINO

1 x 2 griffes  
1 x 2 teeth  
1 x 2 dientes

Sans griffes  
Without teeth  
Sin dientes



**B86730**  
14 cm - 5 1/2 "



**B86735**  
14 cm - 5 1/2 "



**B86740**  
20 cm - 8 "



**B86745**  
20 cm - 8 "

# LANDANGER

Pinces à dissection Prestige - Prestige dissection forceps - Pinzas para disección Prestige



*Prestige*

## BARRAYA

2 x 3 griffes, mors étroits - Quadrillés  
2 x 3 teeth, narrow jaws - Squared  
2 x 3 dientes, boca estrecha - Cuadriculada

## ADLERKREUTZ

3 x 4 griffes, à talon  
3 x 4 teeth, with heel  
3 x 4 dientes, con talon

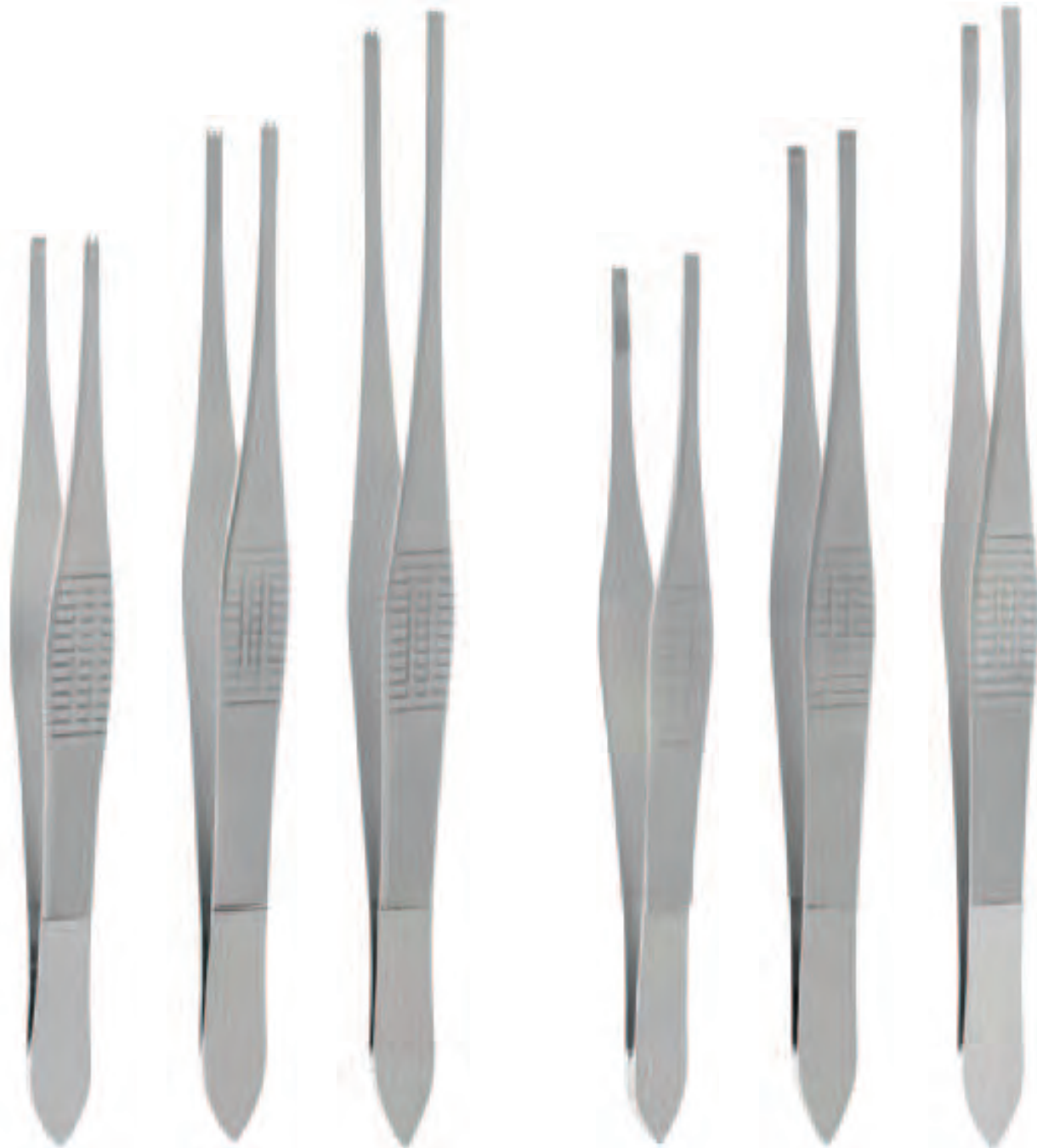

**B86750**  
16 cm - 6 1/4 "

**B86755**  
18 cm - 7 "

**B86760**  
20 cm - 8 "

**B86765**  
16 cm - 6 1/4 "

**B86770**  
18 cm - 7 "

**B86775**  
20 cm - 8 "

II - Dissection  
II - Dissecting  
II - Disección

# LANDANGER

Pinces à dissection Prestige - Prestige dissection forceps - Pinzas para disección Prestige

*Prestige*



**DURAND**

**PATTE DE VELOURS  
RUSSIAN MODEL  
MODELO RUSO**



**B86780**  
15 cm - 5 <sup>3</sup>/<sub>4</sub> "



**B86785**  
20 cm - 8 "

II - Dissection  
II - Dissecting  
II - Disección

**II - 40**

Ciseaux chirurgicaux - Surgical scissors - Tijeras quirúrgicas

**Mousse-Mousse**  
Blunt-Blunt  
Roma-Roma

**Pointu-Pointu**  
Sharp-Sharp  
Aguda-Aguda

**DAUPHIN**



P 1



P 2



P 3

Ciseaux délicats - Delicate scissors - Tijeras delicadas

**Strabisme**  
Strabismus  
Estrabismo

**Cataracte**  
Cataract  
Catarata

**Enucleation**  
Enucleation  
Enucleacion

**WAGNER**

**ALLAIRE**

**KILNER**  
(RAGNELL)



P 4



☒



Ciseaux à dissection - Dissecting scissors - Tijeras para disección

**MAYO**

**MAYO-STILLE**

**MAYO-ALSACE**

**MAYO-LEGER**

**MAYO-LYON**

**MAYO-NOBLE**

**MAYO-SANTY**

**MAYO-HARRINGTON**

**DUBOST**



P 7



**BABY-LEXER**

**LEXER**

**METZENBAUM**

**METZENBAUM-FINO**

**ALLAINE**



P 12



P 12



P 13



P 14



☒



Ciseaux divers - Miscellaneous scissors - Tijeras diversas

**HI-LEVEL**  
**NANCY**  
(KNOWLES)

**DOYEN**

**VINCENT**

**BOETCHER**

**KLIKENBERG**

**SATINSKY**

**SIEBOLD**

**ROUENNAIS**

**JESCO**



P 18



P 18



P 18



P 25



P 25



P 34



☒



Ciseaux à pansements - Bandage scissors - Tijeras para vendajes

**LISTER**



P 19

Ciseaux pour couper les fils - Wire cutting scissors - Tijeras para cortar hilos

**HARVEY    UNIVERSEL    BEEBE**



P 20

P 20

P 20

III - Ciseaux  
III - Scissors  
III - Tijeras

Ciseaux pour chirurgie vasculaire - Scissors for vascular surgery - Tijeras para cirugía vascular

**POTTS-SMITH    DE BAKEY    HEGEMANN (DIETRICH)    POTTS DE MARTEL    CORONAIRES    DE MARTEL**

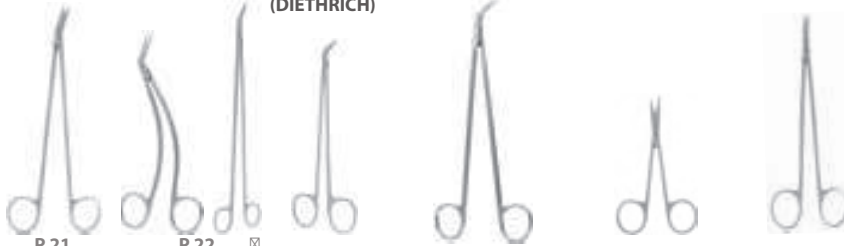

P 21

P 22

☒

Ciseaux fins - Fine scissors - Tijeras finas

**LA GRANGE    MICRO    KNAPP    STEVENS    GOLDMANN FOX    LOCKLIN    JAMESON    REYNOLDS    TOENNIS    TOENNIS-ADSON    KELLY    STRULLY**



P

Ciseaux coupe ligatures - Ligature cutting scissors - Tijeras para cortar ligaduras

**SPENCER    LITTAUER    SPENCER-FINO**



P 27

P 28

P 28

Ciseaux pour intervention en profondeur - Scissors for deep operations - Tijeras para intervenci3n a fondo

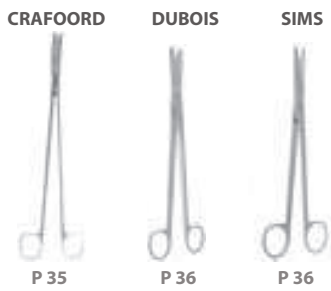

Ciseaux en tungst3ne - Tungsten scissors - Tijeras de tungsteno

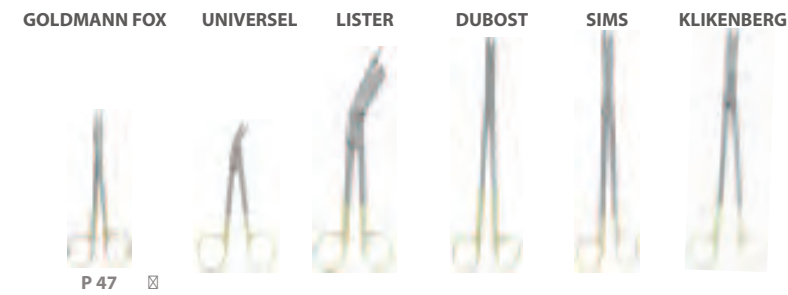
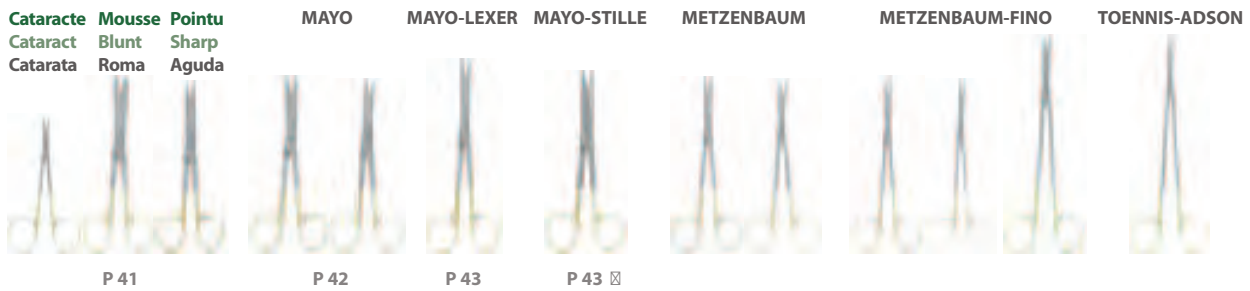

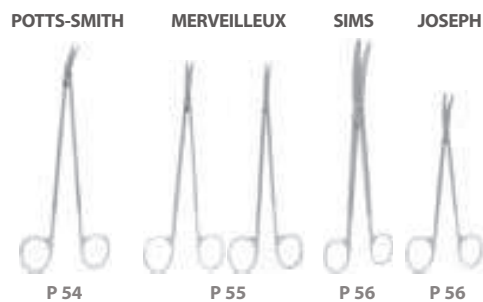

Ciseaux Prestige - Prestige scissors - Tijeras Prestige





VIII - Voies basses  
VIII - Gyne/Uro/Procto  
VIII - Gyne/Uro/Procto

Ciseaux divers - Miscellaneous scissors - Tijeras diversas



<b>BUSCH</b>	Pour le cordon ombilical For umbilical cord Para el cordon umbilical	Vaginal (type Mayo) Vaginal (style Mayo) Vaginal (tipo Mayo)
		
P 65	P 65	P 67

Ciseaux à épisiotomie - Episiotomy scissors - Tijeras episiotomía

<b>DELESTRE</b>	<b>BRAUN-STADLER</b>	<b>WALDMANN</b>
		
P 66	P 66	P 67

X - Microchirurgie  
X - Microsurgery  
X - Microcirugía

Microchirurgie ciseaux - Microsurgery scissors - Microcirugía tijeras

<b>VANNAS</b>	<b>MICRO SCISSORS</b>	<b>YASARGIL</b>
		
P 6	P 7	P 8

XII - O.R.L.  
XII - E.N.T.  
XI - O.R.L.

O.R.L. - E.N.T. - O.R.L.  
JOSEPH

  
P 35

XIII - Osseux  
XIII - Bone surgery  
XIII - Cirugia osea

Pour décapsuler - To take capsules off  
Para decapsular









  
P 92

Pour ménisque - For meniscus  
Para menisco

  
P 109

XV - Divers  
XV - Miscellaneous  
XV - Diversos



Instrumentation de service - Instrumentation for services - Instrumentación de servicio

			<b>LISTER</b>				<b>MAYO</b>			<b>BRUNS</b>
										
P 6	P 10	P 10	P 10	☒						

Pour plâtre - For plaster  
Para escayolas

XV - Divers  
XV - Miscellaneous  
XV - Diversos

Accessoires - Accessories - Accesorios

<b>MAYO</b>	<b>LORTAT-JACOB</b>	<b>LANDANGER</b>
		
P 28	P 29	P 29



# LANDANGER

## Ciseaux chirurgicaux - Surgical scissors - Tijeras quirúrgicas



	Droit Straight Recta		Courbe Curved Curva	
11 cm - 4 1/4 "	<b>B25255</b>		11 cm - 4 1/4 "	<b>B25260</b>
13 cm - 5 "	<b>B25261</b>		13 cm - 5 "	<b>B25262</b>
14 cm - 5 1/2 "	<b>B25275</b>		14 cm - 5 1/2 "	<b>B25280</b>
16 cm - 6 1/4 "	<b>B25285</b>		16 cm - 6 1/4 "	<b>B25290</b>
18 cm - 7 "	<b>B25295</b>		18 cm - 7 "	<b>B25300</b>
20 cm - 8 "	<b>B25302</b>		20 cm - 8 "	<b>B25303</b>

III - Ciseaux  
III - Scissors  
III - Tijeras



**B25261**  
13 cm - 5 "

Mousse / Mousse  
Blunt / Blunt  
Roma / Roma



**B25262**  
13 cm - 5 "

# LANDANGER

## Ciseaux chirurgicaux - Surgical scissors - Tijeras quirúrgicas



III - Ciseaux  
III - Scissors  
III - Tijeras

	Droit Straight Recta		Courbe Curved Curva
11 cm - 4 1/4 "	<b>B25305</b>		11 cm - 4 1/4 " <b>B25310</b>
13 cm - 5 "	<b>B25311</b>		13 cm - 5 " <b>B25312</b>
14 cm - 5 1/2 "	<b>B25325</b>		14 cm - 5 1/2 " <b>B25330</b>
16 cm - 6 1/4 "	<b>B25335</b>		16 cm - 6 1/4 " <b>B25340</b>
18 cm - 7 "	<b>B25345</b>		18 cm - 7 " <b>B25350</b>



**B25311**  
13 cm - 5 "

Pointu / Pointu  
Sharp / Sharp  
Aguda / Aguda



**B25312**  
13 cm - 5 "

# LANDANGER

Ciseaux chirurgicaux - Surgical scissors - Tijeras quirúrgicas



## DAUPHIN

	Droit Straight Recta		Courbe Curved Curva	
11 cm - 4 1/4 "	<b>B25355</b>		11 cm - 4 1/4 "	<b>B25360</b>
13 cm - 5 "	<b>B25365</b>		13 cm - 5 "	<b>B25370</b>
14 cm - 5 1/2 "	<b>B25375</b>		14 cm - 5 1/2 "	<b>B25380</b>
16 cm - 6 1/4 "	<b>B25385</b>		16 cm - 6 1/4 "	<b>B25390</b>
18 cm - 7 "	<b>B25395</b>		18 cm - 7 "	<b>B25400</b>

III - Ciseaux  
III - Scissors  
III - Tijeras



**B25365**  
13 cm - 5 "

Pointu - Mousse  
Sharp - Blunt  
Aguda - Roma



**B25370**  
13 cm - 5 "

# LANDANGER

Ciseaux délicats - Delicate scissors - Tijeras delicadas



STRABISME  
STRABISMUS  
ESTRABISMO

CATARACTE  
CATARACT  
CATARATA

III - Ciseaux  
III - Scissors  
III - Tijeras

Droit  
Straight  
Recta

Courbe  
Curved  
Curva

Droit  
Straight  
Recta

Courbe  
Curved  
Curva

12 cm - 4 <sup>3</sup>/<sub>4</sub> "

**B25265**

**B25270**

12 cm - 4 <sup>3</sup>/<sub>4</sub> "

**B25315**

**B25320**



**B25265**  
12 cm - 4 <sup>3</sup>/<sub>4</sub> "



**B25315**  
12 cm - 4 <sup>3</sup>/<sub>4</sub> "

# LANDANGER

Ciseaux délicats - Delicate scissors - Tijeras delicadas



ENUCLEATION  
ENUCLEATION  
ENUCLEACION

WAGNER

Droit  
Straight  
Recta

13 cm - 5 " **B25402**  
14 cm - 5 1/2 " **B25405**

Courbe  
Curved  
Curva

13 cm - 5 " **B25403**  
14 cm - 5 1/2 " **B25410**

Droit  
Straight  
Recta

Courbe  
Curved  
Curva

12 cm - 4 3/4 " **B259620** **B259621**

Pointu / Mousse  
Sharp / Blunt  
Aguda / Roma



**B25402**  
13 cm - 5 "



**B25403**  
13 cm - 5 "



**B259621**  
12 cm - 4 3/4 "

III - Ciseaux  
III - Scissors  
III - Tijeras

III - 5

# LANDANGER

Ciseaux délicats - Delicate scissors - Tijeras delicadas



III - Ciseaux  
III - Scissors  
III - Tijeras

## ALLAIRE

Droit  
Straight  
Recta

Courbe  
Curved  
Curva

## KILNER (RAGNELL)

Courbe  
Curved  
Curva

12 cm - 4 <sup>3</sup>/<sub>4</sub> "

**B25421**

15 cm - 6 "

**B25426**

Spatulé  
Spatula  
Espatula

Spatulé  
Spatula  
Espatula



**B25415**  
13 cm - 5 "



**B25418**  
13 cm - 5 "



**B25421**  
12 cm - 4 <sup>3</sup>/<sub>4</sub> "

**III - 6**

# LANDANGER

## Ciseaux à dissection - Dissecting scissors - Tijeras para disección



### MAYO

	Droit Straight Recta		Courbe Curved Curva	
15 cm - 6 "	<b>B25483</b>		15 cm - 6 "	<b>B25485</b>
17 cm - 6 <sup>3</sup> / <sub>4</sub> "	<b>B25486</b>		17 cm - 6 <sup>3</sup> / <sub>4</sub> "	<b>B25489</b>
19 cm - 7 <sup>1</sup> / <sub>2</sub> "	<b>B254891</b>		19 cm - 7 <sup>1</sup> / <sub>2</sub> "	<b>B254892</b>
23 cm - 9 "	<b>B254893</b>		23 cm - 9 "	<b>B254894</b>
28 cm - 11 "	<b>B255100</b>		28 cm - 11 "	<b>B255101</b>

III - Ciseaux  
III - Scissors  
III - Tijeras



**B25483**  
15 cm - 6 "

Lames plates  
Flat blades  
Hojas planas



**B25485**  
15 cm - 6 "

# LANDANGER

Ciseaux à dissection - Dissecting scissors - Tijeras para disección



## MAYO-STILLE

	Droit Straight Recta		Courbe Curved Curva	
15 cm - 6 "	<b>B25490</b>		15 cm - 6 "	<b>B25495</b>
17 cm - 6 <sup>3</sup> / <sub>4</sub> "	<b>B25497</b>		17 cm - 6 <sup>3</sup> / <sub>4</sub> "	<b>B25498</b>
19 cm - 7 <sup>1</sup> / <sub>2</sub> "	<b>B254981</b>		19 cm - 7 <sup>1</sup> / <sub>2</sub> "	<b>B254982</b>

Lames rondes  
Round blades  
Hojas redondas



**B25497**  
17 cm - 6 <sup>3</sup>/<sub>4</sub> "

**B25498**  
17 cm - 6 <sup>3</sup>/<sub>4</sub> "



# LANDANGER

Ciseaux à dissection - Dissecting scissors - Tijeras para disección



## MAYO-ALSACE

## MAYO-LEGER

## MAYO-LYON

Droit  
Straight  
Recta

Courbe  
Curved  
Curva

Droit  
Straight  
Recta

Courbe  
Curved  
Curva

16 cm - 6 1/2 "

**B25460**

**B25465**

17 cm - 6 3/4 "

**B25470**

**B25475**



Lames évidées  
Hollowed blades  
Hojas vaciadas

Coudé  
Angular  
Angulada

**B25460**

16 cm - 6 1/4 "

**B25470**

17 cm - 6 3/4 "

**B25480**

14 cm - 5 1/2 "

III - Ciseaux  
III - Scissors  
III - Tijeras

# LANDANGER

## Ciseaux à dissection - Dissecting scissors - Tijeras para disección



### MAYO-NOBLE

### MAYO-SANTY

### MAYO-HARRINGTON

Droit  
Straight  
Recta

Courbe  
Curved  
Curva

Droit  
Straight  
Recta

Courbe  
Curved  
Curva

Droit  
Straight  
Recta

Courbe  
Curved  
Curva

17 cm - 6 3/4 "

**B255800**

**B255801**

24 cm - 9 1/2 "

**B25600**

**B25605**

20 cm - 8 "

**B25572**

**B25574**

23 cm - 9 "

**B25576**

**B25578**

III - Ciseaux  
III - Scissors  
III - Tijeras

Lames rondes  
Round blades  
Hojas redondas



**B255801**  
17 cm - 6 3/4 "



**B25600**  
24 cm - 9 1/2 "



**B25576**  
23 cm - 9 "

**III - 10**

# LANDANGER

Ciseaux à dissection - Dissecting scissors - Tijeras para disección



## DUBOST

	Droit Straight Recta	Courbe Curved Curva
23 cm - 9 "	<b>B25686</b>	<b>B25688</b>
26 cm - 10 1/4 "	<b>B25692</b>	<b>B25694</b>
30 cm - 11 3/4 "	<b>B25696</b>	<b>B25700</b>



**B25686**  
23 cm - 9 "

III - Ciseaux  
III - Scissors  
III - Tijeras

# LANDANGER

Ciseaux à dissection - Dissecting scissors - Tijeras para disección



## BABY-LEXER

## LEXER

Droit  
Straight  
Recta

Courbe  
Curved  
Curva

Droit  
Straight  
Recta

Courbe  
Curved  
Curva

10 cm - 4 "

**B256070**

**B256071**

16 cm - 6 <sup>1</sup>/<sub>4</sub> "

**B256080**

**B256081**

III - Ciseaux  
III - Scissors  
III - Tijeras



**B256070**

10 cm - 4 "



**B256080**

16 cm - 6 <sup>1</sup>/<sub>4</sub> "

**III - 12**

# LANDANGER

Ciseaux à dissection - Dissecting scissors - Tijeras para disección

## METZENBAUM



	Droit Straight Recta		Courbe Curved Curva	
12 cm - 4 <sup>3</sup> / <sub>4</sub> "	<b>B25610</b>		12 cm - 4 <sup>3</sup> / <sub>4</sub> "	<b>B25615</b>
15 cm - 6 "	<b>B25620</b>		15 cm - 6 "	<b>B25625</b>
18 cm - 7 "	<b>B25630</b>		18 cm - 7 "	<b>B25635</b>
20 cm - 8 "	<b>B25640</b>		20 cm - 8 "	<b>B25645</b>
23 cm - 9 "	<b>B25650</b>		23 cm - 9 "	<b>B25655</b>
25 cm - 10 "	<b>B25660</b>		25 cm - 10 "	<b>B25665</b>
28 cm - 11 "	<b>B25670</b>		28 cm - 11 "	<b>B25675</b>
30 cm - 11 <sup>3</sup> / <sub>4</sub> "	<b>B25680</b>		30 cm - 11 <sup>3</sup> / <sub>4</sub> "	<b>B25685</b>

III - Ciseaux  
III - Scissors  
III - Tijeras



**B25620**  
15 cm - 6 "

Mousse / Mousse  
Blunt / Blunt  
Roma / Roma



**B25625**  
15 cm - 6 "

# LANDANGER

Ciseaux à dissection - Dissecting scissors - Tijeras para disección



## METZENBAUM

	Droit Straight Recta		Courbe Curved Curva
15 cm - 6 "	<b>B256201</b>		<b>B256251</b>
18 cm - 7 "	<b>B256301</b>		<b>B256351</b>
20 cm - 8 "	<b>B256401</b>		<b>B256451</b>
23 cm - 9 "	<b>B256501</b>		<b>B256551</b>

III - Ciseaux  
III - Scissors  
III - Tijeras



**B256201**  
15 cm - 6 "

Pointu / Mousse  
Sharp / Blunt  
Aguda / Roma



**B256251**  
15 cm - 6 "

## METZENBAUM-FINO

	Droit Straight Recta		Courbe Curved Curva	
15 cm - 6 "	<b>B256205</b>		15 cm - 6 "	<b>B256255</b>
18 cm - 7 "	<b>B256305</b>		18 cm - 7 "	<b>B256355</b>
20 cm - 8 "	<b>B256405</b>		20 cm - 8 "	<b>B256455</b>
23 cm - 9 "	<b>B256505</b>		23 cm - 9 "	<b>B256555</b>
25 cm - 10 "	<b>B256605</b>		25 cm - 10 "	<b>B256655</b>
28 cm - 11 "	<b>B256705</b>		28 cm - 11 "	<b>B256760</b>
			28 cm - 11 "	<b>B256770</b> Short blades

III - Ciseaux  
III - Scissors  
III - Tijeras



**B256205**  
15 cm - 6 "

Mousse / Mousse  
Blunt / Blunt  
Roma / Roma



**B256255**  
15 cm - 6 "

# LANDANGER

Ciseaux à dissection - Dissecting scissors - Tijeras para disección



## ALLAINE

Droit  
Straight  
Recta

18 cm - 7 "

**B25705**

20 cm - 8 "

**B25715**

23 cm - 9 "

**B25725**

Courbe  
Curved  
Curva

18 cm - 7 "

**B25706**

20 cm - 8 "

**B25716**

23 cm - 9 "

**B25726**



**B25705**  
18 cm - 7 "



**B25706**  
18 cm - 7 "



# LANDANGER

Ciseaux à dissection - Dissecting scissors - Tijeras para disección



## ALLAINE

- 18 cm - 7 " **B25707**
- 20 cm - 8 " **B25717**
- 23 cm - 9 " **B25727**



Double courbure  
Double curvature  
Doble curvatura

**B25707**  
18 cm - 7 "

**B25717**  
20 cm - 8 "

III - Ciseaux  
III - Scissors  
III - Tijeras

# LANDANGER

Ciseaux divers - Various scissors - Tijeras diversas



## HI-LEVEL (KNOWLES)

Coudé  
Angular  
Angulada



**B25770**  
14 cm - 5 1/2 "

## NANCY

Courbe  
Curved  
Curva



**B25775**  
18,5 cm - 7 1/4 "

## DOYEN

Droit  
Straight  
Recta

Courbe  
Curved  
Curva

18 cm - 7 "

**B257610**

**B257615**



**B257610**  
18 cm - 7 "

III - Ciseaux  
III - Scissors  
III - Tijeras

# LANDANGER

Ciseaux à pansements - Bandage scissors - Tijeras para vendajes



## LISTER

Croix rouge  
Red cross  
Cruz roja

14 cm - 5 1/2 "	<b>B25745</b>
18 cm - 7 "	<b>B25737</b>
20 cm - 8 "	<b>B25740</b>



**B25745**  
14 cm - 5 1/2 "



**B25737**  
18 cm - 7 "

III - Ciseaux  
III - Scissors  
III - Tijeras

# LANDANGER

Ciseaux pour couper les fils - Wire cutting scissors - Tijeras para cortar hilos



HARVEY

UNIVERSEL

BEEBE

III - Ciseaux  
III - Scissors  
III - Tijeras

Droit  
Straight  
Recta

Courbe  
Curved  
Curva

10 cm - 4 "

**B258445**

**B25845**



Lames dentelées  
Serrated blades  
Hojas serradas

**B25780**  
12 cm - 4 3/4 "



Lames dentelées  
Serrated blades  
Hojas serradas

**B25786**  
12 cm - 4 3/4 "



Lames dentelées  
Serrated blades  
Hojas serradas

**B25845**  
10 cm - 4 "

**III - 20**

# LANDANGER

Ciseaux pour chirurgie vasculaire - Scissors for vascular surgery - Tijeras para cirugía vascular



## POTTS-SMITH



25°

**B25802**  
19 cm - 7 1/2 "

45°



**B25804**  
19 cm - 7 1/2 "

60°



**B25806**  
19 cm - 7 1/2 "

125°



**B25812**  
19 cm - 7 1/2 "

III - Ciseaux  
III - Scissors  
III - Tijeras

# LANDANGER

Ciseaux pour chirurgie vasculaire - Scissors for vascular surgery - Tijeras para cirugía vascular



## DE BAKEY

	25°	45°	60°
16 cm - 7 1/2 "	B258023	B258043	B258063
23 cm - 9 "	B258024	B258044	B258064
28 cm - 11 "	B258025	B258045	B258065

III - Ciseaux  
III - Scissors  
III - Tijeras

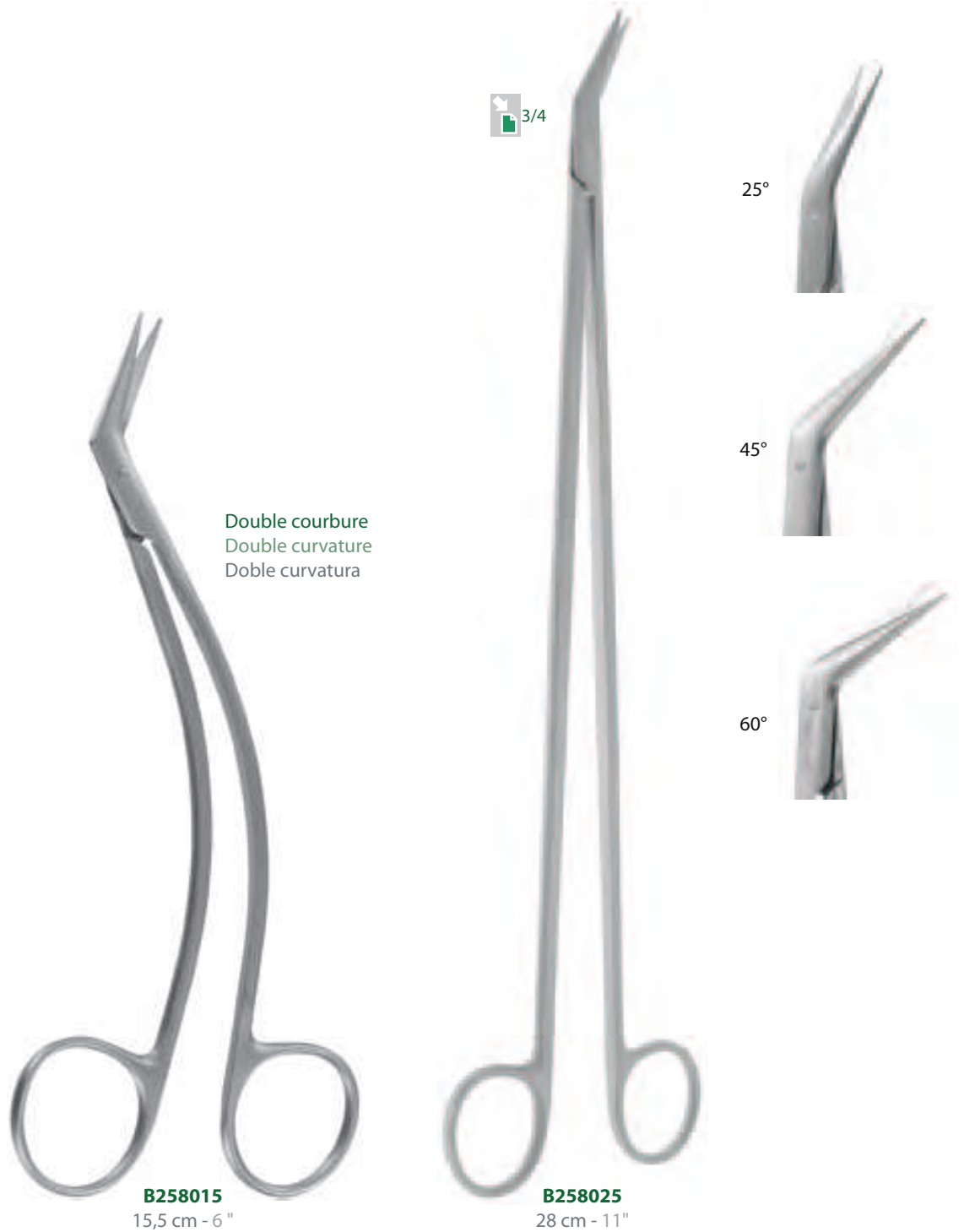

III - 22

# LANDANGER

Ciseaux pour chirurgie vasculaire - Scissors for vascular surgery - Tijeras para cirugía vascular

## HEGEMANN (DIETRICH)



	25°	45°	60°	90°	125°
13,5 cm - 5 1/4 "	B258027	B258047	B258067	B258107	-
16 cm - 6 1/4 "	B258028	B258048	B258068	B258108	B258128
19 cm - 7 1/2 "	B258029	B258049	B258069	B258109	B258129



25°



90°



45°



125°



60°



**B258048**  
16 cm - 6 1/4 "

III - Ciseaux  
III - Scissors  
III - Tijeras

# LANDANGER

Ciseaux pour chirurgie vasculaire - Scissors for vascular surgery - Tijeras para cirugía vascular



POTTS DE MARTEL

DE MARTEL

CORONAIRES

Droit  
Straight  
Recta

Courbe  
Curved  
Curva

45°

18 cm - 7 "

**B25813**

**B25814**



**B258121**  
21 cm - 8 1/4 "



**B25814**  
18 cm - 7 "



**B258150**  
11,5 cm - 4 1/2 "

III - Ciseaux  
III - Scissors  
III - Tijeras

**III - 24**



# LANDANGER

Ciseaux divers - Various scissors - Tijeras diversas



VINCENT  
(SCHMIEDEN)

BOETCHER



**B25820**  
17 cm - 6 <sup>3</sup>/<sub>4</sub> "



**B258491**  
18 cm - 7 "

III - Ciseaux  
III - Scissors  
III - Tijeras

# LANDANGER

Ciseaux fins - Fine scissors - Tijeras finas



## LA GRANGE

## MICRO

## KNAPP

III - Ciseaux  
III - Scissors  
III - Tijeras

	Droit Straight Recta	Courbe Curved Curva		Mousse-Mousse Blunt-Blunt Roma-Roma	Droit Straight Recta	Courbe Curved Curva
9 cm - 3 1/2 "	<b>B25816</b>	<b>B25817</b>		10,5 cm - 4 "	<b>B258180</b>	<b>B258181</b>
				Pointu-Mousse Sharp-Blunt Aguda-Roma	<b>B258182</b>	<b>B258183</b>
				Pointu-Pointu Sharp-Sharp Aguda-Aguda	<b>B258184</b>	<b>B258185</b>



**B258175**  
11,5 cm - 4 1/2 "



**B25816**  
9 cm - 3 1/2 "



**B258183**  
10,5 cm - 4 "

III - 26

# LANDANGER

Ciseaux coupe ligatures - Ligature cutting scissors - Tijeras para cortar ligaduras



## SPENCER

Droit  
Straight  
Recta

9 cm - 3 1/2 "

**B25825**

12 cm - 4 3/4 "

**B25835**

Courbe  
Curved  
Curva

9 cm - 3 1/2 "

**B25830**

12 cm - 4 3/4 "

**B25840**



**B25835**

12 cm - 4 3/4 "



**B25840**

12 cm - 4 3/4 "

III - Ciseaux  
III - Scissors  
III - Tijeras

# LANDANGER

Ciseaux coupe ligatures - Ligature cutting scissors - Tijeras para cortar ligaduras



LITTAUER

SPENCER-FINO



**B258410**  
14 cm - 5 1/2 "



**B258415**  
16 cm - 6 1/4 "

III - Ciseaux  
III - Scissors  
III - Tijeras

III - 28

# LANDANGER

Ciseaux fins - Fine scissors - Tijeras finas



## STEVENS

Droit  
Straight  
Recta

Courbe  
Curved  
Curva

11 cm - 4 1/4 "

**B25856**

**B25857**

Droit  
Straight  
Recta

Courbe  
Curved  
Curva

11 cm - 4 1/4 "

**B25858**

**B25859**

III - Ciseaux  
III - Scissors  
III - Tijeras



Mousse  
Blunt  
Roma

**B25856**

11 cm - 4 1/4 "



Pointu  
Sharp  
Aguda

**B25858**

11 cm - 4 1/4 "

# LANDANGER

Ciseaux fins - Fine scissors - Tijeras finas



**GOLDMANN-FOX**

**LOCKLIN**

CISEAUX À GENCIVES  
GINGIVA SCISSORS  
TIJERAS PARA ENCÍA

Droit      Courbe  
Straight    Curved  
Recta      Curva

13 cm - 5 "

**B258590**

**B258591**

III - Ciseaux  
III - Scissors  
III - Tijeras



Lames dentelées  
Serrated blades  
Hojas serradas

**B258590**  
13 cm - 5 "

**III - 30**



Coudé dentelé  
Angled serrated  
Angulada serradas

**B258595**  
16 cm - 6 1/4 "

**B258596**  
16 cm - 6 1/4 "

# LANDANGER

Ciseaux longs et fins - Long and fine scissors - Tijeras largas y finas



## JAMESON

Courbe  
Curved  
Curva



**B258495**  
15 cm - 6 "

## REYNOLDS

Courbe  
Curved  
Curva

15 cm - 6 "	<b>B25850</b>
18 cm - 7 "	<b>B25851</b>



**B25850**  
15 cm - 6 "

III - Ciseaux  
III - Scissors  
III - Tijeras

# LANDANGER

Ciseaux longs et fins - Long and fine scissors - Tijeras largas y finas



## TOENNIS

Droit  
Straight  
Recta

Courbe  
Curved  
Curva

18 cm - 7 "

**B25852**

**B25853**

## TOENNIS-ADSON

Courbe  
Curved  
Curva

III - Ciseaux  
III - Scissors  
III - Tijeras



Lames plates  
Flat blades  
Hojas planas

**B25852**  
18 cm - 7 "



Lames rondes  
Round blades  
Hojas redondas

**B258531**  
17,5 cm - 7 "

**III - 32**



# LANDANGER

Ciseaux longs et fins - Long and fine scissors - Tijeras largas y finas



## KELLY

Droit  
Straight  
Recta

Courbe  
Curved  
Curva

18 cm - 7 "

**B25847**

**B25848**

Pour fistule  
For fistula  
Para fistula

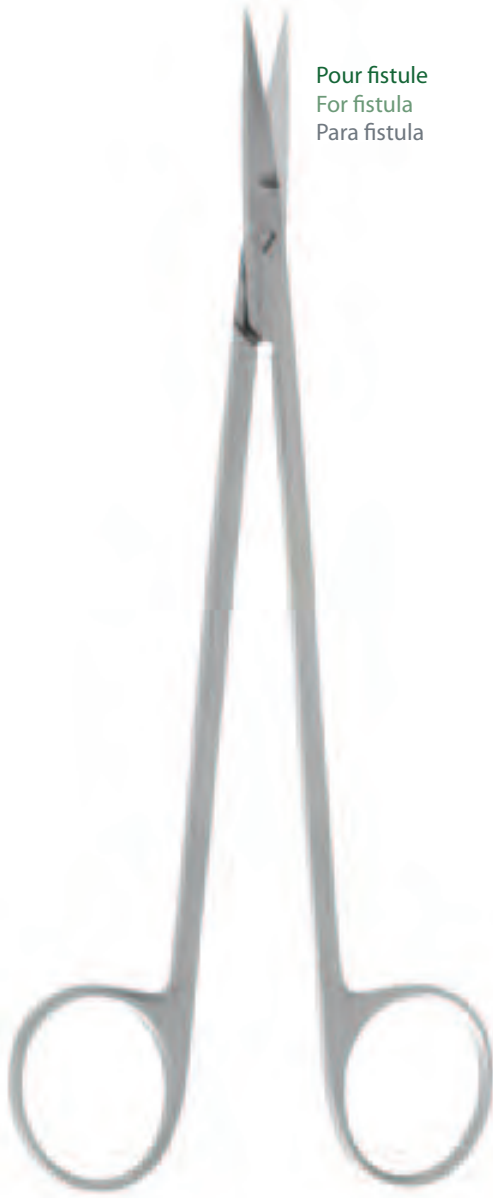

**B25847**  
18 cm - 7 "

## STRULLY

Courbe  
Curved  
Curva



**B258537**  
22 cm - 8 3/4 "

III - Ciseaux  
III - Scissors  
III - Tijeras

# LANDANGER

Ciseaux divers - Miscellaneous scissors - Tijeras diversas



KLIKENBERG

SATINSKY

SIEBOLD



Double courbure  
Double curvature  
Doble curvatura

Double courbure  
Double curvature  
Doble curvatura

**B25920**  
23 cm - 9 "

**B25925**  
24 cm - 9 1/2 "

**B25930**  
24 cm - 9 1/2 "

# LANDANGER

Ciseaux pour intervention en profondeur - Scissors for deep operation - Tijeras para intervención en profundidad

## CRAFOORD

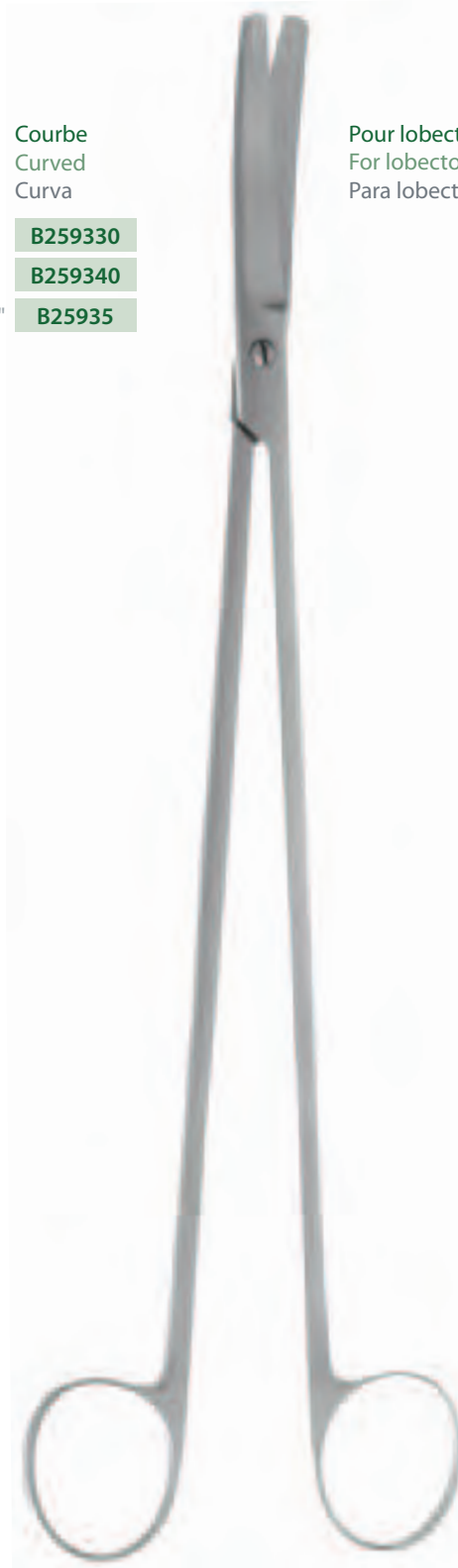

Courbe  
Curved  
Curva

Pour lobectomie  
For lobectomy  
Para lobectomía

23 cm - 9 "

**B259330**

25 cm - 10 "

**B259340**

30 cm - 11 <sup>3</sup>/<sub>4</sub> "

**B25935**

**B25935**  
30 cm - 11 <sup>3</sup>/<sub>4</sub> "

III - Ciseaux  
III - Scissors  
III - Tijeras

# LANDANGER

Ciseaux pour intervention en profondeur - Scissors for deep operation - Tijeras para intervención en profundidad



## DUBOIS

Droit  
Straight  
Recta

Courbe  
Curved  
Curva

27 cm - 10 1/2 "

**B25854**

**B25855**

## SIMS

Droit  
Straight  
Recta

Courbe  
Curved  
Curva

20 cm - 8 "

**F05100**

**F05110**

23 cm - 9 "

**F05160**

**F05120**



**B25854**

27 cm - 10 1/2 "



**F05100**

20 cm - 8 "

III - Ciseaux  
III - Scissors  
III - Tijeras

# LANDANGER

## Ciseaux divers - Miscellaneous scissors - Tijeras diversas

COIFFEUR  
HAIRDRESSER  
PELUQUERO

PRÉPARATION COLLEUR  
GLUER PREPARATION  
PREPARACIÓN ENCOLADOR



**B25860**  
15 cm - 6 "



**B25865**  
25 cm - 10 "



Acier chromé  
Chrome steel  
Acero cromado

# LANDANGER

## Ciseaux divers - Miscellaneous scissors - Tijeras diversas

1/1

LINGÈRE  
LINGERE  
LENCERA

COUTURIÈRE BANCAL  
WOBBLY DRESSMAKER  
MODISTA COJO

COUTURIÈRE  
DRESSMAKER  
MODISTA

III - Ciseaux  
III - Scissors  
III - Tijeras



**B25870**  
13 cm - 5 "



Acier chromé  
Chrome steel  
Acero cromado



**B25875**  
17 cm - 6 <sup>3</sup>/<sub>4</sub> "



Acier chromé  
Chrome steel  
Acero cromado



**B25880**  
20 cm - 8 "

III - 38

# LANDANGER

Ciseaux divers - Miscellaneous scissors - Tijeras diversas

CISEAUX POUR COTON  
COTTON SCISSORS  
TIJERAS PARA ALGODON

ROUENNAIS

Droit  
Straight  
Recta

12 cm - 4 3/4 "

**B25890**

15 cm - 6 "

**B25895**

17 cm - 6 3/4 "

**B25900**



**B25885**  
28 cm - 11 "



Acier chromé  
Chrome steel  
Acero cromado



**B25895**  
15 cm - 6 "

III - Ciseaux  
III - Scissors  
III - Tijeras

# LANDANGER

Ciseaux divers préparation - Miscellaneous scissors preparation - Tijeras diversas preparación



JESCO

Noir Black Negra	Vert Green Verde	Bleu Blue Azúl	Rouge Red Roja
------------------------	------------------------	----------------------	----------------------

14,5 cm - 5 <sup>3</sup> / <sub>4</sub> "	<b>B259040</b>	<b>B259041</b>	<b>B259042</b>	<b>B259043</b>
18 cm - 7 "	<b>B25905</b>	<b>B259051</b>	<b>B259052</b>	<b>B259053</b>

III - Ciseaux  
III - Scissors  
III - Tijeras



**B259040**  
14,5 cm - 5 <sup>3</sup>/<sub>4</sub> "



**B25905**  
18 cm - 7 "

III - 40



# LANDANGER

## Ciseaux en tungstène - Tungsten scissors - Tijeras de tungsteno



CATARACTE  
CATARACT  
CATARATA

	Droit Straight Recta	Courbe Curved Curva		Droit Straight Recta	Courbe Curved Curva		Droit Straight Recta	Courbe Curved Curva
11,5 cm - 4 1/2 "	<b>B35001</b>	<b>B35002</b>	14 cm - 5 1/2 "	<b>B35003</b>	<b>B35004</b>		<b>B35005</b>	<b>B35006</b>

III - Ciseaux  
III - Scissors  
III - Tijeras



Fin - Pointu  
Fine - Sharp  
Fina - Aguda

**B35001**  
11,5 cm - 4 1/2 "



Mousse - Mousse  
Blunt - Blunt  
Roma - Roma

**B35003**  
14 cm - 5 1/2 "



Pointu - Pointu  
Sharp - Sharp  
Aguda - Aguda

**B35005**  
14 cm - 5 1/2 "

# LANDANGER

Ciseaux en tungstène - Tungsten scissors - Tijeras de tungsteno



## MAYO

III - Ciseaux  
III - Scissors  
III - Tijeras

Droit  
Straight  
Recta

Courbe  
Curved  
Curva

14 cm - 5 1/2 " **B35042**  
17 cm - 6 3/4 " **B35044**  
23 cm - 9 " **B35046**

14 cm - 5 1/2 " **B35043**  
17 cm - 6 3/4 " **B35045**  
23 cm - 9 " **B35047**



Lames plates  
Flat blades  
Hojas planas

**B35042**  
14 cm - 5 1/2 "

**B35043**  
14 cm - 5 1/2 "

# LANDANGER

Ciseaux en tungstène - Tungsten scissors - Tijeras de tungsteno



## MAYO-LEXER

## MAYO-STILLE

Droit  
Straight  
Recta

Courbe  
Curved  
Curva

Droit  
Straight  
Recta

Courbe  
Curved  
Curva

16 cm - 6 1/4 "

**B35007**

**B35008**

15 cm - 6 "

**B35010**

**B35020**

17 cm - 6 3/4 "

**B35030**

**B35040**



**B35007**  
16 cm - 6 1/4 "



**B35010**  
15 cm - 6 "

Lames rondes  
Round blades  
Hojas redondas

III - Ciseaux  
III - Scissors  
III - Tijeras

# LANDANGER

Ciseaux en tungstène - Tungsten scissors - Tijeras de tungsteno



## METZENBAUM

III - Ciseaux  
III - Scissors  
III - Tijeras

		Droit Straight Recta			Courbe Curved Curva
Baby	11,5 cm - 4 1/2 "	<b>B35104</b>	Baby	11,5 cm - 4 1/2 "	<b>B35106</b>
	15 cm - 6 "	<b>B35110</b>		15 cm - 6 "	<b>B35120</b>
	18 cm - 7 "	<b>B35130</b>		18 cm - 7 "	<b>B35140</b>
	20 cm - 8 "	<b>B35150</b>		20 cm - 8 "	<b>B35160</b>
	23 cm - 9 "	<b>B35172</b>		23 cm - 9 "	<b>B35174</b>
	25 cm - 10 "	<b>B351750</b>		25 cm - 10 "	<b>B351751</b>
	28 cm - 11 "	<b>B351780</b>		28 cm - 11 "	<b>B351781</b>
	30 cm - 11 3/4 "	<b>B35250</b>		30 cm - 11 3/4 "	<b>B35240</b>



**B35110**  
15 cm - 6 "



**B35120**  
15 cm - 6 "

# LANDANGER

Ciseaux en tungstène - Tungsten scissors - Tijeras de tungsteno



## METZENBAUM-FINO

	Droit Straight Recta		Courbe Curved Curva
15 cm - 6 "	<b>B35048</b>	15 cm - 6 "	<b>B35049</b>
18 cm - 7 "	<b>B35050</b>	18 cm - 7 "	<b>B35060</b>
20 cm - 8 "	<b>B35070</b>	20 cm - 8 "	<b>B35080</b>
23 cm - 9 "	<b>B35090</b>	23 cm - 9 "	<b>B35100</b>
25 cm - 10 "	<b>B351010</b>	25 cm - 10 "	<b>B351011</b>
28 cm - 11 "	<b>B351020</b>	28 cm - 11 "	<b>B351021</b>



**B35048**  
15 cm - 6 "



**B35049**  
15 cm - 6 "

III - Ciseaux  
III - Scissors  
III - Tijeras

# LANDANGER

Ciseaux en tungstène - Tungsten scissors - Tijeras de tungsteno



## METZENBAUM-FINO

15 cm - 6 "	<b>B35228</b>
18 cm - 7 "	<b>B35230</b>
20 cm - 8 "	<b>B35232</b>
23 cm - 9 "	<b>B35234</b>

## TOENNIS-ADSON

III - Ciseaux  
III - Scissors  
III - Tijeras

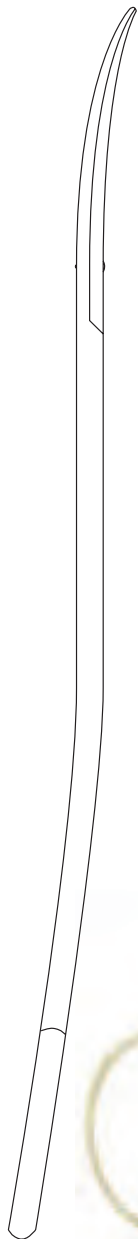

Double courbure  
Double curvature  
Doble curvatura

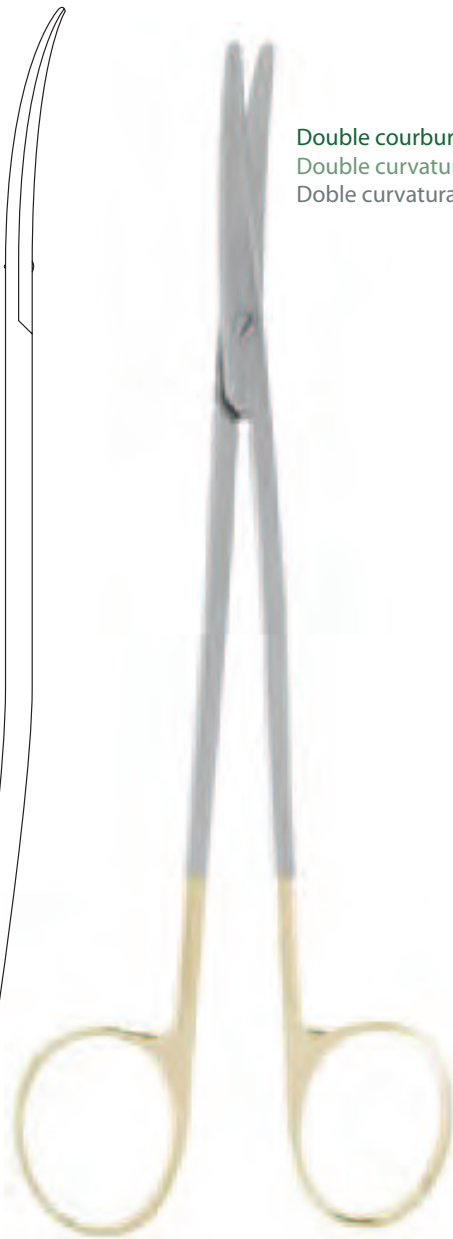

**B35230**  
18 cm - 7 "

Courbe  
Curved  
Curva



**B35260**  
18 cm - 7 "

**III - 46**

# LANDANGER

Ciseaux en tungstène - Tungsten scissors - Tijeras de tungsteno



**GOLDMANN-FOX**

**UNIVERSEL**

**LISTER**

Droit  
Straight  
Recta

Courbe  
Curved  
Curva

13 cm - 5 "

**B352580**

**B352581**

Croix rouge  
Red cross  
Cruz roja

Lames dentelées  
Serrated blades  
Hojas serradas

Lames dentelées  
Serrated blades  
Hojas serradas

**B35270**  
12 cm - 4 <sup>3</sup>/<sub>4</sub> "

**B352580**  
13 cm - 5 "

**B35280**  
18 cm - 7 "

III - Ciseaux  
III - Scissors  
III - Tijeras

# LANDANGER

Ciseaux en tungstène - Tungsten scissors - Tijeras de tungsteno

1/1

DUBOST



III - Ciseaux  
III - Scissors  
III - Tijeras

	Droit Straight Recta	Courbe Curved Curva
23 cm - 9 "	<b>B35180</b>	<b>B35190</b>
26 cm - 10 "	<b>B35200</b>	<b>B35210</b>



**B35180**  
23 cm - 9 "

III - 48



# LANDANGER

Ciseaux en tungstène - Tungsten scissors - Tijeras de tungsteno



SIMS

KLIKENBERG

23 cm - 9 "

Droit  
Straight  
Recta

**F05170**

Courbe  
Curved  
Curva

**F05175**



Double courbure  
Double curvature  
Doble curvatura

**B35220**  
23 cm - 9 "

III - Ciseaux  
III - Scissors  
III - Tijeras

# LANDANGER

Ciseaux Prestige - Prestige scissors - Tijeras Prestige



*Prestige*

## MAYO

## MAYO-STILLE

## MAYO-LEXER

	Droit Straight Recta	Courbe Curved Curva		Droit Straight Recta	Courbe Curved Curva		Droit Straight Recta	Courbe Curved Curva
15 cm - 6 "	<b>B86215</b>	<b>B86230</b>	15 cm - 6 "	<b>B86245</b>	<b>B86255</b>	16 cm - 6 1/4 "	<b>B86205</b>	<b>B86210</b>
17 cm - 6 3/4 "	<b>B86220</b>	<b>B86235</b>	17 cm - 6 3/4 "	<b>B86250</b>	<b>B86260</b>			
23 cm - 9 "	<b>B86225</b>	<b>B86240</b>						

III - Ciseaux  
III - Scissors  
III - Tijeras



III - 50

# LANDANGER

Ciseaux Prestige - Prestige scissors - Tijeras Prestige



*Prestige*

## BABY METZENBAUM

## METZENBAUM

## METZENBAUM-FINO

Droit  
Straight  
Recta

Courbe  
Curved  
Curva

Droit  
Straight  
Recta

Courbe  
Curved  
Curva

Droit  
Straight  
Recta

Courbe  
Curved  
Curva

11,5 cm - 4 1/2 "

**B86265**

**B86270**

14,5 cm - 5 3/4 "

**B86275**

**B86285**

14,5 cm - 5 3/4 "

**B86305**

**B86310**

18 cm - 7 "

**B86280**

**B86290**

18 cm - 7 "

-

**B86315**

20 cm - 8 "

-

**B86295**

20 cm - 8 "

-

-

23 cm - 9 "

-

**B86300**

23 cm - 9 "

-

**B86320**



**B86265**  
11,5 cm - 4 1/2 "



**B86275**  
14,5 cm - 5 3/4 "



**B86305**  
14,5 cm - 5 3/4 "

**III - 51**

III - Ciseaux  
III - Scissors  
III - Tijeras

# LANDANGER

Ciseaux Prestige - Prestige scissors - Tijeras Prestige



*Prestige*



## WAGNER

III - Ciseaux  
III - Scissors  
III - Tijeras

	Droit Straight Recta	Courbe Curved Curva		Droit Straight Recta	Courbe Curved Curva		Courbe Curved Curva
11,5 cm - 4 1/2 "	<b>B86325</b>	<b>B86330</b>	12 cm - 4 3/4 "	<b>B86335</b>	<b>B86340</b>	11 cm - 4 1/4 "	<b>B86345</b>
						14 cm - 5 1/2 "	<b>B86350</b>

## CATARACTE CATARACT CATARATA



III - 52

# LANDANGER

## Ciseaux Prestige - Prestige scissors - Tijeras Prestige



*Prestige*

### STEVENS

### REYNOLDS

### JAMESON

	Droit Straight Recta	Courbe Curved Curva		Droit Straight Recta	Courbe Curved Curva		Courbe Curved Curva
11,5 cm - 4 1/2"	<b>B86355</b>	<b>B86360</b>	13 cm - 5"	-	<b>B86365</b>	15 cm - 6"	<b>B86380</b>
			15 cm - 6"	<b>B86370</b>	<b>B86375</b>	18 cm - 7"	<b>B86385</b>

III - Ciseaux  
III - Scissors  
III - Tijeras



**B86355**  
11,5 cm - 4 1/2"

Lames mousses étroites  
Narrow blunt blades  
Hojas romas estrechas



**B86370**  
15 cm - 6"

Lames mousses étroites  
Narrow blunt blades  
Hojas romas estrechas



**B86380**  
15 cm - 6"

# LANDANGER

Ciseaux Prestige - Prestige scissors - Tijeras Prestige



*Prestige*



POTTS-SMITH

III - Ciseaux  
III - Scissors  
III - Tijeras

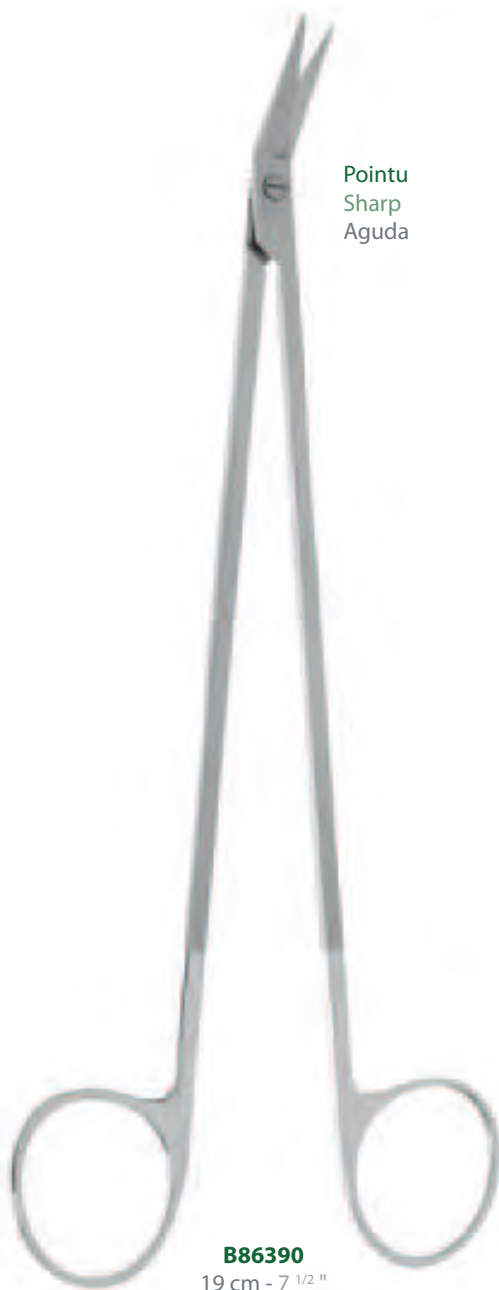

Pointu  
Sharp  
Aguda

**B86390**  
19 cm - 7 1/2 "



25°

**B86390**  
19 cm - 7 1/2 "



45°

**B86395**  
19 cm - 7 1/2 "



60°

**B86400**  
19 cm - 7 1/2 "

III - 54

# LANDANGER

Ciseaux Prestige - Prestige scissors - Tijeras Prestige



*Prestige*

MERVEILLEUX

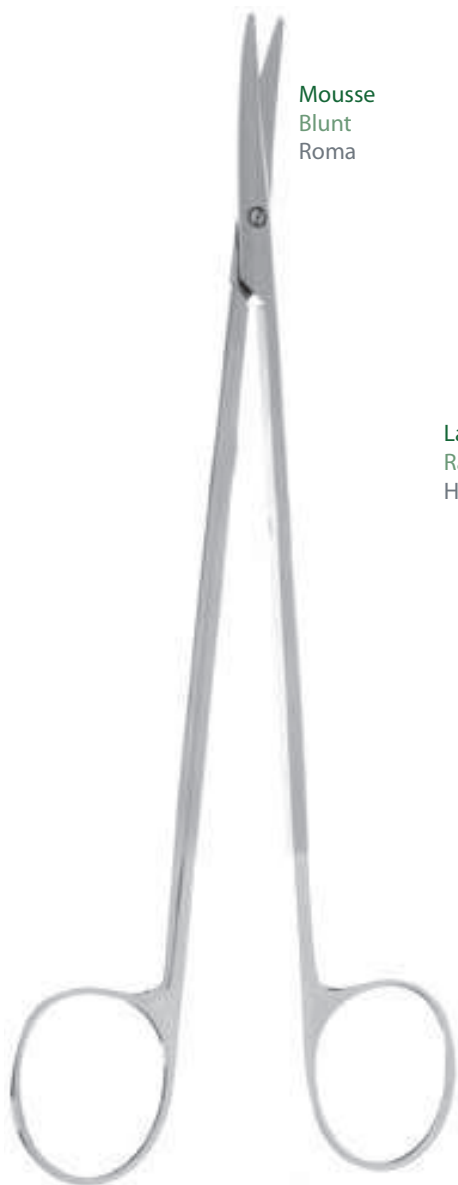

Mousse  
Blunt  
Roma

**B864020**  
17,5 cm - 6 3/4"

Lames rasoir - Courbe  
Razor blades - Curved  
Hojas navajas - Curva



Pointu  
Sharp  
Aguda

**B864025**  
17,5 cm - 6 3/4"

III - Ciseaux  
III - Scissors  
III - Tijeras

# LANDANGER

Ciseaux Prestige - Prestige scissors - Tijeras Prestige



SIMS

*Prestige*

JOSEPH



III - Ciseaux  
III - Scissors  
III - Tijeras



**B86420**  
23 cm - 9 "

**III - 56**

Droit	Courbe
Straight	Curved
Recta	Curva

20 cm - 8 "

**B86410**

**B86415**

23 cm - 9 "

-

**B86420**



**B86425**  
15 cm - 5 3/4 "



Pincès à pansements - Bandage forceps - Pinzas para vendajes

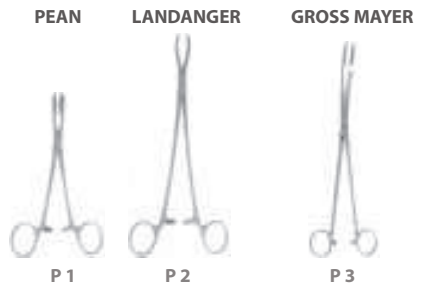

Pincès hémostatiques - Haemostatic forceps - Pinzas hemostáticas

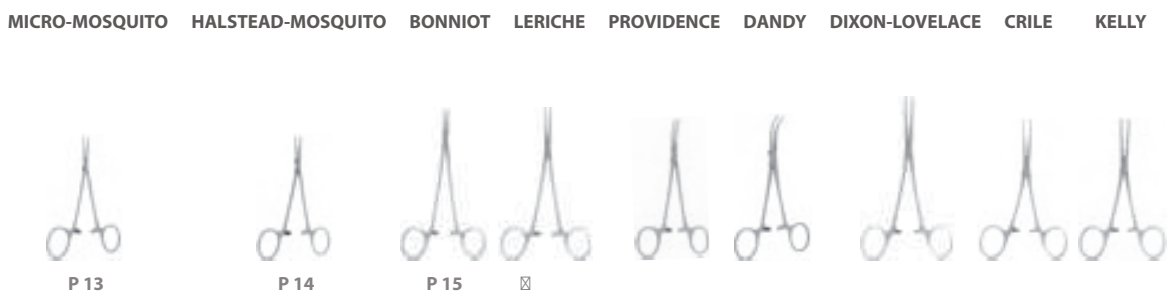
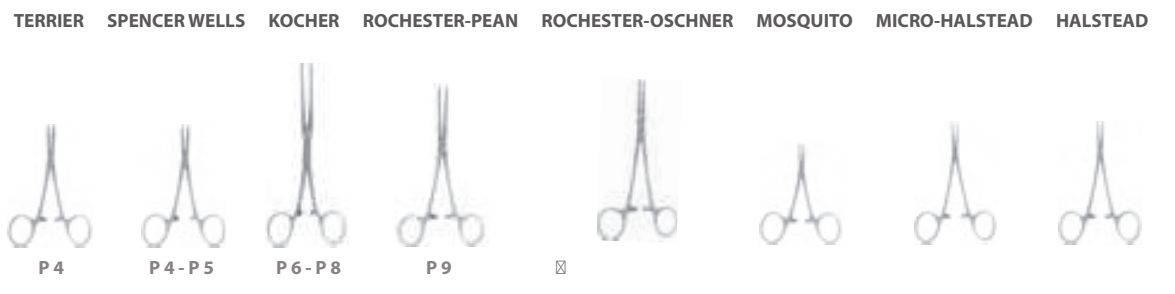

Pincès hémostatiques longues - Long haemostatic forceps - Pinzas hemostáticas largas



Pincès hémostatiques spéciales - Special haemostatic forceps - Pinzas hemostáticas especiales



Pincers diverses - Miscellaneous forceps - Pinzas diversas

OMBREDANE PEET PAUCHET

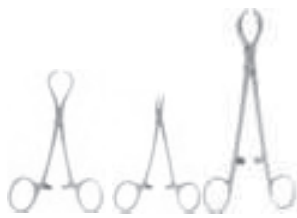

P 33 P 33 P 34

Pincers clamps - Clamp forceps - Pinzas clamps

STILLE GUYON MICHON LEGUEU GOULLOUD TOUPET  
MAYO-GUYON

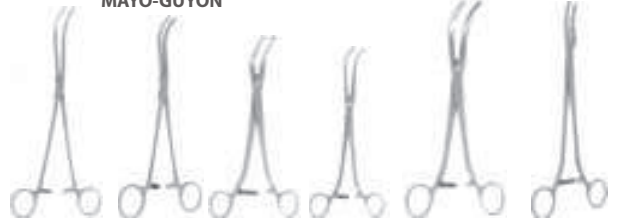

P 35 P 36 P 37 P 37 P 38 P 38

Pincers passe-fil Dissecteurs - Ligature forceps Dissectors - Pinzas pasa hilo Disecadores

REDON BABY-ADSON O'SHAUGNESSY ALLAINE OVERHOLT-GEISSENDORFER OVERHOLT-SLIM SCHNIDT QUILICY FARISSE  
OVERHOLT-S



P 40 P 40 P 41 - P 45 P 45 P 45 P 45 P 45 P 45 P 45

JACOBSON-ADSON KANTROWITZ RUMEL MEEKER SEMB SEMB-TAYLOR BARRAYA FINOCHIETTO HARRINGTON RESANO



P 48 P 49 P 51 P 51 P 51 P 51 P 51 P 51 P 51 P 51

Pincers clamps intestinales et stomacales - Intestinal and stomach clamp forceps - Pinzas clamp intestinales y estomacales

QUENU HARTMANN DOYEN NEGUS BABY DOYEN MAYO ROBSON SCHEIBE DOYEN KOCHER PAYR



P 56 P 56 P 56 P 56 P 56 P 56 P 59 P 59 P 60 P 61

Pincers à préhension - Grasping forceps - Pinzas a presión

PRICE THOMAS DE MARTEL WALTER-DUVAL DUVAL PENNINGTON COLLIN LOVELACE AUVERT GREGOIRE CHAPUT

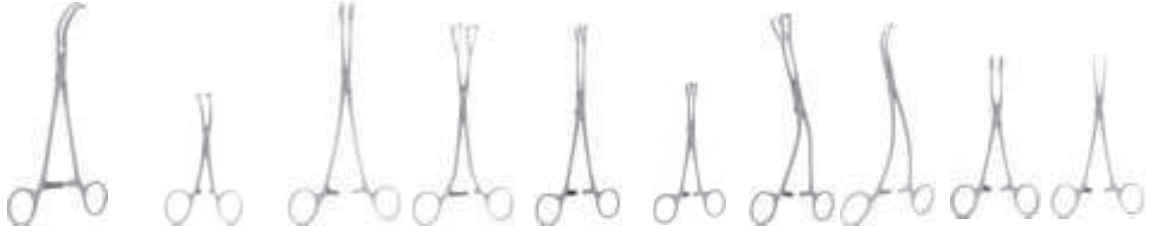

P 62 P 63 P 65 P 67 - P 67 P 67 - P 67 P 67 - P 67 P 67 - P 67 P 67 - P 67 P 67 - P 67 P 67 - P 67

Pinces à préhension - Grasping forceps - Pinzas a prensión

CHAPUT-MAYO ALLIS BABY-ALLIS JUDD-ALLIS TUFFIER LIEGE BABCOCK PRATT BENSON

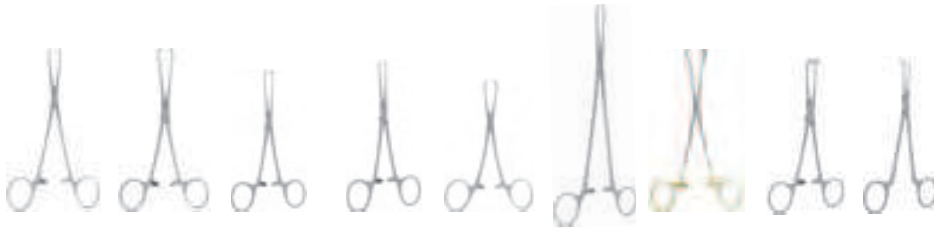

P 72 P 73 P 74 ☒

Pinces à champs - Towel forceps - Pinzas de compo

DOYEN SCHADEL JONES BACKHAUS PEERS TOHOKU LORNA

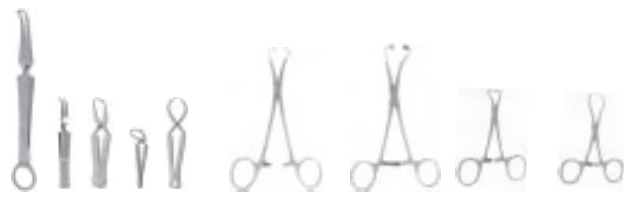

P 78 P 78 P 78 P 79 - P 80 P 80 P 81 P 81

Pinces diverses - Miscellaneous forceps - Pinzas diversas

**Pour drains**  
For drainage-tube  
Para las canulas  
GUNNAR-HEY LOCHARD WEISS HOFFMAN MOHR MURPHY

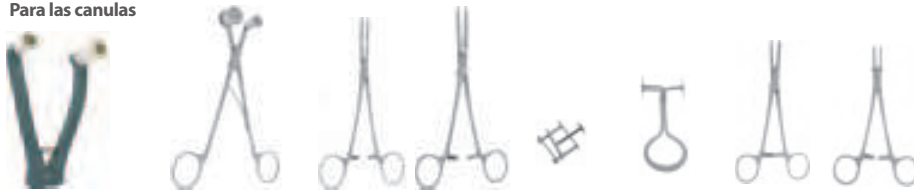

P 82 ☒ P 85

Pinces Prestige hémostatiques - Prestige Haemostatic forceps - Pinzas hemostáticas Prestige

HALSTEAD LERICHE BENGOLEA KOCHER KELLY CRILE CHRISTOPHE

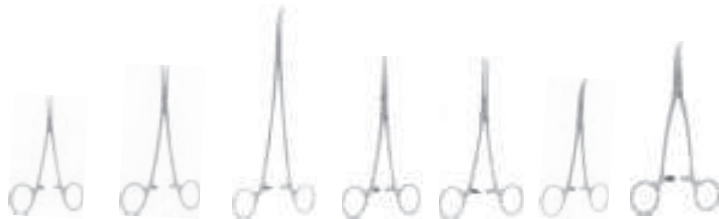

P 86 ☒

Pour pansements - For dressing - Para vendajes

CHERON FOERSTER BOZEMAN

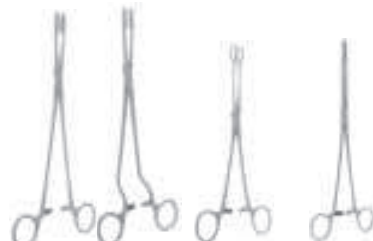

P 1 P 1 P 2 - P 3 P 3

Pinces utérines - Uterines forceps - Pinzas uterinas

MUSEUX MUSEUX PALMER MATHIEU Polypes - Polypus Polipos PALMER POZZI PALMER



P 4-☒

VIII - Voies basses  
VIII - Gyne/Uro/Procto  
VIII - Gyne/Uro/Procto

IV - Pinces  
IV - Forceps  
IV - Pinzas

IV - Pinces  
IV - Forceps  
IV - Pinzas

VIII - Voies basses  
VIII - Gyne/Uro/Procto  
VIII - Gyne/Uro/Procto

Pinces utérines - Uterines forceps - Pinzas uterinas

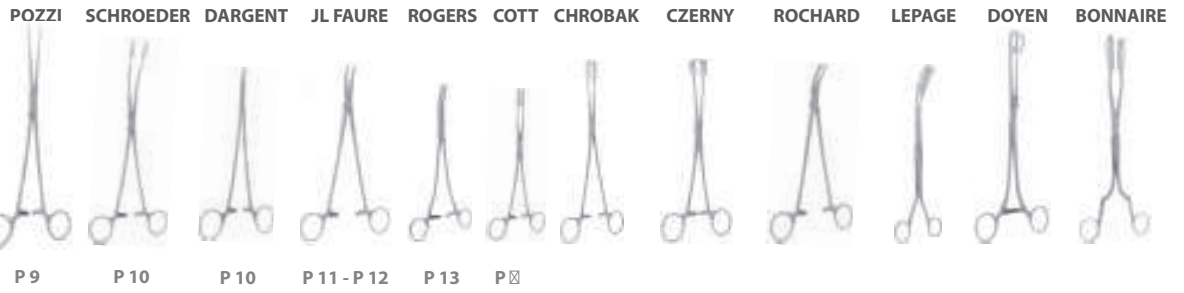

IX - Voies biliaires  
IX - Bile ducts  
IX - Vias biliaires

Instruments pour voies biliaires - Instruments for bile ducts - Instrumental para vías biliaires

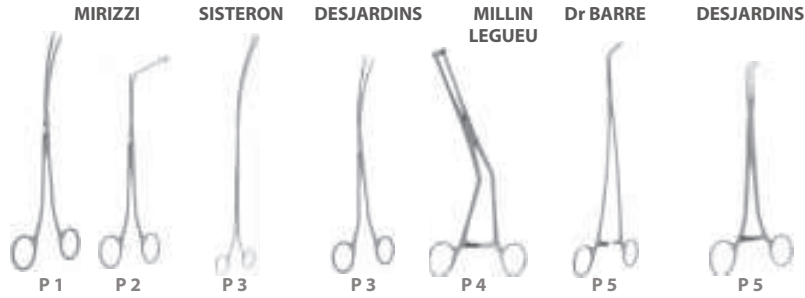

XII - O.R.L.  
XII - E.N.T.  
XII - O.R.L.

O.R.L. pinces à préhension - E.N.T. grasping forceps - O.R.L. pinzas a prensión

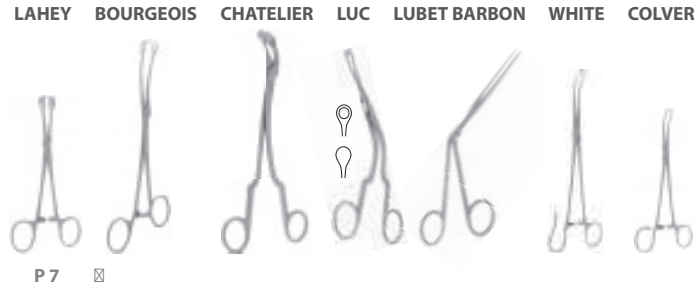

XIII - Osseux  
XIII - Bones surgery  
XIII - Cirugia osea

Pour ménisque - For meniscus - Para menisco

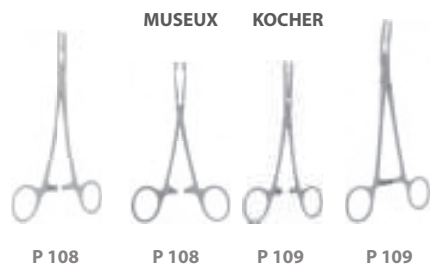

XV - Divers  
XV - Miscellaneous  
XV - Diversos

Service - Services - Servicio

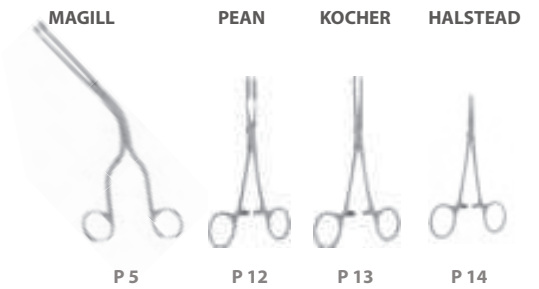

XV - Divers  
XV - Miscellaneous  
XV - Diversos

Service - Services - Servicio

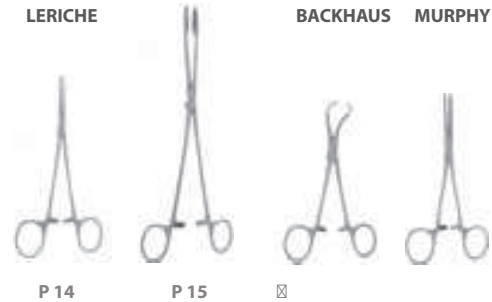

Pour plâtre - For plaster - Para escayolas

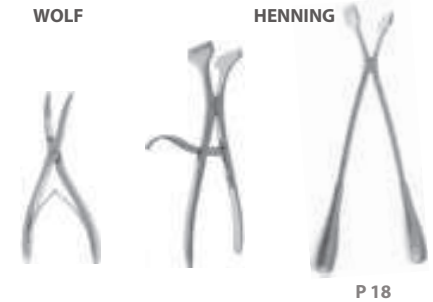

# LANDANGER

Pinces à pansements - Bandage forceps - Pinzas para vendajes



## PEAN

12 cm - 4 <sup>3</sup>/<sub>4</sub> " **B50010**

14 cm - 5 <sup>1</sup>/<sub>2</sub> " **B50020**

16 cm - 6 <sup>1</sup>/<sub>4</sub> " **B50025**

14 cm - 5 <sup>1</sup>/<sub>2</sub> " **B50050**

16 cm - 6 <sup>1</sup>/<sub>4</sub> " **B50055**



A doigt  
Collin's lock  
Desmontable

**B50010**  
12 cm - 4 <sup>3</sup>/<sub>4</sub> "



**B50055**  
16 cm - 6 <sup>1</sup>/<sub>4</sub> "

IV - Pinces  
IV - Forceps  
IV - Pinzas

**IV - 1**

# LANDANGER

Pinces à pansements - Bandage forceps - Pinzas para vendajes

1/1

IV - Pinces  
IV - Forceps  
IV - Pinzas

Modèle Landanger  
Landanger model  
Modelo Landanger



**B50793**  
16 cm - 6 <sup>1</sup>/<sub>4</sub> "



**B50794**  
24 cm - 9 <sup>1</sup>/<sub>2</sub> "

IV - 2

# LANDANGER

Pinces à pansements - Bandage forceps - Pinzas para vendajes

## GROSS MAYER

1/1

Droite	Courbe
Straight	Curve
Recta	Curva

20 cm - 8"

**B507701**

**B507702**

25 cm - 10"

**B50780**

**B50785**



**B50780**  
25 cm - 10 "

D'autres modèles dans le CHAPITRE VOIES BASSES  
Others models in the GYNE/URO/PROCTO CHAPTER  
Otros modelos en el CAPÍTULO GYNE/URO/PROCTO

IV - Pinces  
IV - Forceps  
IV - Pinzas

# LANDANGER

Pinces hémostatiques - Haemostatic forceps - Pinzas hemostaticas



**TERRIER**

**SPENCER WELLS**

IV - Pinces  
IV - Forceps  
IV - Pinzas



**B50455**  
12 cm - 4 <sup>3</sup>/<sub>4</sub> "



**B50465**  
12 cm - 4 <sup>3</sup>/<sub>4</sub> "

**IV - 4**



## SPENCER WELLS

	Droite Straight Recta	Courbe Curved Curva
13 cm - 5 "	<b>B504651</b>	<b>B504661</b>
15 cm - 6 "	<b>B504652</b>	<b>B504662</b>
18 cm - 7 "	<b>B504653</b>	<b>B504663</b>

Modèle allemand  
German model  
Modelo alemán



**B504651**  
13 cm - 5 "

# LANDANGER

Pinces hémostatiques - Haemostatic forceps - Pinzas hemostaticas

1/1

## KOCHER

Droite  
Straight  
Recta

13 cm - 5 "

**B50070**

15 cm - 6 "

**B50075**

18 cm - 7 "

**B50085**

IV - Pinces  
IV - Forceps  
IV - Pinzas



A doigt  
Collin's lock  
Desmontable

**B50075**  
15 cm - 6 "

**B50085**  
18 cm - 7 "

**IV - 6**

# LANDANGER

## Pinces hémostatiques - Haemostatic forceps - Pinzas hemostaticas

### KOCHER



A griffes    Sans griffes  
With teeth   Without teeth  
Con dientes   Sin dientes

14 cm - 5 1/2"	<b>B50200</b>	<b>B50202</b>
15 cm - 6"	<b>B50205</b>	<b>B50207</b>
16 cm - 6 1/4"	<b>B50210</b>	<b>B50212</b>
18 cm - 7"	<b>B50215</b>	<b>B50217</b>
21 cm - 8 1/4"	<b>B50220</b>	<b>B50225</b>
24 cm - 9 1/2"	<b>B50230</b>	<b>B50231</b>

Mors courts  
Short jaws  
Boca corta

15 cm - 6"	<b>B50272</b>	<b>B50274</b>
------------	---------------	---------------

Droite  
Straight  
Recta



**B50202**  
14 cm - 5 1/2"



**B50274**  
15 cm - 6"  
Mors courts - Short jaws - Boca corta



**B50207**  
15 cm - 6"



**B50212**  
16 cm - 6 1/4"



**B50217**  
18 cm - 7"



**B50225**  
21 cm - 8 1/4"



**B50231**  
24 cm - 9 1/2"



Sans griffes  
Without teeth  
Sin dientes

**B50202**  
14 cm - 5 1/2"

IV - Pinces  
IV - Forceps  
IV - Pinzas

# LANDANGER

## Pinces hémostatiques - Haemostatic forceps - Pinzas hemostaticas



### KOCHER

A griffes    Sans griffes  
With teeth   Without teeth  
Con dientes   Sin dientes

Courbe  
Curved  
Curva

14 cm - 5 1/2"	<b>B50235</b>	<b>B50236</b>
15 cm - 6"	<b>B50240</b>	<b>B50242</b>
16 cm - 6 1/4"	<b>B50245</b>	<b>B50247</b>
18 cm - 7"	<b>B50250</b>	<b>B50252</b>
21 cm - 8 1/4"	<b>B50255</b>	<b>B50257</b>
24 cm - 9 1/2"	<b>B50265</b>	<b>B50267</b>

Mors courts  
Short jaws  
Boca corta  
15 cm - 7"

<b>B50276</b>	<b>B50278</b>
---------------	---------------



**B50236**

14 cm - 5 1/2"

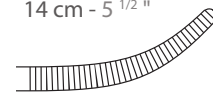

**B50278**

15 cm - 6"

Mors courts - Short jaws - Boca corta

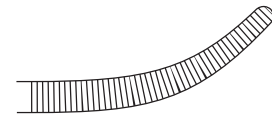

**B50242**

15 cm - 6"

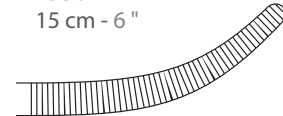

**B50247**

16 cm - 6 1/4"

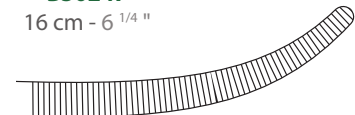

**B50252**

18 cm - 7"

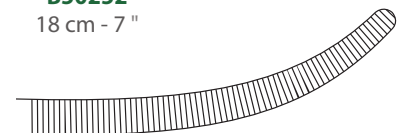

**B50257**

21 cm - 8 1/4"

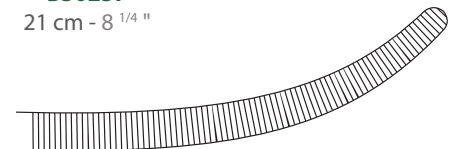

**B50267**

24 cm - 9 1/2"



Sans griffes  
Without teeth  
Sin dientes

**B50236**

14 cm - 5 1/2"

# LANDANGER

Pinces hémostatiques - Haemostatic forceps - Pinzas hemostaticas

## ROCHESTER-PEAN



Droite  
Straight  
Recta

Courbe  
Curved  
Curva

Sans griffes  
Without teeth  
Sin dientes

16 cm - 6 1/4 "	<b>B50700</b>	<b>B50710</b>
18 cm - 7 "	<b>B50705</b>	<b>B50715</b>
20 cm - 8 "	<b>B50706</b>	<b>B50720</b>
22 cm - 8 3/4 "	<b>B507065</b>	<b>B507210</b>
24 cm - 9 1/2 "	<b>B50707</b>	<b>B50725</b>
26 cm - 10 1/4 "	<b>B507080</b>	<b>B507261</b>
30 cm - 11 3/4 "	<b>B507081</b>	<b>B507262</b>



**B50700**  
16 cm - 6 1/4 "



**B50700**  
16 cm - 6 1/4 "



**B50705**  
18 cm - 7 "



**B50706**  
20 cm - 7 3/4 "



**B50707**  
24 cm - 9 1/2 "

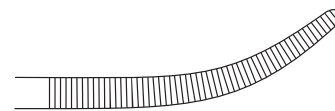

**B50710**  
16 cm - 6 1/4 "



**B50715**  
18 cm - 7 "

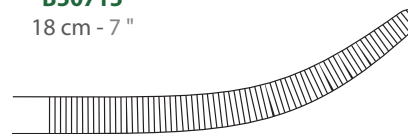

**B50720**  
20 cm - 7 3/4 "

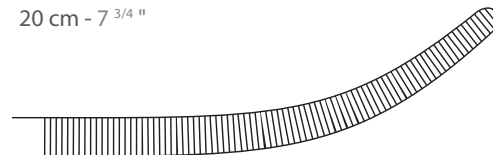

**B50725**  
24 cm - 9 1/2 "

IV - Pinces  
IV - Forceps  
IV - Pinzas

# LANDANGER

Pinces hémostatiques - Haemostatic forceps - Pinzas hemostaticas



## ROCHESTER-OSCHNER

Droite	Courbe
Straight	Curved
Recta	Curva

16 cm - 6 1/4 "	<b>B50730</b>	<b>B50740</b>
18 cm - 7 "	<b>B50735</b>	<b>B50745</b>

A griffes  
With teeth  
Con dientes



**B50730**  
16 cm - 6 1/4 "



**B50735**  
18 cm - 7 "



**B50740**  
16 cm - 6 1/4 "

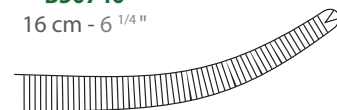

**B50745**  
18 cm - 7 "



**B50730**  
16 Cm 6 1/4 "

IV - 10

IV - Pinces  
IV - Forceps  
IV - Pinzas

## MOSQUITO

Modèle français  
French model  
Modelo francés

A griffes    Sans griffes  
With teeth   Without teeth  
Con dientes   Sin dientes

10 cm - 4 "

**B50430**

**B50435**

A griffes    Sans griffes  
With teeth   Without teeth  
Con dientes   Sin dientes

10 cm - 4 "

**B50440**

**B50445**

Droite  
Straight  
Recta



**B50435**  
10 cm - 4 "

Courbe  
Curved  
Curva



**B50445**  
10 cm - 4 "

# LANDANGER

## Pinces hémostatiques - Haemostatic forceps - Pinzas hemostaticas



### MICRO-HALSTEAD

### HALSTEAD

Modèle français  
French model  
Modelo francés

Droite  
Straight  
Recta  
12 cm - 4 <sup>3</sup>/<sub>4</sub>"

A griffes With teeth Con dientes	Sans griffes Without teeth Sin dientes
<b>B50446</b>	<b>B50447</b>

Courbe  
Curved  
Curva  
12 cm - 4 <sup>3</sup>/<sub>4</sub>"

<b>B50448</b>	<b>B50449</b>
---------------	---------------

Droite  
Straight  
Recta  
12 cm - 4 <sup>3</sup>/<sub>4</sub>"

A griffes With teeth Con dientes	Sans griffes Without teeth Sin dientes
<b>B50410</b>	<b>B50415</b>

Courbe  
Curved  
Curva  
12 cm - 4 <sup>3</sup>/<sub>4</sub>"

<b>B50420</b>	<b>B50425</b>
---------------	---------------

IV - Pinces  
IV - Forceps  
IV - Pinzas

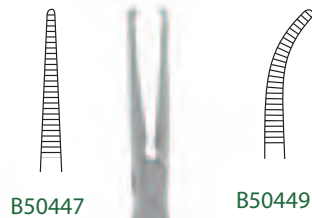

B50447

B50449

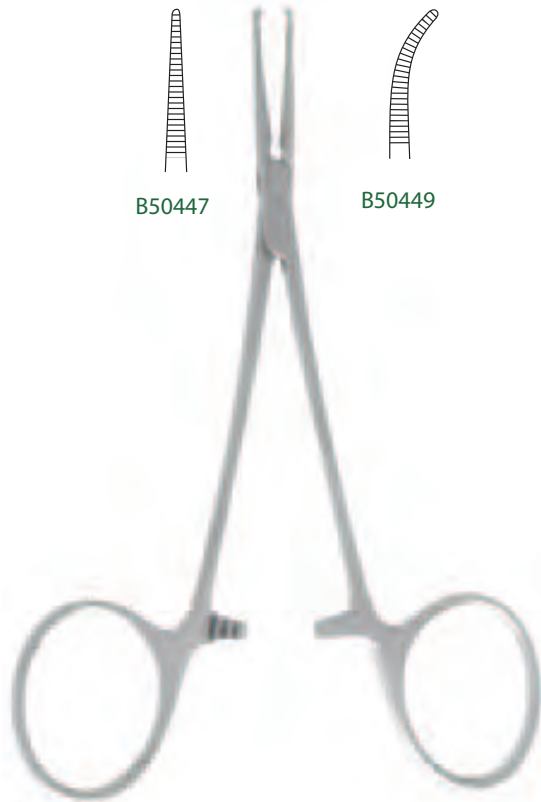

**B50446**  
12 cm - 4 <sup>3</sup>/<sub>4</sub>"

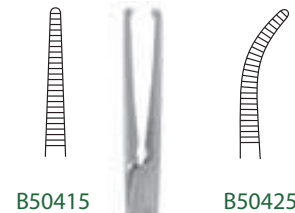

B50415

B50425



**B50410**  
12 cm - 4 <sup>3</sup>/<sub>4</sub>"



## MICRO-MOSQUITO

Modèle allemand  
German model  
Modelo alemán

A griffes    Sans griffes  
With teeth    Without teeth  
Con dientes    Sin dientes

A griffes    Sans griffes  
With teeth    Without teeth  
Con dientes    Sin dientes

10 cm - 4"    **B504592**    **B504590**  
12 cm - 4 3/4"    **B504593**    **B504591**

10 cm - 4"    **B504596**    **B504594**  
12 cm - 4 3/4"    **B504597**    **B504595**

Droite  
Straight  
Recta

Courbe  
Curved  
Curva

IV - Pinces  
IV - Forceps  
IV - Pinzas



# LANDANGER

## Pinces hémostatiques - Haemostatic forceps - Pinzas hemostaticas



### HALSTEAD-MOSQUITO

Modèle allemand  
German model  
Modelo alemán

	A griffes With teeth Con dientes	Sans griffes Without teeth Sin dientes		A griffes With teeth Con dientes	Sans griffes Without teeth Sin dientes
12 cm - 4 3/4 "	<b>B504582</b>	<b>B504580</b>	12 cm - 4 3/4 "	<b>B504586</b>	<b>B504584</b>
14 cm - 5 1/2 "	<b>B504583</b>	<b>B504581</b>	14 cm - 5 1/2 "	<b>B504587</b>	<b>B504585</b>
18 cm - 7 "	<b>B504564</b>	<b>B504560</b>	18 cm - 7 "	<b>B504566</b>	<b>B504562</b>
21 cm - 8 1/4 "	<b>B504565</b>	<b>B504561</b>	21 cm - 8 1/4 "	<b>B504567</b>	<b>B504563</b>

IV - Pinces  
IV - Forceps  
IV - Pinzas

Droite  
Straight  
Recta

Courbe  
Curved  
Curva

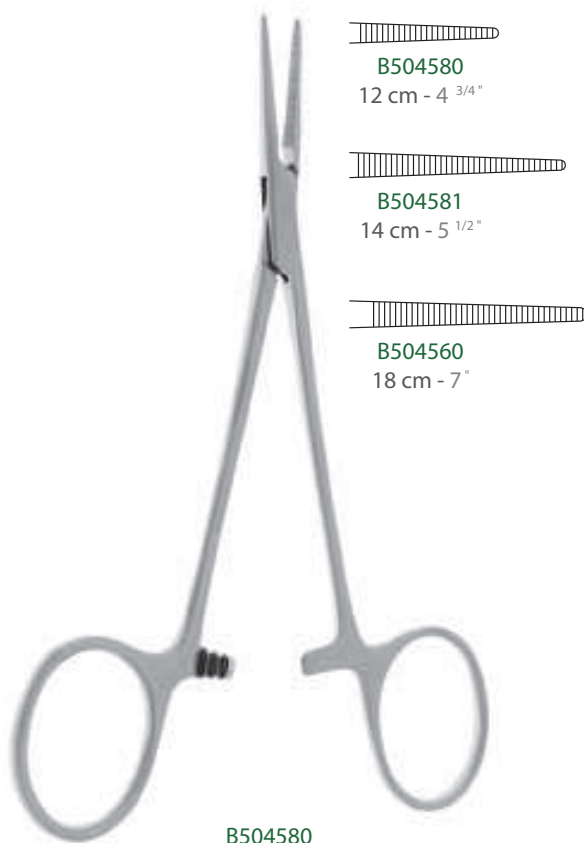

**IV - 14**

## BONNIOT

A griffes    Sans griffes  
With teeth   Without teeth  
Con dientes   Sin dientes

15 cm - 6"

**B503001**

**B503000**

A griffes    Sans griffes  
With teeth   Without teeth  
Con dientes   Sin dientes

15 cm - 6"

**B503011**

**B503010**

Droite  
Straight  
Recta

Courbe  
Curved  
Curva



**B503000**  
15 cm - 6"



**B503010**  
15 cm - 6"

IV - Pinces  
IV - Forceps  
IV - Pinzas

# LANDANGER

## Pinces hémostatiques - Haemostatic forceps - Pinzas hemostaticas



### LERICHE

	A griffes With teeth Con dientes	Sans griffes Without teeth Sin dientes		A griffes With teeth Con dientes	Sans griffes Without teeth Sin dientes
15 cm - 6 "	<b>B50330</b>	<b>B50345</b>	15 cm - 6 "	<b>B50360</b>	<b>B50375</b>
18 cm - 7 "	<b>B50335</b>	<b>B50350</b>	18 cm - 7 "	<b>B50365</b>	<b>B50380</b>
21 cm - 8 1/4 "	<b>B50340</b>	<b>B50355</b>	21 cm - 8 1/4 "	<b>B50370</b>	<b>B50385</b>

Droite  
Straight  
Recta

Courbe  
Curved  
Curva



**B50330**  
15 cm 6 "

**B50360**  
15 cm 6 "

IV - Pinces  
IV - Forceps  
IV - Pinzas

# LANDANGER

## Pinces hémostatiques - Haemostatic forceps - Pinzas hemostaticas



### PROVIDENCE

Droite  
Straight  
Recta

Courbe  
Curved  
Curva

14 cm - 5 1/2 "

**B508400**

**B508401**

### DANDY

A griffes  
With teeth  
Con dientes

Sans griffes  
Without teeth  
Sin dientes

14 cm - 5 1/2 "

**B508451**

**B508450**

### MOSQUITO-DANDY

12 cm - 4 3/4 "

-

**B508455**

Sans griffes  
Without teeth  
Sin dientes

Courbe  
Curved  
Curva



**B508401**  
14 cm - 5 1/2 "



**B508451**  
14 cm - 5 1/2 "

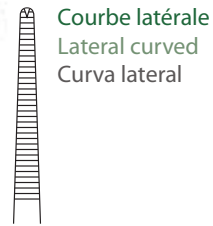

Courbe latérale  
Lateral curved  
Curva lateral

IV - Pinces  
IV - Forceps  
IV - Pinzas

# LANDANGER

## Pinces hémostatiques - Haemostatic forceps - Pinzas hemostaticas



### DIXON-LOVELACE

A griffes    Sans griffes  
With teeth   Without teeth  
Con dientes   Sin dientes

16 cm - 6 1/4"

**B50282**

**B50284**

A griffes    Sans griffes  
With teeth   Without teeth  
Con dientes   Sin dientes

16 cm - 6 1/4"

**B50286**

**B50288**

Droite  
Straight  
Recta

Courbe  
Curved  
Curva

IV - Pinces  
IV - Forceps  
IV - Pinzas

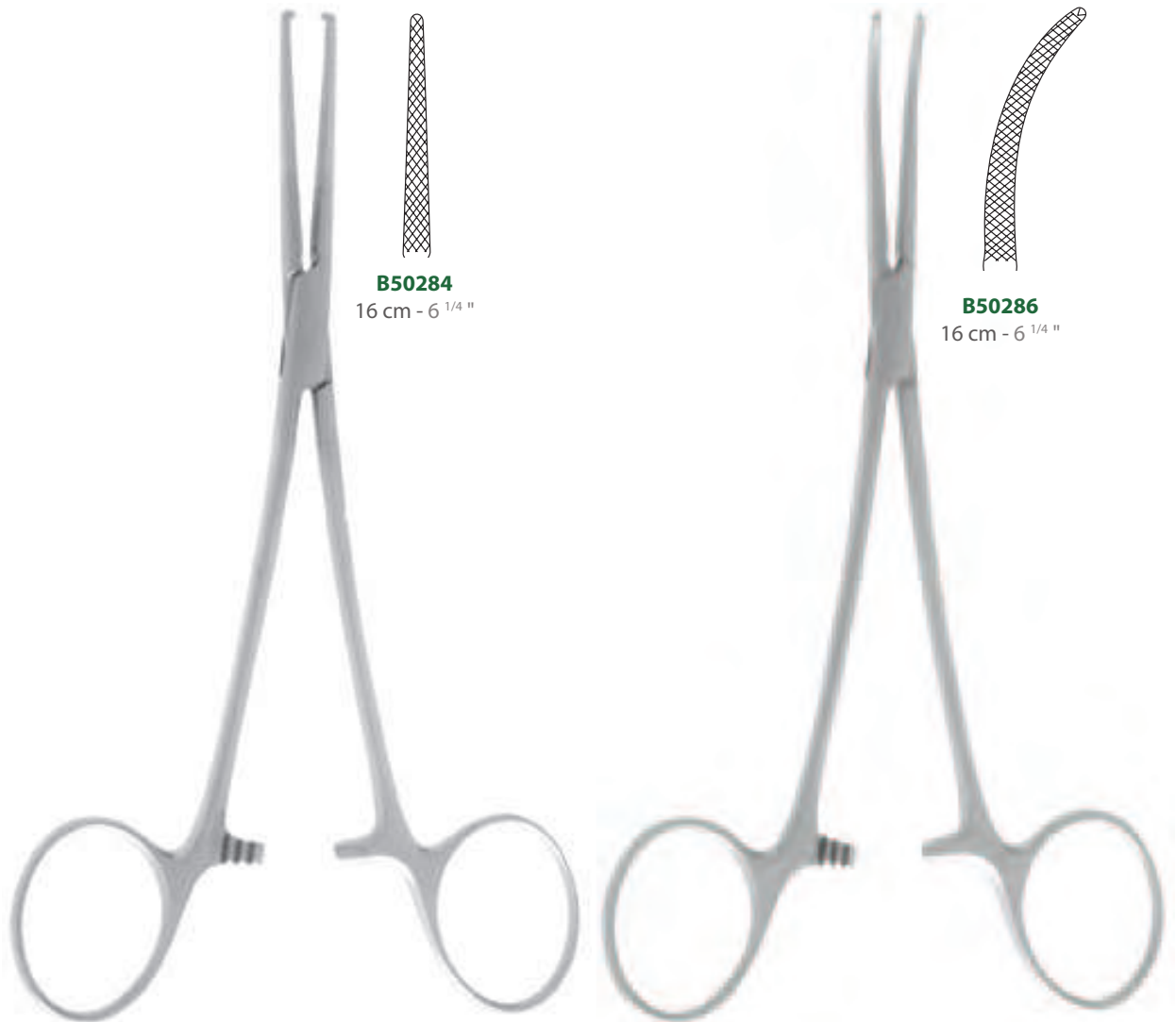

**B50284**  
16 cm - 6 1/4 "

**B50286**  
16 cm - 6 1/4 "

**B50282**  
16 cm - 6 1/4 "

**B50288**  
16 cm - 6 1/4 "

**IV - 18**

# LANDANGER

## Pinces hémostatiques - Haemostatic forceps - Pinzas hemostaticas



### CRILE

A griffes    Sans griffes  
With teeth   Without teeth  
Con dientes   Sin dientes

A griffes    Sans griffes  
With teeth   Without teeth  
Con dientes   Sin dientes

14 cm - 5 1/2"	<b>B50660</b>	<b>B50680</b>
16 cm - 6 1/4"	<b>B50665</b>	<b>B50685</b>

14 cm - 5 1/2"	<b>B50670</b>	<b>B50690</b>
16 cm - 6 1/4"	<b>B50675</b>	<b>B50695</b>

Droite  
Straight  
Recta

Courbe  
Curved  
Curva



**B50660**  
14 cm - 5 1/2 "

**B50690**  
14 cm - 5 1/2 "

IV - Pinces  
IV - Forceps  
IV - Pinzas

# LANDANGER

## Pinces hémostatiques - Haemostatic forceps - Pinzas hemostaticas



### KELLY

A griffes    Sans griffes  
With teeth   Without teeth  
Con dientes   Sin dientes

A griffes    Sans griffes  
With teeth   Without teeth  
Con dientes   Sin dientes

14 cm - 5 1/2"

**B50555**

**B50575**

14 cm - 5 1/2"

**B50595**

**B50615**

16 cm - 6 1/4"

**B50560**

**B50580**

16 cm - 6 1/4"

**B50600**

**B50620**

18 cm - 7"

**B50565**

**B50585**

18 cm - 7"

**B50605**

**B50625**

21 cm - 8 1/4"

**B50570**

**B50590**

21 cm - 8 1/4"

**B50610**

**B50630**

Droite  
Straight  
Recta

Courbe  
Curved  
Curva



**B50575**

14 cm - 5 1/2"



**B50615**

14 cm - 5 1/2"



**B50580**

16 cm - 6 1/4"

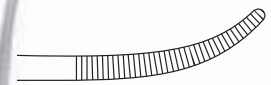

**B50620**

16 cm - 6 1/4"



**B50585**

18 cm - 7"



**B50625**

18 cm - 7"



**B50590**

21 cm - 8 1/4"



**B50630**

21 cm - 8 1/4"

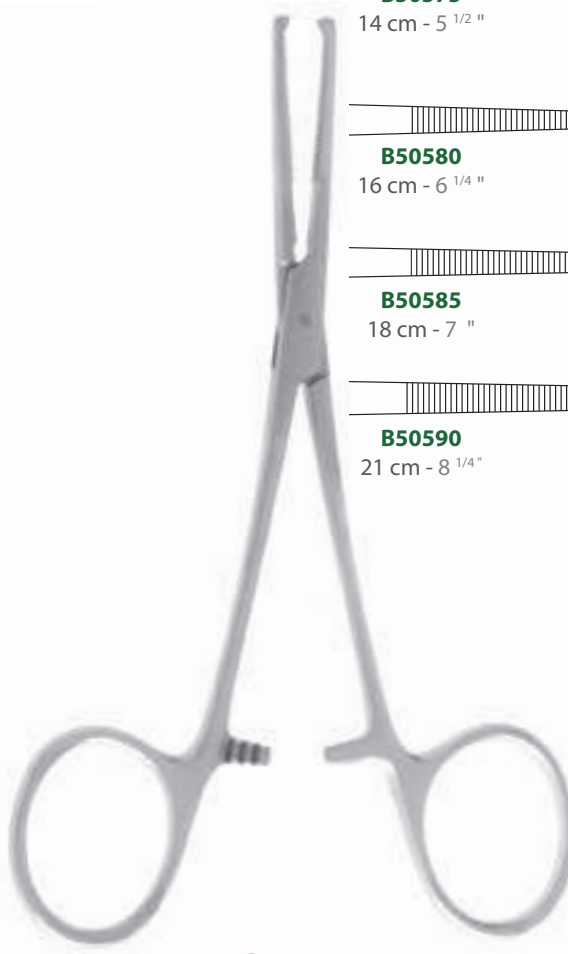

**B50555**

14 cm - 5 1/2"

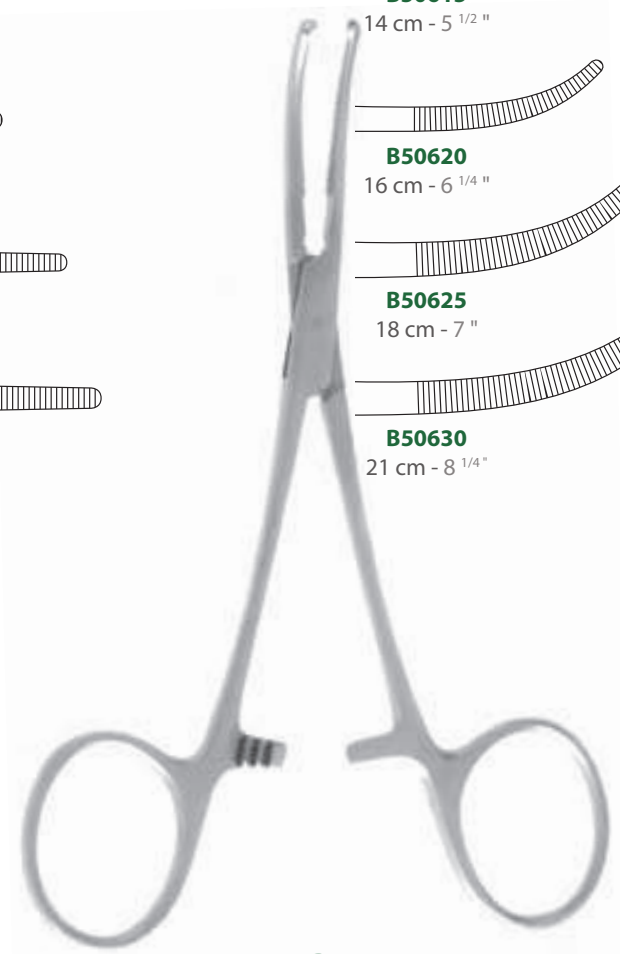

**B50595**

14 cm 5 1/2"



KELLY-RANKIN

Droite  
Straight  
Recta

Courbe  
Curve  
Curva



**B50632**  
16 cm 6 1/4 "

**B50634**  
16 cm 6 1/4 "

IV - Pinces  
IV - Forceps  
IV - Pinzas

# LANDANGER

## Pinces hémostatiques - Haemostatic forceps - Pinzas hemostaticas



### CHRISTOPHE

A griffes    Sans griffes  
With teeth   Without teeth  
Con dientes Sin dientes

16 cm - 6 1/4"

**B50750**

**B50755**

A griffes    Sans griffes  
With teeth   Without teeth  
Con dientes Sin dientes

16 cm - 6 1/4"

**B50760**

**B50765**

Droite  
Straight  
Recta

Courbe  
Curved  
Curva

IV - Pinces  
IV - Forceps  
IV - Pinzas



**IV - 22**

**B50750**  
16 cm - 6 1/4"

**B50765**  
16 cm - 6 1/4"

# LANDANGER

## Pinces hémostatiques longues - Long haemostatic forceps - Pinzas hemostaticas largas

### HEISS



A griffes    Sans griffes  
With teeth    Without teeth  
Con dientes    Sin dientes

A griffes    Sans griffes  
With teeth    Without teeth  
Con dientes    Sin dientes

20 cm - 8 "

**B60450**

**B60460**

20 cm - 8 "

**B60470**

**B60480**

Droite  
Straight  
Recta

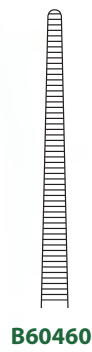

**B60460**

Courbe  
Curved  
Curva

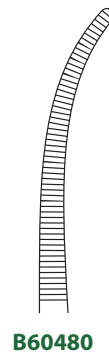

**B60480**



**B60460**  
20 cm 8 "

**B60480**  
20 cm 8 "

IV - Pinces  
IV - Forceps  
IV - Pinzas

# LANDANGER

## Pinces hémostatiques longues - Long haemostatic forceps - Pinzas hemostaticas largas



### BENGOLEA

	A griffes With teeth Con dientes	Sans griffes Without teeth Sin dientes		A griffes With teeth Con dientes	Sans griffes Without teeth Sin dientes
21 cm - 8 1/4 "	<b>B60140</b>	<b>B60180</b>	21 cm - 8 1/4 "	<b>B60220</b>	<b>B60260</b>
24 cm - 9 1/2 "	<b>B60150</b>	<b>B60190</b>	24 cm - 9 1/2 "	<b>B60230</b>	<b>B60270</b>
30 cm - 11 3/4 "	<b>B60160</b>	<b>B60200</b>	30 cm - 11 3/4 "	<b>B60240</b>	<b>B60280</b>

Droite  
Straight  
Recta

Courbe  
Curved  
Curva

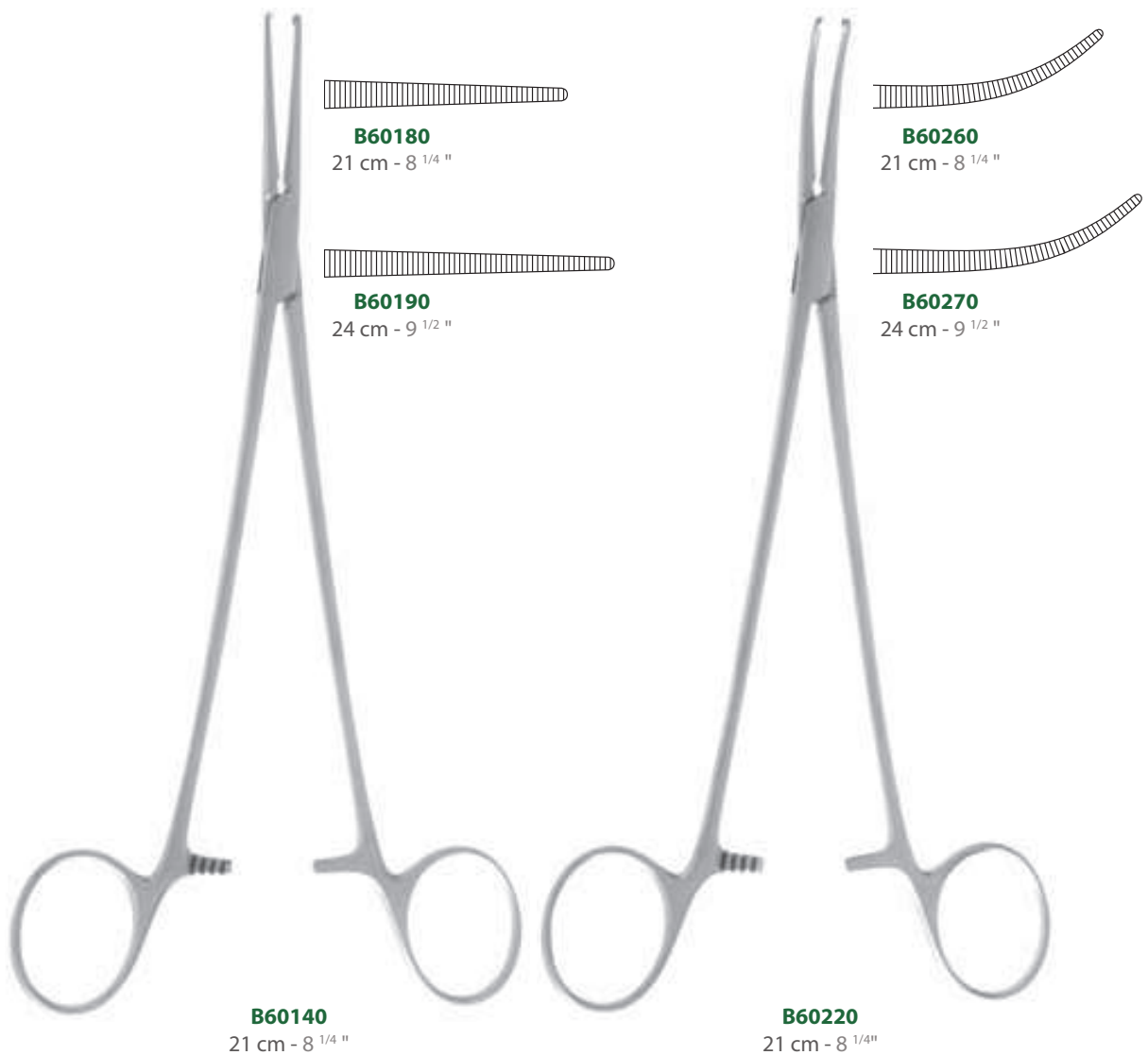

IV - Pinces  
IV - Forceps  
IV - Pinzas

IV - 24

## BENGOLEA

Modèle allemand  
German model  
Modelo alemán

	A griffes With teeth Con dientes	Sans griffes Without teeth Sin dientes		A griffes With teeth Con dientes	Sans griffes Without teeth Sin dientes
21 cm - 8 1/4 "	<b>B602908</b>	<b>B602900</b>		<b>B602912</b>	<b>B602904</b>
24 cm - 9 1/2 "	<b>B602910</b>	<b>B602902</b>		<b>B602914</b>	<b>B602906</b>

Droite  
Straight  
Recta



**B602900**  
21 cm - 8 1/4 "

Courbe  
Curved  
Curva

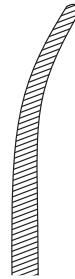

**B602904**  
21 cm - 8 1/4 "



**B602904**  
21 cm - 8 1/4 "

# LANDANGER

## Pinces hémostatiques longues - Long haemostatic forceps - Pinzas hemostaticas largas



### ROBERTS

### SAROT

Droite      Courbe  
Straight    Curved  
Recta       Curva

24 cm - 9 1/2"

**B609115**

**B609116**

IV - Pinces  
IV - Forceps  
IV - Pinzas



**B609110**  
22 cm - 8 3/4"

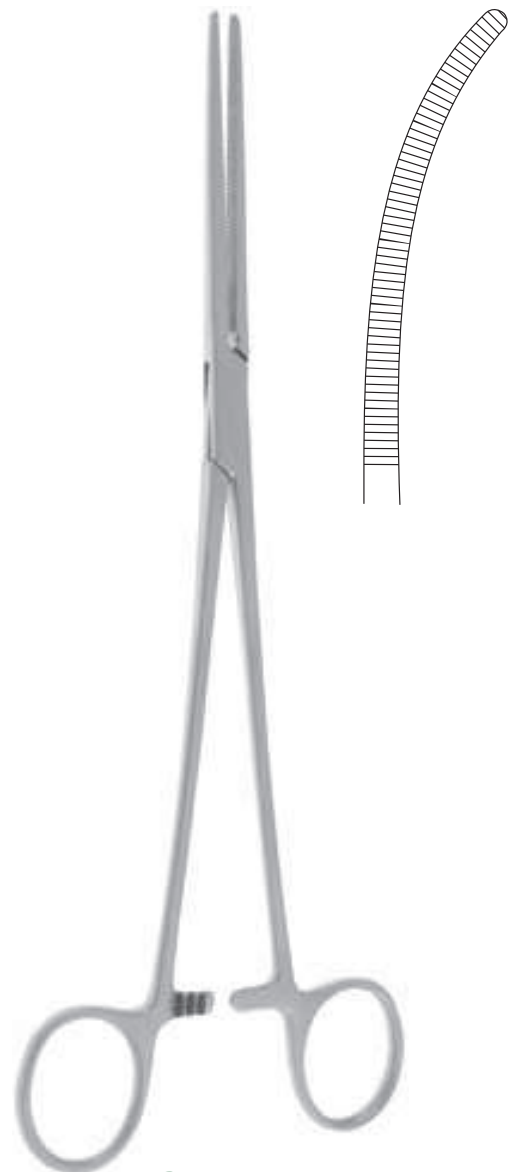

**B609115**  
24 cm - 9 1/2"

# LANDANGER

Pinces hémostatiques longues - Long haemostatic forceps - Pinzas hemostaticas largas

SANTY



Courbe  
Curved  
Curva

A griffes    Sans griffes  
With teeth    Without teeth  
Con dientes    Sin dientes

24 cm - 9 1/2 "

**B60330**

**B60340**

30 cm - 11 3/4 "

**B60350**

**B60360**

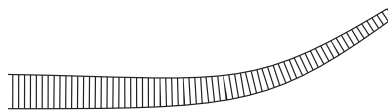

**B60340**

24 cm - 9 1/2 "



**B60360**

30 cm - 12 "

IV - Pinces  
IV - Forceps  
IV - Pinzas

# LANDANGER

Pinces hémostatiques longues - Long haemostatic forceps - Pinzas hemostaticas largas



MOYNIHAN



**B60440**  
24 cm - 9 1/2 "

IV - Pinces  
IV - Forceps  
IV - Pinzas

**IV - 28**



## BAINBRIDGE

	Droite Straight Recta	Courbe Curve Curva
15 cm - 6"	<b>B508000</b>	<b>B508002</b>
18 cm - 7"	<b>B508001</b>	<b>B508003</b>

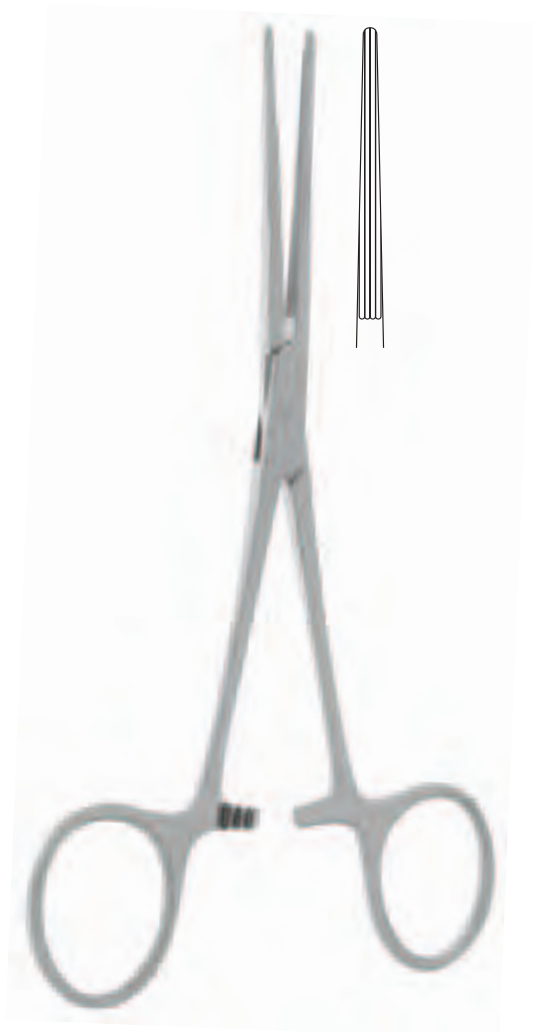

**B508000**  
15 cm - 6"

# LANDANGER

Pinces hémostatiques spéciales - Special haemostatic forceps - Pinzas hemostaticas especiales



## CRAFOORD (SELLORS)



Droite  
Straight  
Recta

**B60770**

24 cm - 9 1/2 "

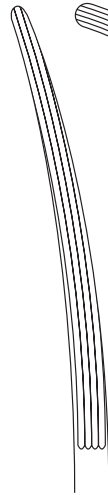

1/2 Courbe  
1/2 Curved  
1/2 Curva

**B60790**

24 cm - 9 1/2 "

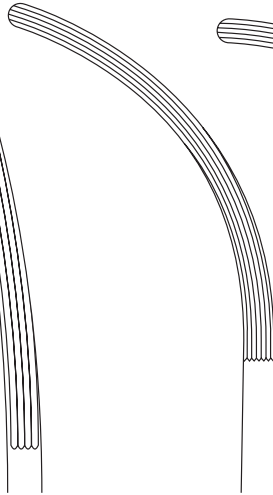

Courbe  
Curved  
Curva

**B607901**

23 cm - 9 "

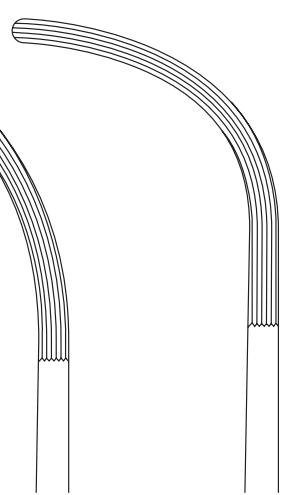

Très courbe  
Very curved  
Muy curva

**B607902**

22 cm - 8 3/4 "

**B60770**

24 cm - 9 1/2 "

**IV - 30**

IV - Pinces  
IV - Forceps  
IV - Pinzas

# LANDANGER

Pinces hémostatiques spéciales - Special haemostatic forceps - Pinzas hemostaticas especiales

## ROCHESTER-CARMALT



**B50746**  
16 cm - 6 1/4 "



**B50747**  
16 cm - 6 1/4 "



**B50748**  
20 cm - 8 "



**B50749**  
20 cm - 8 "



**B50746**  
16 cm - 6 1/4 "



**B50747**  
16 cm - 6 1/4 "

IV - Pinces  
IV - Forceps  
IV - Pinzas

# LANDANGER

## Pinces hémostatiques spéciales - Special haemostatic forceps - Pinzas hemostaticas especiales



Pinces pour le péritoine  
Peritoneal forceps  
Pinzas para peritoneo

**BABY-MIKULICZ**

**MIKULICZ**

Fine - Fine - Fina

18 cm - 7"

**B507662**

**B507661**

20 cm - 8"

-

**B50767**

IV - Pinces  
IV - Forceps  
IV - Pinzas

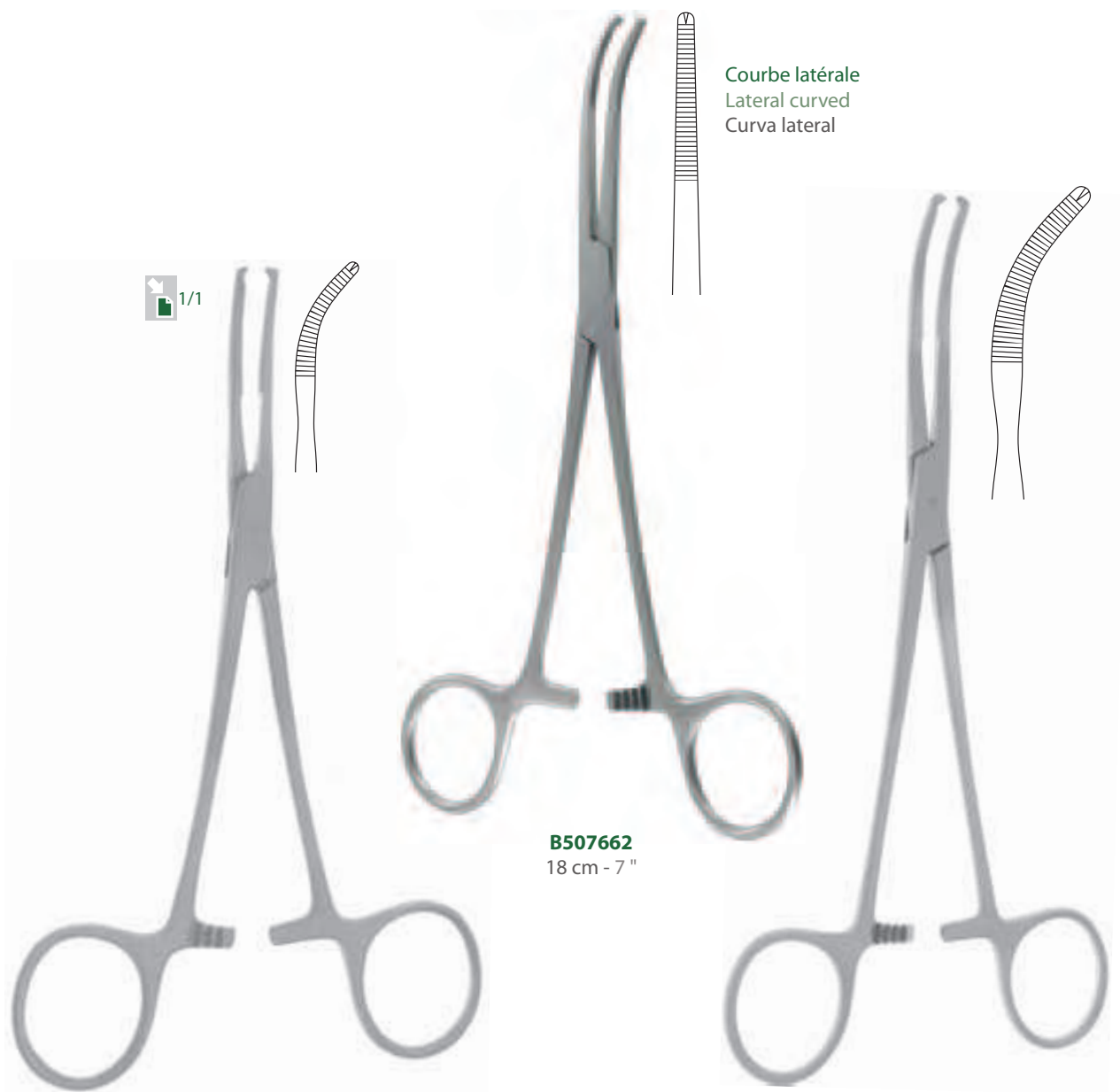

Courbe latérale  
Lateral curved  
Curva lateral

**B507662**  
18 cm - 7"

**B507660**  
14 cm - 5 1/2"

**B50767**  
20 cm - 8"

**IV - 32**

# LANDANGER

Pinces diverses - Miscellaneous forceps - Pinzas diversas



OMBREDANNE

PEET

Pince à échardes  
Splinter forceps  
Pinza para astillas



**B50805**  
14 cm - 5 1/2 "

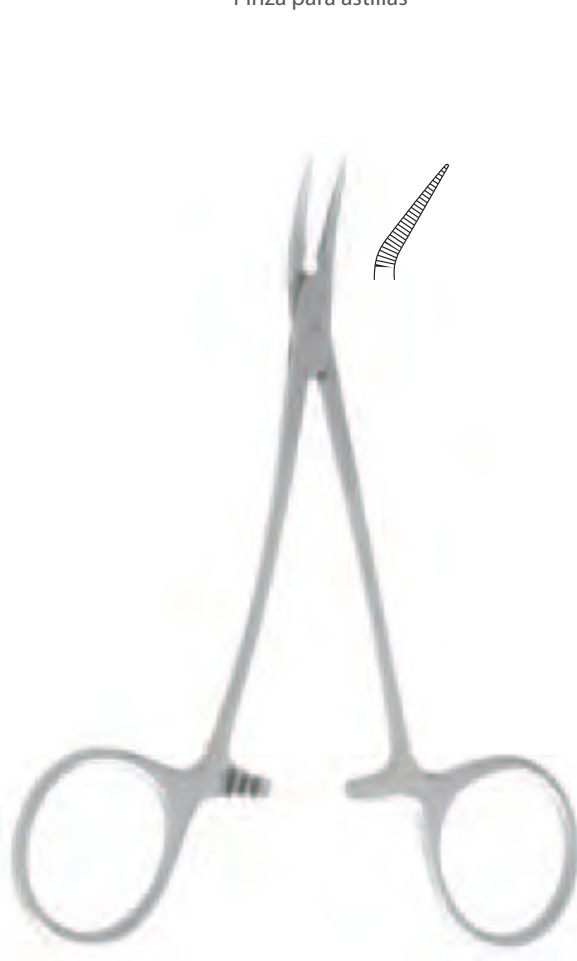

**B50830**  
12 cm - 4 3/4 "

IV - Pinces  
IV - Forceps  
IV - Pinzas

# LANDANGER

Pinces diverses - Miscellaneous forceps - Pinzas diversas



## PAUCHET



**B50810**  
20 cm - 8 "

IV - Pinces  
IV - Forceps  
IV - Pinzas

**IV - 34**

# LANDANGER

Pinces clamps - Clamp forceps - Pinzas clamps



STILLE



**B50835**  
24 cm - 9 1/2 "

IV - Pinces  
IV - Forceps  
IV - Pinzas

**IV - 35**

# LANDANGER

Pinces clamps - Clamp forceps - Pinzas clamps

## GUYON

## MAYO-GUYON

Mors non traumatisants  
Non-traumatic jaws  
Bocas no traumáticas

20 cm - 8"	<b>B554000</b>	-
22 cm - 8 3/4"	<b>B554005</b>	-
23 cm - 9"	<b>B554025</b>	<b>B554015</b>
24 cm - 9 1/2"	<b>B554010</b>	<b>B554020</b>

Pour pédicules rénaux  
For kidney pedicle  
Para pedúnculos renales

IV - Pinces  
IV - Forceps  
IV - Pinzas



**B554000**  
20 cm - 8"

**IV - 36**

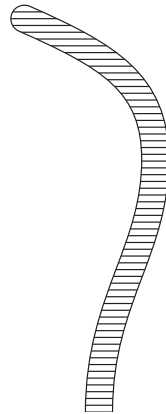

**B554000**

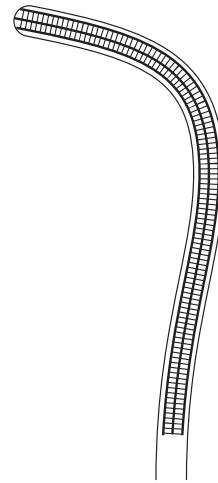

**B554015**

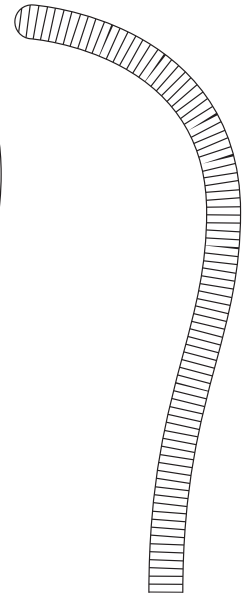

**B554030**  
23 cm - 9"

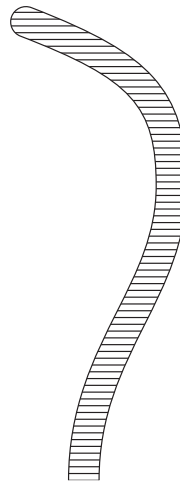

**B554005**

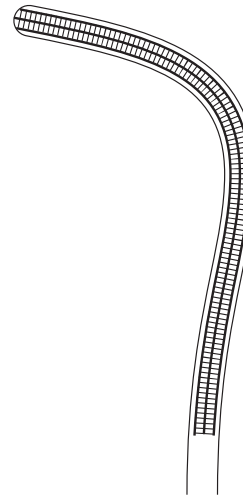

**B554020**



**B554010**

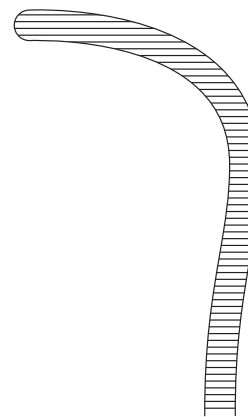

**B554025**



# LANDANGER

Pinces clamps - Clamp forceps - Pinzas clamps

MICHON

LEGUEU



A doigt  
Collin's lock  
Desmontable

IV - Pinces  
IV - Forceps  
IV - Pinzas

**B55260**  
24 cm - 9 1/2 "

**B55280**  
24 cm - 9 1/2 "

# LANDANGER

Pinces clamps - Clamp forceps - Pinzas clamps



GOUILLOUD

TOUPET

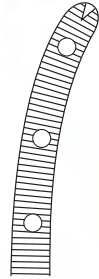
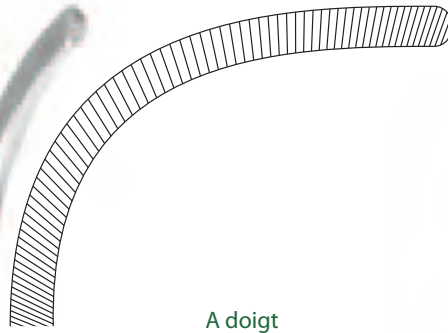

A doigt  
Collin's lock  
Desmontable

**B55300**  
22 cm - 8 <sup>3</sup>/<sub>4</sub> "

**B55310**  
24 cm - 9 <sup>1</sup>/<sub>2</sub> "

**IV - 38**

IV - Pinces  
IV - Forceps  
IV - Pinzas

# LANDANGER

Pinces hémostatiques longues - Long haemostatic forceps - Pinzas hemostaticas largas



BOZEMANN



**B50636**  
25 cm - 10 "

IV - Pinces  
IV - Forceps  
IV - Pinzas

**IV - 39**

# LANDANGER

Pinces passe-fil, dissecteurs - Ligature forceps, dissectors - Disecadores



REDON

BABY-ADSON

Courbe  
Curved  
Curva

14 cm - 5 1/2"

**B605300**

18 cm - 7"

**B605301**

IV - Pinces  
IV - Forceps  
IV - Pinzas



**B60535**  
14 cm - 5 1/2 "

**IV - 40**



**B605300**  
14 cm - 5 1/2 "

**B605300**

**B605301**

# LANDANGER

Pinces passe-fil, dissecteurs - Ligature forceps, dissectors - Disecadores



## O'SHAUGNESSY

45° Fin  
45° Fine  
45° Fino

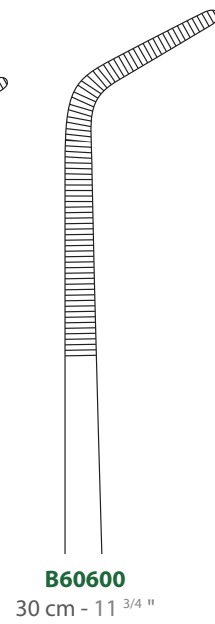
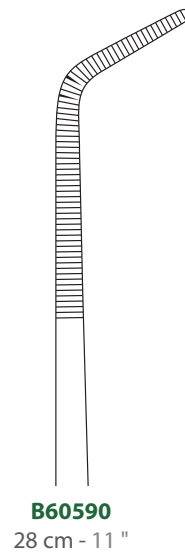
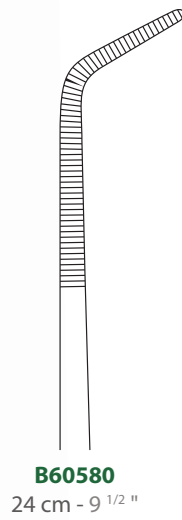
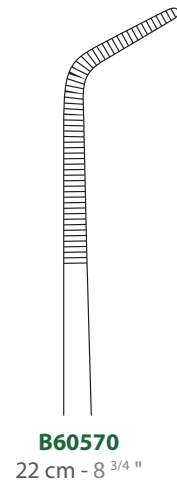
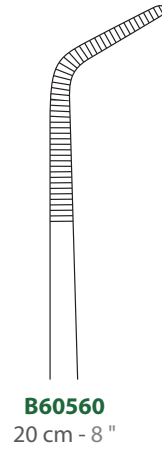
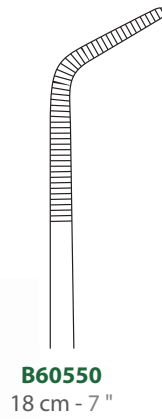
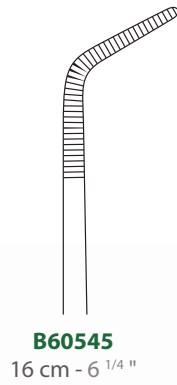
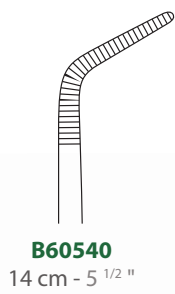

IV - Pincas  
IV - Forceps  
IV - Pinzas

# LANDANGER

Pinces passe-fil, dissecteurs - Ligature forceps, dissectors - Disecadores



## O'SHAUGNESSY

90° Fin  
90° Fine  
90° Fino

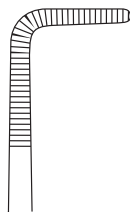

**B60601**  
14 cm - 5 1/2 "

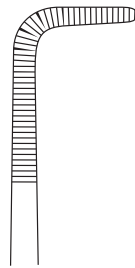

**B60602**  
16 cm - 6 1/4 "

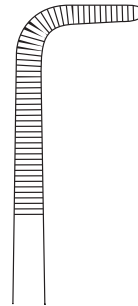

**B60603**  
18 cm - 7 "

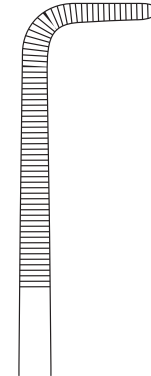

**B60604**  
20 cm - 8 "

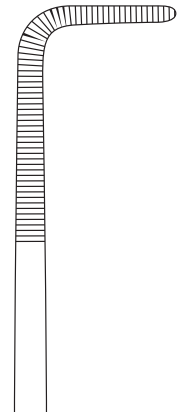

**B60605**  
22 cm - 8 3/4 "

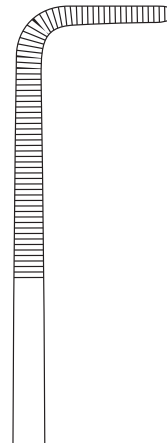

**B60606**  
24 cm - 9 1/2 "

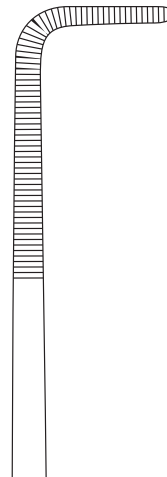

**B60607**  
28 cm - 11 "

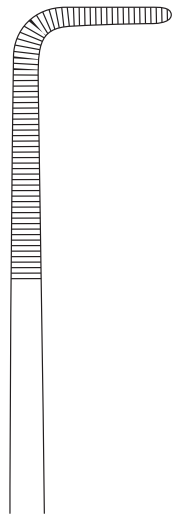

**B60608**  
30 cm - 11 3/4 "



**B60602**  
16 cm - 6 1/4 "

**IV - 42**

IV - Pincas  
IV - Forceps  
IV - Pinzas

# LANDANGER

Pinces passe-fil, dissecteurs - Ligature forceps, dissectors - Disecadores

## O'SHAUGNESSY



45° Fort  
45° Strong  
45° Fuerte

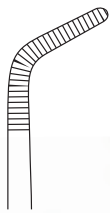

**B60610**  
14 cm - 5 1/2 "

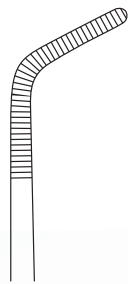

**B60615**  
16 cm - 6 1/4 "

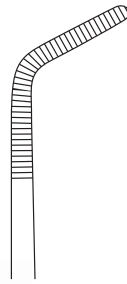

**B60620**  
18 cm - 7 "

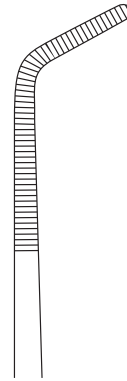

**B60630**  
20 cm - 8 "

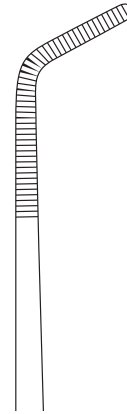

**B60640**  
22 cm - 8 3/4 "

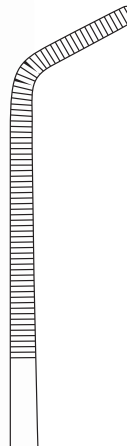

**B60650**  
24 cm - 9 1/2 "

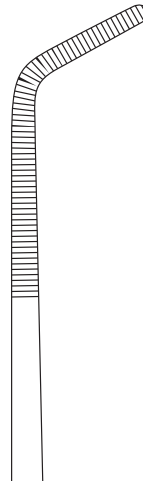

**B60660**  
28 cm - 11 "

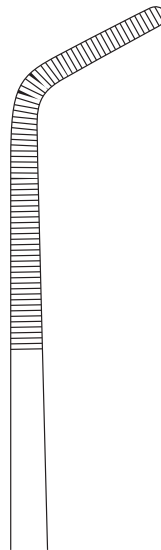

**B60670**  
30 cm - 11 3/4 "



**B60615**  
16 cm - 6 1/4 "

IV - Pinces  
IV - Forceps  
IV - Pinzas

# LANDANGER

Pinces passe-fil, dissecteurs - Ligature forceps, dissectors - Disecadores



## O'SHAUGNESSY

90° Fort  
90° Strong  
90° Fuerte

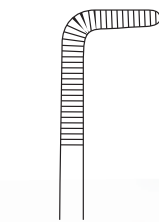

**B60710**  
14 cm - 5 1/2 "

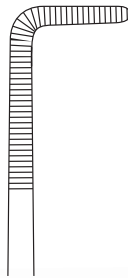

**B60715**  
16 cm - 6 1/4 "

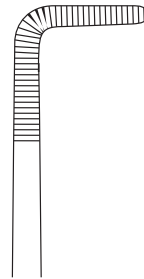

**B60720**  
18 cm - 7 "

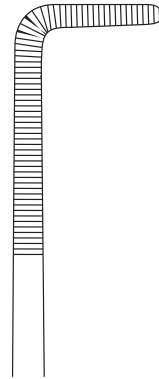

**B60730**  
20 cm - 8 "

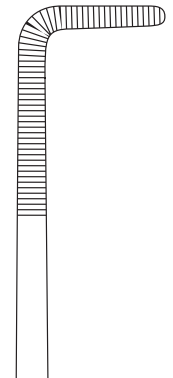

**B60740**  
22 cm - 8 3/4 "

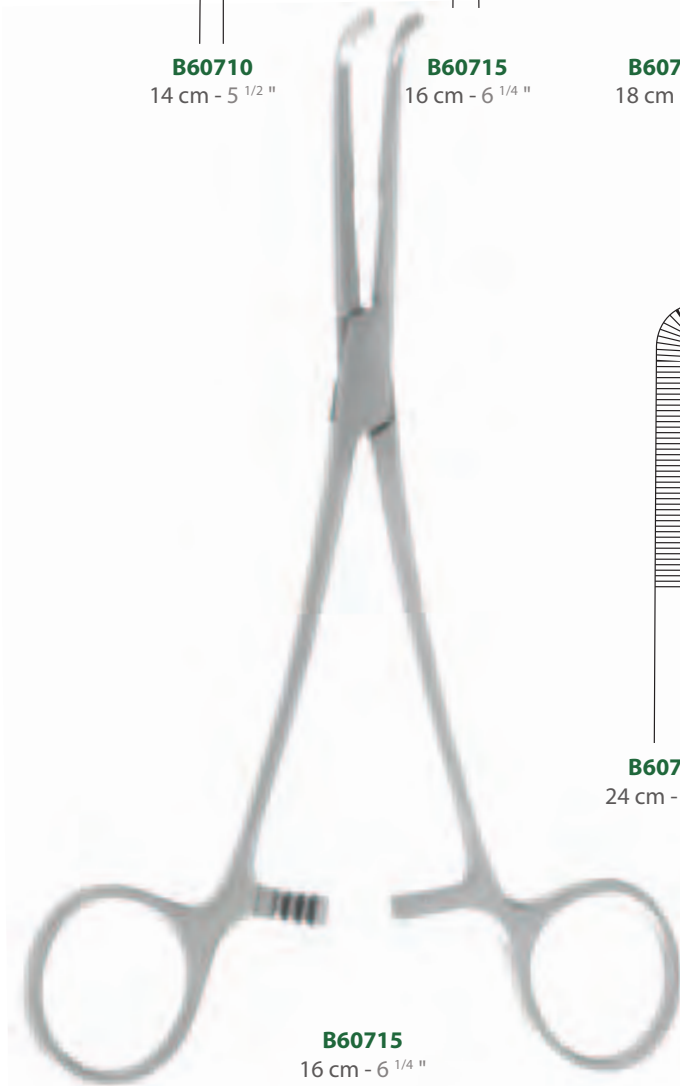

**B60715**  
16 cm - 6 1/4 "

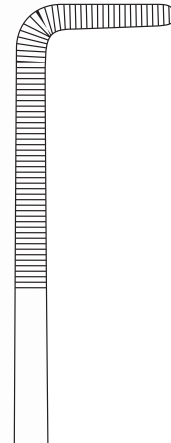

**B60750**  
24 cm - 9 1/2 "

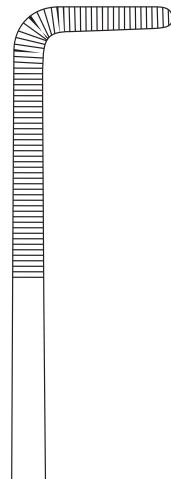

**B60752**  
28 cm - 11 "

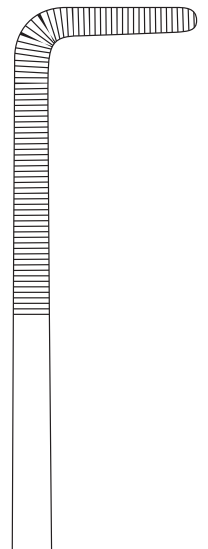

**B60753**  
30 cm - 11 3/4 "

IV - Pinces  
IV - Forceps  
IV - Pinzas

IV - 44



# LANDANGER

Pinces passe-fil, dissecteurs - Ligature forceps, dissectors - Disecadores



## O'SHAUGNESSY

Double courbure  
Double bend  
Dobla curvatura

Très courbe  
Very curved  
Muy curva

## ALLAINE

21,5 cm - 8 1/2"

**B60894**

26,5 cm - 10 1/2"

**B60895**

Double courbure  
Double bend  
Dobla curvatura



**B60700**  
24 cm - 9 1/2"

**B60756**  
22 cm - 8 3/4"

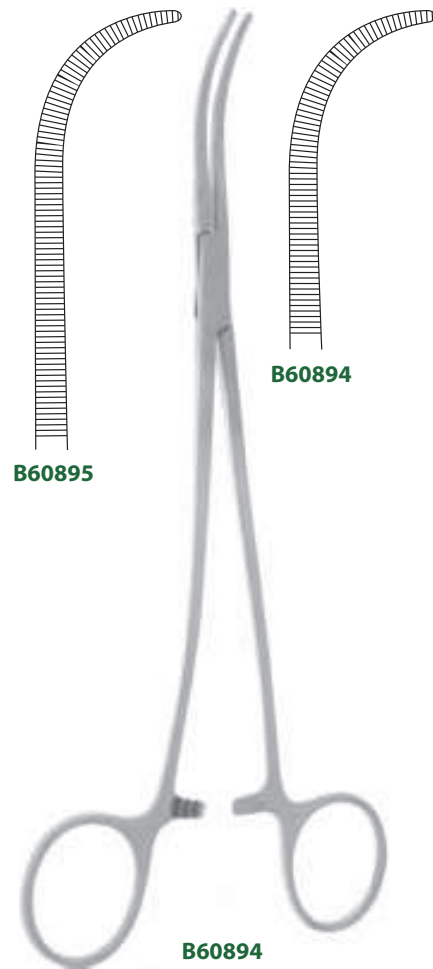

**B60895**

**B60894**

**B60894**  
21,5 cm - 8 1/2"

IV - Pinces  
IV - Forceps  
IV - Pinzas

**IV - 45**

# LANDANGER

Pinces passe-fil, dissecteurs - Ligature forceps, dissectors - Disecadores



## OVERHOLT- GEISSENDORFER

IV - Pinces  
IV - Forceps  
IV - Pinzas

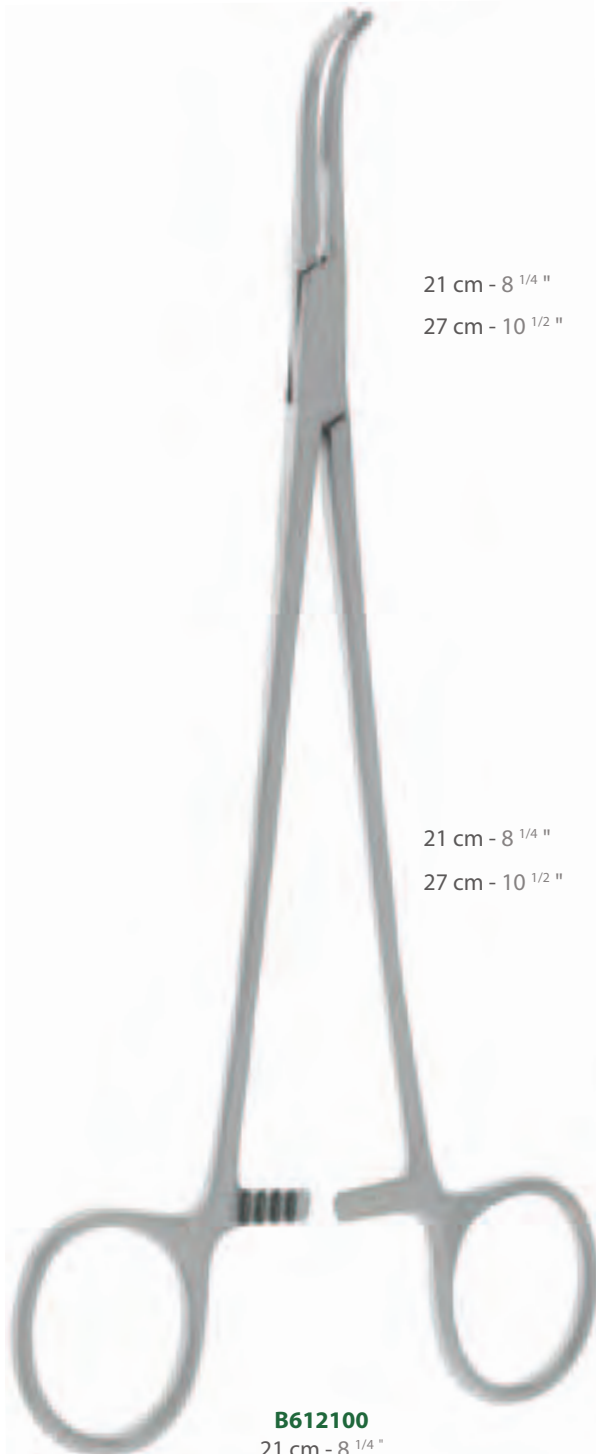

21 cm - 8 1/4 "

27 cm - 10 1/2 "

**B612100**  
21 cm - 8 1/4 "

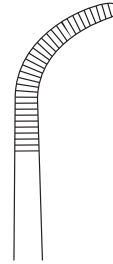

**B612100**

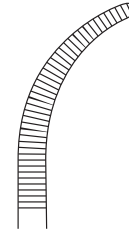

**B612110**

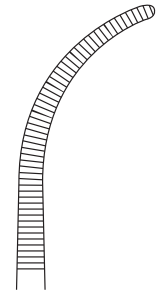

**B612120**

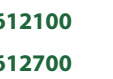

**B612700**



**B612710**



**B612720**

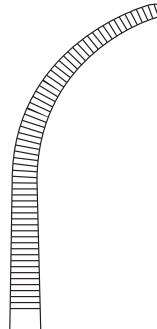

**B612130**

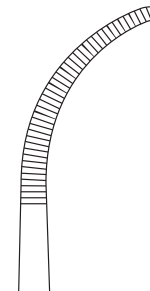

**B612140**

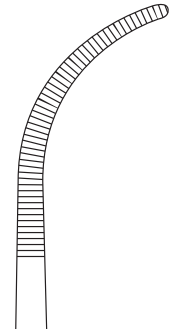

**B612150**



**B612730**



**B612740**



**B612750**

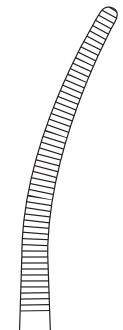

21 cm - 8 1/4 "

**B612160**

27 cm - 10 1/2 "

**B612760**

**IV - 46**

# LANDANGER

Pinces passe-fil, dissecteurs - Ligature forceps, dissectors - Discadores

## OVERHOLT-SLIM

Double courbure  
Double bend  
Doble curvatura

**B605000**  
18,5 cm - 7 1/4 "

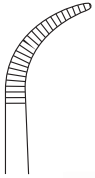

**B605001**  
20,5 cm - 8 "

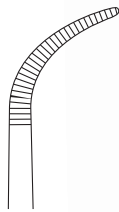

**B605002**  
21 cm - 8 1/4 "

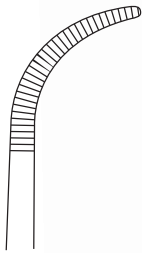

**B605003**  
21,5 cm - 8 1/2 "

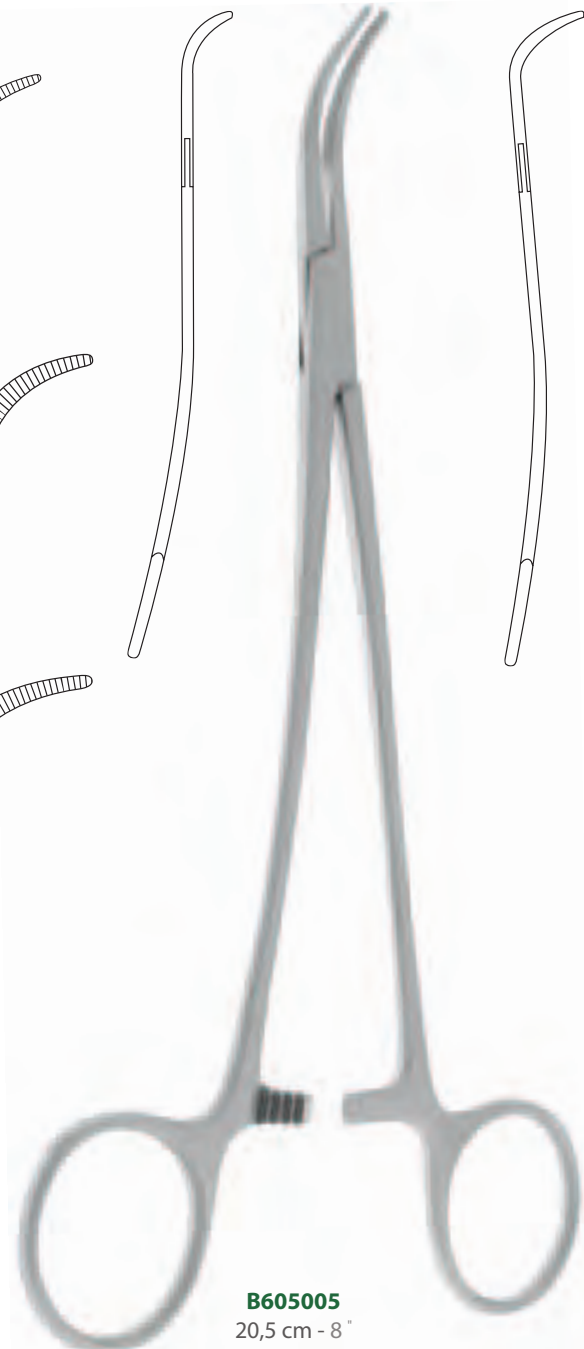
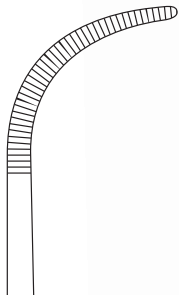

**B605005**  
20,5 cm - 8 "

## OVERHOLT-S



Courbe "S"  
"S" curved  
Curva "S"

**B605004**  
18,5 cm - 7 1/4 "

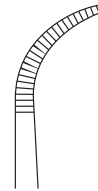

**B605005**  
20,5 cm - 8 "

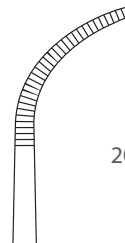

**B605006**  
21 cm - 8 1/4 "

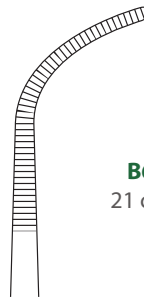

**B605007**  
21,5 cm - 8 1/2 "

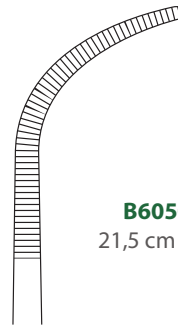

**B605008**  
24 cm - 9 1/2 "

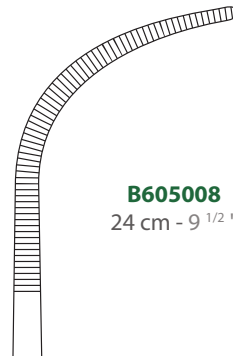

IV - Pinces  
IV - Forceps  
IV - Pinzas

# LANDANGER

Pinces passe-fil, dissecteur - Ligature forceps, dissectors - Disecador



## SCHNIDT

Courbe  
Curved  
Curva

Très courbe  
Very curved  
Muy curva

19 cm - 7 1/2"

**B609000**

**B609001**

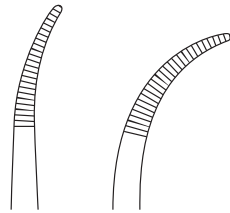

**B609000**

19 cm - 7 1/2"

## JACOBSON-ADSON

Droit  
Straight  
Recta

Courbe  
Curved  
Curva

Très courbe  
Very curved  
Muy curva

18 cm - 7"

**B609104**

**B609105**

**B609106**

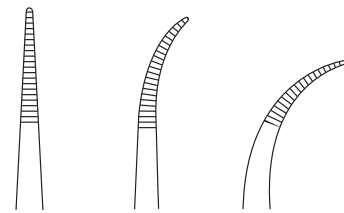

Très fine  
Very fine  
Muy finas

**B609105**

18 cm - 7"

IV - Pinces  
IV - Forceps  
IV - Pinzas

**IV - 48**

# LANDANGER

Pinces passe-fil, dissecteur - Ligature forceps, dissectors - Disecador

## KANTROWITZ



19 cm - 7 1/2" **B607570**

24 cm - 9 1/2" **B607571**



IV - Pinces  
IV - Forceps  
IV - Pinzas

# LANDANGER

Pinces passe-fil, dissecteur - Ligature forceps, dissectors - Disecadores



## QUILICY FARISSE

20 cm - 8"	<b>B613000</b>
22 cm - 8 1/2"	<b>B613020</b>
24 cm - 9 1/2"	<b>B613040</b>
28 cm - 11"	<b>B613080</b>
30 cm - 11 3/4"	<b>B613100</b>

Sans crémaillère  
Without ratchet  
Sin cremallera

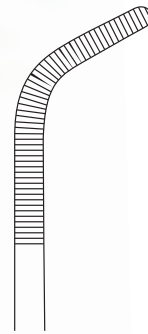

**B613000**

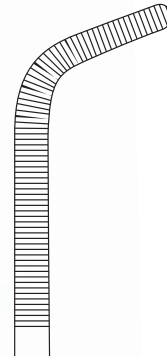

**B613040**

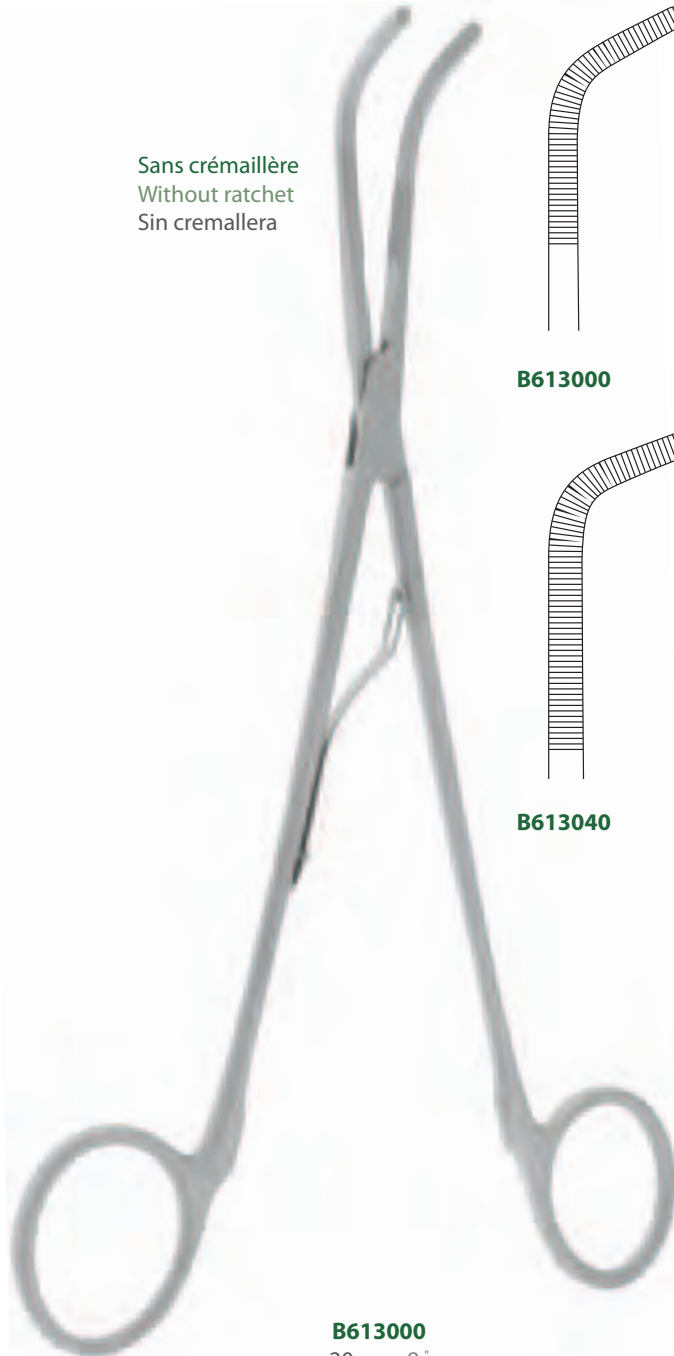

**B613000**  
20 cm - 8"

IV - Pinces  
IV - Forceps  
IV - Pinzas

**IV - 50**

# LANDANGER

Pinces passe-fil, dissecteur - Ligature forceps, dissectors - Disecadores

## RUMEL

1/2 courbe  
1/2 curved  
1/2 curva

**B613110**

Courbe  
Curved  
Curva

**B613111**

Très courbe  
Very curved  
Muy curva

**B613112**

23 cm - 9"

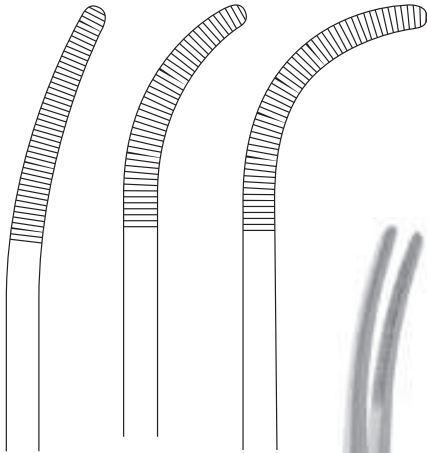

**B613110**  
23 cm - 9"

## MEEKER

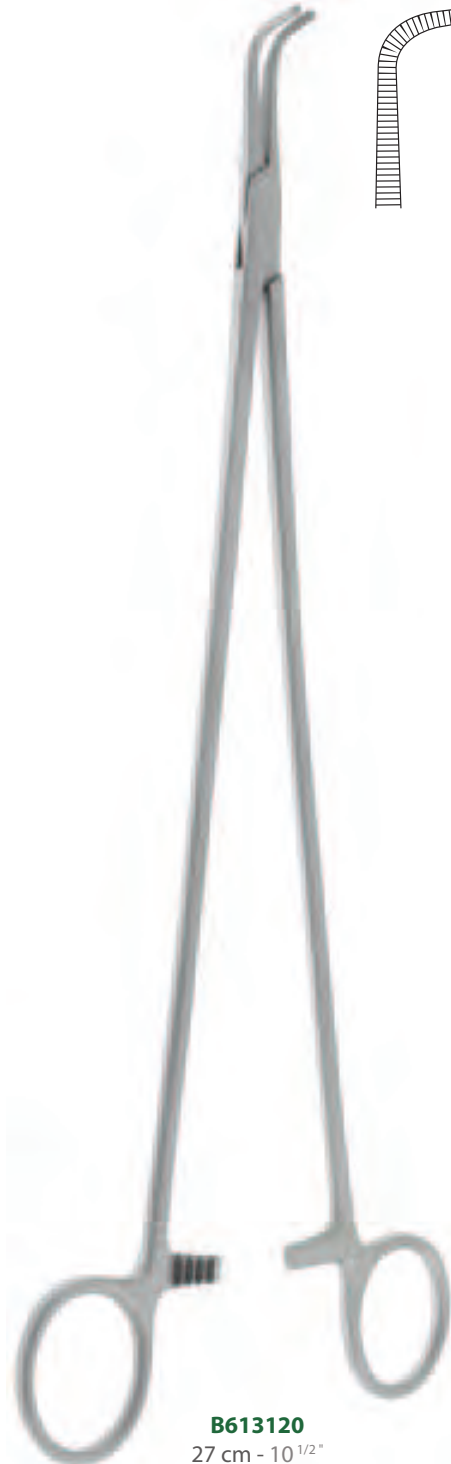
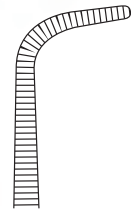

**B613120**  
27 cm - 10 1/2"

IV - Pinces  
IV - Forceps  
IV - Pinzas

# LANDANGER

Pinces passe-fil, dissecteur - Ligature forceps, dissectors - Disecadores

4/5

SEMB

SEMB-SAYLOR

IV - Pinces  
IV - Forceps  
IV - Pinzas

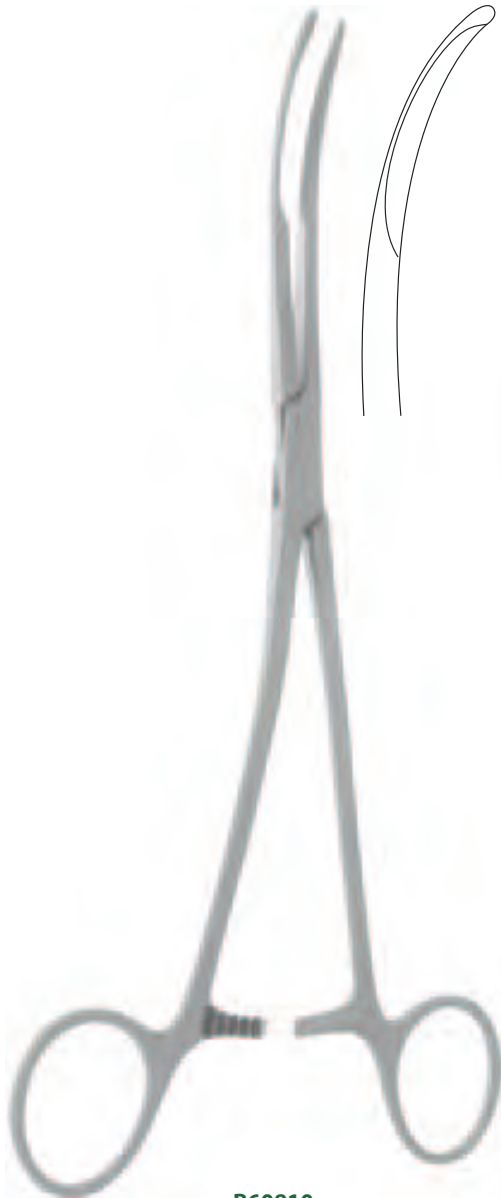

**B60810**  
22 cm - 8 <sup>3</sup>/<sub>4</sub> "

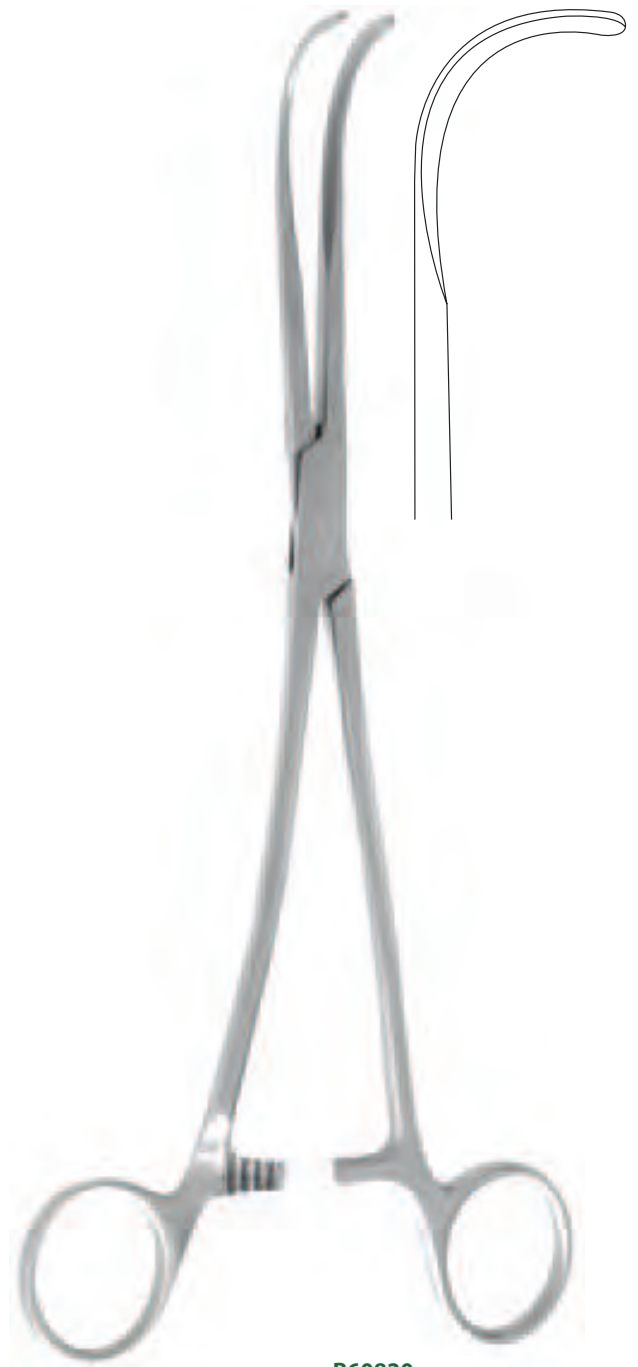

**B60820**  
25 cm - 10 "

**IV - 52**



# LANDANGER

Pinces passe-fil, dissecteur - Ligature forceps, dissectors - Disecadores



## BARRAYA



**B60860**

21 cm - 8 1/4 "



**B60870**

21 cm - 8 1/4 "

IV - Pinces  
IV - Forceps  
IV - Pinzas

**IV - 53**

# LANDANGER

Pinces passe-fil, dissecteur - Ligature forceps, dissectors - Discadores

1/1

## FINOCHIETTO

IV - Pincas  
IV - Forceps  
IV - Pinzas



**B60891**  
20 cm - 8 "

**IV - 54**

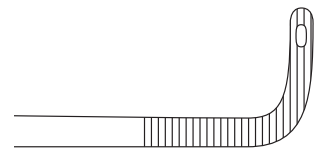

**B60891**  
20 cm - 8 "

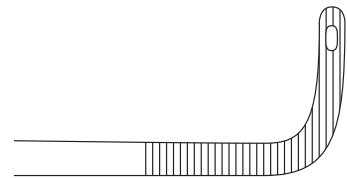

**B60892**  
24 cm - 9 1/2 "

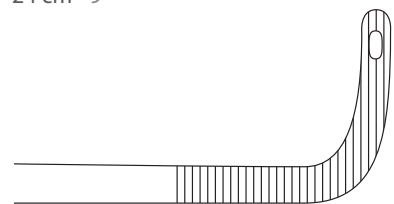

**B60893**  
30 cm - 11 3/4 "

# LANDANGER

Pinces passe-fil, dissecteur - Ligature forceps, dissectors - Disecadores

## HARRINGTON

31 cm - 12 1/4" **B607572**

30,5 cm - 12" **B607574**

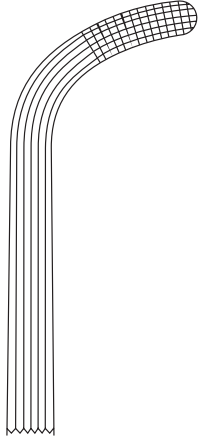

**B607572**

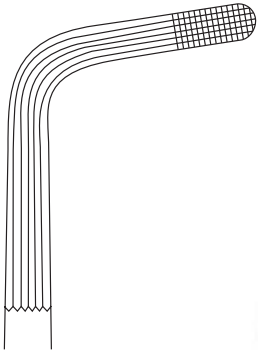

**B607574**

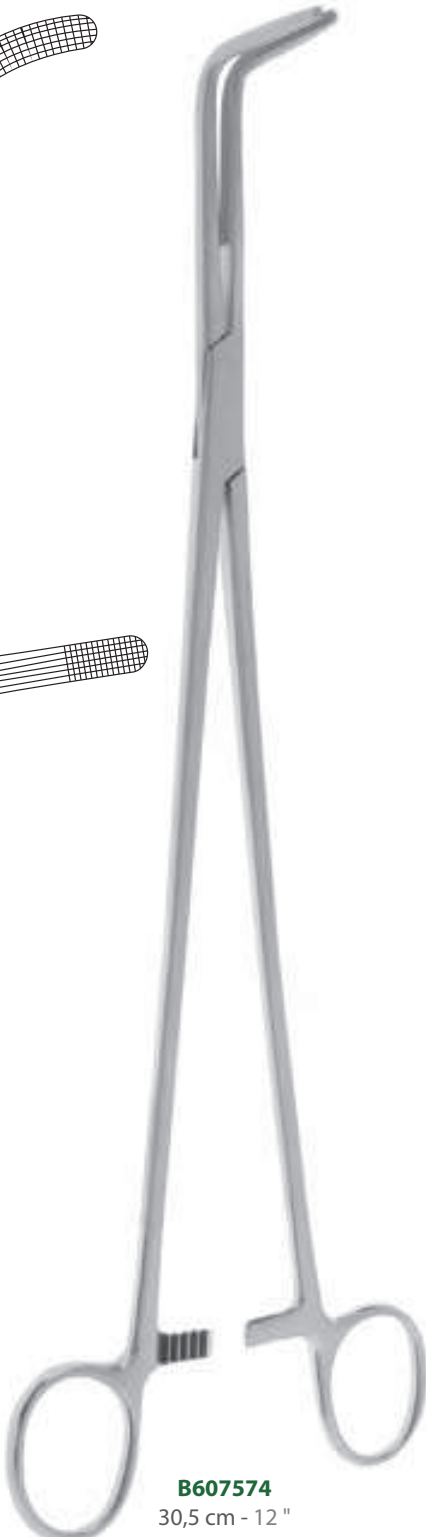

**B607574**  
30,5 cm - 12"

## RESANO



Double courbure  
Double bend  
Doble curvatura

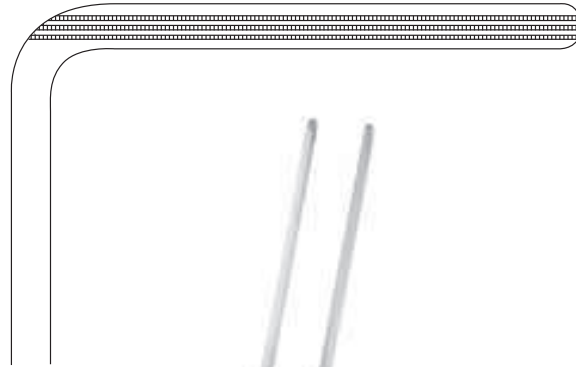

**B640000**  
30 cm - 11 3/4"

IV - Pinces  
IV - Forceps  
IV - Pinzas

# LANDANGER

Pinces clamps intestinales et stomacales - Intestinal and stomach clamp forceps - Pinzas clamps intestinales y estomacales



## QUENU

## HARTMANN

IV - Pinces  
IV - Forceps  
IV - Pinzas

Droite  
Straight  
Recta

Courbe  
Curved  
Curva

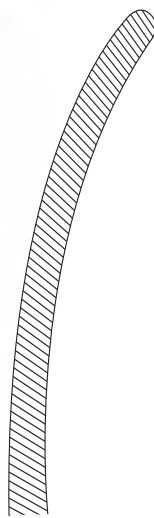
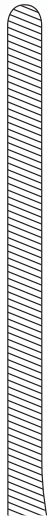

**B650900**

**B651000**

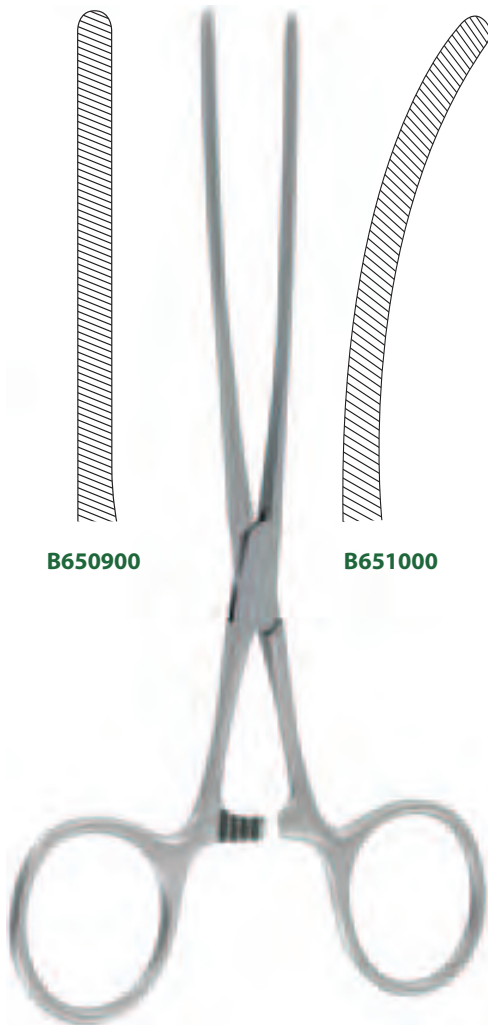

Droite  
Straight  
Recta

Courbe  
Curved  
Curva

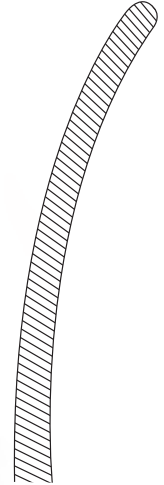
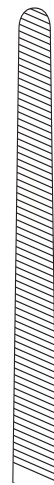

**B65070**

**B65080**

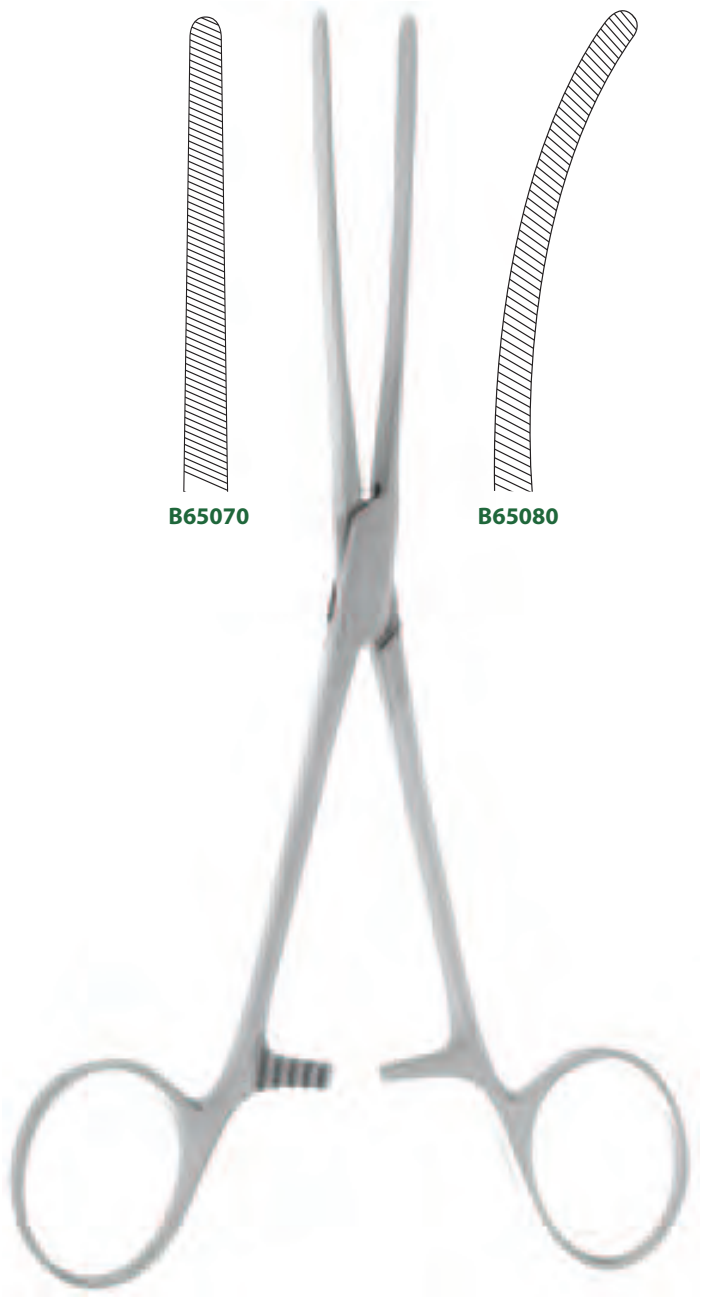

**B650900**  
15 cm - 6 "

**B65070**  
19 cm - 7 1/2 "

**IV - 56**

# LANDANGER

Pinces clamps intestinales et stomacales - Intestinal and stomach clamp forceps - Pinzas clamps intestinales y estomacales

## DOYEN

Droite	Courbe
Straight	Curved
Recta	Curva

22 cm - 8 3/4 "

**B65030**

**B65040**

## NEGUS



**B65040**  
22 cm - 8 3/4 "

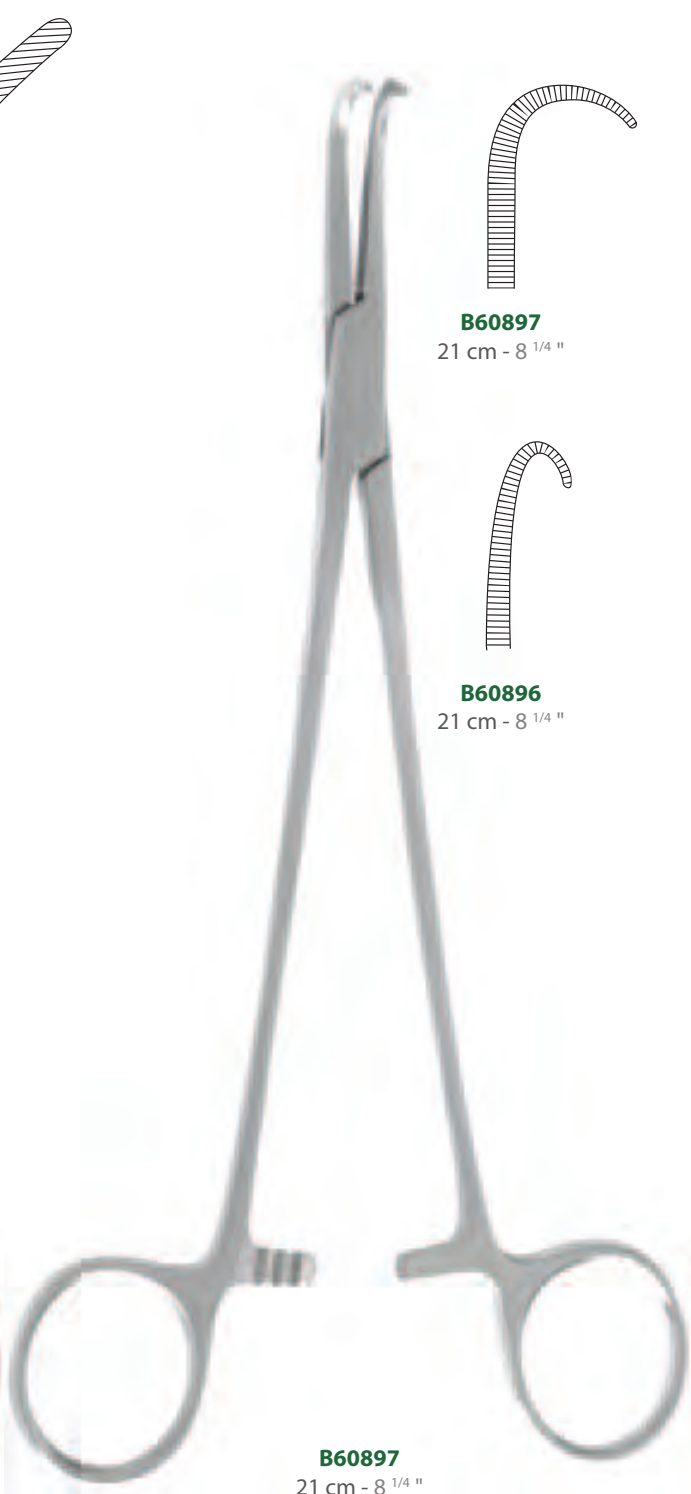

**B60897**  
21 cm - 8 1/4 "

**B60896**  
21 cm - 8 1/4 "

IV - Pinces  
IV - Forceps  
IV - Pinzas

**IV - 57**

# LANDANGER

## Pinces clamps intestinales et stomacales - Intestinal and stomach clamp forceps - Pinzas clamps intestinales y estomacales



1/2

Mors non traumatisants  
Non-traumatic jaws  
Boca no traumática

### BABY DOYEN

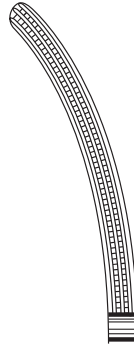

**C10860**  
13 cm - 5 "

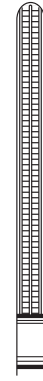

**C10855**  
13 cm - 5 "

IV - Pinces  
IV - Forceps  
IV - Pinzas

### MAYO ROBSON

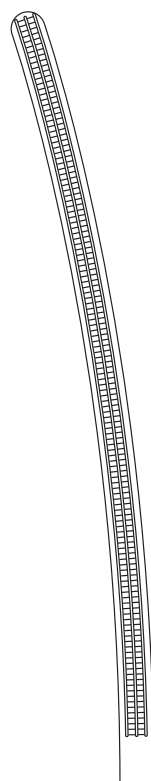

**C10905**  
25 cm - 10 "

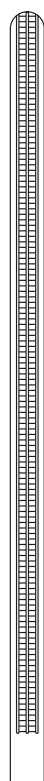

**C10900**  
25 cm - 10 "

### SCHEIBE

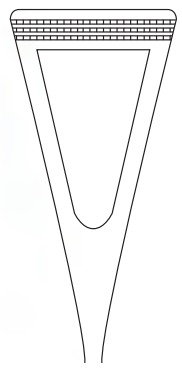

24 mm

**C10850**  
23 cm - 9 "

**IV - 58**

# LANDANGER

Pinces clamps intestinales et stomacales - Intestinal and stomach clamp forceps - Pinzas clamps intestinales y estomacales

Mors non traumatisants  
Non-traumatic jaws  
Boca no traumática



## DOYEN



**C10865**  
18 cm - 7 "

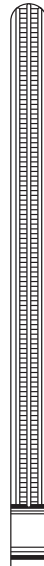

**C10870**  
21 cm - 8 1/4 "

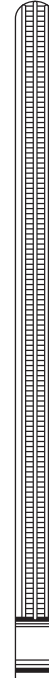

**C10875**  
23 cm - 9 "

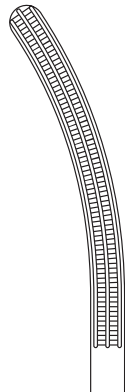

**C10880**  
18 cm - 7 "

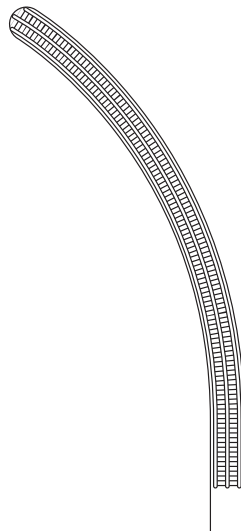

**C10890**  
21 cm - 8 1/4 "

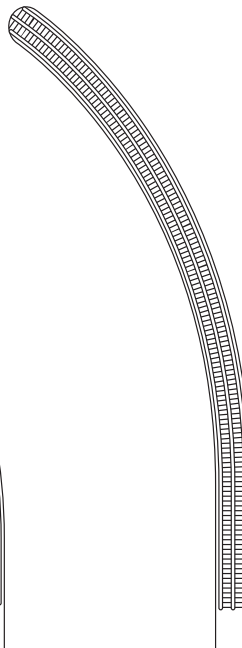

**C10895**  
23 cm - 9 "

IV - Pinces  
IV - Forceps  
IV - Pinzas

# LANDANGER

## Pinces clamps intestinales et stomacales - Intestinal and stomach clamp forceps - Pinzas clamps intestinales y estomacales



Mors non traumatisants  
Non-traumatic jaws  
Boca no traumática

### KOCHER

IV - Pinces  
IV - Forceps  
IV - Pinzas

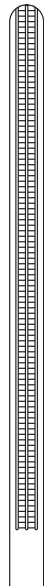

**C10910**  
22 cm - 8 <sup>3</sup>/<sub>4</sub> "

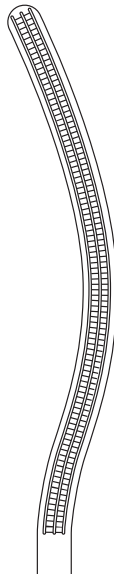

**C10925**  
22 cm - 8 <sup>3</sup>/<sub>4</sub> "

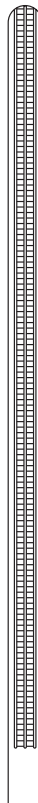

**C10915**  
25 cm - 10 "

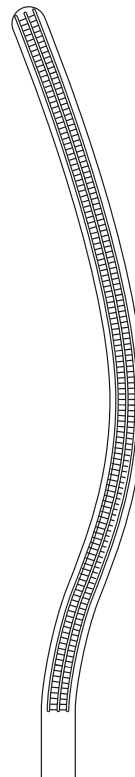

**C10930**  
25 cm - 10 "

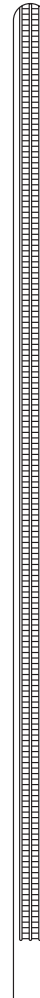

**C10920**  
28 cm - 11 "

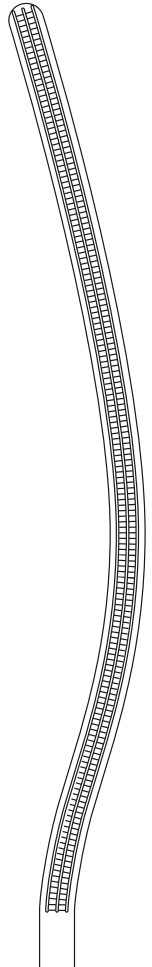

**C10935**  
28 cm - 11 "

**IV - 60**



# LANDANGER

Pinces clamps intestinales et stomacales - Intestinal and stomach clamp forceps - Pinzas clamps intestinales y estomacales

PAYR

1/3

Pour enfant  
For children  
Para niños



**C109500**  
15 cm - 5 3/4 "



**C109501**  
21 cm - 8 1/4 "



**C109502**  
29 cm - 11 1/2 "



**C109503**  
35 cm - 13 3/4 "



IV - Pinces  
IV - Forceps  
IV - Pinzas

# LANDANGER

Pinces à préhension - Grasping clamps - Pinzas a presión



## PRICE THOMAS

Pinces clamps à bronches  
Bronchus clamps  
Pinzas clamps para bronquios



**B60885**  
22 cm - 8 3/4 "



**B60880**

Sans griffes  
Without teeth  
Sin dientes



**B60885**

Griffes à droite  
Teeth on the right  
Dientes a la derecha



**B60890**

Griffes à gauche  
Teeth on the left  
Dientes a la izquierada

IV - Pinces  
IV - Forceps  
IV - Pinzas

**IV - 62**

# LANDANGER

Pinces à préhension - Grasping forceps - Pinzas a presión

DE MARTEL

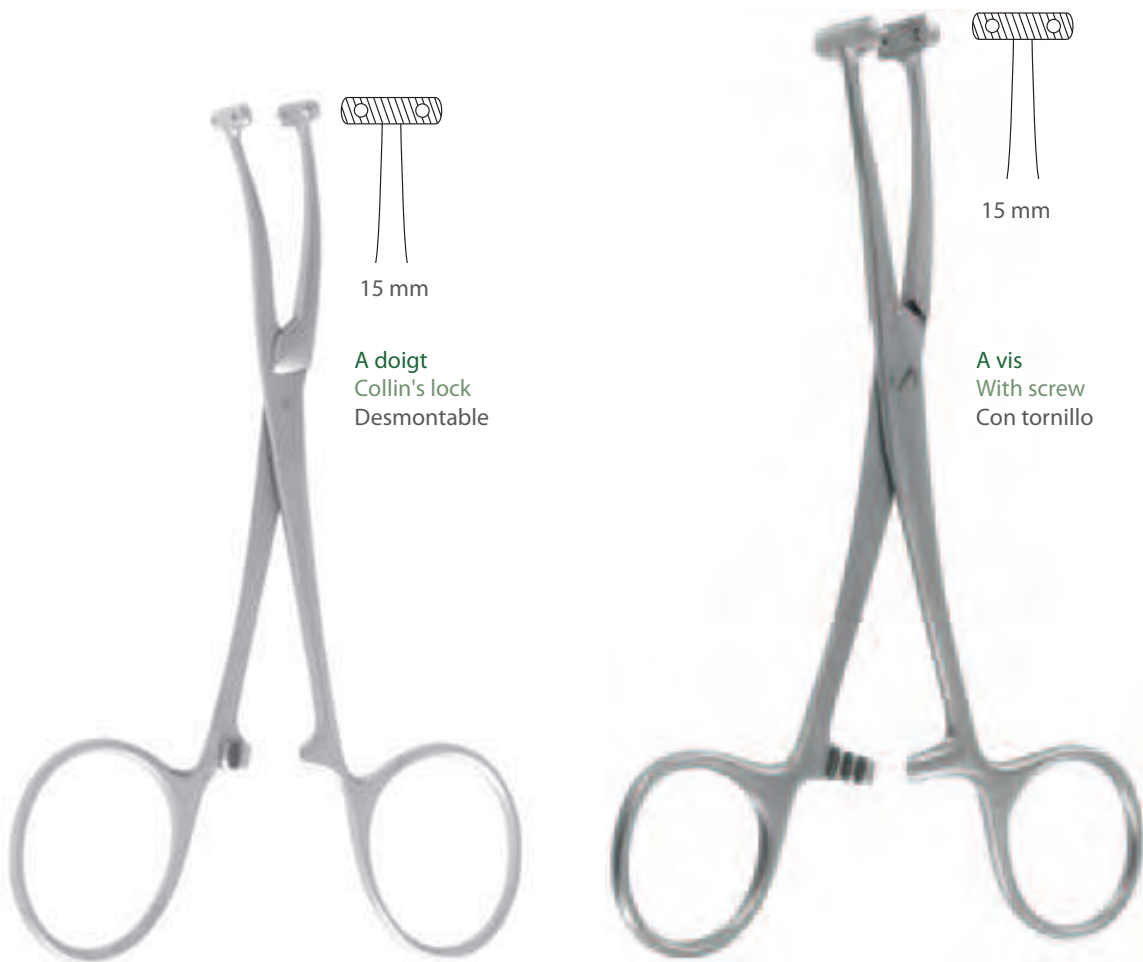

**B65135**  
13 cm - 5 "

**B651350**  
14 cm - 5 1/2 "

IV - Pinces  
IV - Forceps  
IV - Pinzas

**IV - 63**

# LANDANGER

## Pinces à préhension - Grasping forceps - Pinzas a presión



En coeur  
Heart-shaped  
Figura de corazon

Atraumatique  
Non-traumatic  
No traumática

IV - Pinces  
IV - Forceps  
IV - Pinzas



**B65119**  
16 cm - 6 1/4 "

A doigt  
Collin's lock  
Desmontable

**B65113**  
16 cm - 6 1/4 "

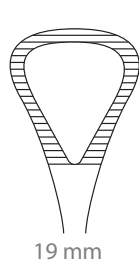

19 mm



**B65120**  
20 cm - 8 "

**B65123**  
22 cm - 8 3/4 "  
Légère - Light - Ligera

**B65125**  
22 cm - 8 3/4 "  
Forte - Strong - Fuerte

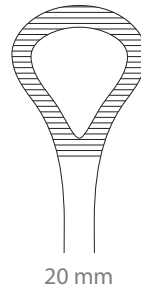

20 mm

**B65123**  
**B65125**

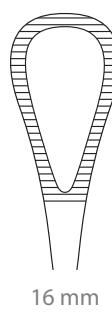

16 mm



**B65126**  
25 cm - 10 "

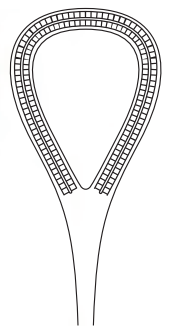

22 mm

# LANDANGER

Pinces à préhension - Grasping forceps - Pinzas a presión

## WALTER-DUVAL



16 cm - 6 1/4 " **B65230**

22 cm - 8 3/4 " **B65240**



**B65230**  
16 cm - 6 1/4 "

**B65250**  
22 cm - 8 3/4 "

IV - Pinces  
IV - Forceps  
IV - Pinzas

**IV - 65**

# LANDANGER

Pinces à préhension - Grasping forceps - Pinzas a presión



IV - Pinces  
IV - Forceps  
IV - Pinzas

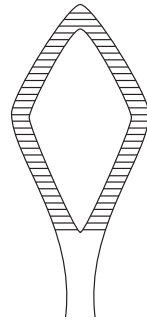

Losange  
Diamond  
Rombo

**B65127**  
16 cm - 6 1/4 "

**B651280**  
20 cm - 8 "

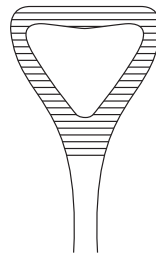

Triangle  
Triangular  
Triángulo

**B65129**  
16 cm - 6 1/4 "

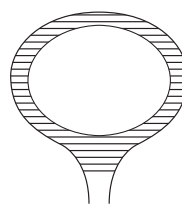

Ovale  
Oval  
Óvalo

**B65131**  
16 cm - 6 1/4 "

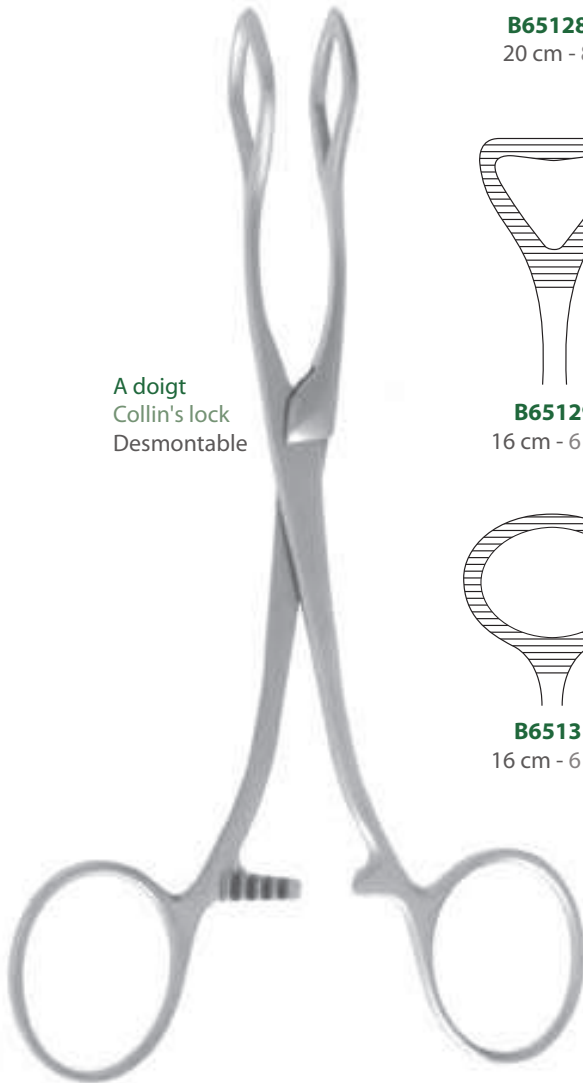

A doigt  
Collin's lock  
Desmontable

**B65127**  
16 cm - 6 1/4 "



**B651280**  
20 cm - 8 "

IV - 66

# LANDANGER

Pinces à préhension - Grasping forceps - Pinzas a presión

## DUVAL



Striures horizontales  
Horizontal streaking  
Estrizados horizontales

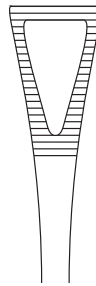

**B65190**  
13 mm  
22 cm - 8 3/4 "

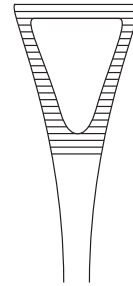

**B65191**  
18 mm  
22 cm - 8 3/4 "

Dents pénétrantes  
Penetrating teeth  
Dientes penetrantes

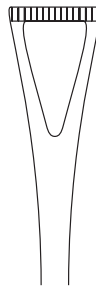

**B65192**  
13 mm  
22 cm - 8 3/4 "

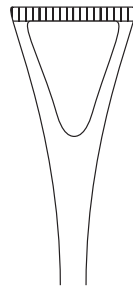

**B65193**  
18 mm  
22 cm - 8 3/4 "



**B65191**  
22 cm - 8 3/4 "

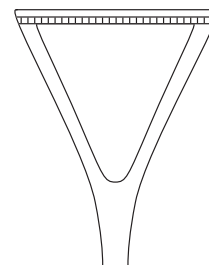

**B65170**  
30 mm  
20 cm - 8 "

A doigt  
Collin's lock  
Desmontable

IV - Pinces  
IV - Forceps  
IV - Pinzas

# LANDANGER

Pinces à préhension - Grasping forceps - Pinzas a presión



DUVAL

Mors tungstène  
Tungsten jaws  
Bocas de tungsteno

Mors non traumatisants  
Non-traumatic jaws  
Bocas no traumáticas



**B65210**  
20 cm - 8"

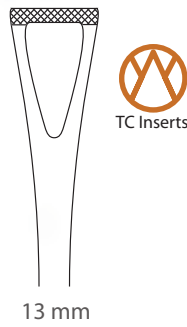

13 mm



**B65215**  
20 cm - 8"

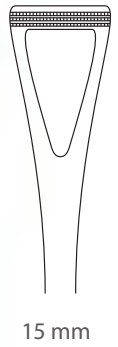

15 mm

IV - Pinces  
IV - Forceps  
IV - Pinzas

**IV - 68**



# LANDANGER

Pinces à préhension - Grasping forceps - Pinzas a presión

## PENNINGTON

15 cm - 6 " **B651500**  
20 cm - 8 " **B651550**

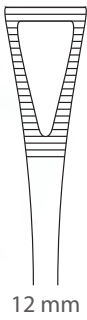

**B651550**  
20 cm - 8 "

## COLLIN



Dents pénétrantes  
Penetrating teeth  
Dientes penetrantes

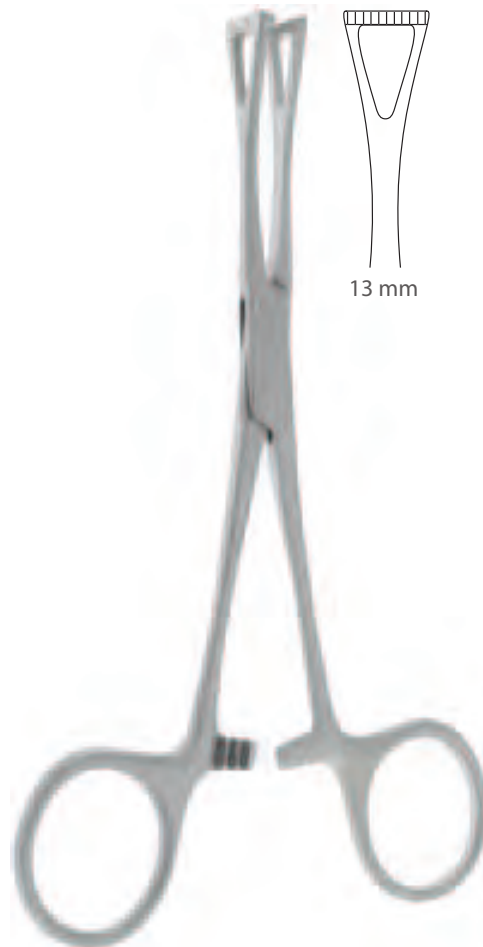

**B651560**  
14 cm - 5 1/2 "

IV - Pinces  
IV - Forceps  
IV - Pinzas

# LANDANGER

Pinces à préhension - Grasping forceps - Pinzas a presión



## LOVELACE

## AUVERT

Pince à poumons  
Lung forceps  
Pinza pulmonar



28 mm



**B655370**  
20 cm - 8 "

**B656025**  
20 cm - 8 "

**IV - 70**

IV - Pinces  
IV - Forceps  
IV - Pinzas

## GREGOIRE

Mors  
Jaws  
Boca

16 cm - 6 1/4 "	<b>B65290</b>	11 mm
22 cm - 8 3/4 "	<b>B65310</b>	13 mm



**B65290**  
16 cm - 6 1/4 "

IV - Pinces  
IV - Forceps  
IV - Pinzas

# LANDANGER

Pinces à préhension - Grasping forceps - Pinzas a presión



## CHAPUT

## CHAPUT-MAYO

13 cm - 5 1/8 " **B65330**

16 cm - 6 1/4 " **B65335**

20 cm - 8 " **B65370**

15 cm - 6 " **B65420**

20 cm - 8 " **B65430**

22 cm - 8 3/4 " **B65440**

IV - Pinces  
IV - Forceps  
IV - Pinzas



**B65335**  
16 cm - 6 1/4 "

**B65420**  
15 cm - 6 "

**IV - 72**

## ALLIS

4 et 5 griffes  
4 and 5 teeth  
4 y 5 dientes

15 cm - 6 "

**B65470**

5 et 6 griffes  
5 and 6 teeth  
5 y 6 dientes

15 cm - 6 "

**B65480**

20 cm - 8 "

**B65490**

Atraumatique  
Non-traumatic  
No traumática

16 cm - 6 1/4 "

**B65495**

20 cm - 8 "

**B65500**



# LANDANGER

Pinces à préhension - Grasping forceps - Pinzas a presión

## BABY-ALLIS

## JUDD-ALLIS

15 cm - 6 " **B654610**

19 cm - 7 1/2 " **B654620**

IV - Pinces  
IV - Forceps  
IV - Pinzas



**IV - 74**

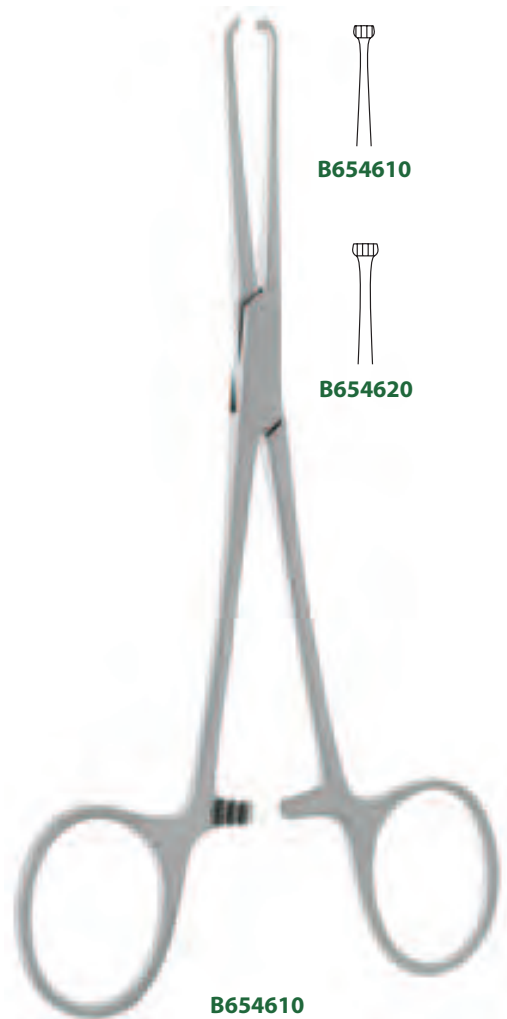

# LANDANGER

Pinces à préhension - Grasping forceps - Pinzas a presión

TUFFIER

LIEGE



**B65515**  
13 cm - 5 "



**B65530**  
24,5 cm - 9 3/4 "

IV - Pinces  
IV - Forceps  
IV - Pinzas

**IV - 75**

# LANDANGER

## Pinces à préhension - Grasping forceps - Pinzas a presión



### BABCOCK

16 cm - 6 1/4 " **B60370**  
 20 cm - 8 " **B60390**  
 24 cm - 9 1/2 " **B603950**

Non traumatisant  
 Non-traumatic  
 No traumático  
 16 cm - 6 1/4 " **B60422**  
 20 cm - 8 " **B60424**

Mors tungstène  
 Tungsten jaws  
 Tungsten boca  
 16 cm - 6 1/4 " **B60400**  
 20 cm - 8 " **B60420**

IV - Pinces  
 IV - Forceps  
 IV - Pinzas





# LANDANGER

Pinces à préhension - Grasping forceps - Pinzas a presión



**PRATT**



**B655340**  
15 cm - 6 "

**BENSON**



**B655360**  
15,5 cm - 6 1/8 "

IV - Pinces  
IV - Forceps  
IV - Pinzas

# LANDANGER

Pinces à champs - Towel forceps - Pinzas de compo

1/1

## DOYEN



**B70070**  
18 cm - 7 "

## SCHADEL

Crabe  
Crabe  
Cangrejo



**B70100**  
9 cm - 3 1/2 "

## JONES

Modèle britannique  
British model  
Modelo británico



**B702350**  
5 cm - 2 "



**B702300**  
9 cm - 3 1/2 "



**B702400**  
9 cm - 3 1/2 "

**B702355**  
9 cm - 3 1/2 "

**IV - 78**

IV - Pinces  
IV - Forceps  
IV - Pinzas

# LANDANGER

Pinces à champs - Towel forceps - Pinzas de campo

## BACKHAUS



**B70130**  
9 cm - 3 1/2 "



**B70140**  
11 cm - 4 1/4 "



**B70150**  
13 cm - 5 "



**B70160**  
14 cm - 5 1/2 "

IV - Pinces  
IV - Forceps  
IV - Pinzas

**IV - 79**

# LANDANGER

Pinces à champs - Towel forceps - Pinzas de campo



## BACKHAUS

Porte-tube  
Tube holder  
Soporte para tubo



**B70190**  
14 cm - 5 1/2 "

## PEERS

Non perforante  
Non-perforating  
No perforante



**B70200**  
14 cm - 5 1/2 "

IV - Pinces  
IV - Forceps  
IV - Pinzas

**IV - 80**

# LANDANGER

Pinces à champs - Towel forceps - Pinzas de campo



## TOHOKU

## LORNA

10 cm - 4 "

**B702450**

13 cm - 5 "

**B702451**

10 cm - 4 "

**B702500**

13 cm - 5 "

**B702505**



**B702450**  
10 cm - 4 "



**B702500**  
10 cm - 4 "

IV - Pinces  
IV - Forceps  
IV - Pinzas

# LANDANGER

## Pinces diverses - Miscellaneous forceps - Pinzas diversas



### GUNNAR-HEY

0 - 12 mm **B95100**

0 - 20 mm **B951020**

Pince compas à traire les drains  
Drainage-tube drawing forceps  
Pinza para ordenar las canulas



Aluminium  
Aluminum  
Aluminio



**B951030**  
16 cm - 6 1/4 "

Pince à traire les drains  
Drainage-tube drawing forceps  
Pinza para ordenar las canulas



**B95100**  
17 cm - 6 3/4 "

IV - Pinces  
IV - Forceps  
IV - Pinzas

**IV - 82**

## LOCHARD

Pince ouvre capsule  
Capsule-opening forceps  
Pinza para abrir las capsulas



## WEISS

Presse-tube  
Pinchoc clamps  
Cierra tubos





IV - Pincas  
IV - Forceps  
IV - Pinzas

## HOFFMAN



**B95017**  
17 mm - 2/3 "

**B95020**  
20 mm - 3/4 "

**B95025**  
25 mm - 1 "

## MOHR

Presse-tube  
Pinchoc clamps  
Cierra tubos



**B950450**  
50 mm - 2 "

**B950460**  
60 mm - 2 1/4 "

**B950470**  
70 mm - 2 3/4 "

**B950480**  
80 mm - 3 1/4 "



# LANDANGER

Pinces à prehension presse tube - Grasping forceps pinchoc clamps - Pinzas a presión cierra tubos



## MURPHY

14 cm - 5 1/2 "	<b>B95150</b>	
18 cm - 7 "	<b>B95200</b>	
19 cm - 7 1/2 "	<b>B95205</b>	Forte - Strong - Fuerte
20 cm - 8 "	<b>B95210</b>	

15 cm - 6 "	<b>B952014</b>
18 cm - 7 "	<b>B952018</b>
20 cm - 8 "	<b>B952020</b>

Avec barre de protection  
With safety rod  
Con estribo de protección



IV - Pinces  
IV - Forceps  
IV - Pinzas

# LANDANGER

Prestige Pinces hémostatiques - Prestige Haemostatic forceps - Pinzas hemostaticas Prestige



*Prestige*

HALSTEAD

A griffes    Sans griffes  
With teeth    Without teeth  
Con dientes    Sin dientes

12 cm - 4 <sup>3</sup>/<sub>4</sub> "

**B86500**

**B86505**

A griffes    Sans griffes  
With teeth    Without teeth  
Con dientes    Sin dientes

12 cm - 4 <sup>3</sup>/<sub>4</sub> "

**B86510**

**B86515**

IV - Pinces  
IV - Forceps  
IV - Pinzas

Droite  
Straight  
Recta

Courbe  
Curved  
Curva



IV - 86

# LANDANGER

Prestige Pincés hémostatiques - Prestige Haemostatic forceps - Pinzas hemostaticas Prestige



*Prestige*

## LERICHE

Droite Straight Recta	A griffes With teeth Con dientes	Sans griffes Without teeth Sin dientes	Courbe Curved Curva	A griffes With teeth Con dientes	Sans griffes Without teeth Sin dientes
15 cm - 6 "	<b>B86520</b>	<b>B86525</b>	15 cm - 6 "	<b>B86530</b>	<b>B86535</b>
18 cm - 7 "	<b>B86540</b>	<b>B86545</b>	18 cm - 7 "	<b>B86550</b>	<b>B86555</b>



**B86525**  
15 cm - 6 "

IV - Pincés  
IV - Forceps  
IV - Pinzas

# LANDANGER

Prestige Pincés hémostatiques - Prestige Haemostatic forceps - Pinzas hemostaticas Prestige

1/1

*Prestige*

**BENGOLEA**

Sans griffes  
Without teeth  
Sin dientes



**B86560**  
21 cm - 8 1/4"

**IV - 88**



**B86570**  
24 cm - 9 1/2"

IV - Pincés  
IV - Forceps  
IV - Pinzas

# LANDANGER

Prestige Pincés hémostatiques - Prestige Haemostatic forceps - Pinzas hemostaticas Prestige



*Prestige*

## KOCHER

## KELLY

A griffes  
With teeth  
Con dientes

Sans griffes  
Without teeth  
Sin dientes



**B86580**  
16 cm - 6 1/4"



**B86595**  
16 cm - 6 1/4"

Courbe  
Curved  
Curva

**B86590**

IV - Pincés  
IV - Forceps  
IV - Pinzas

**IV - 89**

# LANDANGER

Prestige Pincés hémostatiques - Prestige Haemostatic forceps - Pinzas hemostaticas Prestige



*Prestige*

CRILE

CHRISTOPHE

Sans griffes  
Without teeth  
Sin dientes

IV - Pincés  
IV - Forceps  
IV - Pinzas



**B86600**  
14 cm - 5 1/2 "



**B86610**  
16 cm - 6 1/4"

**IV - 90**

Clamps bulldog - Bulldog clamps - Clamp bulldog

DEBAKEY **Pince à poser** DEBAKEY GLOVER SANTULLI DEBAKEY CAROTID GLOVER DEBAKEY SATINSKY GREGORY SOFT CARREL  
 Setting forceps  
 Pinza para colocar



P 1

Pinces clamps cardiovasculaires atrauma - Atrauma cardiovascular forceps - Pinzas clamps cardiovasculares atrauma

DEBAKEY POTTS DEBAKEY LELAND JONES BAINBRIDGE DEBAKEY OCHSNER DIETRICH HARKEN LEES DEBAKEY WEBER



SATINSKY LAMBERT KAY BECK DEBAKEY MORRIS DEBAKEY DEBAKEY BAHNSON DEBAKEY PEAN DEBAKEY RANKIN



P 13 P 13 P 14 P 14 - P 15 ☒

DEBAKEY MOSQUITO DEBAKEY GLOVER DERRA DALE GREGORY SUBRAMANIAN DEBAKEY JAVID COOLEY



P 18 P 18 - P 19 P 19 - P 20 P 20 ☒

Pédiatrique - Pediatric - Pediatricos

COOLEY CASTANEDA



P 27 ☒

Divers - Miscellaneous - Diversos

MULLER RUMEL BELMONT



V - Clamps  
 V - Clamps  
 V - Clamps

II - Dissection  
II - Dissecting  
II - Disección

Pinces à dissection vasculaires - Vascular dissection forceps - Pinzas para disección vasculares

DEBAKEY



P 33

DEBAKEY



P 34

COOLEY



P 34

XV - Divers  
XV - Miscellaneous  
XV - Diversos

Divers - Miscellaneous - Diversos

HÉPARINE



P 24



# LANDANGER

## Clamps bulldog - Bulldog clamps - Clamp bulldog



### DEBAKEY



**C10070**  
10,5 cm - 4 "

	Droit Straight Recto	Courbe Curve Curvo
7,0 cm - 2 3/4 "	-	<b>C10080</b>
7,5 cm - 3 "	<b>C10060</b>	-
8,0 cm - 3 1/8 "	-	<b>C10085</b>
8,5 cm - 3 1/4 "	<b>C10065</b>	-
10,0 cm - 4 "	-	<b>C10090</b>
10,5 cm - 4 1/4 "	<b>C10070</b>	-
11,5 cm - 4 1/2 "	-	<b>C10095</b>
12 cm - 4 3/4 "	<b>C10075</b>	-



**C10090**  
10 cm - 3 3/4 "

**PINCE À POSER LES CLAMPS**  
**CLAMP SETTING FORCEPS**  
**PINZA PARA COLOCAR CLAMPS**



**C10100**  
24 cm - 9 1/2 "

### DEBAKEY GLOVER



**C10110**  
7 cm - 2 3/4 "

	Droit Straight Recto	Courbe Curve Curvo
5,5 cm - 2 1/8 "	-	<b>C10125</b>
6,0 cm - 2 1/4 "	<b>C10105</b>	-
6,5 cm - 2 1/2 "	-	<b>C10130</b>
7,0 cm - 2 3/4 "	<b>C10110</b>	-
8,5 cm - 3 1/4 "	-	<b>C10135</b>
9,0 cm - 3 1/2 "	<b>C10115</b>	-
11 cm - 4 1/4 "	<b>C10120</b>	<b>C10140</b>



**C10130**  
6,5 cm - 2 1/2 "

V - Clamps  
V - Clamps  
V - Clamps

# LANDANGER

Clamps bulldog - Bulldog clamps - Clamp bulldog



SANTULLI

DEBAKEY CAROTID

GLOVER



**C10096**  
7 cm - 2 3/4 "



**C10155**  
9 cm - 3 1/2 "



**C10160**  
5 cm - 2 "

V - Clamps  
V - Clamps  
V - Clamps

DEBAKEY SATINSKY

GREGORY SOFT



7 cm - 2 3/4 "  
10 cm - 4 "

**C10145**

**C10150**

**C10150**  
10 cm - 4 "



9 cm - 3 1/2 "  
11 cm - 4 1/4 "

**C10098**

**C10099**

**C10099**  
11 cm - 4 1/4 "

**V - 2**

# LANDANGER

## Clamps bulldog - Bulldog clamps - Clamp bulldog



**C10185**  
6 cm - 2 1/4 "

STANDARD  
STANDARD  
STANDARD

Droit  
Straight  
Recto

Courbe  
Curve  
Curvo

3 cm - 1 1/4 "	<b>C10170</b>	<b>C10195</b>
4 cm - 1 1/2 "	<b>C10175</b>	<b>C10200</b>
5 cm - 2 "	<b>C10180</b>	<b>C10205</b>
6 cm - 2 1/4 "	<b>C10185</b>	<b>C10210</b>
7 cm - 2 3/4 "	<b>C10190</b>	<b>C10215</b>



**C10210**  
6 cm - 2 1/4 "



**C101851**  
6,5 cm - 2 1/2 "

FIN  
FINE  
FINO

Droit  
Straight  
Recto

Courbe  
Curve  
Curvo

3,5 cm - 1 1/3 "	<b>C101701</b>	<b>C101951</b>
4 cm - 1 1/2 "	<b>C101751</b>	<b>C102001</b>
5 cm - 2 "	<b>C101801</b>	<b>C102051</b>
6,5 cm - 2 1/2 "	<b>C101851</b>	<b>C102101</b>
7 cm - 2 3/4 "	<b>C101901</b>	<b>C102151</b>



**C102101**  
6,5 cm - 2 1/2 "

V - Clamps  
V - Clamps  
V - Clamps

## CARREL

Clamp pour lymphographie  
Lymphographia clamp  
Clamp para linfografía



**C10220**  
5 cm - 2 "

**V - 3**

# LANDANGER

Pinces clamps cardiovasculaires atrauma - Atrauma cardiovascular forceps - Pinzas clamps cardiovasculares atrauma



## DEBAKEY POTTS



Pour coarctation  
For coarctation  
Para coarctación

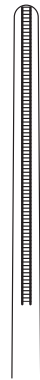

**C10265**  
21 cm - 8 1/4 "

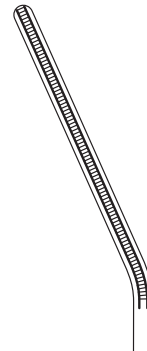

**C10275**  
21 cm - 8 1/4 "

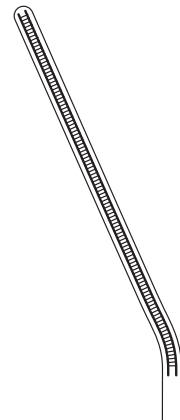

**C10280**  
22 cm - 8 "

**C10270**  
22 cm - 8 "

V - Clamps  
V - Clamps  
V - Clamps



Pour coarctation  
For coarctation  
Para coarctación



**C10285**  
21 cm - 8 1/4 "

**C10290**  
22 cm - 8 "

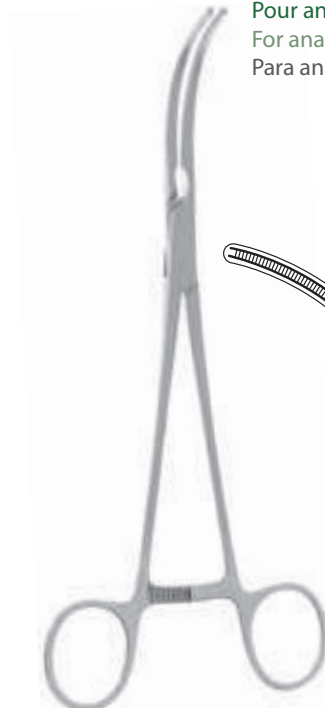

Pour anastomose  
For anastomosis  
Para anastomosis



**C10295**  
22 cm - 8 3/4 "

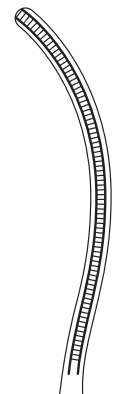

**C10300**  
22 cm - 8 3/4 "

**V - 4**

# LANDANGER

Pinces clamps cardiovasculaires atrauma - Atrauma cardiovascular forceps - Pinzas clamps cardiovasculares atrauma



Mors DeBaKey  
DeBaKey Jaws  
Boca DeBaKey

## DEBAKEY



Pour dissection et ligature  
For dissecting and ligature  
Para disección y ligaduras

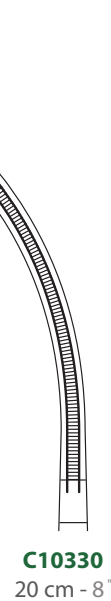
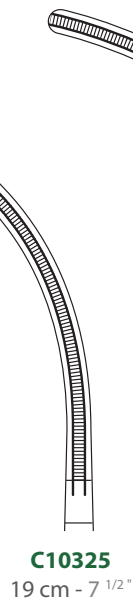
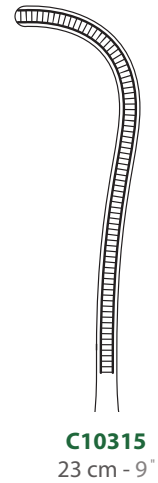
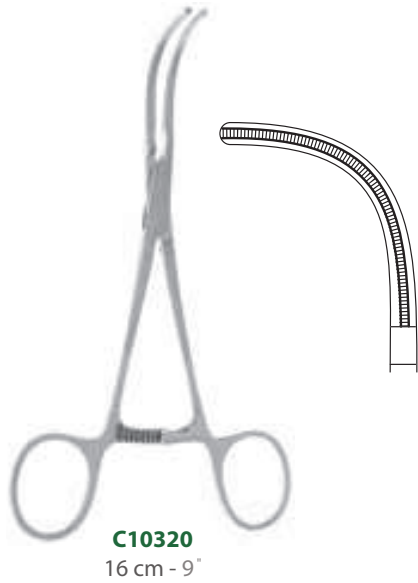

V - Clamps  
V - Clamps  
V - Clamps

**V-5**

# LANDANGER

Pinces clamps cardiovasculaires atrauma - Atrauma cardiovascular forceps - Pinzas clamps cardiovasculares atrauma



## LELAND JONES



Pour vaisseaux périphériques  
For peripheral vessels  
Para vasos perifericos

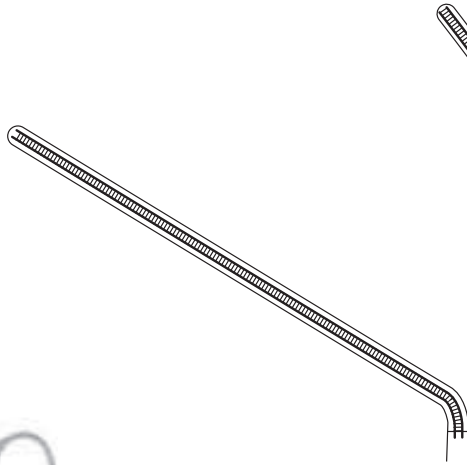

**C10335**  
18 cm - 7"

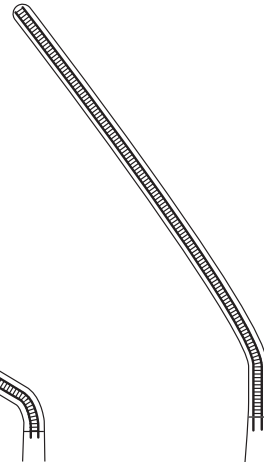

**C10340**  
19 cm - 7 1/2"

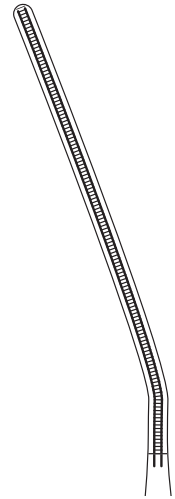

**C10345**  
20 cm - 8"

V - Clamps  
V - Clamps  
V - Clamps

## BAINBRIDGE



**C10350**  
15 cm - 6"



**C10355**  
18 cm - 7"

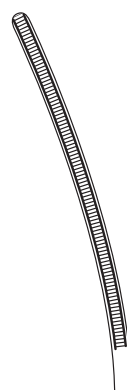

**C10360**  
15 cm - 6"

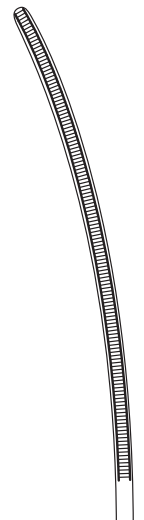

**C10365**  
18 cm - 7"

**V-6**

# LANDANGER

Pinces clamps cardiovasculaires atrauma - Atrauma cardiovascular forceps - Pinzas clamps cardiovasculares atrauma



Mors DeBaKey  
DeBaKey Jaws  
Boca DeBaKey

## DEBAKEY



Pour artère rénale  
For renal artery  
Para arteria renal



**C10370**  
20 cm - 8"

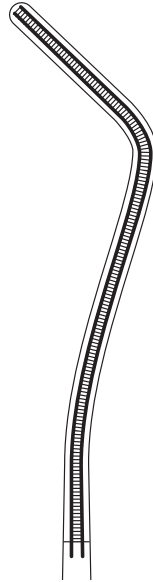

Pour anévrisme de l'aorte  
For aortic aneurysm  
Para aneurisma de la aorta

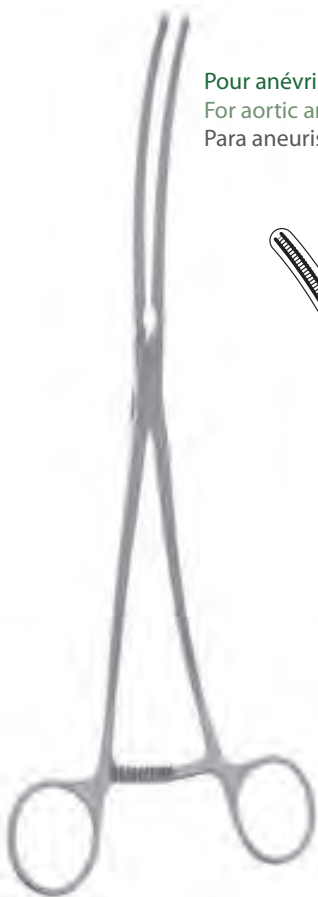

**C10375**  
26 cm - 10 1/4"

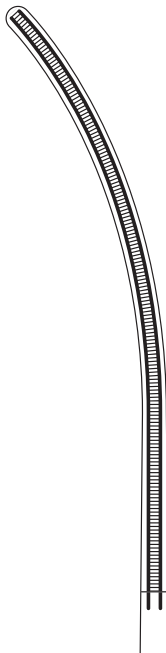
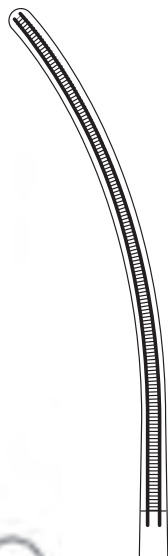

**C10380**  
27 cm - 10 1/2"

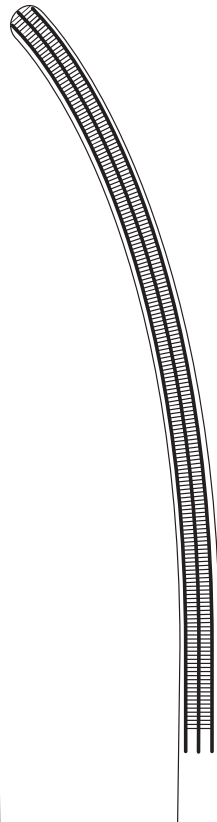

**C10385**  
31 cm - 12 1/4"

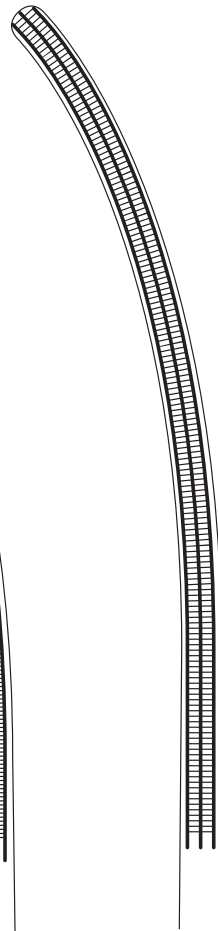

**C10390**  
33 cm - 13"

V - Clamps  
V - Clamps  
V - Clamps

**V-7**

# LANDANGER

Pinces clamps cardiovasculaires atrauma - Atrauma cardiovascular forceps - Pinzas clamps cardiovasculares atrauma

1/3



Mors DeBakey  
DeBakey Jaws  
Boca DeBakey

## DEBAKEY

Pour anévrisme de l'aorte  
For aortic aneurysm  
Para aneurisma de la aorta



**C10400**  
30 cm - 11 <sup>3</sup>/<sub>4</sub> "

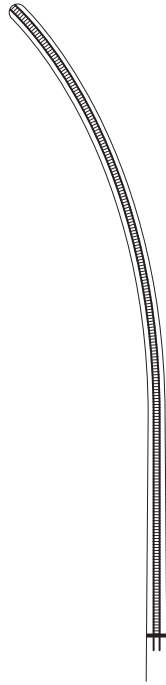

**C10395**  
28 cm - 11 "

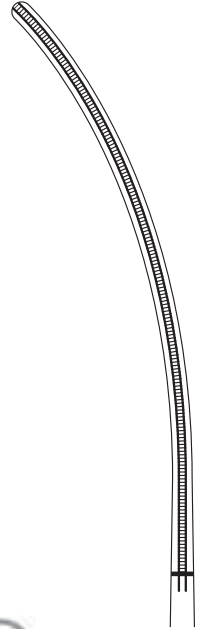

## OCHSNER

Pour l'aorte  
For aortic  
Para la aorta



**C10742**  
23,5 cm - 9 <sup>1</sup>/<sub>4</sub> "

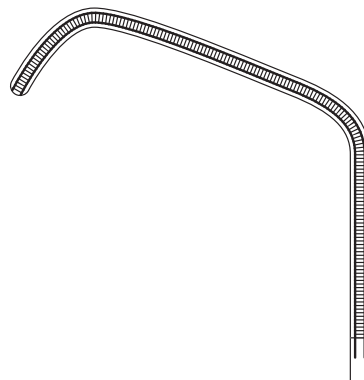

V - Clamps  
V - Clamps  
V - Clamps

**V - 8**



# LANDANGER

Pinces clamps cardiovasculaires atrauma - Atrauma cardiovascular forceps - Pinzas clamps cardiovasculares atrauma



## DIETRICH

Pour l'aorte  
For aortic  
Para la aorta



**C10744**

23,5 cm - 9 1/4 "

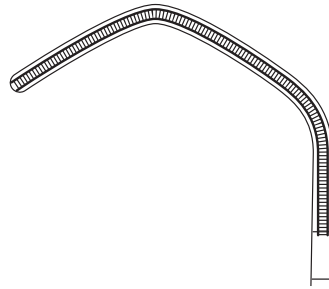

## HARKEN

Pour oreillette  
Auricle clamps  
Pinzas-clamps auriculares

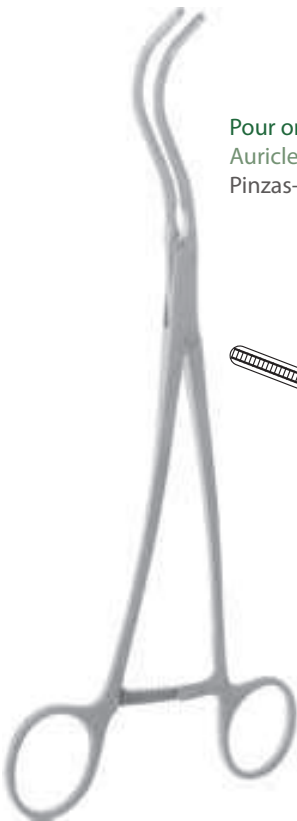

**C10500**

24 cm - 9 1/2 "

**C10495**

24 cm - 9 1/2 "

**C10490**

24 cm - 9 1/2 "

**C10485**

24 cm - 9 1/2 "

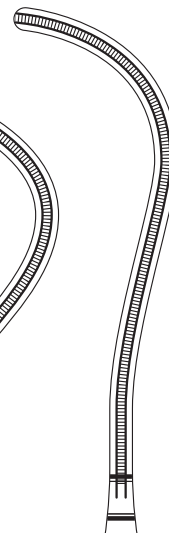
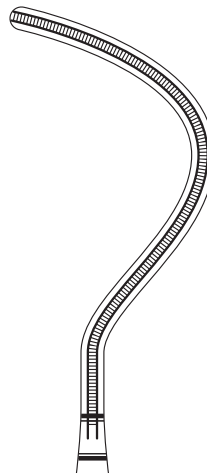
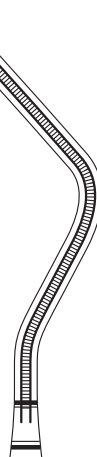

V - Clamps  
V - Clamps  
V - Clamps

# LANDANGER

Pinces clamps cardiovasculaires atrauma - Atrauma cardiovascular forceps - Pinzas clamps cardiovasculares atrauma

1/2

LEES



Pour les bronches  
For bronchus  
Para los bronquios

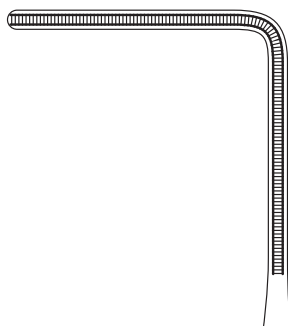

**C10505**  
23 cm - 9"

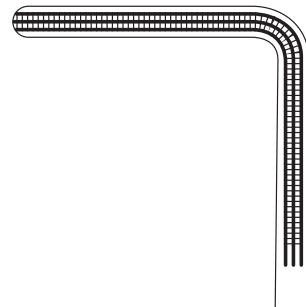

**C10510**  
25 cm - 10"

V - Clamps  
V - Clamps  
V - Clamps

Pour les bronches  
For bronchus  
Para los bronquios



**C10515**  
25 cm - 10"

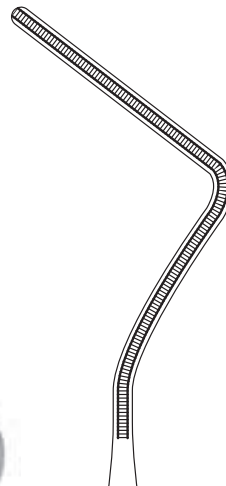

**V - 10**

# LANDANGER

Pinces clamps cardiovasculaires atrauma - Atrauma cardiovascular forceps - Pinzas clamps cardiovasculares atrauma



Mors DeBaKey  
DeBaKey Jaws  
Boca DeBaKey



DEBAKEY

Pour l'aorte  
For aortic  
Para la aorta



**C10405**  
27 cm - 10 1/2"

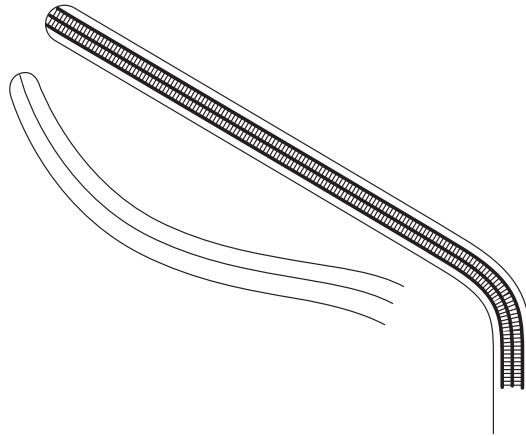

Pour ligature  
For ligature  
Para ligadura

**C10415**  
24 cm - 9 1/2"

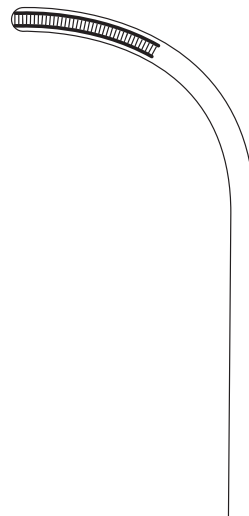

Pour l'aorte  
For aortic  
Para la aorta

**C10410**  
24 cm - 9 1/2"

V - Clamps  
V - Clamps  
V - Clamps

# LANDANGER

Pinces clamps cardiovasculaires atrauma - Atrauma cardiovascular forceps - Pinzas clamps cardiovasculares atrauma



## DEBAKEY



Pour ligature  
For ligature  
Para ligadura

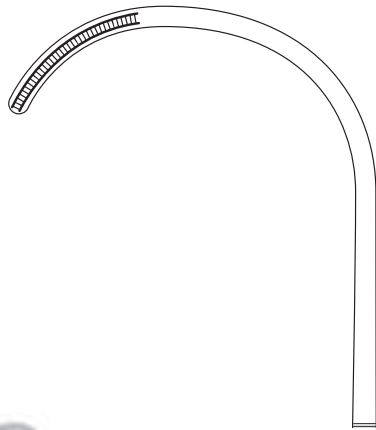

**C10420**  
25 cm - 10 "

Pour l'aorte  
For aortic  
Para la aorta

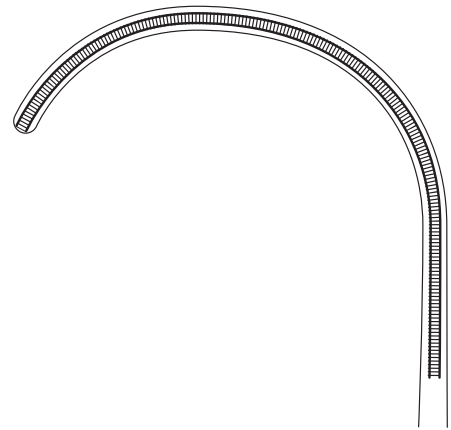

**C10425**  
26 cm - 10 1/4 "

## WEBER



A droite  
On the Right  
A la derecha



**C10430**  
26 cm - 10 1/4 "

Pour l'aorte  
For aortic  
Para la aorta

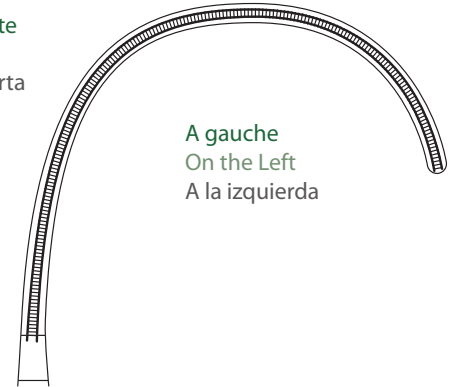

A gauche  
On the Left  
A la izquierda

**C10435**  
26 cm - 10 1/4 "

V - Clamps  
V - Clamps  
V - Clamps

**V - 12**

# LANDANGER

Pinces clamps cardiovasculaires atrauma - Atrauma cardiovascular forceps - Pinzas clamps cardiovasculares atrauma



## SATINSKY

Pour occlusion tangentielle  
For tangential occlusion  
Para oclusión tangencial

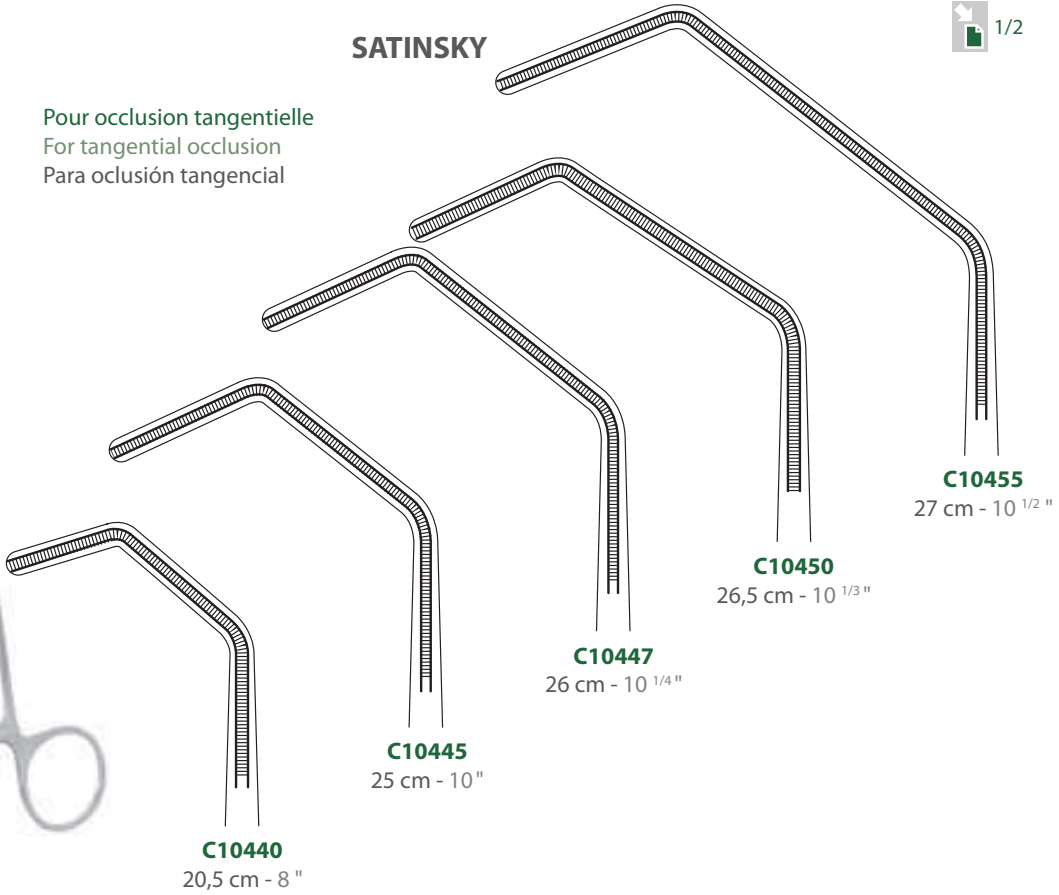

**C10440**  
20,5 cm - 8 "

**C10445**  
25 cm - 10 "

**C10447**  
26 cm - 10 1/4 "

**C10450**  
26,5 cm - 10 1/3 "

**C10455**  
27 cm - 10 1/2 "

## LAMBERT KAY

Pour anastomose de l'aorte  
For aortic anastomosis  
Para anastomosis de la aorta

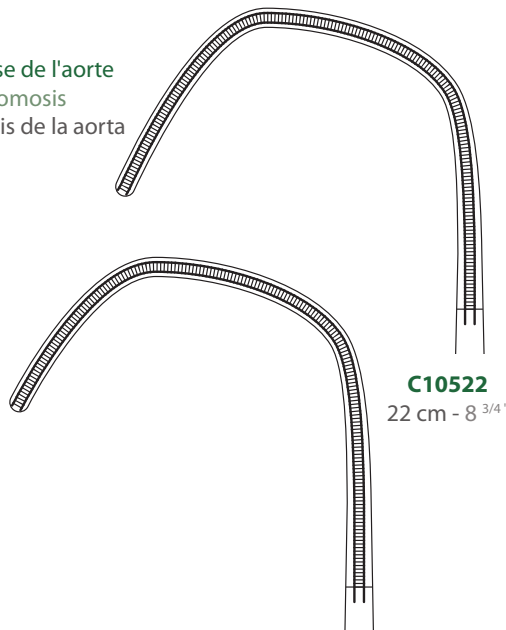

**C10520**  
20 cm - 8 "

**C10522**  
22 cm - 8 3/4 "

## DEBAKEY

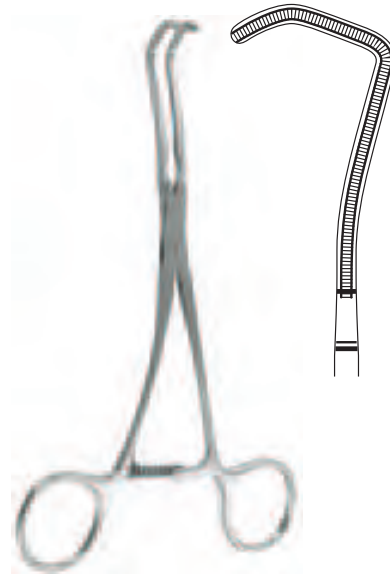

**C10525**  
17 cm - 6 3/4 "

V - Clamps  
V - Clamps  
V - Clamps

# LANDANGER

Pinces clamps cardiovasculaires atrauma - Atrauma cardiovascular forceps - Pinzas clamps cardiovasculares atrauma



## BECK

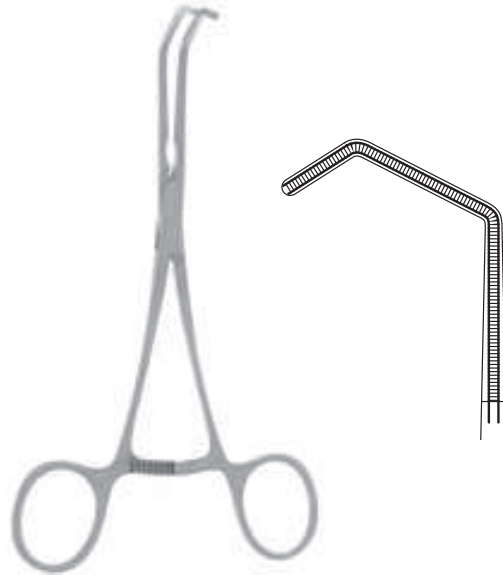

**C10715**  
17 cm - 6 3/4"

## DEBAKEY

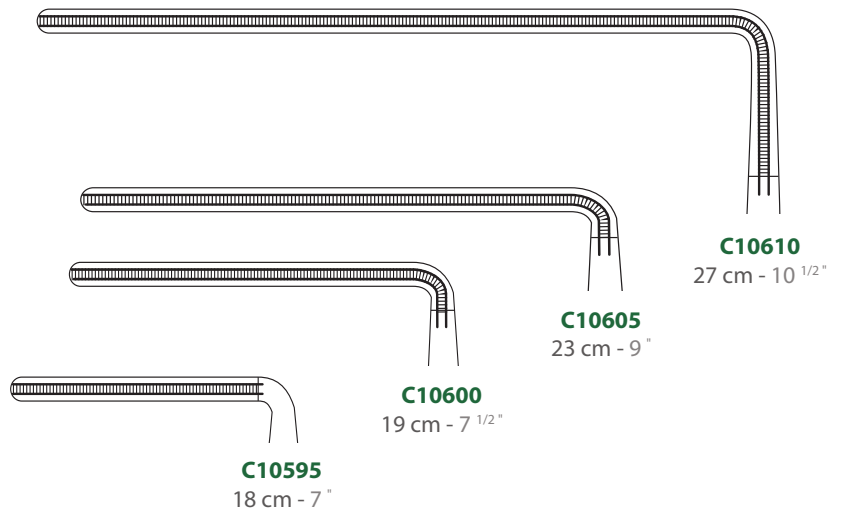

**C10595**  
18 cm - 7"

**C10600**  
19 cm - 7 1/2"

**C10605**  
23 cm - 9"

**C10610**  
27 cm - 10 1/2"

V - Clamps  
V - Clamps  
V - Clamps

V - 14

# LANDANGER

Pinces clamps cardiovasculaires atrauma - Atrauma cardiovascular forceps - Pinzas clamps cardiovasculares atrauma



## DEBAKEY

A usages multiples  
For multi purpose  
Para usos varios

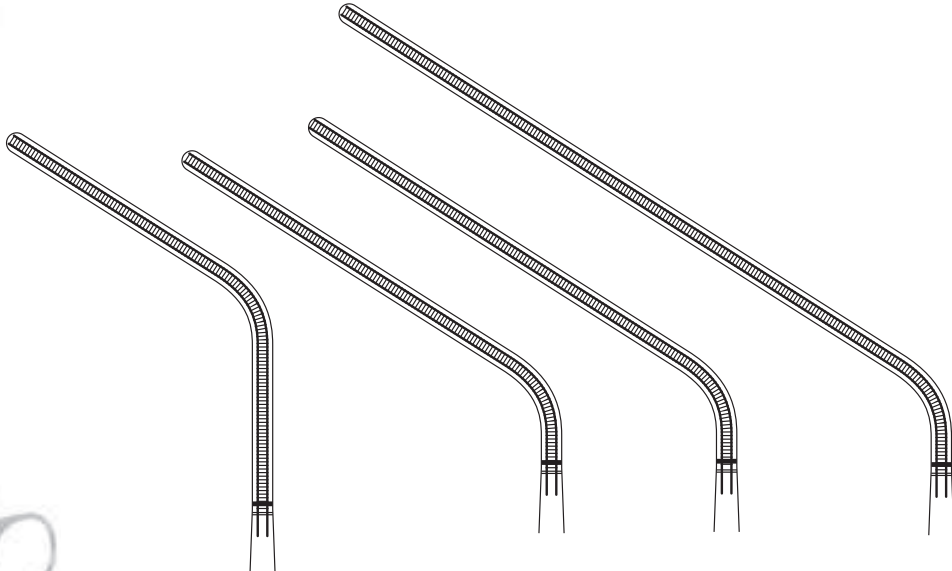

**C10615**  
25 cm - 10"

**C10620**  
21 cm - 8 1/4"

**C10625**  
25 cm - 10"

**C10630**  
29 cm - 11 1/2"

## MORRIS DEBAKEY

Pour l'aorte  
For aortic  
Para la aorta

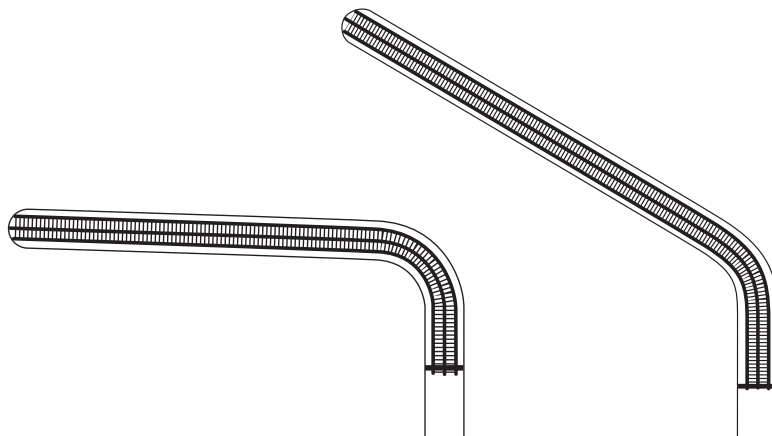

**C10528**  
18 cm - 7"

**C10532**  
23 cm - 9"

**C10530**  
20 cm - 8"

**C10535**  
25 cm - 10"

V - Clamps  
V - Clamps  
V - Clamps

# LANDANGER

Pinces clamps cardiovasculaires atrauma - Atrauma cardiovascular forceps - Pinzas clamps cardiovasculares atrauma

1/2

## DEBAKEY BAHNSON



Pour anévrisme de l'artère iliaque  
For iliac artery aneurysm  
Para aneurisma de la arteria iliaca

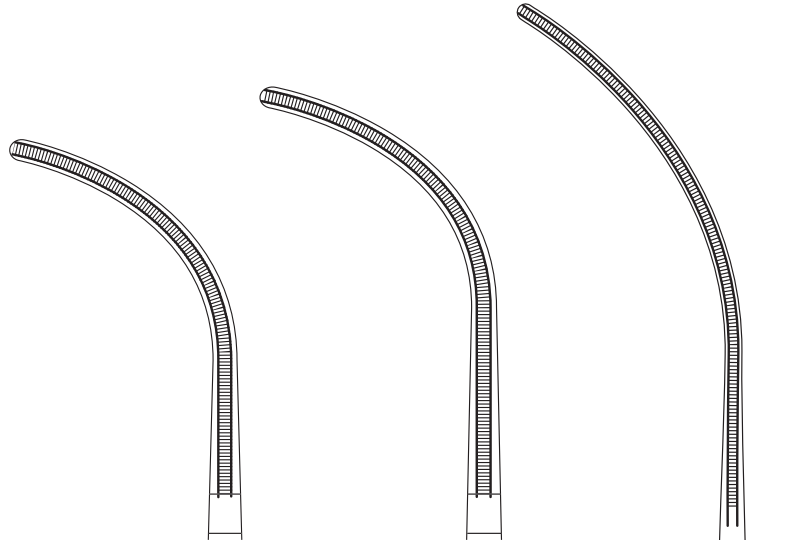

**C10540**  
26 cm - 10 <sup>1</sup>/<sub>4</sub>"

**C10545**  
26,5 cm - 10 <sup>1</sup>/<sub>3</sub>"

**C10550**  
28,5 cm - 11 <sup>1</sup>/<sub>4</sub>"

V - Clamps  
V - Clamps  
V - Clamps

Pour coarctation  
For coarctation  
Para coarctación

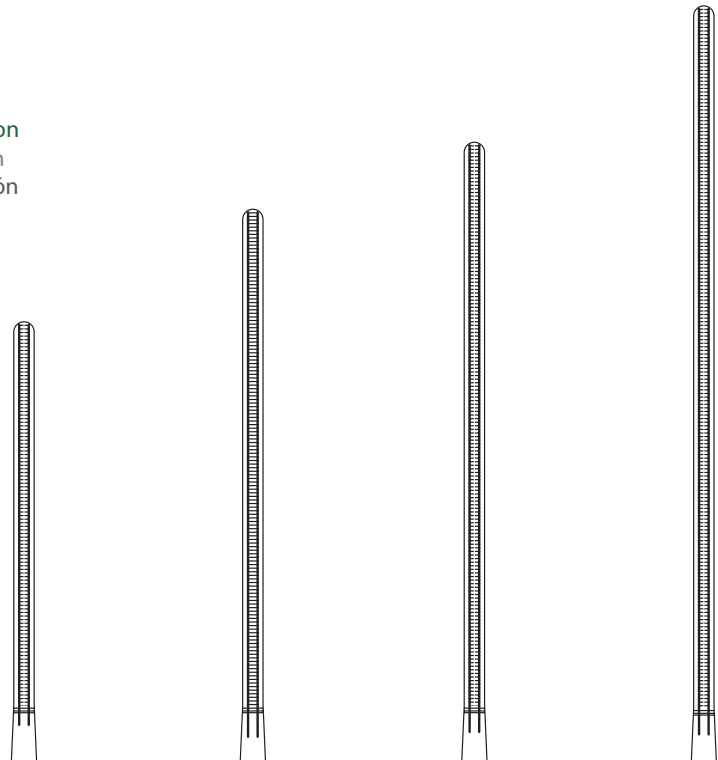

**C10555**  
21,5 cm - 8 <sup>1</sup>/<sub>2</sub>"

**C10560**  
23 cm - 9"

**C10565**  
27 cm - 10 <sup>1</sup>/<sub>2</sub>"

**C10570**  
31,5 cm - 12 <sup>1</sup>/<sub>2</sub>"

**V - 16**



# LANDANGER

## Pinces clamps cardiovasculaires atrauma - Atrauma cardiovascular forceps - Pinzas clamps cardiovasculares atrauma



Pour coarctation  
For coarctation  
Para coarctación

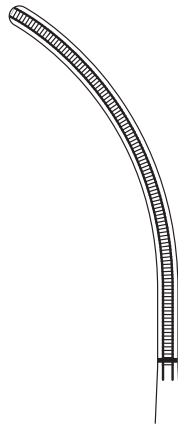

**C10575**  
19,5 cm - 7 <sup>3</sup>/<sub>4</sub> "

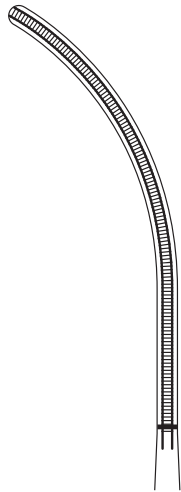

**C10580**  
23 cm - 9 "

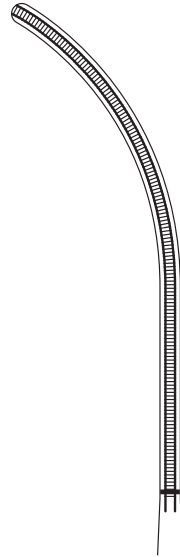

**C10585**  
25,5 cm - 10 <sup>1</sup>/<sub>4</sub> "

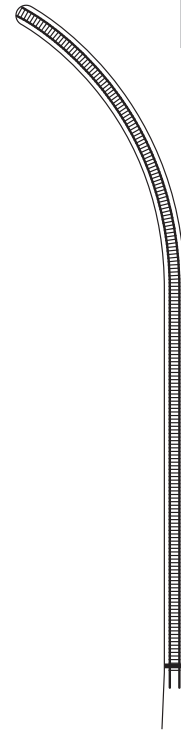

**C10590**  
31 cm - 12 <sup>1</sup>/<sub>4</sub> "

### DEBAKEY PEAN

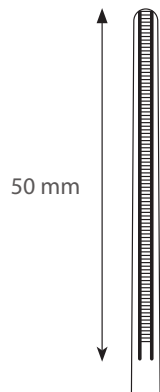

**C10640**  
14 cm - 5 <sup>1</sup>/<sub>2</sub> "  
38 mm

**C10641**  
16 cm - 6 <sup>1</sup>/<sub>4</sub> "  
44 mm

**C10642**  
18 cm - 7 "  
48 mm

**C10643**  
20 cm - 8 "  
50 mm\*

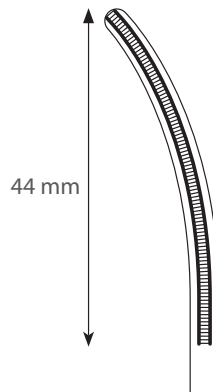

**C10650**  
14 cm - 5 <sup>1</sup>/<sub>2</sub> "  
38 mm

**C10651**  
16 cm - 6 <sup>1</sup>/<sub>4</sub> "  
44 mm

**C10652**  
18 cm - 7 "  
44 mm

**C10653**  
20 cm - 8 "  
44 mm

V - Clamps  
V - Clamps  
V - Clamps

# LANDANGER

Pinces clamps cardiovasculaires atrauma - Atrauma cardiovascular forceps - Pinzas clamps cardiovasculares atrauma



## DEBAKEY RANKIN

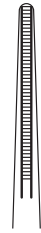

**C10631**  
16 cm - 6 1/4"



**C10632**  
16 cm - 6 1/4"

## DEBAKEY MOSQUITO



**C10635**  
12 cm - 4 3/4"

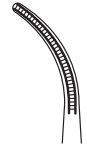

**C10645**  
12 cm - 4 3/4"



**C10633**  
15 cm - 6"

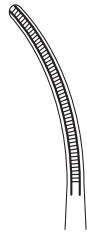

**C10634**  
15 cm - 6"



## DEBAKEY

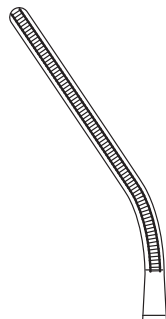

**C10660**  
16 cm - 6 1/4"

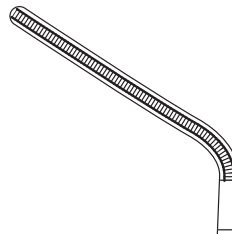

**C10665**  
15 cm - 6"

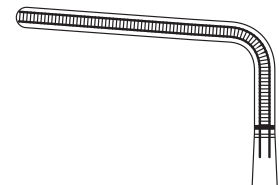

**C10670**  
14,5 cm - 5 3/4"

V - Clamps  
V - Clamps  
V - Clamps

V - 18

# LANDANGER

Pinces clamps cardiovasculaires atrauma - Atrauma cardiovascular forceps - Pinzas clamps cardiovasculares atrauma



## DEBAKEY



**C10655**  
17 cm - 6 <sup>3</sup>/<sub>4</sub>''



**C10675**  
17 cm - 6 <sup>3</sup>/<sub>4</sub>''

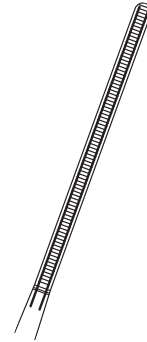

## GLOVER



**C10680**  
17 cm - 6 <sup>3</sup>/<sub>4</sub>''

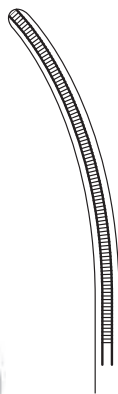

**C10685**  
17 cm - 6 <sup>3</sup>/<sub>4</sub>''

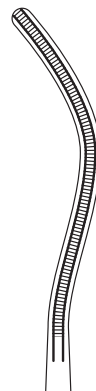

V - Clamps  
V - Clamps  
V - Clamps

# LANDANGER

Pinces clamps cardiovasculaires atrauma - Atrauma cardiovascular forceps - Pinzas clamps cardiovasculares atrauma

1/2

## GLOVER



Pour ligature  
For ligature  
Para ligadura

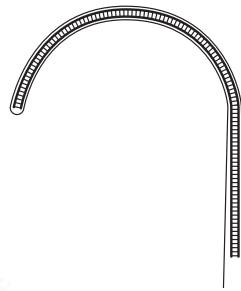

**C10690**  
16 cm - 6 1/2"

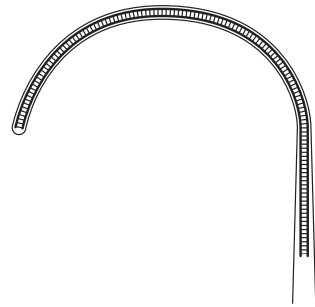

**C10695**  
17 cm - 6 1/4"

## DERRA

Pour l'anastomose  
For anastomosis  
Para anastomosis

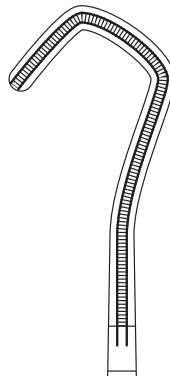

**C10700**  
16 cm - 6 1/4"

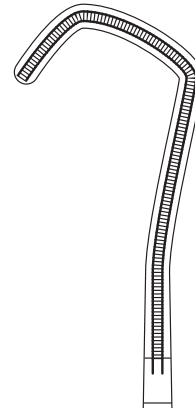

**C10705**  
17 cm - 6 3/4"

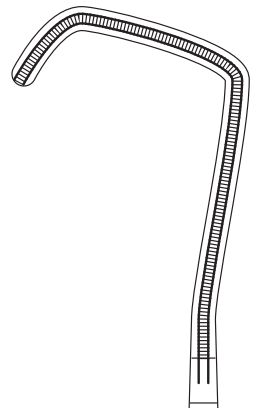

**C10710**  
18 cm - 7"

V - Clamps  
V - Clamps  
V - Clamps

**V - 20**

# LANDANGER

Pinces clamps cardiovasculaires atrauma - Atrauma cardiovascular forceps - Pinzas clamps cardiovasculares atrauma



Mors DeBaKey  
DeBaKey Jaws  
Boca DeBaKey

DALE



Pinces-clamps périphériques  
Peripheral vessel clamps  
Pinzas clamps perifericas



**C10746**  
18,5 cm - 7<sup>1</sup>/<sub>4</sub>"

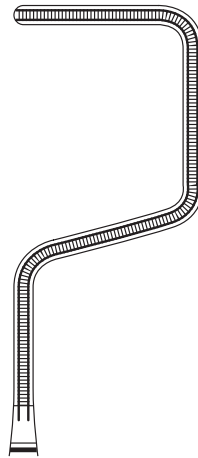

**C10748**  
17 cm - 6<sup>3</sup>/<sub>4</sub>"

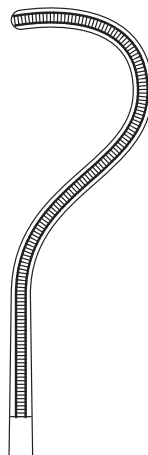
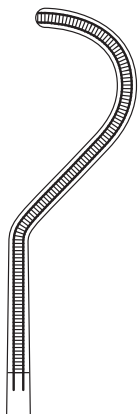

**C10749**  
17,5 cm - 6<sup>4</sup>/<sub>5</sub>"

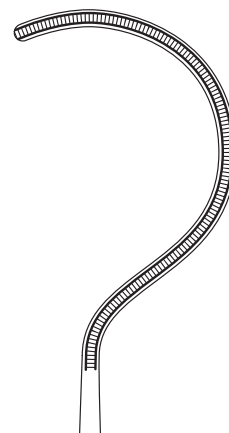

**C10751**  
18,5 cm - 7<sup>1</sup>/<sub>4</sub>"

V - Clamps  
V - Clamps  
V - Clamps

# LANDANGER

Pinces clamps cardiovasculaires atrauma - Atrauma cardiovascular forceps - Pinzas clamps cardiovasculares atrauma



## GREGORY



Pour la profondeur  
Profunda clamps  
Para la profundidad

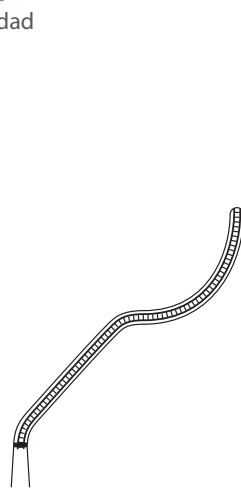

**C10753**  
14,5 cm - 5<sup>3/4</sup>"

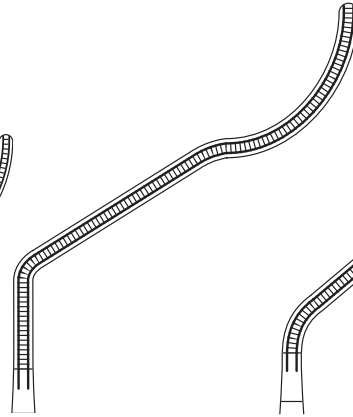

**C10754**  
18,5 cm - 7<sup>1/4</sup>"

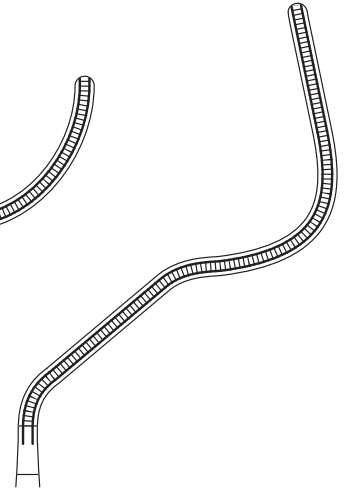

**C10756**  
19,5 cm - 7<sup>3/4</sup>"

V - Clamps  
V - Clamps  
V - Clamps

## SUBRAMANIAN

Pour l'aorte  
For aortic  
Para la aorta

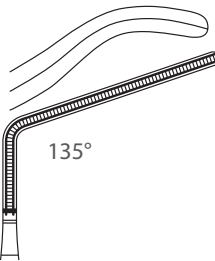

**C11005**  
15,5 cm - 6"

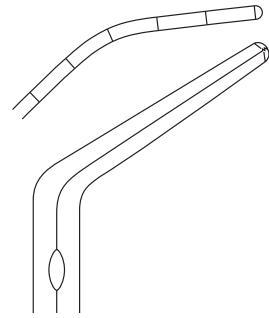

**C11010**  
16 cm - 6<sup>1/4</sup>"

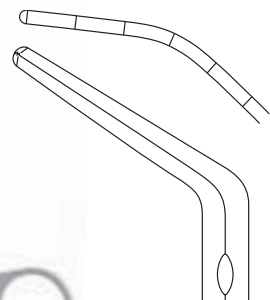
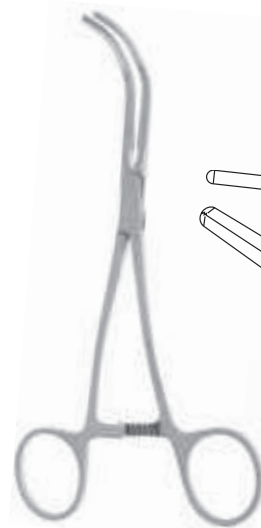

**C11015**  
16 cm - 6<sup>1/4</sup>"

**V - 22**

# LANDANGER

Pinces clamps cardiovasculaires atrauma - Atrauma cardiovascular forceps - Pinzas clamps cardiovasculares atrauma



## DEBAKEY



**C10730**  
12 cm - 4 3/4"



**C10725**  
10 cm - 4"

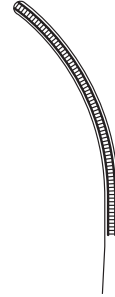

**C10720**  
11 cm - 4 1/4"

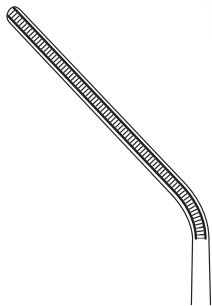

**C10740**  
13 cm - 5"



**C10735**  
12 cm - 4 3/4"

V - Clamps  
V - Clamps  
V - Clamps

# LANDANGER

Pinces clamps cardiovasculaires atrauma - Atrauma cardiovascular forceps - Pinzas clamps cardiovasculares atrauma



## JAVID

Pour la carotide  
For carotid  
Para la carotida

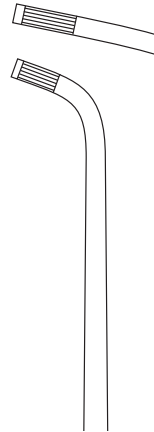

**C10772**  
16 cm - 6 1/4"



**C10774**  
19 cm - 7 1/2"

V - Clamps  
V - Clamps  
V - Clamps



Mors Cooley  
Cooley Jaws  
Boca Cooley

## COOLEY

A usages multiples  
For multi-purpose  
Para usos varios

Pour la coarctation  
For coarctation  
Para la coarctación



**C10800**  
17 cm - 6 3/4"

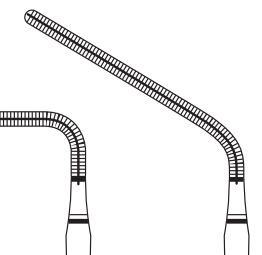

**C10790**  
13,5 cm - 5 1/4"

**C10795**  
15,5 cm - 6 1/8"

**V - 24**



# LANDANGER

Pinces clamps cardiovasculaires atrauma - Atrauma cardiovascular forceps - Pinzas clamps cardiovasculares atrauma



## COOLEY



Pour la coarctation  
For coarctation  
Para la coarctación

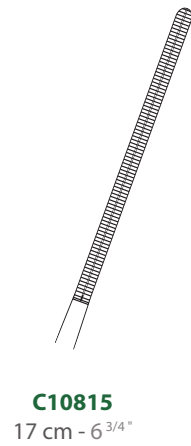
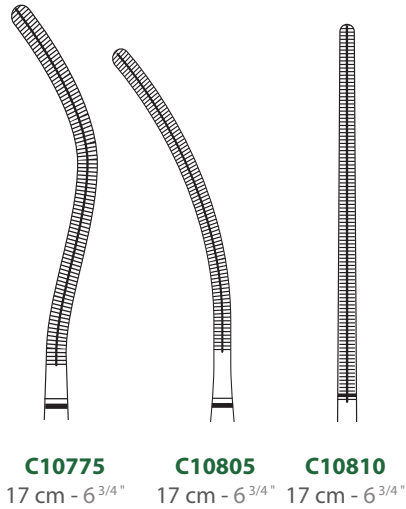

Pour ligature  
For ligature  
Para ligadura



Pour anastomose  
For anastomosis  
Para anastomosis

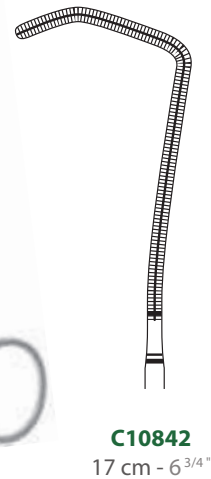

V - Clamps  
V - Clamps  
V - Clamps

# LANDANGER

## Pinces clamps cardiovasculaires atrauma - Atrauma cardiovascular forceps - Pinzas clamps cardiovasculares atrauma



### COOLEY



Mors Cooley  
Cooley Jaws  
Boca Cooley



Pour anastomose  
For anastomosis  
Para anastomosis

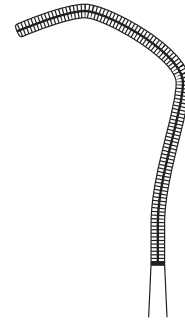

**C10845**  
16 cm - 6 1/4"

## Pinces clamps nouveau né et pédiatrique - Neonatal and pediatric clamps - Pinzas clamps para recién nacidos y pediátrico

V - Clamps  
V - Clamps  
V - Clamps



Mors Cooley  
Cooley Jaws  
Boca Cooley

### COOLEY



**C11020**  
14 cm - 5 1/2"

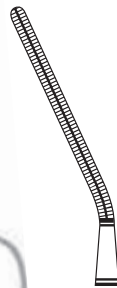
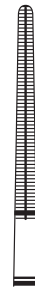

**C11025**  
14 cm - 5 1/2"



**C11030**  
14 cm - 5 1/2"

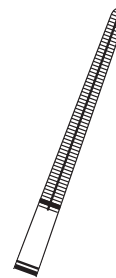

**C11040**  
14 cm - 5 1/2"

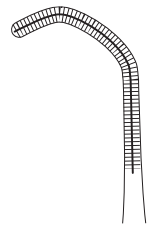

**C11035**  
14 cm - 5 1/2"

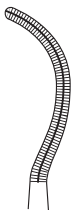

# LANDANGER

Pinces clamps nouveau né et pédiatrique - Neonatal and pediatric clamps - Pinzas clamps para recién nacidos y pediátrico



## COOLEY

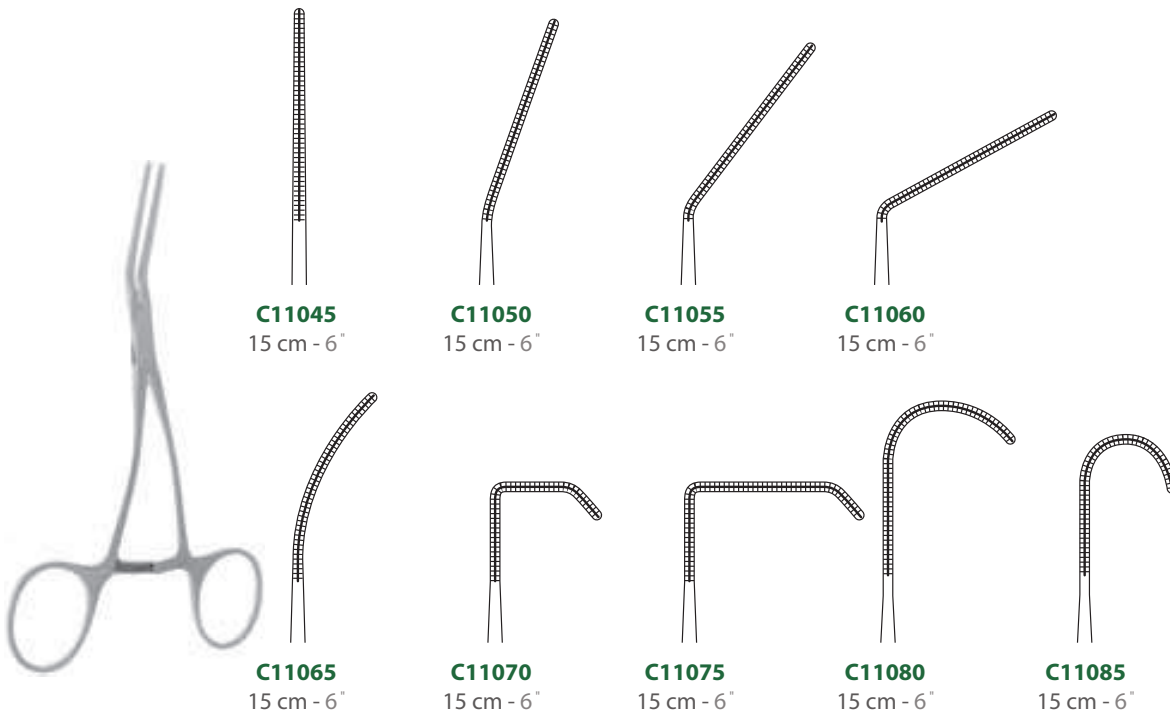

V - Clamps  
V - Clamps  
V - Clamps

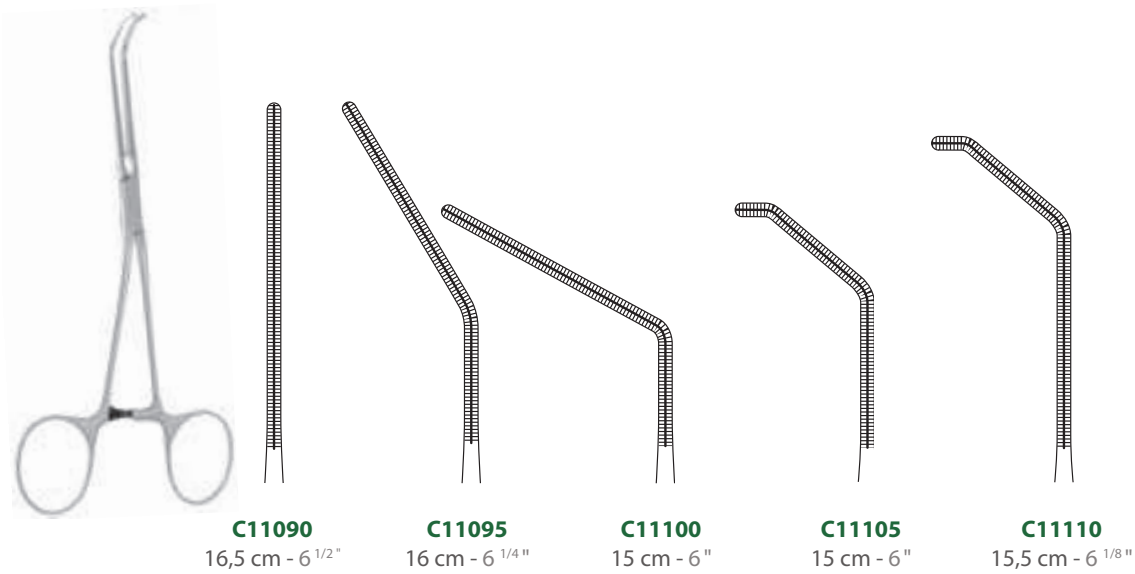

# LANDANGER

Pinces clamps nouveau né et pédiatrique - Neonatal and pediatric clamps - Pinzas clamps para recién nacidos y pediátrico

1/1

## CASTANEDA

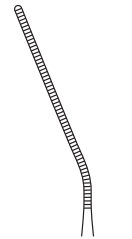

**C11115**  
12 cm - 4 <sup>3</sup>/<sub>4</sub> "

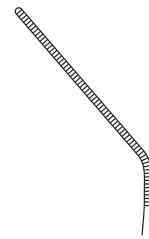

**C11120**  
11,5 cm - 4 <sup>1</sup>/<sub>2</sub> "



**C11125**  
10 cm - 4 "

V - Clamps  
V - Clamps  
V - Clamps

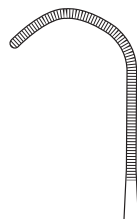

**C11130**  
11,5 cm - 4 <sup>1</sup>/<sub>2</sub> "



**C11135**  
11,5 cm - 4 <sup>1</sup>/<sub>2</sub> "

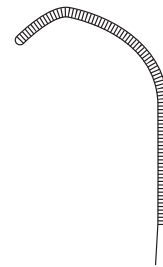

**C11140**  
12 cm - 4 <sup>3</sup>/<sub>4</sub> "

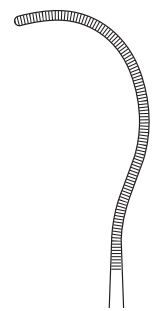

**C11145**  
12 cm - 4 <sup>3</sup>/<sub>4</sub> "

**V - 28**

## Dr. MULLER



Crochets à phlebotomie  
Phlebotomy hooks  
Ganchos para flebectomía



**C010106**  
N° 1  
14,5 cm - 5 3/4 "



**C010206**  
N° 2  
15 cm - 6 "



**C010306**  
N° 3  
15,5 cm - 6 1/8 "



**C010406**  
N° 4  
16 cm - 6 1/4 "



**C010106**

## RUMEL BELMONT

Tourniquet vasculaire  
Vascular tourniquet  
Tourniquete vascular



**C09150**  
32 cm - 12 1/2 "



Mandrin seul  
Single pad  
Mandril único



**C091510**  
28 cm - 11 "

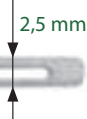

V - Clamps  
V - Clamps  
V - Clamps

# LANDANGER

---

V - Clamps  
V - Clamps  
V - Clamps

Instruments à sutures - Suture instruments - Instrumentos de sutura

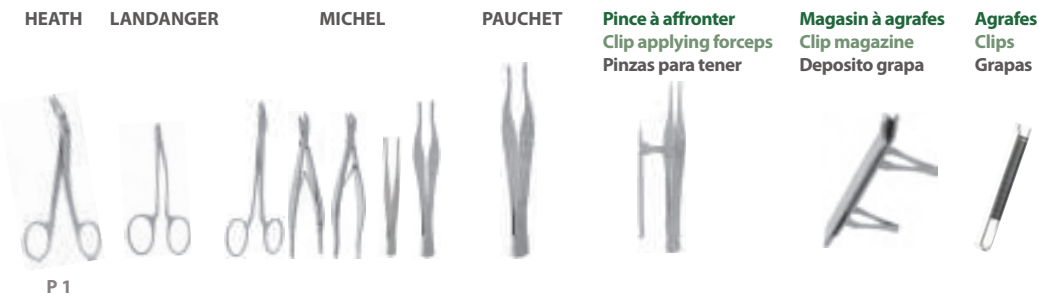

Porte-aiguilles - Needle holders - Porta agujas

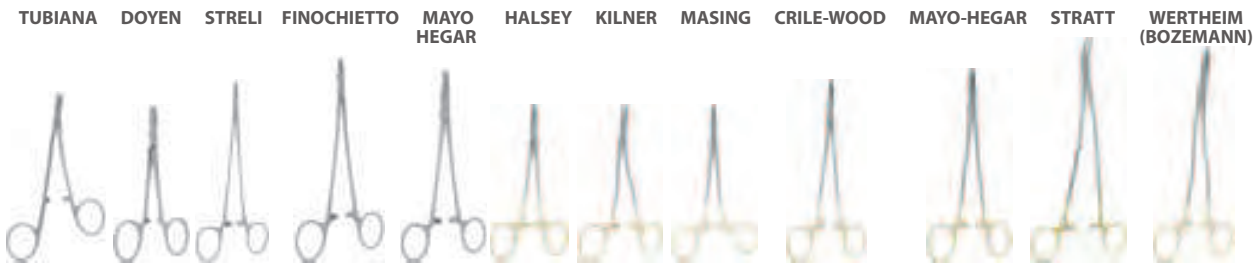

Porte-aiguilles Vasculaire - Needle holders Vascular - Porta agujas Vascular

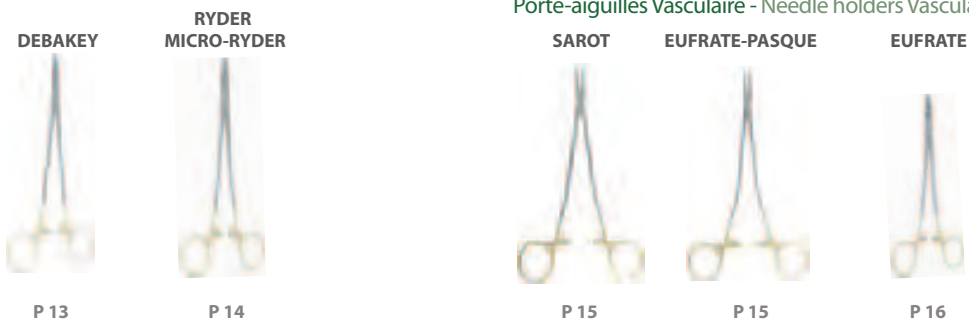

Porte-aiguilles coupe fil - Needle holders wire cutting - Porta agujas cortar ligaduras



Pinces à fils - Wire forceps - Pinza alambre



Aiguilles à suture - Suture needles  
Agujas de sutura

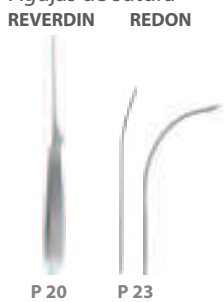

Aiguilles à ligature - Ligature needles - Agujas para ligaduras

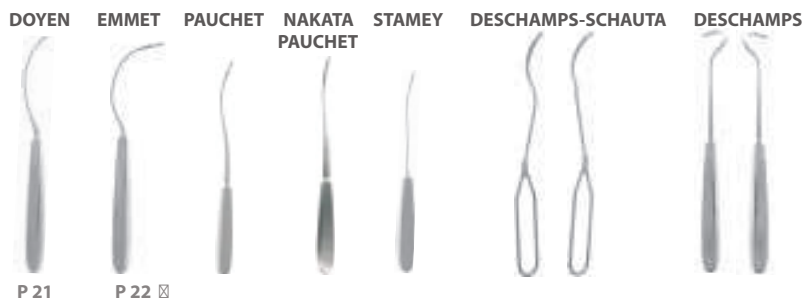

X - Microchirurgie  
X - Microsurgery  
X - Microcirugía

Microchirurgie porte-aiguilles - Microsurgery needle holders - Microcirugía porta-agujas

CASTROVIEJO



P 1

P 2

JACOBSON



P 3

BARRAQUER



P 4

YASARGIL



P 5

XV - Divers  
XV - Miscellaneous  
XV - Diversos

Service - Services - Servicio

MAYO-HÉGAR



P 13

CRILE-WOOD



P 13

Accessoires - Accessories - Accesorios

MAYO



P 28

LORTAT-JACOB



P 29

LANDANGER



P 29



# LANDANGER

Instruments à sutures - Suture instruments - Instrumentos de sutura

HEATH

LANDANGER



Pinces à retirer les agrafes  
Clip removing forceps  
Pinzas para retirar las grapas



**G25060**  
14 cm - 5 1/2"



**G25061 (Affinée)**  
14 cm - 5 1/2 "



**G25062**  
11 cm - 4 1/4"

VI - Sutures  
VI - Sutures  
VI - Sutura

**VI - 1**

# LANDANGER

Instruments à sutures - Suture instruments - Instrumentos de sutura

1/1

## MICHEL

Pinces à retirer les agrafes  
Clip removing forceps  
Pinzas para retirar las grapas

Double usage  
Applying and removing  
Uso doble



A doigts  
Collin's lock  
Desmontables

**G25050**  
13 cm - 5 "



A doigts  
Collin's lock  
Desmontables

**G25080**  
12 cm - 4 <sup>3</sup>/<sub>4</sub>"



**G25070**  
12 cm - 4 <sup>3</sup>/<sub>4</sub>"

VI - Sutures  
VI - Sutures  
VI - Sutura

**VI - 2**

# LANDANGER

Instruments à sutures - Suture instruments - Instrumentos de sutura



**MICHEL**

**PAUCHET**

**WACHENFELDT**

Pinces à affronter avec magasin fixe  
Clip applying forceps with fixed magazine  
Pinzas para tener con deposito fijo

Pinces à poser les agrafes  
Clip applying forceps  
Pinzas para poner las grapas

Pour agrafes  
For clips  
Para grapas

7,5 mm - 9/32" **G25135**

12 mm - 15/32" **G25140**

14 mm - 9/16" **G25150**

16 mm - 5/8" **G25160**

Pour agrafes 7,5 mm  
For clips 7,5 mm  
Para grapas 7,5 mm



**G25010**  
10 cm - 4"



**G25020**  
13 cm - 5"



**G25030**  
16 cm - 6 1/4"



**G25040**  
12 cm - 4 3/4"



**G25135**  
14 cm - 5 1/2"

VI - Sutures  
VI - Sutures  
VI - Sutura

# LANDANGER

## Instruments à sutures - Suture instruments - Instrumentos de sutura

Pour agrafes  
For clips  
Para grapas

12 mm	<b>G252601</b>
14 mm	<b>G252701</b>
16 mm	<b>G252801</b>

Boite de 100  
Box of 100  
Caja de 100

7,5 mm	<b>G25390</b>
12 mm	<b>G25400</b>
14 mm	<b>G25410</b>
16 mm	<b>G25420</b>
18 mm	<b>G25430</b>
20 mm	<b>G25440</b>

Magasin à agrafes à clip  
Clip magazine  
Deposito clip



**G252601**  
9 cm - 3 1/2 "

Agrafes de Michel "Perfect"  
Michel's "Perfect" clip  
Grapas de Michel "Perfect"



**G25390**  
7,5 mm

# LANDANGER

Porte-aiguilles - Needle holders - Porta agujas



TUBIANA

DOYEN

STRELI



**G300050**  
14 cm - 5 1/2 "



A doigt  
Collin's lock  
Desmontable

**G30010**  
13 cm - 5 "

Branches passées  
Box lock  
Indesmontable

**G300150**  
13 cm - 5 "



**G30080**  
15 cm - 6 "

VI - Sutures  
VI - Sutures  
VI - Sutura

**VI - 5**

# LANDANGER

Porte-aiguilles - Needle holders - Porta agujas



## FINOCHIETTO



VI - Sutures  
VI - Sutures  
VI - Sutura

**VI - 6**

# LANDANGER

Porte-aiguilles - Needle holders- Porta agujas



## MAYO-HEGAR



**G30082**  
14 cm - 5 1/2"



**G30084**  
16 cm - 6 1/4"



**G30086**  
18 cm - 7 "  
**G30088**  
20 cm - 8 "

VI - Sutures  
VI - Sutures  
VI - Sutura

# LANDANGER

Porte-aiguilles - Needle holders - Porta agujas

1/1



**HALSEY**

**KILNER**

**MASING**



**VI - 8**



# LANDANGER

Porte-aiguilles - Needle holders - Porta agujas



## BABY CRILE-WOOD

15 cm - 6 " **G300950**



**G300950**  
15 cm - 6 "

## CRILE-WOOD

- 13 cm - 5 " **G30090**
- 15 cm - 6 " **G30100**
- 18 cm - 7 " **G30110**
- 20 cm - 8 " **G30120**
- 23 cm - 9 " **G30130**
- 26 cm - 10 <sup>1</sup>/<sub>4</sub> " **G30140**
- 30 cm - 11 <sup>3</sup>/<sub>4</sub> " **G30150**



**G30090**  
13 cm - 5 "



**G30100**  
15 cm - 6 "



**G30130**  
23 cm - 9 "



**G30110**  
18 cm - 7 "



**G30140**  
26 cm - 10 <sup>1</sup>/<sub>4</sub> "



**G30120**  
20 cm - 8 "



**G30150**  
30 cm - 11 <sup>3</sup>/<sub>4</sub> "

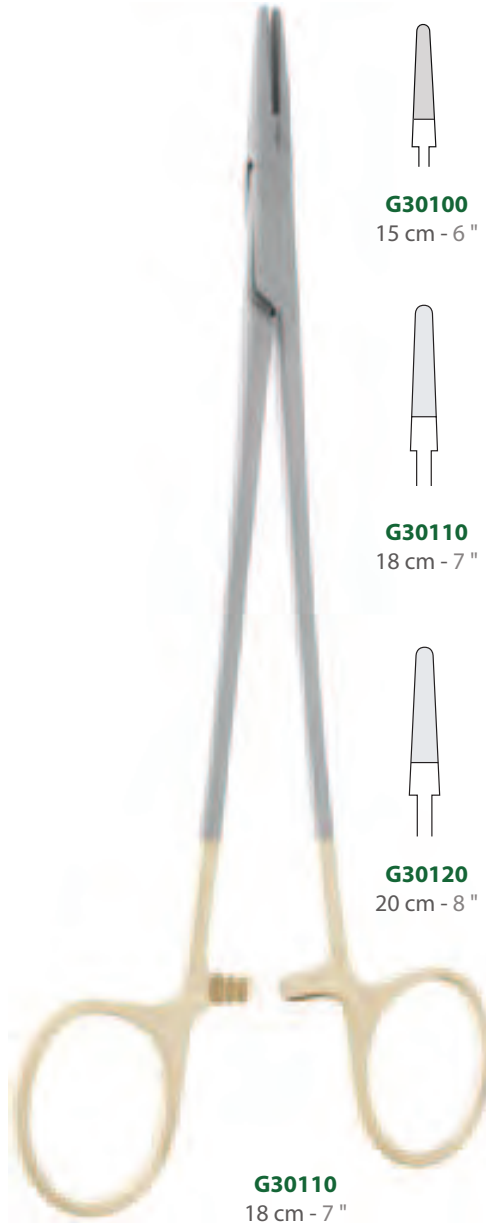

**G30110**  
18 cm - 7 "

VI - Sutures  
VI - Sutures  
VI - Sutura

# LANDANGER

Porte-aiguilles - Needle holders - Porta agujas



## MAYO-HEGAR

Droit  
Straight  
Recta

14 cm - 5 1/2 "	<b>G30210</b>
16 cm - 6 1/4 "	<b>G30220</b>
18 cm - 7 "	<b>G30230</b>
20 cm - 8 "	<b>G30240</b>
23 cm - 9 "	<b>G30250</b>
26 cm - 10 1/4 "	<b>G30260</b>
30 cm - 11 3/4 "	<b>G30270</b>

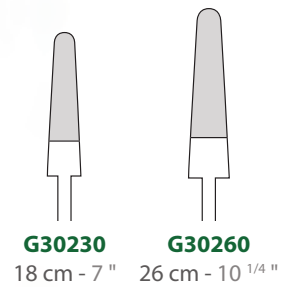
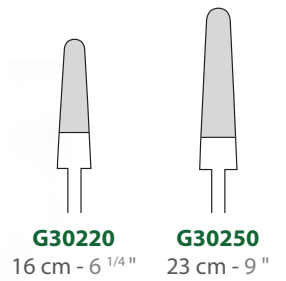
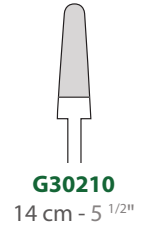

**G30220**  
16 cm - 6 1/4 "

**G30230**  
18 cm - 7 "

VI - Sutures  
VI - Sutures  
VI - Sutura

**VI - 10**



## MAYO-HEGAR

Courbe  
Curved  
Curva

18 cm - 7 "	<b>G30280</b>
20 cm - 8 "	<b>G30290</b>
23 cm - 9 "	<b>G30300</b>
26 cm - 10 <sup>1</sup> / <sub>4</sub> "	<b>G30310</b>



**G30280**  
18 cm - 7 "

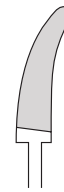

**G30280**  
18 cm - 7 "

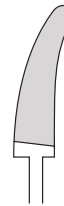

**G30290**  
20 cm - 8 "

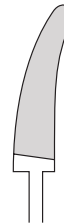

**G30300**  
23 cm - 9 "

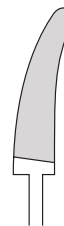

**G30310**  
26 cm - 10 <sup>1</sup>/<sub>4</sub> "

VI - Sutures  
VI - Sutures  
VI - Sutura

# LANDANGER

Porte-aiguilles - Needle holders - Porta agujas



**STRATT**

**WERTHEIM  
(BOZEMANN)**



**G30370**  
23 cm - 9 "

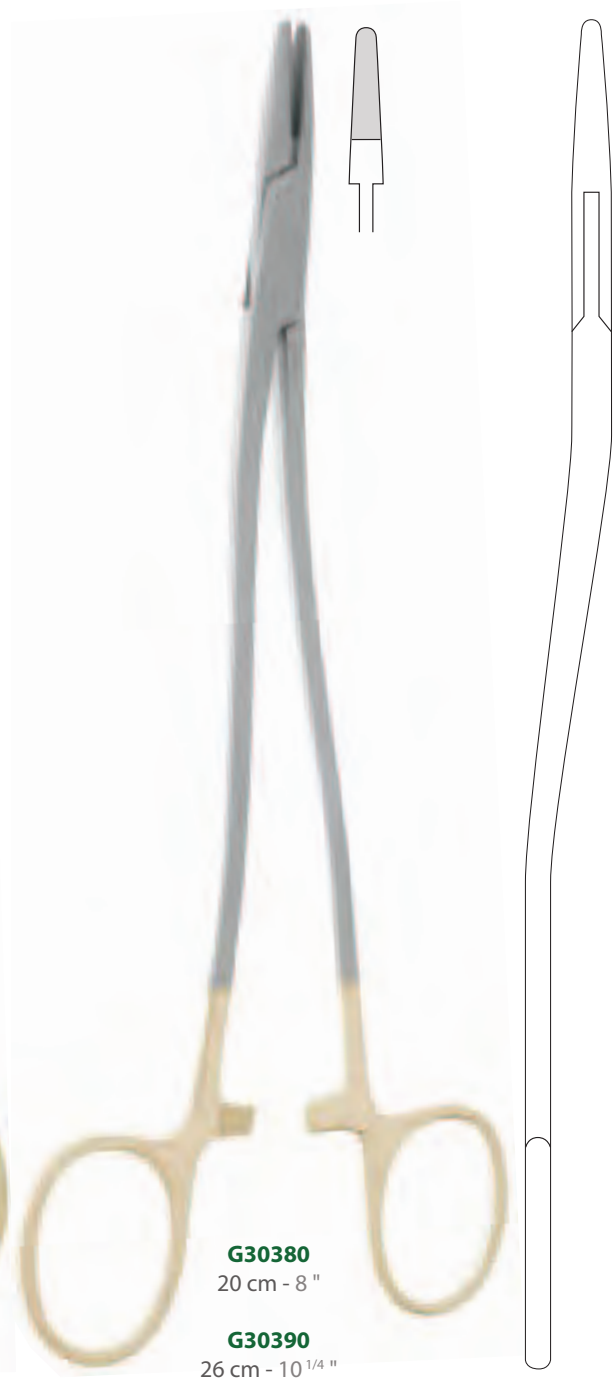

**G30380**  
20 cm - 8 "

**G30390**  
26 cm - 10 1/4 "

VI - Sutures  
VI - Sutures  
VI - Sutura

**VI - 12**

# LANDANGER

Porte-aiguilles - Needle holders - Porta agujas



## DEBAKEY

Standard	Fin
Standard	Fine
Standard	Fino

18 cm - 7 "	<b>G30152</b>	<b>G301521</b>
20 cm - 8 "	<b>G30153</b>	<b>G301531</b>
23 cm - 9 "	<b>G30154</b>	<b>G301541</b>
26 cm - 10 <sup>1</sup> / <sub>4</sub> "	<b>G30155</b>	<b>G301551</b>
30 cm - 11 <sup>3</sup> / <sub>4</sub> "	<b>G30156</b>	<b>G301561</b>



**G30152**  
18 cm - 7 "



**G30152**  
18 cm - 7 "



**G301521**  
18 cm - 7 "



**G30153**  
20 cm - 8 "



**G301531**  
20 cm - 8 "



**G30154**  
23 cm - 9 "



**G301541**  
23 cm - 9 "



**G30155**  
26 cm - 10 <sup>1</sup>/<sub>4</sub> "



**G301551**  
26 cm - 10 <sup>1</sup>/<sub>4</sub> "



**G30156**  
30 cm - 11 <sup>3</sup>/<sub>4</sub> "



**G301561**  
30 cm - 11 <sup>3</sup>/<sub>4</sub> "

VI - Sutures  
VI - Sutures  
VI - Sutura

# LANDANGER

## Porte-aiguilles - Needle holders - Porta agujas



### RYDER

### MICRO-RYDER

	Droit Straight Recta	Mors Jaws Bocas		Droit Straight Recta	Mors Jaws Bocas
13 cm - 5 "	<b>G30160</b>	1,2 mm		<b>G301601</b>	1,2 mm
15 cm - 6 "	<b>G30164</b>	1,5 mm		<b>G301641</b>	1,5 mm
18 cm - 7 "	<b>G30170</b>	1,7 mm		<b>G301701</b>	1,7 mm
20 cm - 8 "	<b>G30180</b>	2,0 mm		<b>G301801</b>	2,0 mm
23 cm - 9 "	<b>G30182</b>	2,2 mm		<b>G301821</b>	2,2 mm
26 cm - 10 <sup>1/4</sup> "	<b>G30190</b>	2,4 mm		<b>G301901</b>	2,4 mm

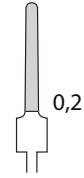
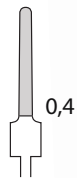

**G30170**  
18 cm - 7 "

# LANDANGER

Porte-aiguilles vasculaire - Needle holders vasculars - Porta agujas vascular



TC Inserts

## SAROT

- 18 cm - 7 " **G303210**
- 20 cm - 8 " **G303215**

## EUFRATE-PASQUE

- 14 cm - 5 1/2" **G303220**
- 16 cm - 6 1/4" **G303221**
- 18 cm - 7" **G303222**
- 20 cm - 8" **G303223**



VI - Sutures  
VI - Sutures  
VI - Sutura

# LANDANGER

Porte-aiguilles vasculaire - Needle holders vasculars - Porta agujas vascular

1/1



## EUFRATE

Modèle fin - Cardiovasculaire  
Fine model - Cardiovascular  
Modelo fino - Cardiovascular

Droite  
Straight  
Recta

13 cm - 5 "	<b>G30440</b>
15 cm - 6 "	<b>G30450</b>
20 cm - 8 "	<b>G30460</b>



VI - 16

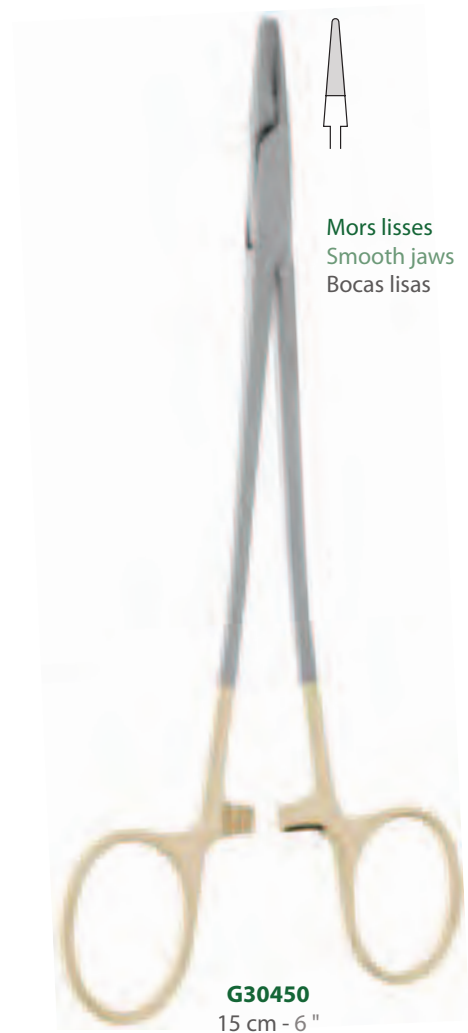



# LANDANGER

Porte-aiguilles coupe fil - Needle holders wire cutting - Porta agujas cortar ligaduras



## HEGAR-OLSEN-BABY

## HEGAR-OLSEN



VI - Sutures  
VI - Sutures  
VI - Sutura

# LANDANGER

Porte-aiguille coupe fil - Needle holders wire cutter - Porto agujas cortar ligaduras



## GILLIES-BABY

## GILLIES



**D01110**  
10,5 cm - 4 1/8 "



**B25800**  
16 cm - 6 1/4 "



**B25795**  
16 cm - 6 1/4 "  
Inox

VI - Sutures  
VI - Sutures  
VI - Sutura

**VI - 18**

# LANDANGER

Pinces à fils - Wire forceps - Pinza alambre



VI - Sutures  
VI - Sutures  
VI - Sutura

# LANDANGER

## Aiguilles à sutures - Suture Needles - Aguja de sutura



### REVERDIN

Inox  
Stainless steel  
Acero inoxidable



Droite Straight Recta	1/2 courbe Half curved Media curva	Courbe Curved Curva	Très courbe Very curved Muy curva
-----------------------------	--	---------------------------	---

19 cm - 7 1/2 "

**G35004**

**G35008**

**G35012**

**G35016**

21 cm - 8 1/4 "

**G35132**

**G35136**

**G35140**

**G35144**

(paroi)

VI - Sutures  
VI - Sutures  
VI - Sutura

**G35132**  
21 cm - 8 1/4 "

**VI - 20**

# LANDANGER

Aiguilles à ligature - Ligature needle - Aguja para ligaduras



## DOYEN

En hameçon  
Strongly curved  
Forma de anzuelo



**G40050**  
18 cm - 7"



**G40060**  
17 cm - 6<sup>3</sup>/<sub>4</sub>"



**G40070**  
18,5 cm - 7<sup>1</sup>/<sub>4</sub>"



**G40080**  
20 cm - 8"

VI - Sutures  
VI - Sutures  
VI - Sutura

# LANDANGER

Aiguilles à ligature - Ligature needles - Aguja para ligaduras

3/4

EMMET

PAUCHET  
(sabre)

NAKATA  
PAUCHET

STAMEY

1/1



**G40120**  
20 cm - 8"

**G40110**  
19 cm - 7 1/2"

**G40100**  
18 cm - 7"

**G40135**  
27 cm - 10 1/2"

**G401355**  
27 cm - 10 1/2"

**G401360**  
25 cm - 9 3/4"

VI - Sutures  
VI - Sutures  
VI - Sutura

**VI - 22**

# LANDANGER

Aiguilles à sutures - Suture needles - Agujas de sutura



## REDON

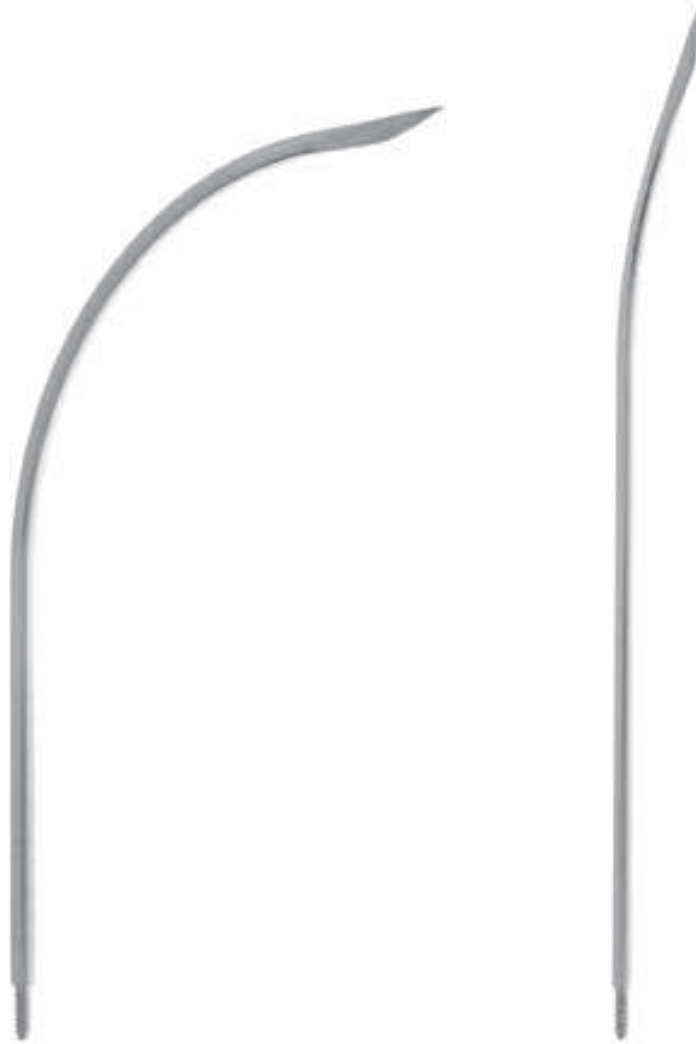

Courbe 20 cm  
Curved 8"  
Curva 20 cm



Droite 16 cm  
Straight 6 1/4"  
Recta 16 cm

<b>G40270</b>	2,3 mm / CH 07	<b>G40210</b>
<b>G402350</b>	2,5 mm / CH 08	<b>G401750</b>
<b>G40240</b>	3,0 mm / CH 09	<b>G40180</b>
<b>G40275</b>	3,3 mm / CH 10	<b>G40215</b>
<b>G40250</b>	4,0 mm / CH 12	<b>G40190</b>
<b>G402550</b>	4,6 mm / CH 14	<b>G401950</b>
<b>G40260</b>	5,0 mm / CH 15	<b>G40200</b>
<b>G402650</b>	5,3 mm / CH 16	<b>G402050</b>
<b>G402670</b>	6,0 mm / CH 18	<b>G402070</b>

VI - Sutures  
VI - Sutures  
VI - Sutura

# LANDANGER

## Aiguilles à ligature - Ligature needles - Aguja para ligaduras

1/1

### DESCHAMPS SCHAUTA

3/4



A droite  
To the right  
A la derecha

**G403510**  
28 cm - 11 "



A gauche  
To the left  
A la izquierda

**G403520**  
28 cm - 11 "

### DESCHAMPS



A droite  
To the right  
A la derecha

**G40340**  
20 cm - 8 "

**G403401**  
24 cm - 9 1/2 "



A gauche  
To the left  
A la izquierda

**G40350**  
20 cm - 8 "

**G403501**  
24 cm - 9 1/2 "

VI - Sutures  
VI - Sutures  
VI - Sutura

**VI - 24**



Écarteurs - Retractors - Separadores

FARABEU F FARABEU-CORTI CRILE LUER HARTMANN PARKER US ARMY ROUX HIBBS HEANEY RICHARDSON-EASTMAN MINI-LANGENBECK



P 1-2

CHIGOT FARABEU MEYERDING LOWE DESMARRS ABOULKER CUSHING SENN-MILLER RAGNEL KIENNY

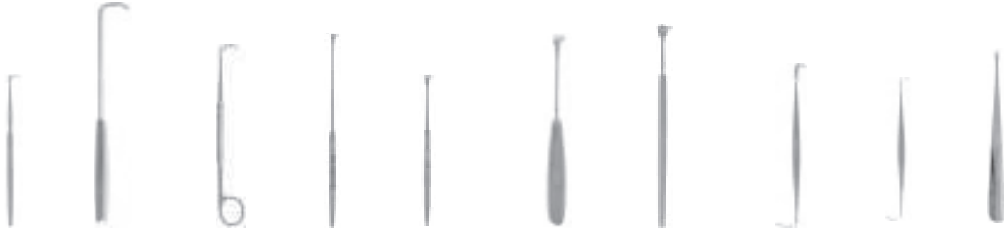

P 11

P 12

P 13

P 14

☒

BABY-SENN-MILLER CUSHING VOLKMANN KOCHER LAHEY ISRAEL OLLIER KOCHER KOCHER-LANGENBECK



P 20

P 20 ☒

KOCHER-WAGNER HÖSEL RICHARDSON KELLY BRUNNER LANGENBECK SIMON MARTIN MORRIS MIKULICZ



P 31

P 31

P 32

P 32

☒

KELLY POLOSSON HARRINGTON HARRINGTON PEMBERTON LERICHE DEAVER RÉTRACTEUR PROSTATIQUE FRITSCH MIDDELDORPF



P 37

P38 - P 39

P 40

P 40

☒

Écarteurs - Retractors - Separadores

RICARD RICARD-BEGOIN COTT PALMER OLIVIER KIRSCHNER DENIS-BROWN VERWYNL AUVERT

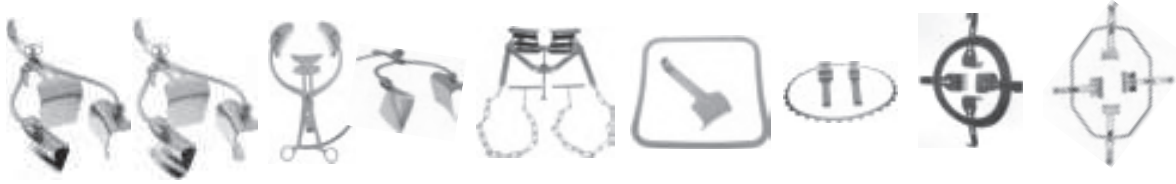

P 53 P 55 P 57 P 58 P 59 ☒

GOSSET MONTESTRUC BALFOUR HRYNTSCHAK ABADIE DARTIGUES FINOCHIETTO



P 65 - P 66 P 65 P 67 P 68 ☒

FINOCHIETTO ALU DUBOST BAILLEY TUFFIER ALM HEISS (HOLZEIMER) FINSEN JANSEN WEITLANER HENLEY



P 74 P 75 P 76 P 76 ☒

MAC KEE BECKMAN CONE BECKMAN BECKMAN DECOULX JOLL GELPI

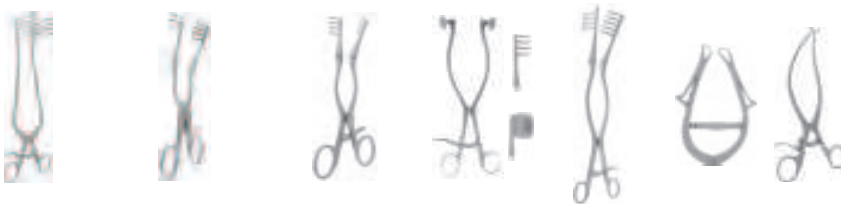

P 81 ☒

Valves malléables - Malleable blades - Valvulas maleables

LARDENOIS

Silicone surmoulée  
Silicon coated  
Silicone moldeadas



P 7 P 8 P 9 P 10

Crochets - Hooks - Ganchos

DESMARRES BERGMANN LERICHE JOSEPH GILLIES



P 17 P 17 P 17 P 18 P 18

Écarteurs valves - Retractors blades - Separadores valvulas

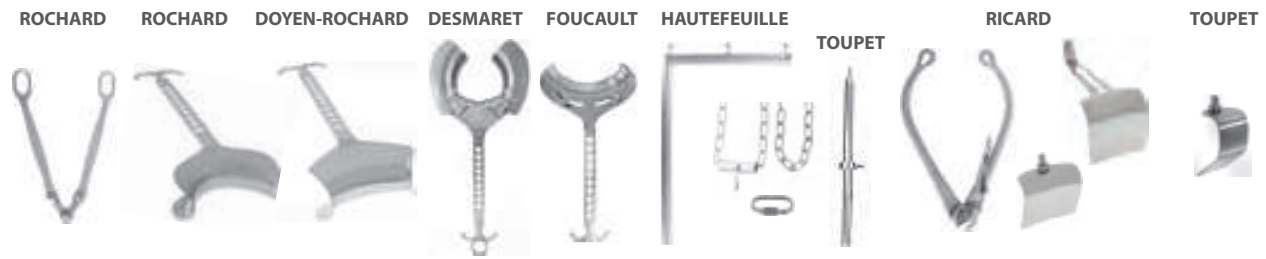

P 47

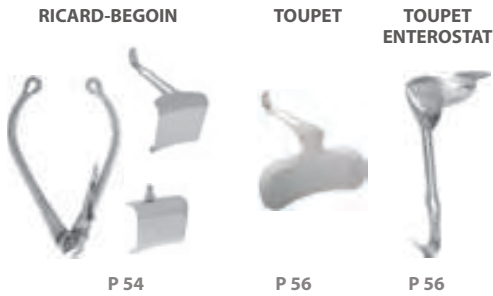

Écarteurs neuro - Neuro retractors - Separadores neuro

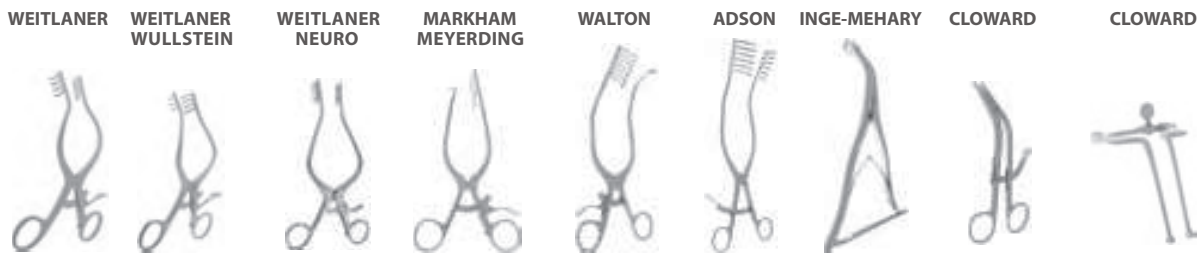

P 98

Écarteurs osseux - Osseous Retractors - Separadores oseos



VIII - Voies basses  
 VIII - Gyne/Uro/Procto  
 VIII - Gyne/Uro/Procto

Valves vaginales - Vaginal blades - Valvulas vaginales

JAYLE DOYEN MANGIAGALLI DOUGLAS KRISTELLER BRIESKY DARGENT



P 41

P 42

XI - Neurochirurgie  
 XI - Neurosurgery  
 XI - Neurocirugía

Spatule - Spatula - Espátula

CLOVIS-VINCENT CUSHING OLIVECRONA HEIFETZ



P 3

P 4

P 4

P 4

P 4

P 5

Écarteur - Retractor - Separador

HOLSHER TAYLOR



P 6

P 6

XII - O.R.L.  
 XII - E.N.T.  
 XII - O.R.L.

Divers - Miscellaneous - Diversas

CLAOUE AUBRY DAUTREY



P 36

P 36

P 36

XIII - Osseux  
 XIII - Bone surgery  
 XIII - Cirugía osea

Bankart - Bankart - Bankart

Danis - Danis - Danis

CHARNLEY MERLE D'AUBIGNE



☒

SMILLIE-TRILLAT TRILLAT



P 106

P 107

P 111

### FARABEUF

Jeu de 2 - Set of 2 - Juego de 2

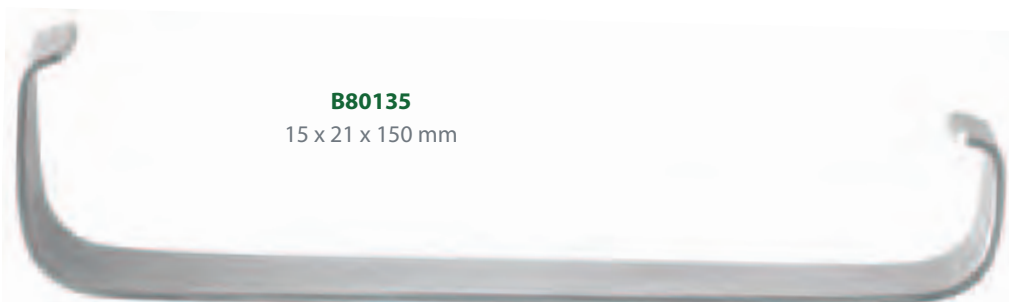
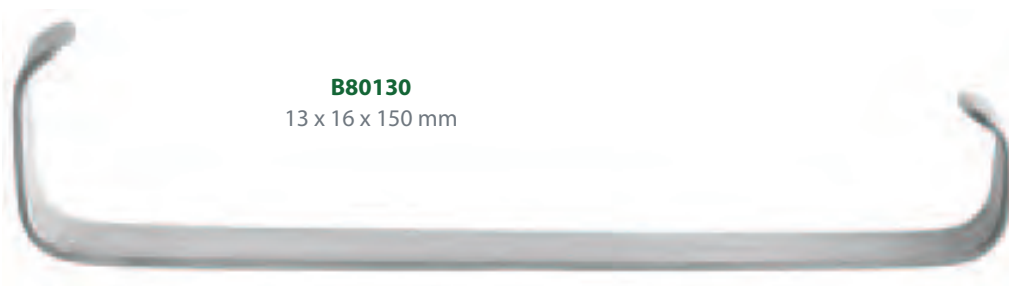
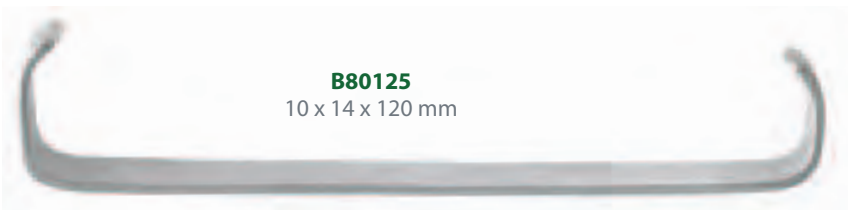
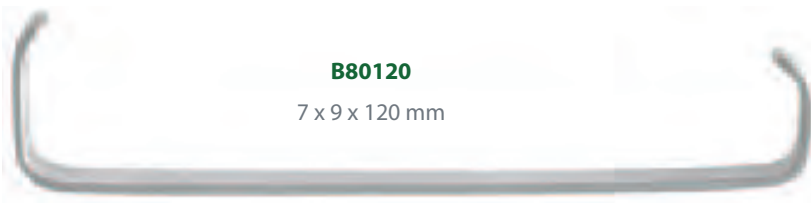

# LANDANGER

Écarteurs - Retractors - Separadores

## FARABEUF

Fabrication spéciale - Écarteur de FARABEUF (paire)  
Special manufacture - FARABEUF retractor (pair)  
Fabricación especial - Separador de FARABEUF (par)

<b>Établissement :</b> Establishment Establecimiento		
<b>Rédigé par :</b> Written by Escrito por	<b>Date :</b> Date Fecha	<b>Visa :</b> Visa Visa

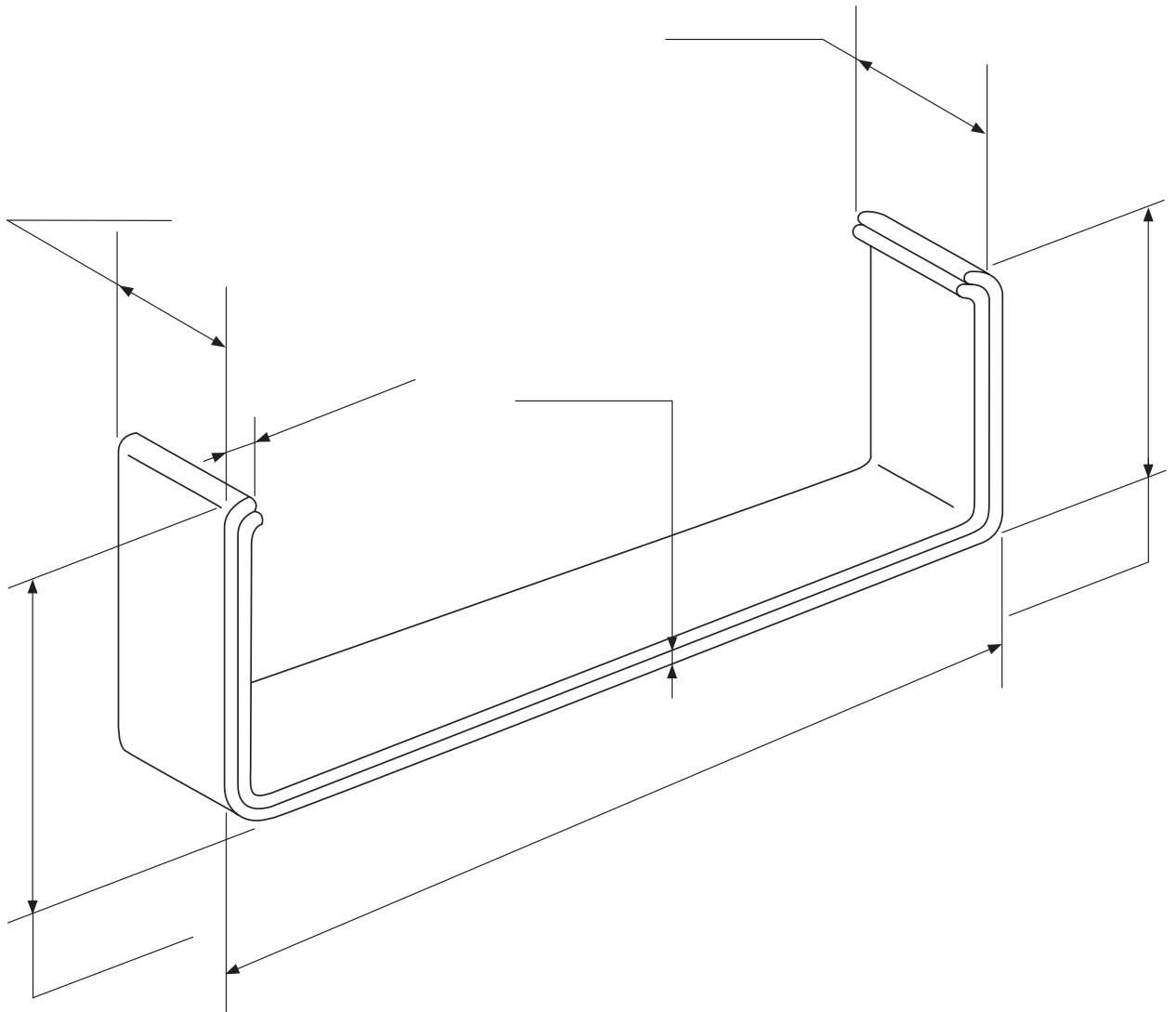

VII - Écarteurs  
VII - Retractors  
VII - Separadores

VII - 2

Retournez-nous ce document par télécopie (+33 3 25 02 10 20) ou par mail (clientele@landanger.com) avec vos coordonnées complètes.  
Send us back this document by fax (+33 3 25 02 10 20) or by mail (clientele@landanger.com) with your full contact details.  
Envíanos este documento por fax (+33 3 25 02 10 20) o por correo (clientele@landanger.com) con su dirección completa.

# LANDANGER

Écarteurs - Retractors - Separadores



## FARABEU-FORTI

35 x 45 mm



Jeu de 2  
Set of 2  
Juego de 2

40 x 65 mm

**B80136**  
20 cm - 8 "

## CRILE

6 x 20 mm



4 x 12 mm

**B801363**  
11 cm - 4 1/4 "

## LUER

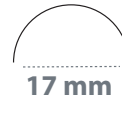

17 mm



14 mm



**B80137**  
11 cm - 4 1/4 "

# LANDANGER

Écarteurs - Retractors - Separadores



## HARTMANN

Jeu de 2  
Set of 2  
Juego de 2



**B80140**  
16 cm - 6 1/4 "

## PARKER LANGENBECK (US ARMY)

Jeu de 2  
Set of 2  
Juego de 2



**B801480**  
21 cm - 8 1/4 "

## ROUX

Jeu de 3  
Set of 3  
Juego de 3



**B80145**  
170 mm - 6 3/4 "

À l'unité  
Per unit  
La unidad

**B801451 n° 1**  
14 cm - 5 1/2 "  
**B801452 n° 2**  
15 cm - 6 "  
**B801453 n° 3**  
17 cm - 6 3/4 "



# LANDANGER

Écarteurs - Retractors - Separadores

 3/4

## HIBBS

## HEANEY



**B801364**  
25 x 75 mm  
24 cm - 9 1/2"

**B801365**  
25 x 80 mm  
24 cm - 9 1/2"



**B801366**  
45 x 25 mm  
27 cm - 10 1/2"

**B801367**  
73 x 28 mm  
27 cm - 10 1/2"

**B801368**  
82 x 28 mm  
27 cm - 10 1/2"

**B801364**  
24 cm - 9 1/2"

**B801367**  
27 cm - 10 3/4"

VII - Écarteurs  
VII - Retractors  
VII - Separadores

# LANDANGER

Écarteurs - Retractors - Separadores

3/4

## RICHARDSON-EASTMAN



36 x 28 mm

28 x 20 mm

**B801474**

26 cm - 10 <sup>1</sup>/<sub>4</sub> "



71 x 43 mm

49 x 38 mm

**B801476**

28 cm - 11 "

Jeu de 2  
Set of 2  
Juego de 2

**B801478**

26 et 28 cm - 10 <sup>1</sup>/<sub>4</sub> " and 11 "

VII - Écarteurs  
VII - Retractors  
VII - Separadores

**VII - 6**

# LANDANGER

Écarteurs valves malléables - Retractors malleable blades - Separadores valvulas maleables

## LARDENOIS

25 mm



25 mm



40 mm  
**B80380**  
27 cm - 10 1/2 "

25 mm



65 mm  
**B80382**  
27 cm - 10 1/2 "



45 mm  
**B80385**  
36 cm - 14 1/4 "

VII - Écarteurs  
VII - Retractors  
VII - Separadores

# LANDANGER

Écarteurs valves malléables - Retractors malleable blades - Separadores valvulas maleables

3/4

## LARDENOIS

Largeur  
Width  
Anchura

6 mm	<b>B803910</b>
8 mm	<b>B803911</b>
10 mm	<b>B803912</b>
12 mm	<b>B803913</b>
17 mm	<b>B803914</b>
20 mm	<b>B80386</b>
25 mm	<b>B803915</b>

Largeur  
Width  
Anchura

25 mm	<b>B803920</b>
30 mm	<b>B80388</b>

Largeur  
Width  
Anchura

20 mm	<b>B803930</b>
25 mm	<b>B803931</b>
30 mm	<b>B803932</b>
35 mm	<b>B803933</b>
40 mm	<b>B803934</b>
45 mm	<b>B803935</b>
50 mm	<b>B803936</b>
64 mm	<b>B803937</b>
76 mm	<b>B803938</b>
102 mm	<b>B803939</b>



**B80386**  
20 cm - 8 "



**B80388**  
25 cm - 10 "



**B803930**  
33 cm - 13 "

# LANDANGER

Écarteurs valves malléables - Retractors malleable blades - Separadores valvulas maleables



30 mm



**B80390**  
36 cm - 14 1/4"

VALVE À POU MON  
BLADE FOR LUNG  
VALVULA PARA PULMÓN

50 mm



**B80400**  
30 cm - 11 3/4"

80 mm



**B80405**  
30 cm - 11 3/4"

100 mm



**B80410**  
30 cm - 11 3/4"

VII - Écarteurs  
VII - Retractors  
VII - Separadores

# LANDANGER

Écarteurs valves malléables - Retractors malleable blades - Separadores valvulas maleables

SILICONE SURMOULÉE  
SILICON COATED  
SILICONE MOLDEADAS

Valves souples  
Flexible blades  
Válvulas ligeras

Avec 2 points d'accrochage - With 2 anchors - Con 2 puntos de enganche



**B803940**  
50 mm  
30 cm - 11 <sup>3/4</sup> "

Avec 4 points d'accrochage - With 4 anchors - Con 4 puntos de enganche



**B803941**  
50 mm  
30 cm - 11 <sup>3/4</sup> "

Valve ferme  
Firm blade  
Válvula rigida

Sans point d'accrochage - Without any anchor - Sin puntos de enganche



**B803942**  
50 mm  
30 cm - 11 <sup>3/4</sup> "

VII - Écarteurs  
VII - Retractors  
VII - Separadores

# LANDANGER

Écarteurs - Retractors - Separadores



## MINI-LANGENBECK

## CHIGOT

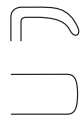

**B802862**  
10 x 6 mm

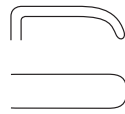

**B802863**  
17 x 5 mm

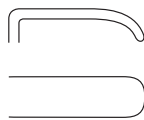

**B802864**  
20 x 6 mm

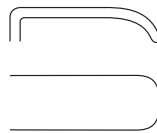

**B802865**  
22 x 8 mm

**B802863**  
16 cm - 6 1/4"



**B80081**  
6 mm x 10 mm



**B80083**  
6 mm x 20 mm

**B80081**  
15 cm - 6"

VII - Écarteurs  
VII - Retractors  
VII - Separadores

# LANDANGER

Écarteurs - Retractors - Separadores



## FARABEUF



Largeur  
Width  
Anchura

8 mm **B80085**

10 mm **B80090**

12 mm **B80095**

14 mm **B80100**

16 mm **B80105**

18 mm **B80110**

20 mm **B80115**

**B80085**

22 cm - 8 <sup>3</sup>/<sub>4</sub> "

VII - Écarteurs  
VII - Retractors  
VII - Separadores

**VII - 12**



### MEYERDING



Sans griffes  
Without teeth  
Sin dientes

Sans griffes  
Without teeth  
Sin dientes

Sans griffes  
Without teeth  
Sin dientes

3 griffes  
3 teeth  
3 dientes

3 griffes pointues  
3 sharp teeth  
3 dientes agudas



**B803101**  
18 cm - 7 "  
18 x 7 mm



**B803104**  
18 cm - 7 "  
10 x 3 mm



**B803105**  
18 cm - 7 "  
7 x 4 mm



**B803102**  
18 cm - 7 "  
16 x 5 mm



**B803106**  
18 cm - 7 "

**B803103**  
18 cm - 7 "  
7 x 4 mm

# LANDANGER

Écarteurs - Retractors - Separadores



LOWE



VII - Écarteurs  
VII - Retractors  
VII - Separadores

# LANDANGER

Écarteurs - Retractors - Separadores



## DESMARRES

## ABOULKER

Malléable  
Malleable  
Maleable

10 mm	14 mm
<b>B80312</b>	<b>B80314</b>
<b>B80316</b>	<b>B80318</b>

19 cm - 7 1/2 "  
25 cm - 10 "

**B80301**  
6 mm

**B80302**  
8 mm

**B80303**  
10 mm

**B80304**  
12 mm

**B80306**  
15 mm

**B80312**  
19 cm - 7 1/2 "

**B80301**  
15 cm - 6 "

VII - Écarteurs  
VII - Retractors  
VII - Separadores

# LANDANGER

Écarteurs - Retractors - Separadores



## CUSHING



Largeur  
Width  
Anchura

8 mm	<b>B803080</b>
10 mm	<b>B803081</b>
12 mm	<b>B803082</b>
14 mm	<b>B803083</b>
16 mm	<b>B803084</b>
18 mm	<b>B803085</b>



**B803080**



**B803083**



**B803084**



**B803085**



Largeur  
Width  
Anchura

8 mm	<b>B803090</b>
10 mm	<b>B803091</b>
12 mm	<b>B803092</b>
14 mm	<b>B803093</b>
16 mm	<b>B803094</b>
18 mm	<b>B803095</b>



**B803091**



**B803092**



**B803094**

VII - Écarteurs  
VII - Retractors  
VII - Separadores

**VII - 16**

20 cm - 8 "

24 cm - 9 <sup>1</sup>/<sub>2</sub>"

# LANDANGER

Écarteurs, crochets - Retractors, hooks - Separadores, ganchos



## DESMARRES AJOURE

## BERGMANN

## LERICHE

Largeur  
Width  
Anchura

12 mm	<b>B803070</b>
14 mm	<b>B803071</b>
16 mm	<b>B803072</b>
18 mm	<b>B803073</b>



Ajouré  
Open work  
Con ventana

**B803070**  
14 cm - 5 1/2"



**B803320**  
14 cm - 5 1/2"



**B80336**  
20 cm - 8"

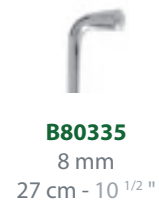
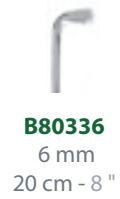
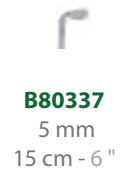

# LANDANGER

Écarteurs, crochets - Retractors, hooks - Separadores, ganchos



## JOSEPH

1 griffe  
1 tooth  
1 diente

**I171290**

Largeur 2 griffes  
Width 2 teeth  
Anchura 2 dientes

3 mm **I171292**

5 mm **I171295**

7 mm **I171297**

10 mm **I171300**

4 mm



**I171290**  
15 cm - 6 "



**I171292**  
16 cm - 6 1/4 "



3 mm



5 mm



7 mm



10 mm

## GILLIES



**B80348**  
18 cm - 7 "



**B80348**  
n° 1 - 2,5 mm



**B80349**  
n°2 - 3 mm



**B80350**  
n°3 - 3,5 mm



**B80351**  
n° 4 - 4 mm



**B80353**  
double - 6 mm

VII - Écarteurs  
VII - Retractors  
VII - Separadores

# LANDANGER

## Écarteurs - Retractors - Separadores



### SENN-MILLER

Mousse      Pointu  
Blunt        Sharp  
Romo        Agudo

16 cm - 6 1/4 "

**B80327**

**B80325**



9 x 7 mm



7 x 20 mm



**B80325**

16 cm - 6 1/4 "

### RAGNEL



4 x 8 mm



6 x 15 mm



**B80328**

14 cm - 5 1/2 "

### KIENNY

Chausse veine  
Vein holder  
Porta veina



4 mm



**B80330**

17 cm - 6 3/4 "

# LANDANGER

Écarteurs - Retractors - Separadores



## BABY-SENN-MILLER

Mousse      Pointu  
Blunt        Sharp  
Romo        Agudo

15 cm - 6"

**B803275**

**B803255**



**B803275**  
15 cm - 6"

## CUSHING

11 x 30 mm



**B803290**  
20 cm - 8"



VOLKMANN

Pointu  
Sharp  
Agudo



**B801490**

Mousse  
Blunt  
Romo



**B801491**



**B801490**  
22 cm - 8 3/4''

1 griffe  
1 tooth  
1 diente

Pointu  
Sharp  
Agudo



**B801492**

Mousse  
Blunt  
Romo



**B801493**



**B801492**  
22 cm - 8 3/4''

# LANDANGER

## Écarteurs - Retractors - Separadores



Pointu  
Sharp  
Agudo

**VOLKMANN**

Mousse  
Blunt  
Romo



**B80150**

2 griffes  
2 teeth  
2 dientes

8 mm



**B80155**



**B80160**

3 griffes  
3 teeth  
3 dientes

13 mm



**B80165**



**B80170**

4 griffes  
4 teeth  
4 dientes

19 mm



**B80175**



**B80190**

6 griffes  
6 teeth  
6 dientes

28 mm



**B80195**



**B80210**

8 griffes  
8 teeth  
8 dientes

36 mm



**B80215**



22 cm - 8<sup>5/8"</sup>

# LANDANGER

## Écarteurs - Retractors - Separadores



Pointu  
Sharp  
Agudo

**VOLKMANN**

Mousse  
Blunt  
Romo

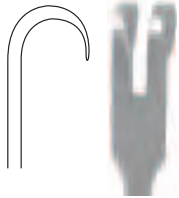

**B80151**

2 griffes  
2 teeth  
2 dientes

8 mm

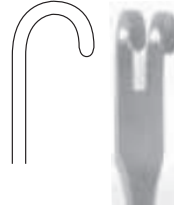

**B80156**



**B80161**

3 griffes  
3 teeth  
3 dientes

13 mm



**B80166**



**B80171**

4 griffes  
4 teeth  
4 dientes

19 mm



**B80176**



**B80191**

6 griffes  
6 teeth  
6 dientes

28 mm



**B80196**



**B80211**

8 griffes  
8 teeth  
8 dientes

36 mm



**B80216**



21 cm - 8 1/4"

**VII - 23**

VII - Écarteurs  
VII - Retractors  
VII - Separadores



### VOLKMANN

Pointu  
Sharp  
Agudo

Mousse  
Blunt  
Romo

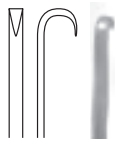

1 griffe  
1 tooth  
1 diente

**B80218**

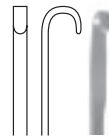

**B80219**



2 griffes  
2 teeth  
2 dientes  
6 mm

**B80220**



**B80225**



3 griffes  
3 teeth  
3 dientes  
9 mm

**B80240**



**B80245**



4 griffes  
4 teeth  
4 dientes  
12 mm

**B80266**



**B80267**



**B80225**  
15 cm - 6 "

# LANDANGER

## Écarteurs - Retractors - Separadores



Mousse  
Blunt  
Romo

**KOCHER**

Pointu  
Sharp  
Agudo

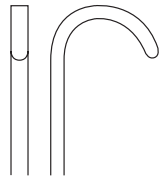

**B802872**

1 griffe  
1 tooth  
1 diente

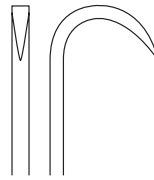

**B802866**

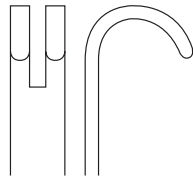

**B802873**

2 griffes  
2 teeth  
2 dientes

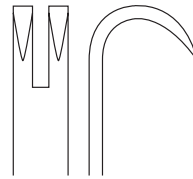

**B802867**

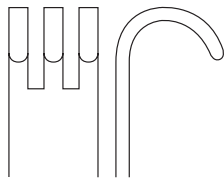

**B802874**

3 griffes  
3 teeth  
3 dientes

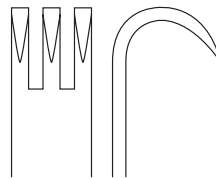

**B802868**

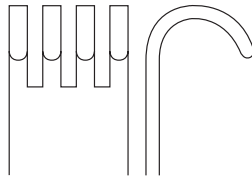

**B802875**

4 griffes  
4 teeth  
4 dientes

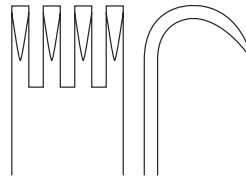

**B802869**

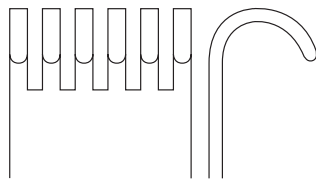

**B802876**

6 griffes  
6 teeth  
6 dientes

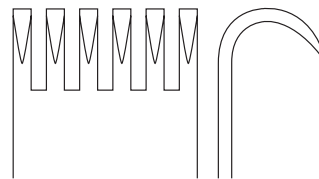

**B802870**

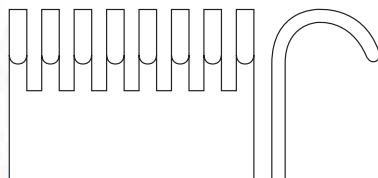

**B802877**

8 griffes  
8 teeth  
8 dientes

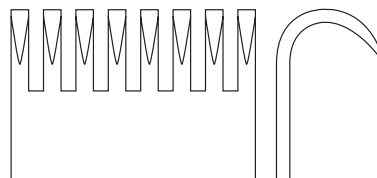

**B802871**

36 mm



**B802875**

22 cm - 8 3/4 "

**B802869**

22 cm - 8 3/4 "

**VII - 25**

VII - Écarteurs  
VII - Retractors  
VII - Separadores

# LANDANGER

## Écarteurs - Retractors - Separadores



### KOCHER

Modèle fort - 1 griffe  
Strong model - 1 tooth  
Modelo fuerte - 1 diente

Pointu  
Sharp  
Agudo



**B802880**  
20 cm - 8"

Mousse  
Blunt  
Romo



**B802881**  
20 cm - 8"

### LAHEY



**B802883**  
19 cm - 7 1/2"

# LANDANGER

Écarteurs - Retractors - Separadores

ISRAEL

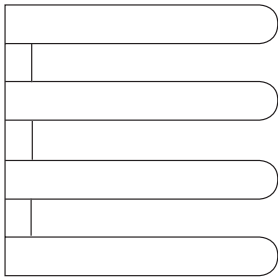

**B80268**  
40 mm x 40 mm

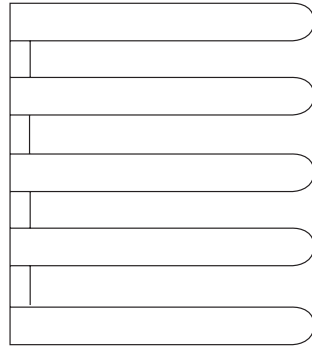

**B80269**  
45 mm x 50 mm

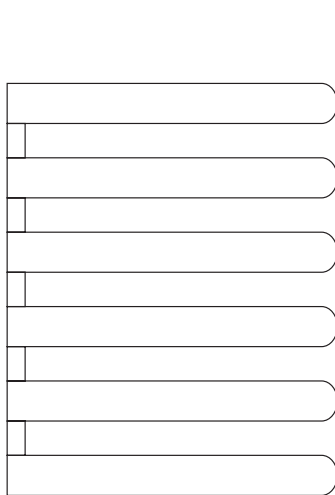

**B80270**  
50 mm x 60 mm

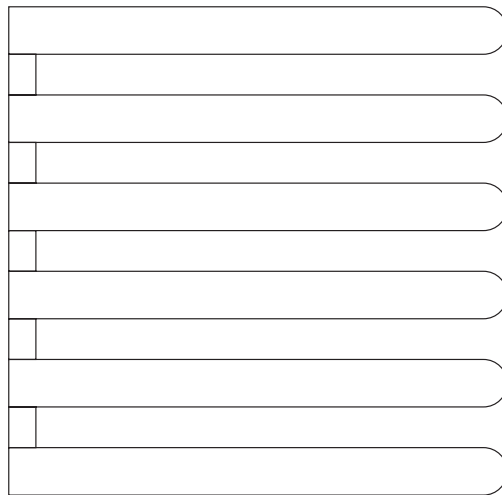

**B80271**  
70 mm x 70 mm



**B80268**  
23 cm - 9 "

VII - Écarteurs  
VII - Retractors  
VII - Separadores

# LANDANGER

Écarteurs - Retractors - Separadores

1/1

## OLLIER

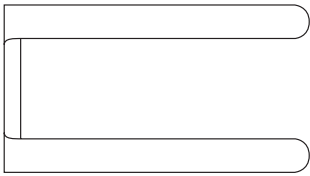

**B80360**  
25 x 45 mm

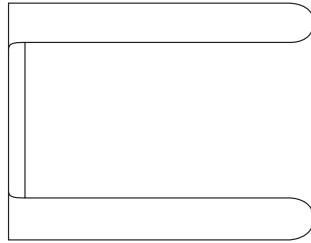

**B80365**  
35 x 45 mm

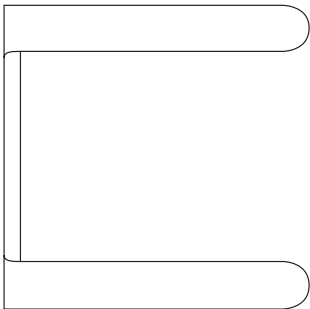

**B80370**  
45 x 45 mm

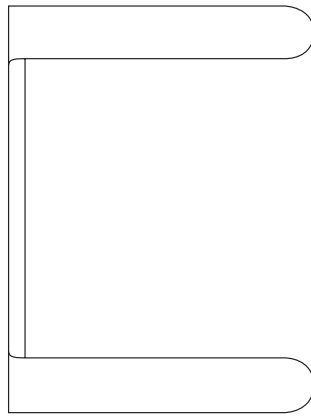

**B80375**  
60 x 45 mm



**B80360**  
22 cm - 8 3/4 "



# LANDANGER

Écarteurs - Retractors - Separadores



## KOCHER



**B80275**  
40 x 18 mm

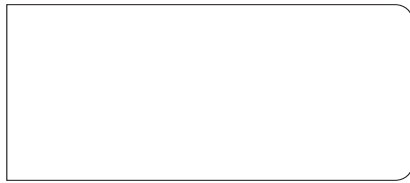

**B80276**  
60 x 25 mm

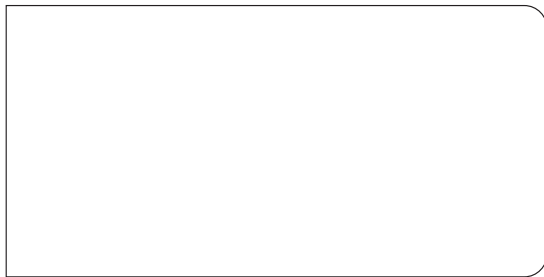

**B80277**  
80 x 40 mm

**B80275**  
22 cm - 8 <sup>3</sup>/<sub>4</sub> "



70 x 25 mm

**B80270**  
22,5 cm - 8 <sup>4</sup>/<sub>5</sub> "

VII - Écarteurs  
VII - Retractors  
VII - Separadores

# LANDANGER

Écarteurs - Retractors - Separadores



## KOCHER-LANGENBECK



**B802885**  
25 x 6 mm

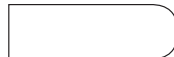

**B802886**  
25 x 8 mm



**B802892**  
70 x 14 mm



**B802887**  
35 x 8 mm

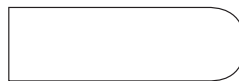

**B802888**  
35 x 11 mm



**B802893**  
80 x 12 mm



**B802889**  
35 x 15 mm



**B802890**  
42 x 11 mm



**B802894**  
80 x 16 mm



**B802891**  
55 x 11 mm

**B802885**  
21,5 cm - 8 1/2 ''

VII - Écarteurs  
VII - Retractors  
VII - Separadores

**VII - 30**

# LANDANGER

Écarteurs - Retractors - Separadores

KOCHER - WAGNER

HÖSEL



**B802743**  
67 x 25 mm

**B802741**  
22 x 15 mm

**B802744**  
100 x 35 mm

**B802740**  
38 x 20 mm



**B802749**  
100 x 30 mm

**B802745**  
120 x 30 mm

**B802746**  
140 x 30 mm

**B802748**  
140 x 40 mm

**B802743**  
28 cm - 11 "

**B802740**  
28 cm - 11 "

**B802746**  
25 cm - 10 "

VII - Écarteurs  
VII - Retractors  
VII - Separadores

# LANDANGER

Écarteurs - Retractors - Separadores

4/5

## RICHARDSON



**B801462**  
28 x 20 mm

**B801464**  
30 x 28 mm

**B801466**  
38 x 37 mm

**B801468**  
52 x 22 mm

## KELLY



**B801470**  
40 x 50 mm

**B801471**  
50 x 65 mm

**B801472**  
65 x 75 mm

**B801473**  
75 x 90 mm

**B801464**  
24 cm - 9 1/2 "

**B801470**  
26 cm - 10 1/4 "

# LANDANGER

Écarteurs - Retractors - Separadores



## BRUNNER



**B802771**  
100 x 25 mm

**B802772**  
140 x 30 mm

**B802774**  
160 x 30 mm

**B802776**  
180 x 30 mm

**B802774**  
25 cm - 10"

**B80285**  
21 cm - 8 1/4"

## LANGENBECK



**B80278**  
30 x 10 mm



**B80279**  
30 x 14 mm

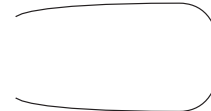

**B80280**  
30 x 16 mm



**B80281**  
40 x 10 mm



**B80282**  
43 x 13 mm

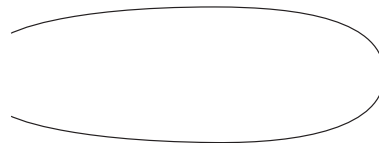

**B80283**  
55 x 20 mm

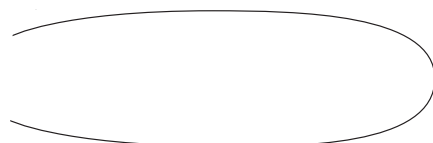

**B80285**  
63 x 20 mm

VII - Écarteurs  
VII - Retractors  
VII - Separadores

# LANDANGER

Écarteurs - Retractors - Separadores

3/4

SIMON

MARTIN



**B802715**  
115 x 22 mm

**B802716**  
115 x 27 mm

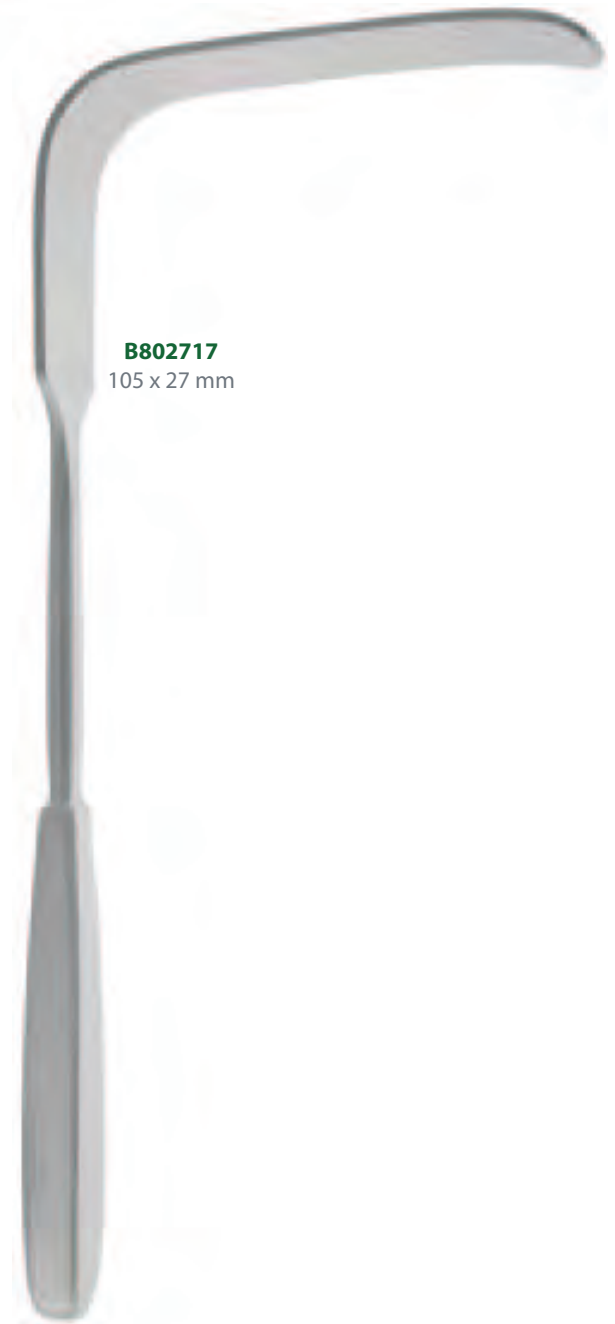

**B802717**  
105 x 27 mm

VII - Écarteurs  
VII - Retractors  
VII - Separadores

**VII - 34**

**B802715**  
28 cm - 11 "

**B802717**  
26 cm - 10 <sup>1</sup>/<sub>4</sub> "

### MORRIS



**B802920**  
70 x 50 mm

**B802921**  
70 x 65 mm

**B802920**  
21 cm - 8 1/4"

# LANDANGER

Écarteurs - Retractors - Separadores

3/4

MIKULICZ



**B80273**  
26 cm - 10 1/4 "

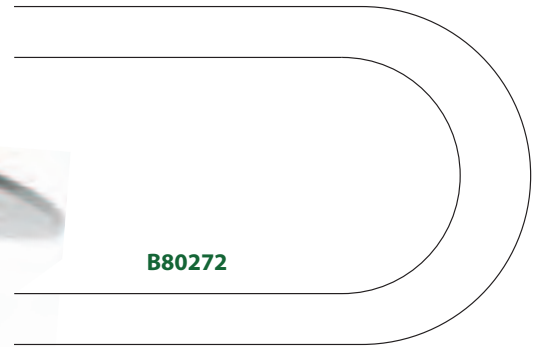

**B80272**

**B80273 et B80274**

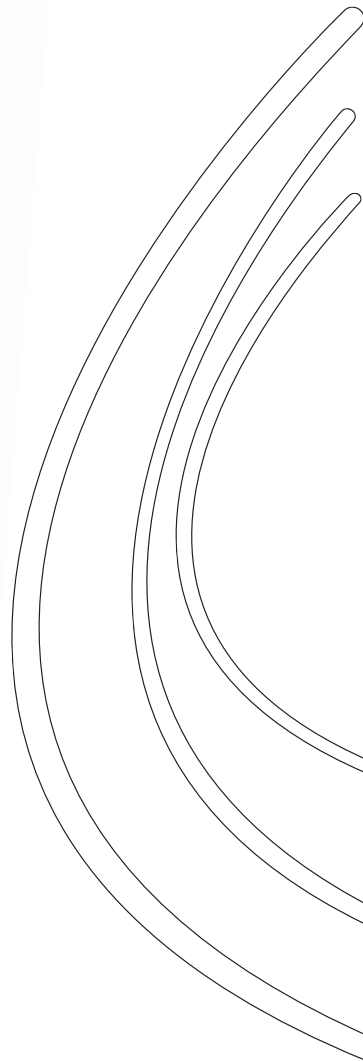

**B80272**  
85 x 35 mm

**B80273**  
120 x 50 mm

**B80274**  
155 x 50 mm

VII - Écarteurs  
VII - Retractors  
VII - Separadores

**VII - 36**



KELLY



**B802719**  
190 x 38 mm

**B802742**  
190 x 57 mm

**B802742**  
27 cm - 10 1/2 "

# LANDANGER

Écarteurs - Retractors - Separadores

3/4

## POLOSSON



**B80420**  
45 mm

**B80425**  
60 mm

**B80425**  
29 cm - 11 1/2"

VII - Écarteurs  
VII - Retractors  
VII - Separadores

**VII - 38**

### POLOSSON

Ajouré  
Open work  
Con ventana



**B804150**  
25 mm

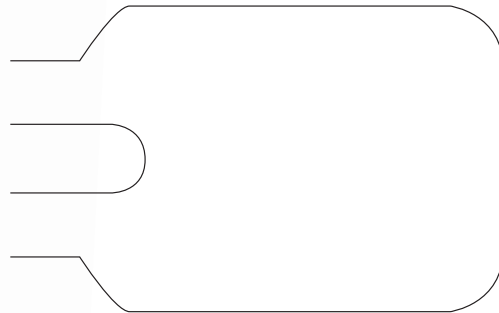

**B80422**  
45 mm

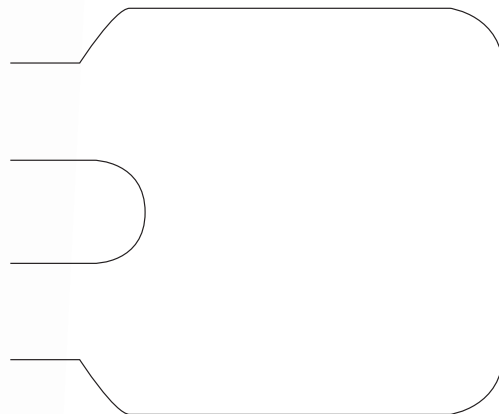

**B80427**  
60 mm

**B80422**  
26,5 cm - 10 1/2"

# LANDANGER

Écarteurs - Retractors - Separadores



HARRINGTON

HARRINGTON-PEMBERTON



**B804310**  
40 x 127 mm

**B804310**  
32 cm - 12 1/2"



**B804320**  
64 x 175 mm

**B804320**  
32 cm - 12 1/2"

VII - Écarteurs  
VII - Retractors  
VII - Separadores

**VII - 40**

# LANDANGER

## Valves - Blades - Valvulas



### LERICHE

Largeur  
Width  
Anchura

Petite courbure  
Short curvature  
Curva pequeña

Moyenne  
Medium  
Medio

Grande courbure  
Long curvature  
Curva grande

21 cm - 8 1/4 "	26 cm - 10 1/4 "	30 cm - 12 "
<b>B80435</b>	<b>B804422</b>	<b>B80443</b>
<b>B80440</b>	<b>B804424</b>	<b>B80444</b>
<b>B80442</b>	<b>B804426</b>	<b>B80445</b>

35 mm  
45 mm  
60 mm

### OBESE

21 cm - 8 1/4 "

90 mm

**B804280**

### LERICHE - BUGATTI

Largeur  
Width  
Anchura

Très grande courbure  
Very long curvature  
Curva muy grande

39 cm - 15 1/3 "

48 mm

**B804285**

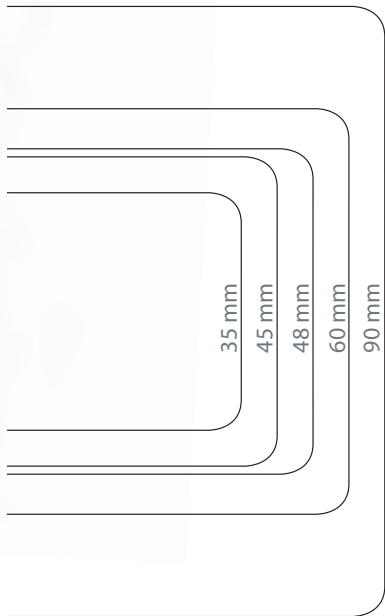

**B80435**

21 cm - 8 1/4 "

VII - Écarteurs  
VII - Retractors  
VII - Separadores

# LANDANGER

Écarteurs - Retractors - Separadores



## DEAVER



Largeur  
Width  
Anchura

18 cm - 7 "	19 mm	<b>B804460</b>
22 cm - 8 <sup>3</sup> / <sub>4</sub> "	22 mm	<b>B804461</b>
23 cm - 9 "	25 mm	<b>B804462</b>
30 cm - 11 <sup>3</sup> / <sub>4</sub> "	25 mm	<b>B804463</b>
33 cm - 13 "	25 mm	<b>B804464</b>
36 cm - 14 <sup>1</sup> / <sub>4</sub> "	25 mm	<b>B804465</b>
30 cm - 11 <sup>3</sup> / <sub>4</sub> "	38 mm	<b>B804466</b>
30 cm - 11 <sup>3</sup> / <sub>4</sub> "	50 mm	<b>B804467</b>
30 cm - 11 <sup>3</sup> / <sub>4</sub> "	75 mm	<b>B804468</b>



**B804460**  
18 cm - 7 "

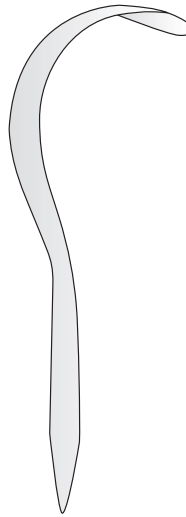

**B804461**  
22 cm - 8 <sup>3</sup>/<sub>4</sub> "

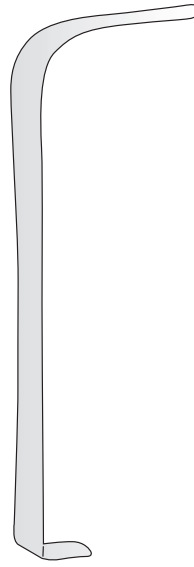

**B804462**  
23 cm - 9 "

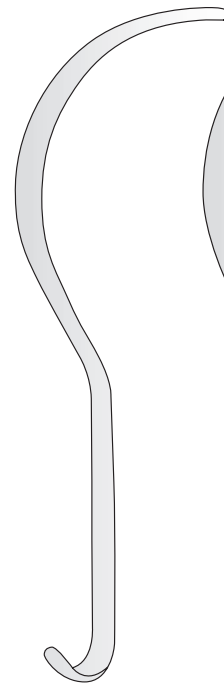

**B804463**  
30 cm - 11 <sup>3</sup>/<sub>4</sub> "



**B804466**  
30 cm - 11 <sup>3</sup>/<sub>4</sub> "

**B804460**  
18 cm - 7 "

VII - Écarteurs  
VII - Retractors  
VII - Separadores

# LANDANGER

Écarteurs - Retractors - Separadores

## DEAVER

## RETRACTEUR PROSTATIQUE



**B804470**  
25 mm

**B804471**  
38 mm

Manche grip  
Grip handle  
Mango grip

**B804471**  
30 cm - 11 <sup>3</sup>/<sub>4</sub> "



28 mm

**B804600**  
36 cm - 14 <sup>1</sup>/<sub>4</sub> "

VII - Écarteurs  
VII - Retractors  
VII - Separadores

# LANDANGER

Écarteurs - Retractors - Separadores



FRITSCH



40 x 40 mm

**B802929**  
24 cm - 9 1/2"



**B802930**  
45 x 60 mm  
24 cm - 9 1/2"



**B802931**  
45 x 75 mm  
24 cm - 9 1/2"

VII - Écarteurs  
VII - Retractors  
VII - Separadores

**VII - 44**



# LANDANGER

Écarteurs - Retractors - Separadores

## MIDDELDORPF



**B802922**  
22 cm - 8 <sup>3</sup>/<sub>4</sub> "



21 x 22 mm

**B802923**  
26 x 30 mm  
23,5 cm - 9 <sup>1</sup>/<sub>4</sub> "



**B802924**  
22 cm - 8 <sup>3</sup>/<sub>4</sub> "



21 x 22 mm

**B802925**  
26 x 30 mm  
23,5 cm - 9 <sup>1</sup>/<sub>4</sub> "

# LANDANGER

Écarteurs - Retractors - Separadores



## MIDDELDORPF



45 x 45 mm

**B802926**  
25,5 cm - 10 "



**B802927**  
45 x 50 mm  
25,5 cm - 10 "



**B802928**  
55 x 70 mm  
25,5 cm - 10 "

VII - Écarteurs  
VII - Retractors  
VII - Separadores

**VII - 46**

ROCHARD



Compas seul  
Compass only  
Compas sólo



**B80590**  
19 cm - 7 1/2 "

# LANDANGER

## Écarteurs valves - Retractors blades - Separadores valvulas



### ROCHARD

Valve sus-pubienne - Top pubic blade - Valvula para abajo del pubis

	P	L
<b>B80605</b>	40 mm	80 mm
<b>B80610</b>	50 mm	100 mm
<b>B80615</b>	55 mm	120 mm

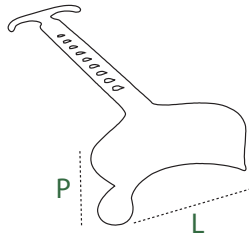

**B80605**

	P	L
<b>B80600</b>	40 mm	80 mm
<b>B80601</b>	50 mm	100 mm

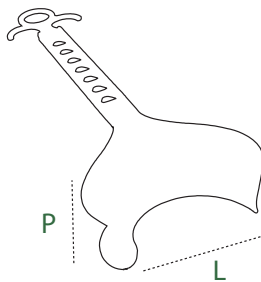

Valve radio transparente  
Radioluscent blade  
Valvulas radio transparente

**B80600**

# LANDANGER

Écarteurs valves - Retractors blades - Separadores valvulas

## DOYEN-ROCHARD



Valve sus-pubienne - Top pubic blade - Valvula para abajo del pubis

	P	L
<b>B80607</b>	45 mm	80 mm
<b>B80612</b>	50 mm	100 mm
<b>B80617</b>	65 mm	120 mm

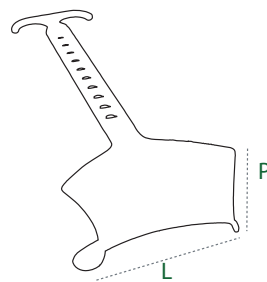

**B80607**

VII - Écarteurs  
VII - Retractors  
VII - Separadores

# LANDANGER

Écarteurs valves - Retractors blades - Separadores valvulas



**DESMARET**

	L	P
<b>B80603</b>	50-170 mm	65 mm
<b>B80604</b>	50-170 mm	45 mm

**FOUCAULT**

	L	P
<b>B806178</b>	95-120 mm	35 mm

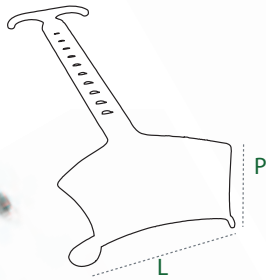
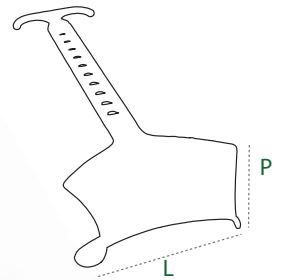

**B80603**  
43 cm - 17 "

**B806178**  
29 cm - 11 1/2 "

VII - Écarteurs  
VII - Retractors  
VII - Separadores

**VII - 50**

# LANDANGER

Écarteurs valves - Retractors blades - Separadores valvulas

3/4

HAUTEFEUILLE

TOUPET

Chaine avec curseur  
Chain with cursor  
Cadena con cursor

Chaine sans curseur  
Chain without cursor  
Cadena sin cursor

**B80618**

100 cm - 39 1/2 "

**B80835**

100 cm - 39 1/2 "

Curseur seul  
Cursor only  
Cursor sólo

**B808340**

Piquet (le jeu de 2)  
Peg (set of 2)  
Estraca (juego de 2)

**B808410**

ø 16 mm

L : 40 cm - 15 3/4 "

Piquet (le jeu de 2)  
Peg (set of 2)  
Estraca (juego de 2)

**B80840**

ø 16 mm

L : 60 cm - 23 1/2 "

Maillon rapide  
Quick ring  
Anillo rápido

**B808360**

40 mm - 1 1/2 "

VII - Écarteurs  
VII - Retractors  
VII - Separadores

# LANDANGER

## Écarteurs valves - Retractors blades - Separadores valvulas



### RICARD

Valves latérales (à l'unité)  
Lateral blades (per unit)  
Valvulas laterales (la unidad)

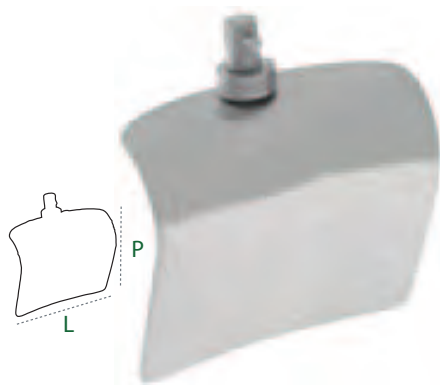

	P	L
<b>B80645</b>	50 mm	60 mm
<b>B80650</b>	65 mm	80 mm
<b>B80655</b>	80 mm	100 mm
<b>B80660</b>	100 mm	120 mm



Compas seul  
Compass only  
Compas sólo

Ouverture maxi 300mm  
Blade opening 11 3/4"  
Abertura total 300 mm

**B80640**  
18 cm - 7"

Valve médiane  
Center blade  
Valvula mediana



### TOUPET

Valves latérales (à l'unité)  
Lateral blades (per unit)  
Valvulas laterales (la unidad)



	P	L
<b>B80665</b>	50 mm	60 mm
<b>B80670</b>	65 mm	80 mm
<b>B80675</b>	80 mm	100 mm
<b>B80680</b>	100 mm	120 mm

	P	L
<b>B808086</b>	70 mm	40 mm
<b>B808087</b>	50 mm	40 mm



# LANDANGER

Écarteurs - Retractors - Separadores

RICARD



L		
60 mm	<b>B80620</b>	= B80640 + 2 x B80645 + B80665
80 mm	<b>B80625</b>	= B80640 + 2 x B80650 + B80670
100 mm	<b>B80630</b>	= B80640 + 2 x B80655 + B80675
120mm	<b>B80635</b>	= B80640 + 2 x B80660 + B80680

Complet avec 3 valves  
Complete with 3 blades  
Completo con 3 valvulas

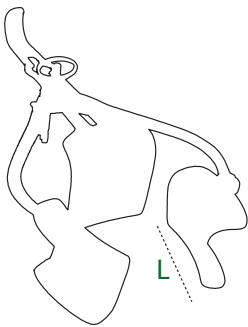

**B80620**  
60 mm

VII - Écarteurs  
VII - Retractors  
VII - Separadores

# LANDANGER

## Écarteurs valves - Retractors blades - Separadores valvulas



**RICARD-BEGOIN**

Valves latérales (à l'unité)  
Lateral blades (per unit)  
Valvulas laterales (la unidad)

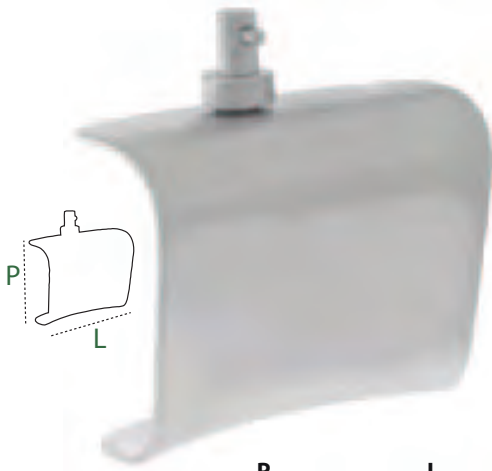

	P	L
<b>B80705</b>	50 mm	60 mm
<b>B80710</b>	70 mm	80 mm
<b>B80715</b>	75 mm	100 mm
<b>B80720</b>	95 mm	120 mm

Compas seul  
Compass only  
Compas sólo



Ouverture maxi 300 mm  
Blade opening 11 3/4 "  
Abertura total 300 mm

**B80640**  
18 cm - 7 "

Valve médiane  
Center blade  
Valvula mediana



	P	L
<b>B80725</b>	55 mm	60 mm
<b>B80730</b>	75 mm	80 mm
<b>B80735</b>	110 mm	100 mm
<b>B80740</b>	120 mm	120 mm

# LANDANGER

Écarteurs - Retractors - Separadores

## RICARD-BEGOIN



L		
60 mm	<b>B80685</b>	= B80640 + 2 x B80705 + B80725
80 mm	<b>B80690</b>	= B80640 + 2 x B80710 + B80730
100 mm	<b>B80695</b>	= B80640 + 2 x B80715 + B80735
120 mm	<b>B80700</b>	= B80640 + 2 x B80720 + B80740

Complet avec 3 valves  
Complete with 3 blades  
Completo con 3 valvulas



VII - Écarteurs  
VII - Retractors  
VII - Separadores

# LANDANGER

Écarteurs - Retractors - Separadores



## TOUPET

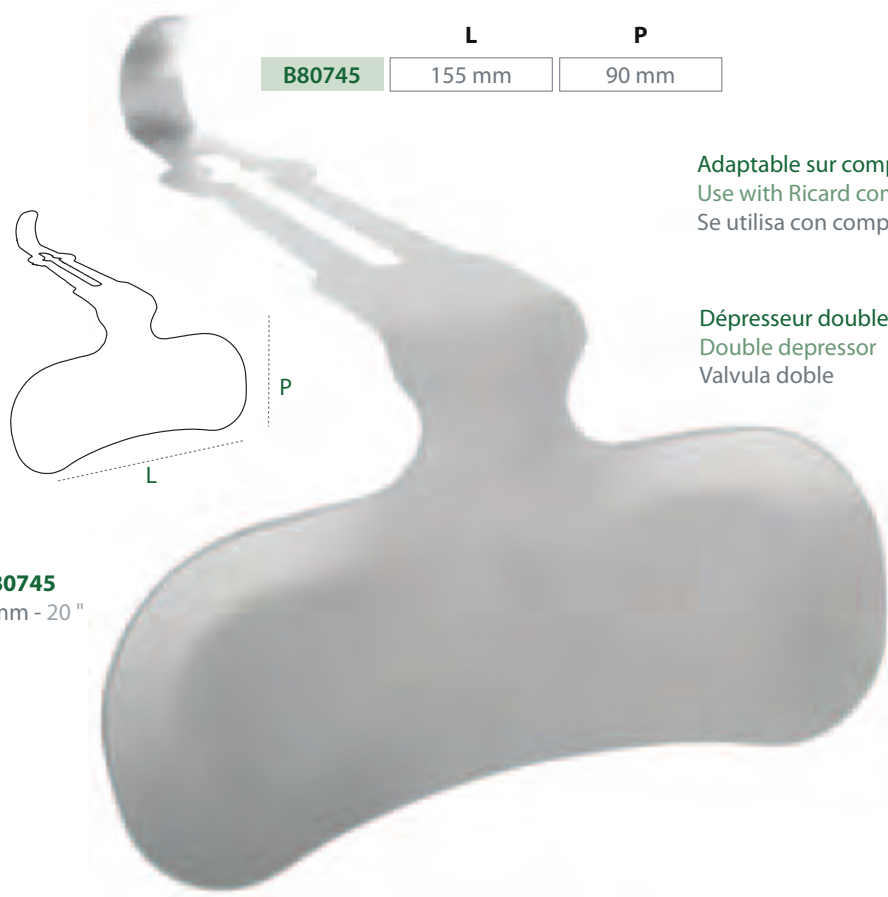

**B80745**

**L**  
155 mm

**P**  
90 mm

Adaptable sur compas de Ricard  
Use with Ricard compass  
Se utiliza con compas de Ricard

Dépresseur double  
Double depressor  
Valvula doble

**B80745**  
205 mm - 20 "

## TOUPET (ENTEROSTAT)

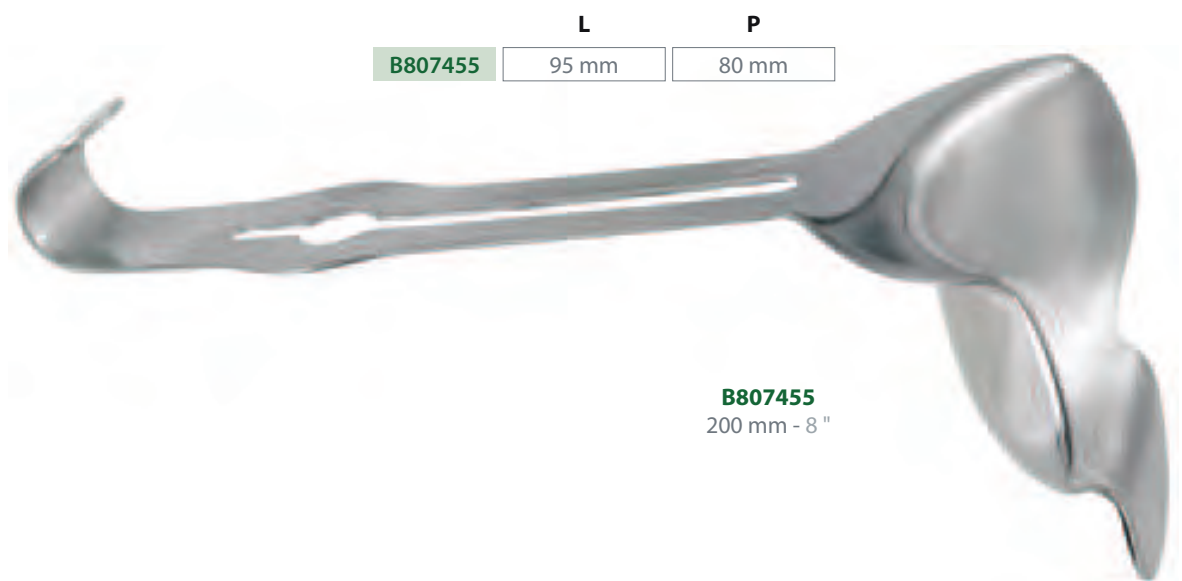

**B807455**

**L**  
95 mm

**P**  
80 mm

**B807455**  
200 mm - 8 "

# LANDANGER

## Écarteurs - Retractors - Separadores



### COTT

Valves latérales (à l'unité)  
Lateral blades (per unit)  
Valvulas laterales (la unidad)

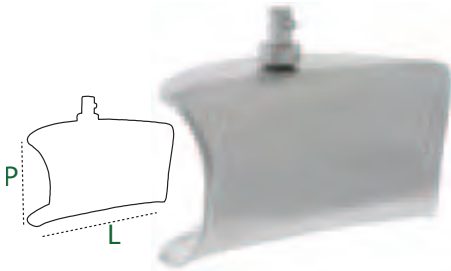

	P	L
<b>B807580</b>	40 mm	50 mm
<b>B80759</b>	45 mm	75 mm
<b>B80760</b>	55 mm	75 mm

Valve médiane  
Center blade  
Valvula mediana



	P	L
<b>B80765</b>	65 mm	75 mm



Compas seul  
Compass only  
Compas sólo

- B807610**  
20 cm - 8 "
- B807620**  
25 cm - 10 "
- B80763**  
30 cm - 11 <sup>3</sup>/<sub>4</sub> "

Complet avec 2 valves latérales et 1 valve médiane  
Complete with 2 lateral blades and 1 center blade  
Completo con 2 valvulas laterales y 1 valvula mediana

- B80755** = B80763 + 2 x B80759 + B80765
- B80756** = B80763 + 2 x B80760 + B80765
- B80750** = B80763 + 2 x B80759 + 2 x B80760 + B80765

# LANDANGER

Écarteurs - Retractors - Separadores



## PALMER

Complet avec 3 paires de valves latérales de Ricard  
 Complete with 3 pairs of Ricard lateral blades  
 Completo con 3 pares de valvulas laterales de Ricard

**B80767** = B80763 + 2 x B80645 + 2 x B80650 + 2 x B80655

Compas seul  
 Compass only  
 Compas sólo

**B80763**  
 30 cm - 11 <sup>3</sup>/<sub>4</sub> "



Valves latérales (à l'unité)  
 Lateral blades (per unit)  
 Valvulas laterales (la unidad)

	P	L
<b>B80645</b>	50 mm	60 mm
<b>B80650</b>	65 mm	80 mm
<b>B80655</b>	80 mm	100 mm

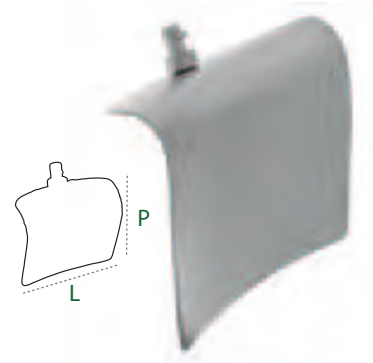

**B80655**

# LANDANGER

Écarteurs - Retractors - Separadores

OLIVIER

3/4

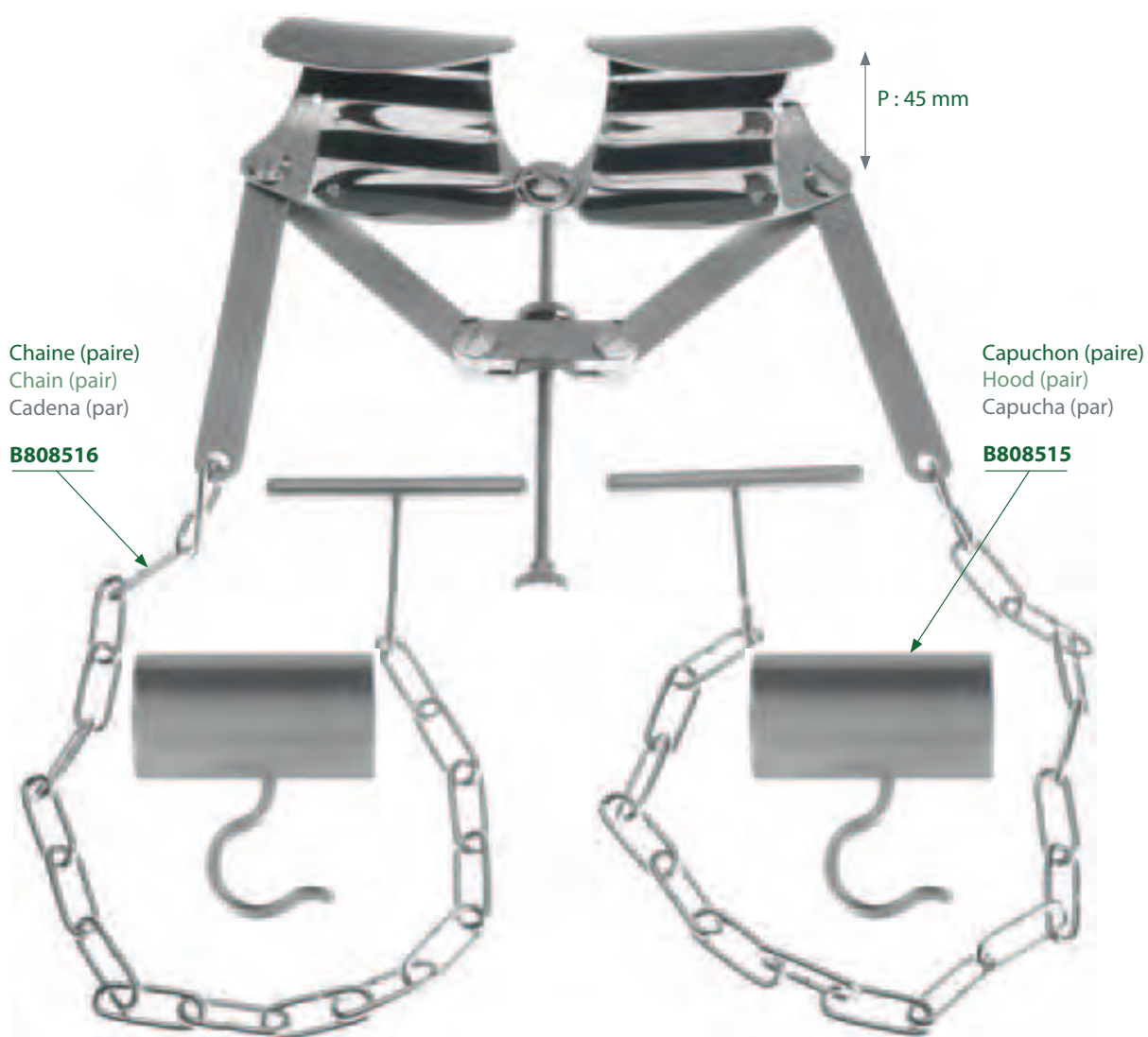

**B80850**

P : 45 mm

Écarteur complet avec chaînes et capuchons  
Complete retractor with chains and hoods  
Separadore completo con cadenas et capuchas

**B808510**

P : 107 mm

Écarteur complet avec chaînes et capuchons pour obèse  
Complete retractor with chains and hoods for obese  
Separadore completo con cadenas et capuchas por obeso

VII - Écarteurs  
VII - Retractors  
VII - Separadores

# LANDANGER

Écarteurs - Retractors - Separadores

2/3

## KIRSCHNER

Cadre fixe avec 2 paires de valves  
 Fixed frame with 2 pairs of blades  
 Cuadro fijo con 2 pares de valvulas

**B80815** = B808159 + 2 B808201 + 2 B808202



Cadre seul  
 Frame only  
 Cuadro sólo

**I**

**L**

**B808159**

250 mm

250 mm

Valves seules  
 Blades only  
 Valvulas sóloas

**P**

**L**

**B808201**

40 mm

55 mm

Étroite - Narrow - Estrecho

**B808202**

50 mm

65 mm

Large - Wide - Amplio

**B808206**

90 mm

90 mm

Extra large - Extra wide - Extra amplio

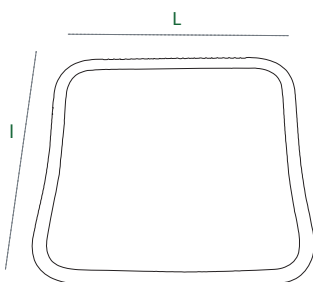

**VII - 60**

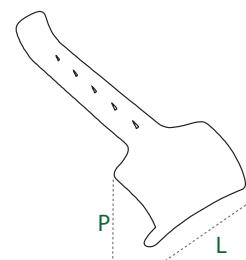



# LANDANGER

Écarteurs - Retractors - Separadores

## KIRSCHNER



Cadre pliant avec 2 paires de valves  
 Fixed frame with 2 pairs of blades  
 Cuadro fijo con 2 pares de valvulas

**B80820** = B808209 + 2 B808201 + 2 B808202



Cadre seul  
 Frame only  
 Cuadro sólo

**I**

**L**

**B808209**

250 mm

250 mm

Valves seules  
 Blades only  
 Valvulas sóloas

**P**

**L**

**B808201**

40 mm

55 mm

Etroite - Narrow - Estrecho

**B808202**

50 mm

65 mm

Large - Wide - Amplio

**B808206**

90 mm

90 mm

Extra large - Extra wide - Extra amplio

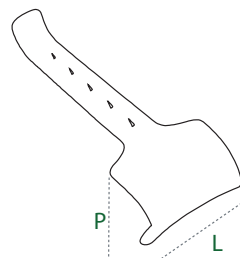
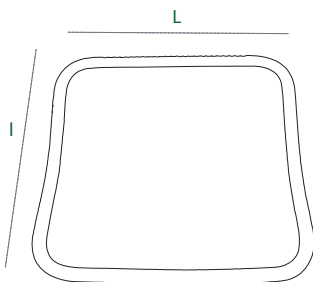

VII - Écarteurs  
 VII - Retractors  
 VII - Separadores

**VII - 61**

# LANDANGER

## Écarteurs - Retractors - Separadores



### DENIS BROWN

Cadre 178 x 140 mm complet avec 2 paires de valves  
Frame 7 " x 5 1/2 " complete with 2 pairs of blades  
Cuadro 178 x 140 mm completo con 2 pares de valvulas

**B808300** = B808310 + 2 x B808312 + 2 x B808313

Cadre 255 x 178 mm complet avec 2 paires de valves  
Frame 10 " x 7 " complete with 2 pairs of blades  
Cuadro 255 x 178 mm completo con 2 pares de valvulas

**B808301** = B808311 + 2 x B808312 + 2 x B808313



Cadre seul 178 x 140 mm  
Frame only 178 x 140 mm  
Cuadro sólo 178 x 140 mm

**B808310**

Valve seule 38 x 25 mm  
Blade only 1 1/2 " x 1 "  
Valvula sólo 38 x 25 mm

**B808312**

Cadre seul 255 x 178 mm  
Frame only 255 x 178 mm  
Cuadro sólo 255 x 178 mm

**B808311**

Valve seule 38 x 38 mm  
Blade only 1 1/2 " x 1 1/2 "  
Valvula sólo 38 x 38 mm

**B808313**

### VERWINYL

Radio transparent complet avec 2 paires de valves  
 Transparent to X ray complete with 2 pair of blades  
 Transparente a los rayos-X completo con 2 pares de valvulas

**B80822** = B808221 + 2 x B80823 + 2 x B80824

Cadre seul  
 Frame only  
 Cuadro sólo

**B808221**

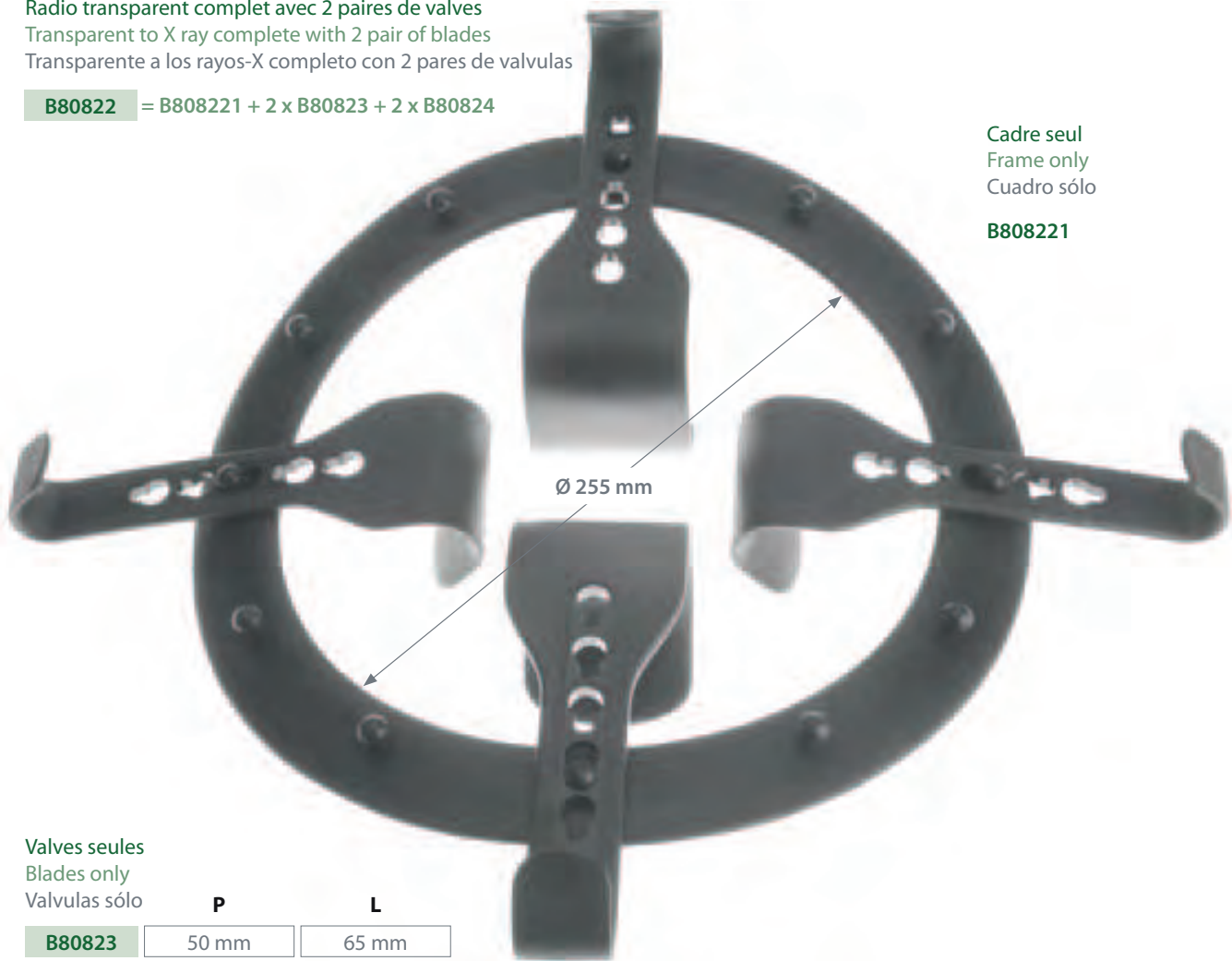

Valves seules  
 Blades only  
 Valvulas sólo

	P	L
<b>B80823</b>	50 mm	65 mm
<b>B80824</b>	75 mm	65 mm

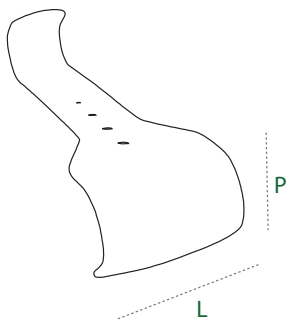

Bouton  
 Knob  
 Botón

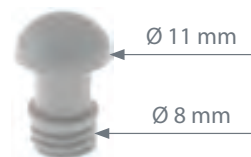

**B80826**

# LANDANGER

Écarteurs - Retractors - Separadores

## AUVERT

Complet - Complete - Completo

**B80810** = B808110 + 8 x B80812 + 8 x B80813 + B808133 + B808134 + B808135  
+ B808136 + 2 x B808137 + 2 x B808138 + 2 x B808139

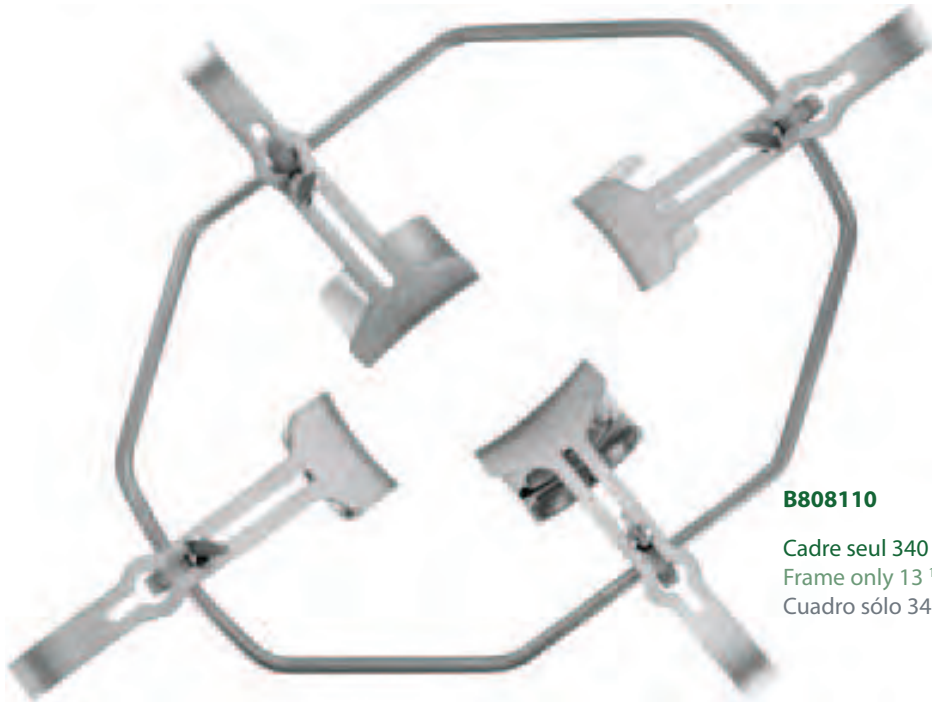

**B80813**

Vis anneau seule  
Ring screw only  
Tornillo anillo sólo



**B80812**

Étau seul  
Vice only  
Torno sólo

**B808110**

Cadre seul 340 x 260 mm  
Frame only 13 1/2 " x 10 1/4 "  
Cuadro sólo 340 x 260 mm



**B808135**

19,5 cm - 7 3/4 "

Valves recourbées  
Curved blades  
Valvulas curvas

**P** **L**

<b>B808135</b>	30 mm	60 mm
<b>B808133</b>	50 mm	80 mm

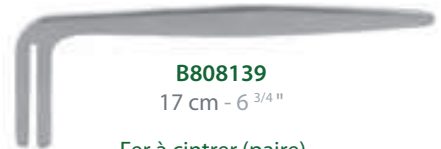

**B808139**

17 cm - 6 3/4 "

Fer à cintrer (paire)  
Blade bender (pair)  
Llave para valvula (par)

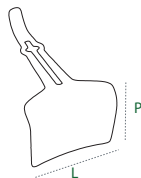

**B808136**

18,5 cm - 7 1/4 "

Valves obliques  
Oblic blades  
Valvulas oblicuos

**P** **L**

<b>B808134</b>	50 mm	60 mm
<b>B808136</b>	65 mm	80 mm



**B808138**

32,5 cm - 12 3/4 "

Valves malléables  
Malleable blades  
Valvulas maleables

**L**

<b>B808137</b>	35 mm
<b>B808138</b>	50 mm

# LANDANGER

Écarteurs - Retractors - Separadores

## GOSSET



1 branche mobile  
1 mobile arm  
1 brazo móvil

	O	P	L
<b>B80470</b>	120 mm	35 mm	30 mm
<b>B80475</b>	180 mm	60 mm	45 mm
<b>B80476</b>	280 mm	60 mm	45 mm
<b>B804770</b>	300 mm	120 mm	100 mm

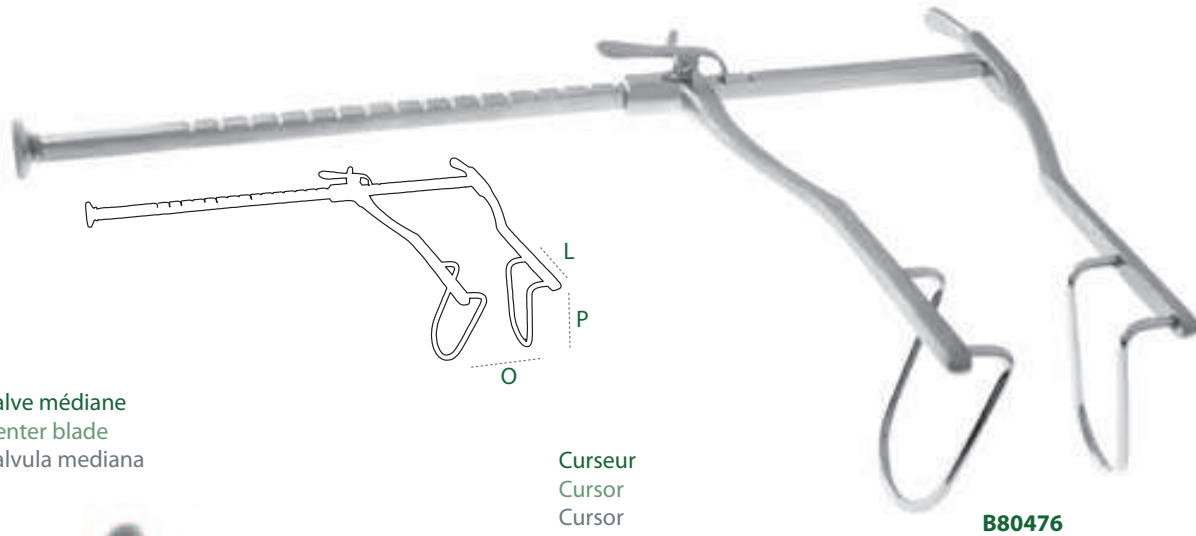

**B80476**

Valve médiane  
Center blade  
Valvula mediana

Curseur  
Cursor  
Cursor

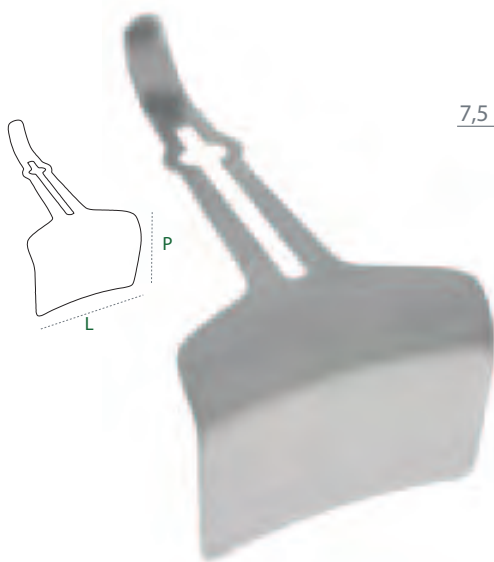

**B80500**

## MONTESTRUC



**B804770**

	P	L
<b>B80498</b>	65 mm	85 mm

O : Ouverture - Blades opening - Abertura de las hojas  
P : Profondeur - Depth - Profundidad  
L : Largeur - Width - Anchura

VII - Écarteurs  
VII - Retractors  
VII - Separadores

# LANDANGER

Écarteurs - Retractors - Separadores



## GOSSET

1 branche mobile

1 mobile arm

1 brazo móvil

	O	P	L
<b>B80486</b>	75 mm	25 mm	22 mm
<b>B80488</b>	120 mm	35 mm	30 mm
<b>B804900</b>	180 mm	60 mm	45 mm
<b>B80494</b>	280 mm	60 mm	45 mm

2 branches mobiles

2 mobile arms

2 brazos móviles

	O	P	L
<b>B80496</b>	260 mm	60 mm	45 mm

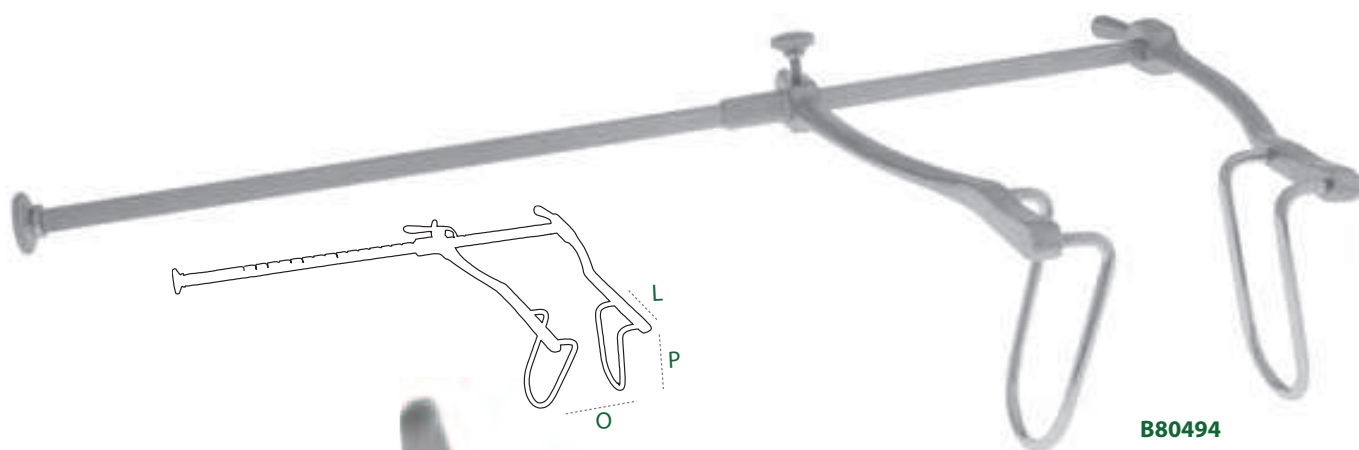

**B80494**

Valve médiane  
Center blade  
Valvula mediana

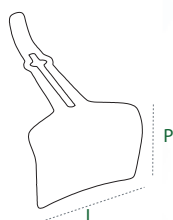

P L

<b>B80498</b>	65 mm	85 mm
---------------	-------	-------

Curseur  
Cursor  
Cursor



**B80500**

VII - Écarteurs  
VII - Retractors  
VII - Separadores

O : Ouverture - Blades opening - Abertura de las hojas

P : Profondeur - Depth - Profundidad

L : Largeur - Width - Anchura

# LANDANGER

## Écarteurs - Retractors - Separadores

### BALFOUR



Complet  
Complete  
Completo

	O	P	L
<b>B80483</b>	160 mm	65 mm	35 mm
<b>B80484</b>	250 mm	90 mm	35 mm

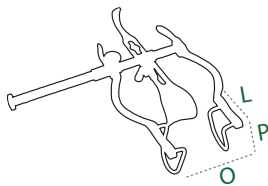

Valve médiane seule  
Center blade only  
Valvula mediana sóla

	P	L
<b>B804832</b>	50 mm	80 mm
<b>B804842</b>	70 mm	85 mm

### BALFOUR-BABY

Complet  
Complete  
Completo

	O	P	L
<b>B80482</b>	90 mm	27 mm	25 mm

Valve médiane seule  
Center blade only  
Valvula mediana sóla

	P	L
<b>B804822</b>	25 mm	25 mm



O : Ouverture - Blades opening - Abertura de las hojas  
P : Profondeur - Depth - Profundidad  
L : Largeur - Width - Anchura

# LANDANGER

## Écarteurs - Retractors - Separadores



### HRYNTSCHAK

Complet  
Complete  
Completo

	O	P	L
<b>B80505</b>	115 mm	80 mm	35 mm

Valve médiane seule  
Center blade only  
Valvula mediana sóla

	P	L
<b>B80507</b>	90 mm	40 mm

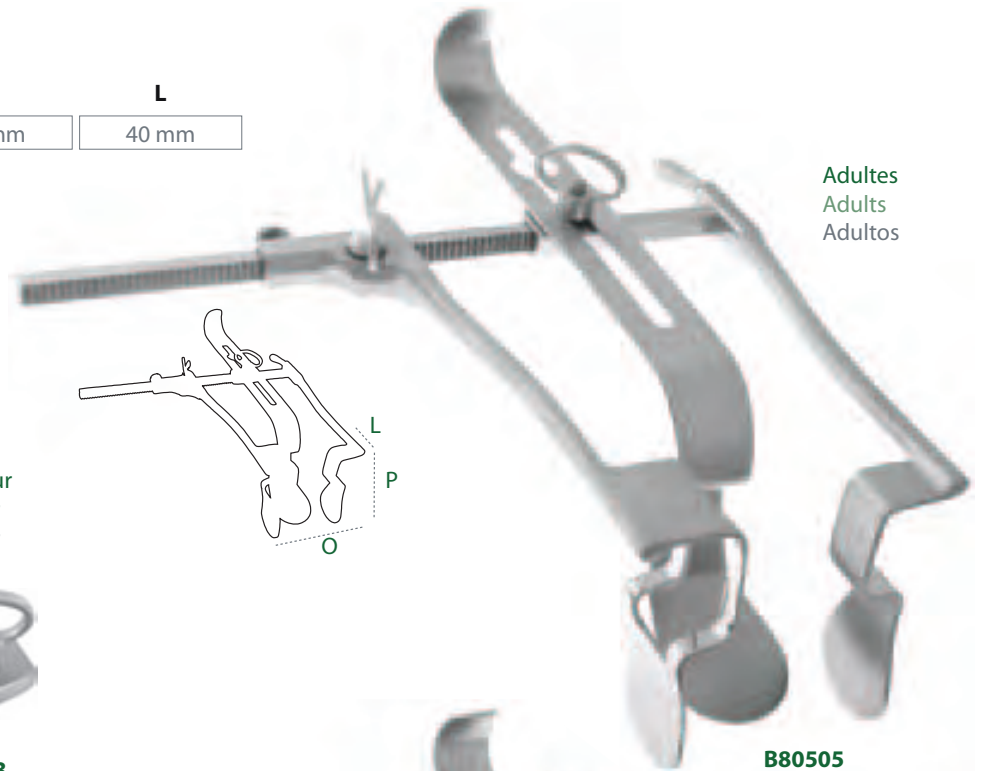

Adultes  
Adults  
Adultos

Curseur  
Cursor  
Cursor



**B80513**

**B80505**

Complet  
Complete  
Completo

	O	P	L
<b>B80509</b>	85 mm	45 mm	18 mm

Valve médiane seule  
Center blade only  
Valvula mediana sóla

	P	L
<b>B80511</b>	60 mm	25 mm

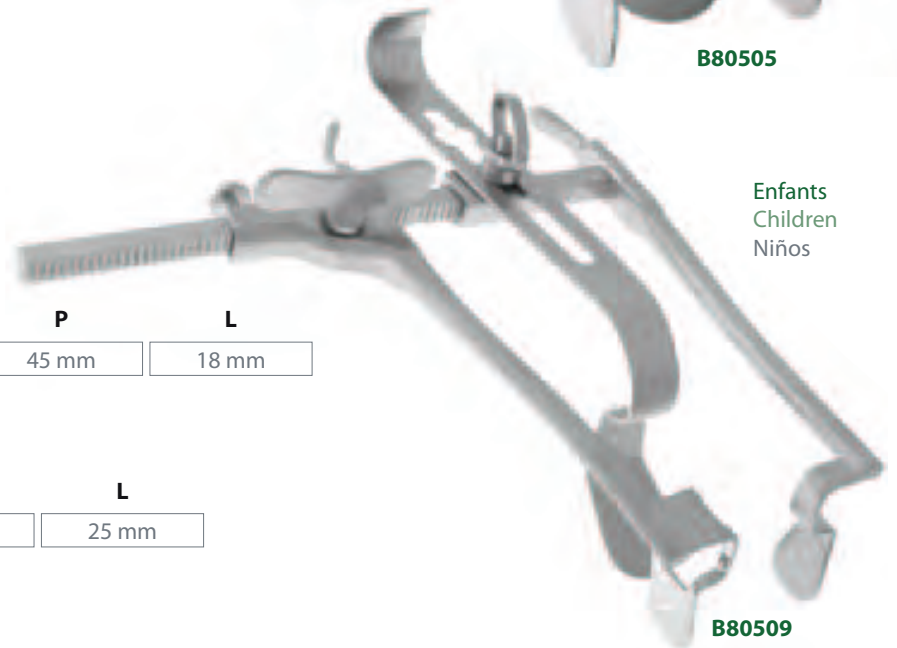

Enfants  
Children  
Niños

**B80509**

O : Ouverture - Blades opening - Abertura de las hojas  
P : Profondeur - Depth - Profundidad  
L : Largeur - Width - Anchura



# LANDANGER

Écarteurs - Retractors - Separadores

ABADIE



	O	P	L
<b>B80502</b>	85 mm	22 mm	31 mm

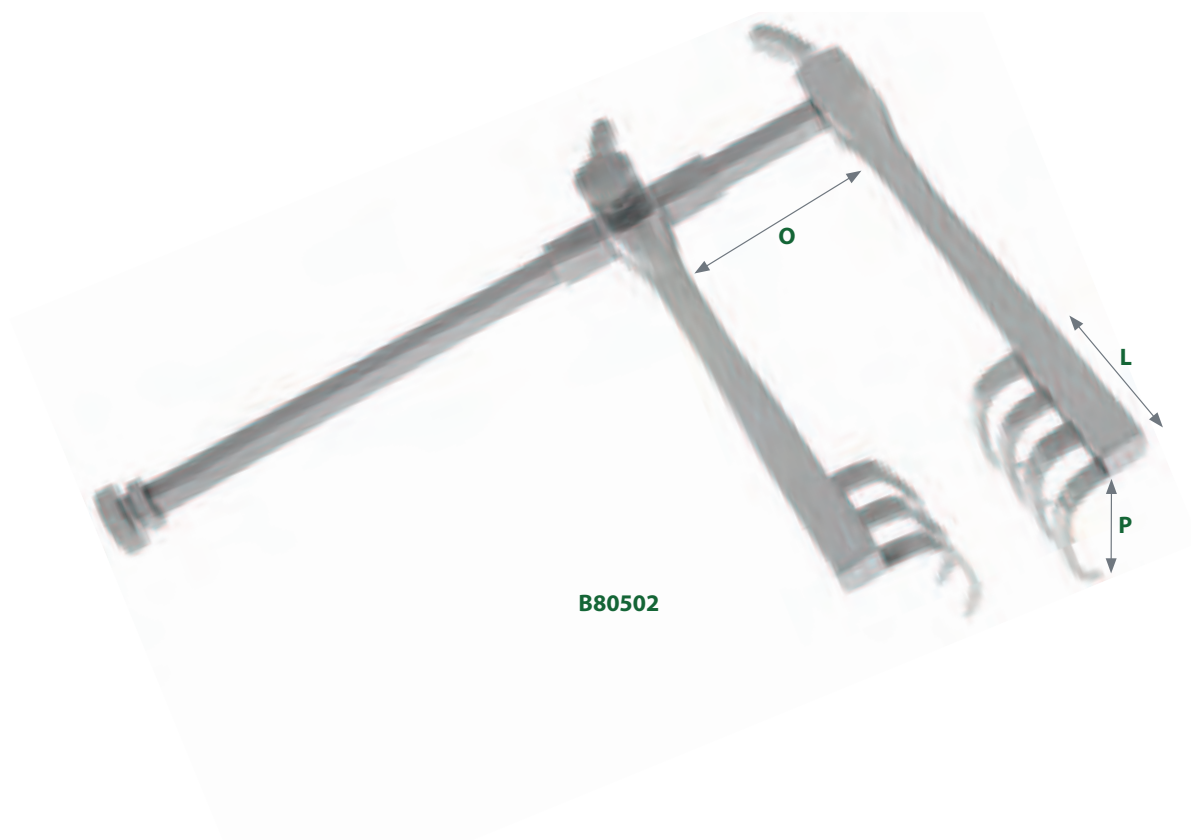

O : Ouverture - Blades opening - Abertura de las hojas  
P : Profondeur - Depth - Profundidad  
L : Largeur - Width - Anchura

**DARTIGUES  
(Laparostat)**



VII - Écarteurs  
VII - Retractors  
VII - Separadores

**B80450**  
29 cm - 11 1/2 "

**B80455**  
32 cm - 12 1/2 "

**VII - 70**

# LANDANGER

## Écarteurs - Retractors - Separadores

### FINOCHIETTO



		O	P	L
Nourrissons Infants Niños de pecho	<b>B80770</b>	75 mm	20 mm	45 mm
Enfants Children Niños	<b>B80775</b>	165 mm	45 mm	45 mm
Adultes Adults Adultos	<b>B80780</b>	200 mm	65 mm	45 mm

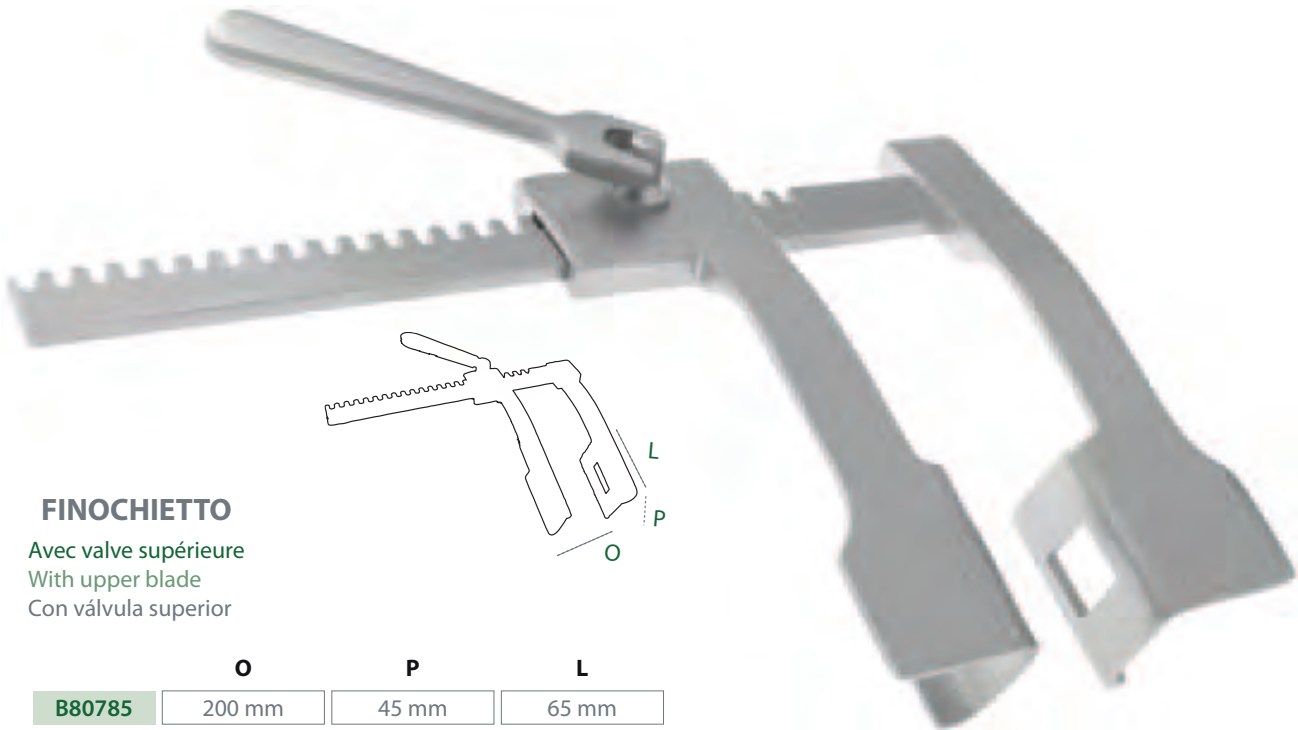

**B80775**

### FINOCHIETTO

Avec valve supérieure  
With upper blade  
Con válvula superior

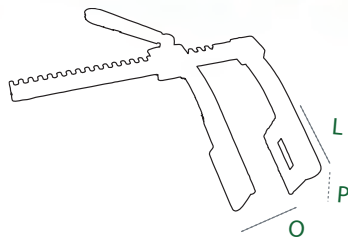

	O	P	L
<b>B80785</b>	200 mm	45 mm	65 mm

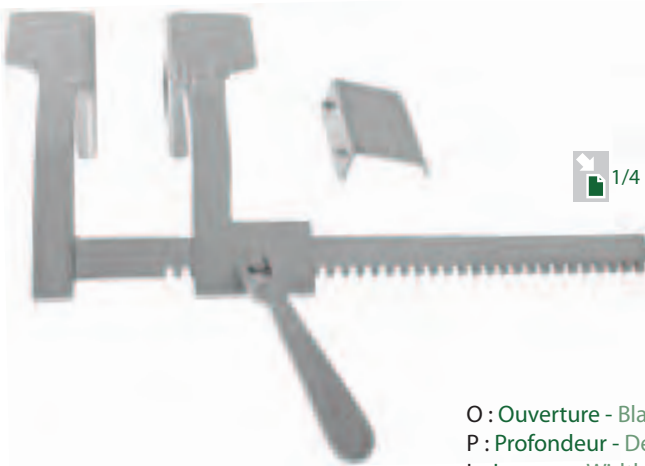

O : Ouverture - Blades opening - Abertura de las hojas  
P : Profondeur - Depth - Profundidad  
L : Largeur - Width - Anchura

# LANDANGER

Écarteurs - Retractors - Separadores



## FINOCHIETTO

Complet avec 3 paires de valves  
 Complete with 3 pairs of blades  
 Completo con 3 pares de valvulas

O

**B80790** 200 mm

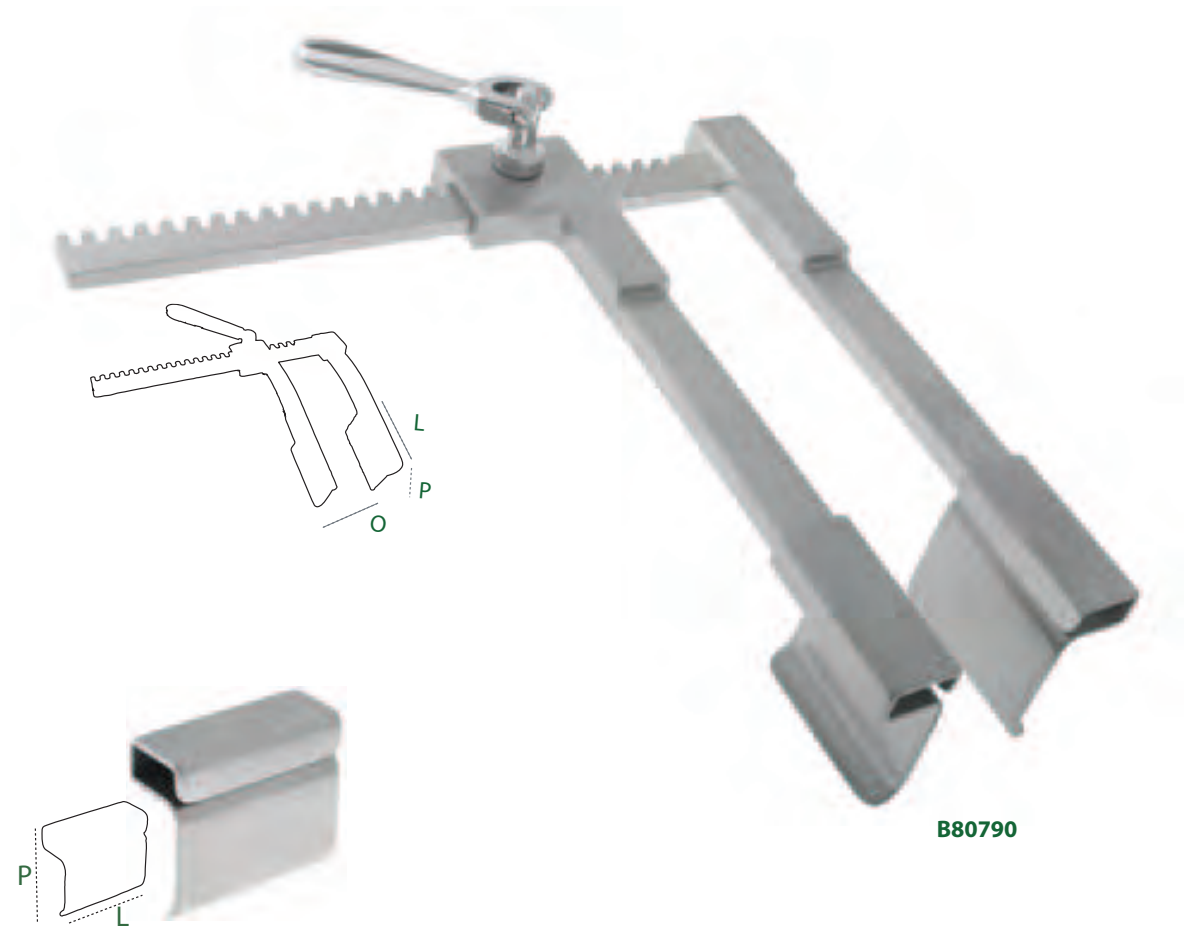

**B80790**

P	L
45 mm	40 mm
40 mm	60 mm
50 mm	60 mm

VII - Écarteurs  
 VII - Retractors  
 VII - Separadores

O : Ouverture - Blades opening - Abertura de las hojas  
 P : Profondeur - Depth - Profundidad  
 L : Largeur - Width - Anchura

# LANDANGER

Écarteurs - Retractors - Separadores



## FINOCHIETTO

Modèle Landanger complet avec 3 paires de valves  
 Complete Landanger model with 3 pairs of blades  
 Modelo Landanger completo con 3 pares de valvulas

O

B80792

250 mm

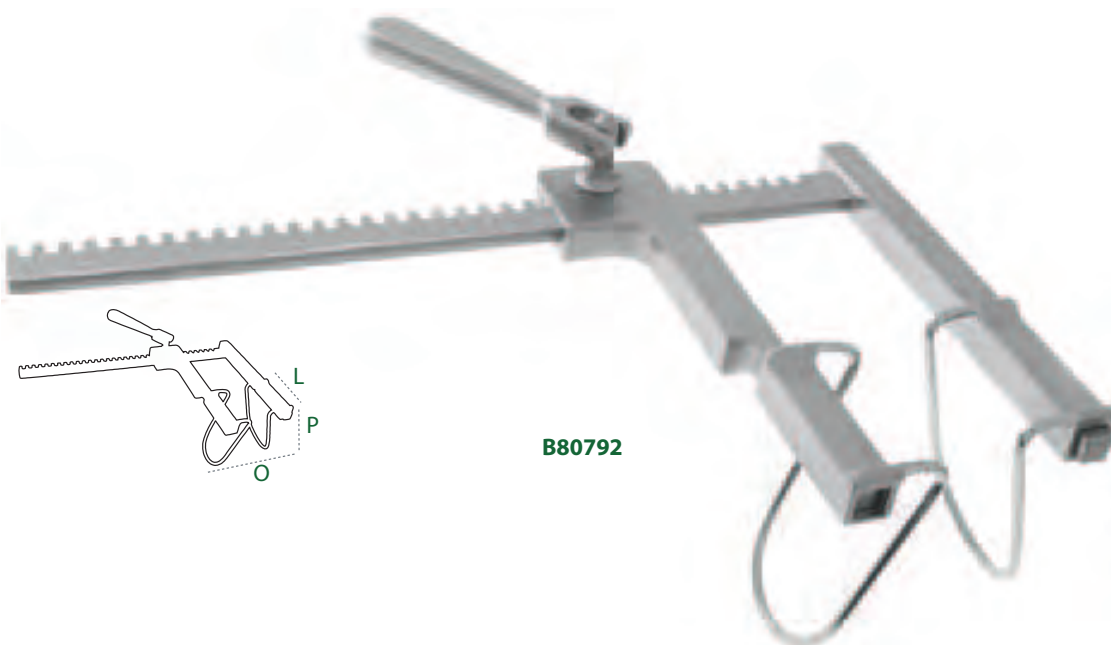

B80792

Valve genre Gosset  
 Gosset blade  
 Valvula tipo Gosset

Valve thoracique  
 Thoracic blade  
 Valvula toracica

Valve abdominale  
 Abdominal blade  
 Valvula abdominale



P

L

80 mm

60 mm

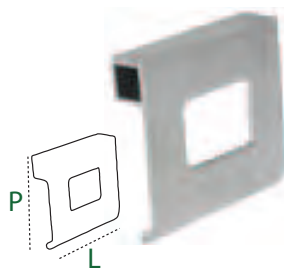

P

L

P

L

60 mm

60 mm

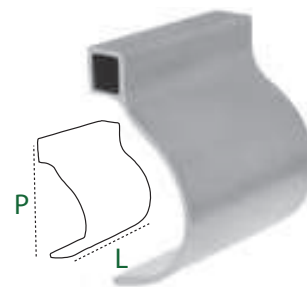

P

L

P

L

75 mm

60 mm

O : Ouverture - Blades opening - Abertura de las hojas  
 P : Profondeur - Depth - Profundidad  
 L : Largeur - Width - Anchura

# LANDANGER

Écarteurs - Retractors - Separadores



## FINOCHIETTO ALU

	O	P	L
Nourrissons Infants Niños de pecho	<b>B80890</b> 100 mm	31 mm	31 mm
Enfants Children Niños	<b>B80895</b> 150 mm	38 mm	44 mm
Adultes Adults Adultos	<b>B80900</b> 180 mm	52 mm	62 mm

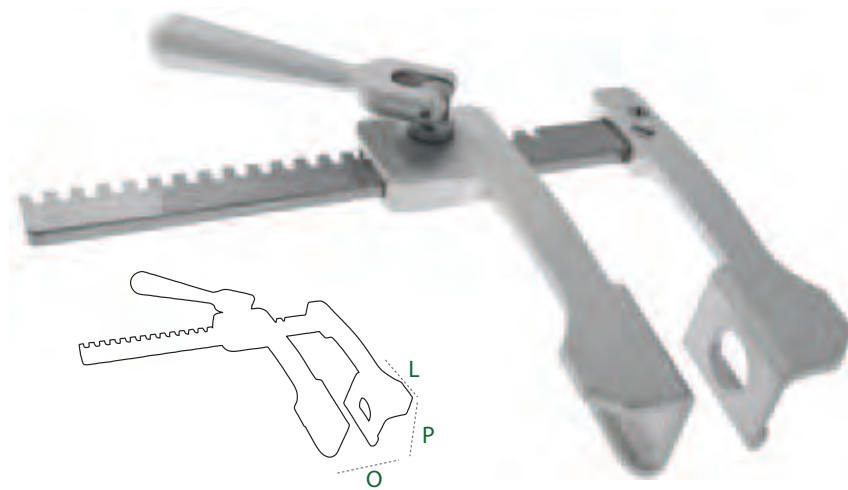

**B80895**

O : Ouverture - Blades opening - Abertura de las hojas  
P : Profondeur - Depth - Profundidad  
L : Largeur - Width - Anchura

# LANDANGER

Écarteurs - Retractors - Separadores

DUBOST



Complet avec 2 paires de valves (35 et 45 mm)  
 Complete with 2 pairs of blades (35 and 45 mm)  
 Completo con 2 pares de valvulas (35 y 45 mm)

O

**B80794** 250 mm

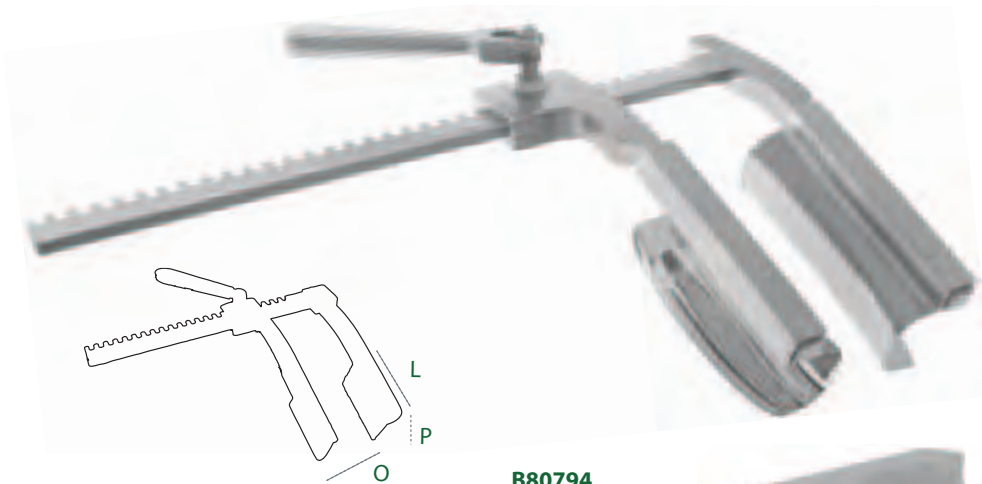

**B80794**

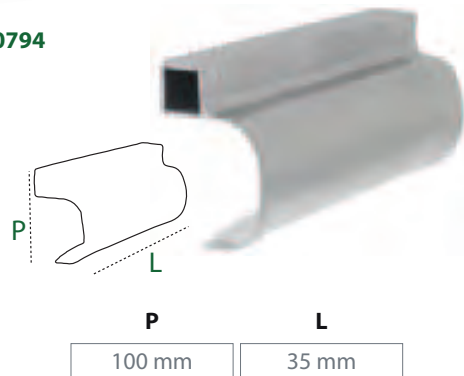

Valves complémentaires seules (paire)  
 Additional blades only (pair)  
 Válvulas adicional sólas (par)

**P** 100 mm **L** 35 mm

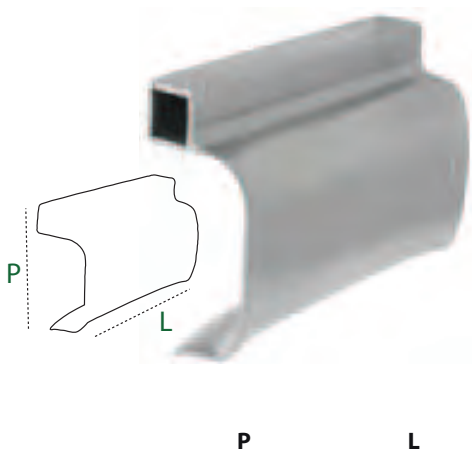

**B807942** **P** 100 mm **L** 55 mm

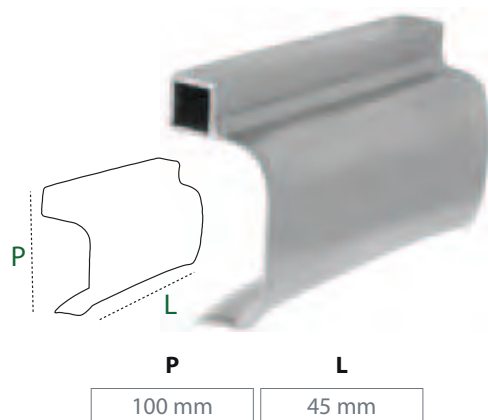

**P** 100 mm **L** 45 mm

O : Ouverture - Blades opening - Abertura de las hojas  
 P : Profondeur - Depth - Profundidad  
 L : Largeur - Width - Anchura

VII - Écarteurs  
 VII - Retractors  
 VII - Separadores

# LANDANGER

Écarteurs - Retractors - Separadores

3/4

## BAILLEY

Rapprocheur de cotes  
Rib contractor  
Contractor de costillas



**B80800**  
20 cm - 8 "

## TUFFIER

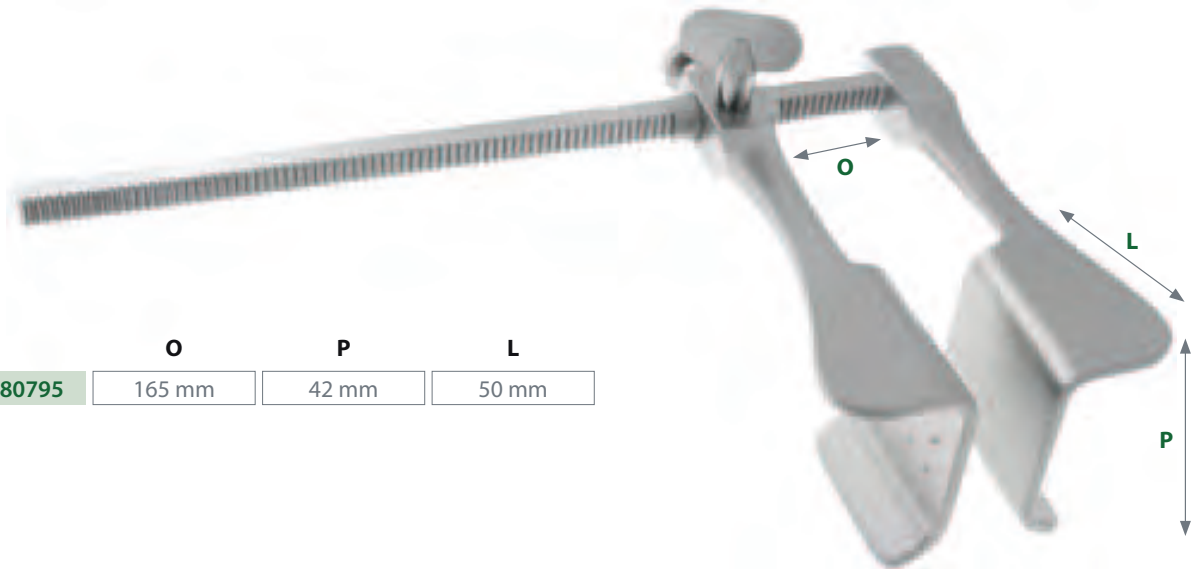

	O	P	L
<b>B80795</b>	165 mm	42 mm	50 mm

**B80795**

VII - Écarteurs  
VII - Retractors  
VII - Separadores

O : Ouverture - Blades opening - Abertura de las hojas  
P : Profondeur - Depth - Profundidad  
L : Largeur - Width - Anchura



# LANDANGER

## Écarteurs - Retractors - Separadores



### ALM

Pointu  
Sharp  
Agudo

Mousse  
Blunt  
Romo

7 cm - 2 3/4 "

**B802912**   **B802913**

10 cm - 4 "

**B802914**   **B802915**



**B802912**

### FINSEN

Pointu  
Sharp  
Agudo



**B80295**  
5 cm - 2 "

**B80300**  
7 cm - 2 3/4 "

### HEISS (HOLZEIMER)

Mousse  
Blunt  
Romo



**B80320**  
10 cm - 4 "

### JANSEN



**B80290**

Pointu  
Sharp  
Agudo

**B80290**  
10,5 cm - 4 1/4 "

Mousse  
Blunt  
Romo

**B802901**  
10,5 cm - 4 1/4 "

# LANDANGER

Écarteurs - Retractors - Separadores



## WEITLANER

Pointu      Mousse  
Sharp      Blunt  
Agudo      Romo

10,5 cm - 4 1/8 "

**B80525**

**B805251**

13 cm - 5 "

**B80530**

**B805301**



**B80525**

10,5 cm - 4 1/8 "



**B80530**

13 cm - 5 "

VII - Écarteurs  
VII - Retractors  
VII - Separadores

**VII - 78**

### WEITLANER

Pointu	Mousse
Sharp	Blunt
Agudo	Romo

17 cm - 6 <sup>3</sup> / <sub>4</sub> "	<b>B80535</b>	<b>B805351</b>
20 cm - 8 "	<b>B80537</b>	<b>B805371</b>



# LANDANGER

Écarteurs - Retractors - Separadores



## HENLEY

Pointu  
Sharp  
Agudo

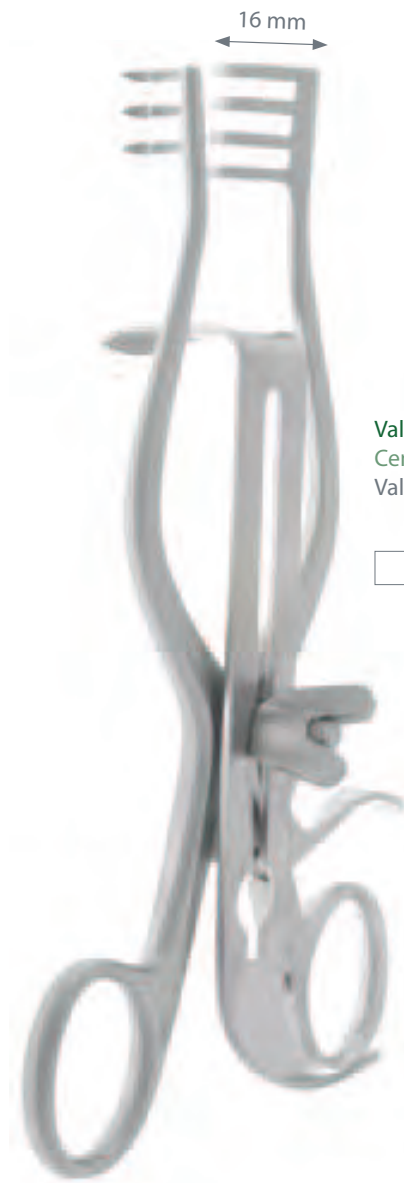

Valve médiane  
Center blade  
Valvula mediana

P	L
16 mm	25 mm

**B80542**

16,5cm - 6 1/2 "

MAC KEE



Pointu  
Sharp  
Agudo

**J52180**  
28 cm - 11 "

# LANDANGER

Écarteurs - Retractors - Separadores



## BECKMANN CONE

## BECKMANN

Mousse  
Blunt  
Romo



**B80543**  
14 cm - 5 1/2 "



**B80544**  
14 cm - 5 1/2 "

# LANDANGER

Écarteurs - Retractors - Separadores



## BECKMANN CONE

## BECKMANN

Mousse  
Blunt  
Romo



**B80545**  
17cm - 6 <sup>3</sup>/<sub>4</sub> "



**B80546**  
17 cm - 6 <sup>3</sup>/<sub>4</sub> "

VII - Écarteurs  
VII - Retractors  
VII - Separadores

# LANDANGER

Écarteurs - Retractors - Separadores



BECKMANN CONE

BECKMANN

Mousse  
Blunt  
Romo



VII - Écarteurs  
VII - Retractors  
VII - Separadores

VII - 84



### BECKMANN



Mousse  
Blunt  
Romo

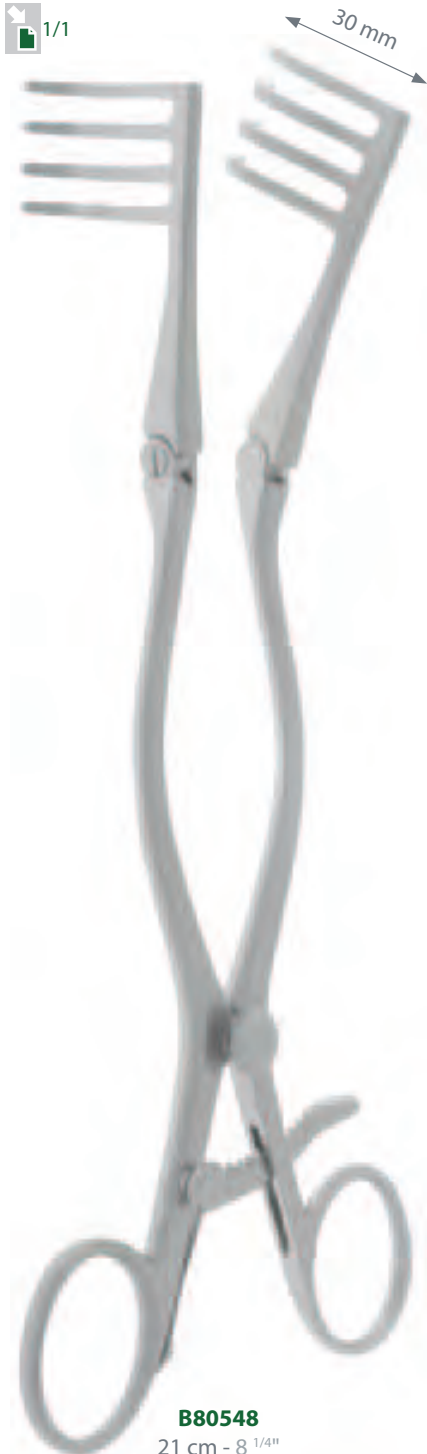

**B80548**  
21 cm - 8 1/4"



**B80566**  
30 cm - 11 3/4 "

	P
<b>B80556</b>	20 mm
<b>B80561</b>	30 mm
<b>B80566</b>	50 mm

# LANDANGER

## Écarteurs - Retractors - Separadores

1/1

### BECKMANN



Mousse  
Blunt  
Romo

Valves interchangeable (paire)  
Exchangeable blades (pair)  
Valvulas intercambiables (par)

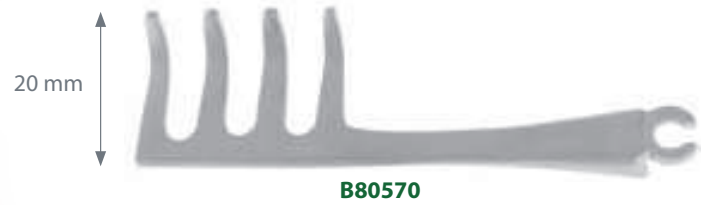

VII - Écarteurs  
VII - Retractors  
VII - Separadores

**VII - 86**

Valves interchangeables pour Beckmann B80568 (paire)  
Exchangeable blades for Beckmann B80568 (pair)  
Valvulas intercambiables para Beckmann B80568 (par)

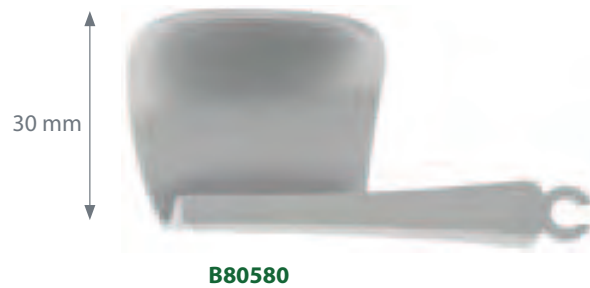

# LANDANGER

Écarteurs - Retractors - Separadores

3/4

DECOULX



Griffes rondes  
Round teeth  
Dientes redondos

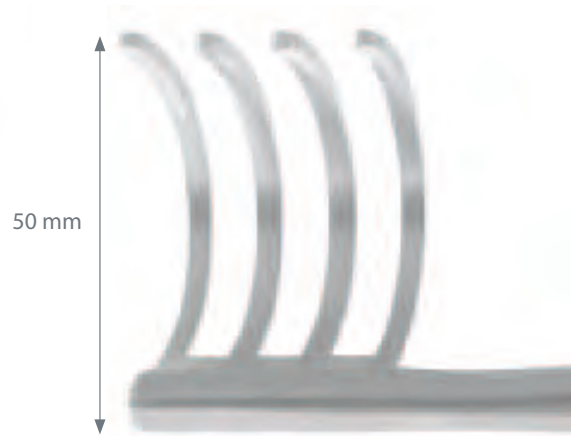

B80586

Griffes carrées  
Square teeth  
Dientes cuadradas



B80588

B80588  
33 cm - 13 "

VII - Écarteurs  
VII - Retractors  
VII - Separadores

VII - 88

# LANDANGER

Écarteurs - Retractors - Separadores



JOLL

Pour goître  
For goitre  
Para bocio



**B80845**  
14,5 cm - 5 <sup>3</sup>/<sub>4</sub> "

GELPY



**B80855**  
19 cm - 7 <sup>1</sup>/<sub>2</sub> "

VII - Écarteurs  
VII - Retractors  
VII - Separadores

# LANDANGER

Écarteurs neuro - Neuro retractors - Separadores neuro



WEITLANER

WEITLANER  
WULLSTEIN

Courbe (dos d'âne) - Curved (back ass) - Curva (a bombado)

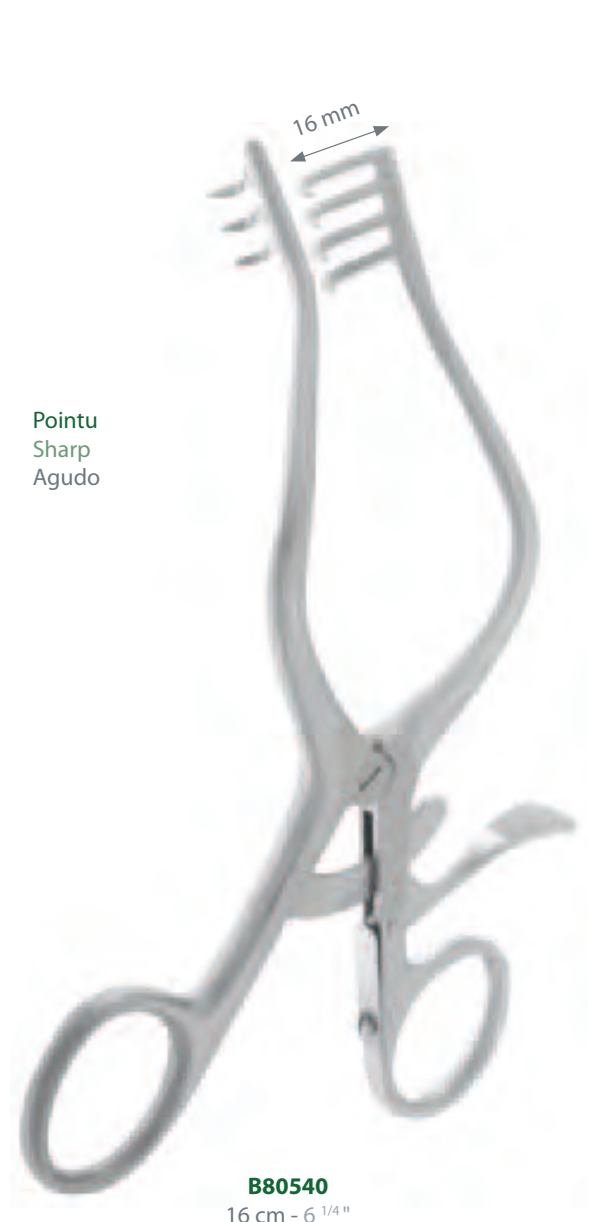

Pointu  
Sharp  
Agudo

VII - Écarteurs  
VII - Retractors  
VII - Separadores

**WEITLANER  
NEURO**

Courbe (dos d'âne) - Curved (back ass) - Curva (a bombado)



# LANDANGER

Écarteurs neuro - Neuro retractors - Separadores neuro



## MARKHAM-MEYERDING

Valve à gauche  
Blade on the left side  
Valvula a la izquierda



**B808570**  
18 cm - 7 "

Valve à droite  
Blade on the right side  
Valvula a la derecha



**B808571**  
18 cm - 7 "



# LANDANGER

Écarteurs neuro - Neuro retractors - Separadores neuro



## WALTON

Pour hémilaminectomie - For hemilaminectomy - Para hémilaminectomia



VII - Écarteurs  
VII - Retractors  
VII - Separadores

VII - 93

# LANDANGER

## Écarteurs neuro - Neuro retractors - Separadores neuro

3/4

### ADSON

#### B80870

2 x 6 griffes 32 mm  
2 x 6 teeth 32 mm  
2 x 6 dientes 32 mm

#### B80874

6 griffes courtes 13 mm à gauche  
6 short teeth 13 mm on the left side  
6 dientes cortos 13 mm a la izquierda

#### B80878

6 griffes courtes 13 mm à droite  
6 short teeth 13 mm on the right side  
6 dientes cortos 13 mm a la derecha



**B80874**  
27 cm - 10 1/2 "

# LANDANGER

Écarteurs neuro - Neuro retractors - Separadores neuro

 3/4

## INGE-MEHARY

 1/1

Écartement 38 mm  
Blades opening 38 mm  
Abertura 38 mm



**J52190**  
16 cm - 6 1/4 "

Écartement 50 mm  
Blades opening 50 mm  
Abertura 50 mm



**J52200**  
28 cm - 11 "

VII - Écarteurs  
VII - Retractors  
VII - Separadores

**VII - 95**

# LANDANGER

Écarteurs neuro - Neuro retractors - Separadores neuro



## CLOWARD

Écartement 15 mm  
Blades opening 15 mm  
Abertura 15 mm



VII - Écarteurs  
VII - Retractors  
VII - Separadores

**VII - 96**

**J52205**  
16 cm - 6 1/4 "

# LANDANGER

Écarteurs neuro - Neuro retractors - Separadores neuro



## CLOWARD



**J538209**  
9 cm - 3 1/2"

**J538211**  
11 cm - 4 1/4"

VII - Écarteurs  
VII - Retractors  
VII - Separadores

**VII - 97**

# LANDANGER

## Écarteurs neuro - Neuro retractors - Separadores neuro



### CLOWARD



Écarteur seul  
Retractor only  
Separador sólo



Valves seules  
Blades only  
Valvulas sólas

A griffes  
With teeth  
Con dientes

Sans griffes  
Without teeth  
Sin dientes

**J538040**

15 x 40 mm

**J538140**

**J538045**

15 x 45 mm

**J538145**

**J538050**

15 x 50 mm

**J538150**

**J538055**

15 x 55 mm

**J538155**

**J538060**

15 x 60 mm

**J538160**



**J538050**



**J538150**



## BUCK GRAMCKO

Leviers pour os du pied et de la main  
 Bone levers for foot and hand bones  
 Elevadores para huesos del pie y de la mano

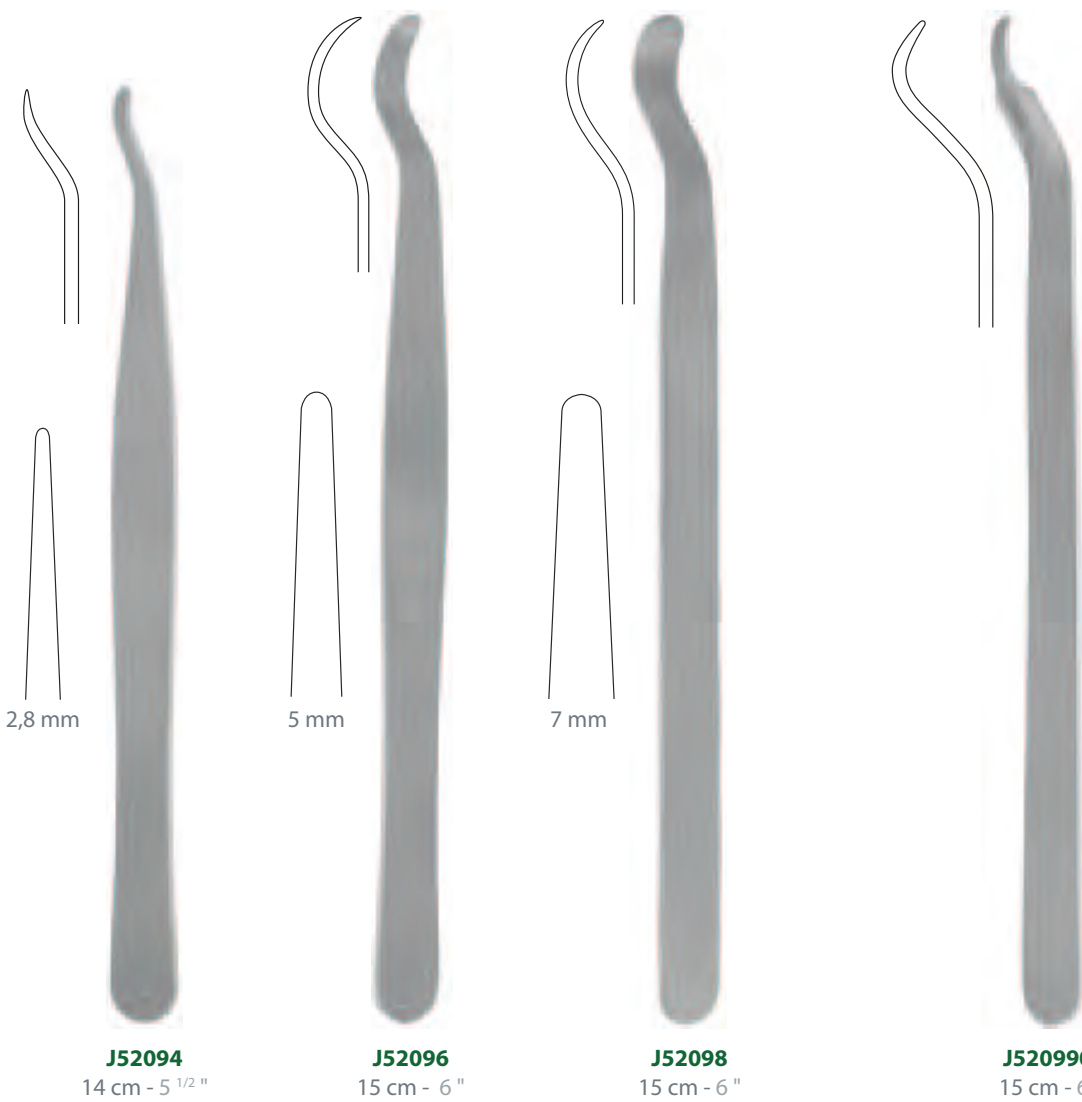

VII - Écarteurs  
 VII - Retractors  
 VII - Separadores

# LANDANGER

Instrumentation osseuse écarteurs - Osseous instrumentation retractors - Instrumentación osea separadores



## LANGE-HOHMANN



**J52072**  
16 cm - 6 1/4 "



**J52074**  
16 cm - 6 1/4 "

VII - Écarteurs  
VII - Retractors  
VII - Separadores

**VII - 100**



# LANDANGER

Instrumentation osseuse écarteurs - Osseous instrumentation retractors - Instrumentación osea separadores

## LANGE-HOHMANN

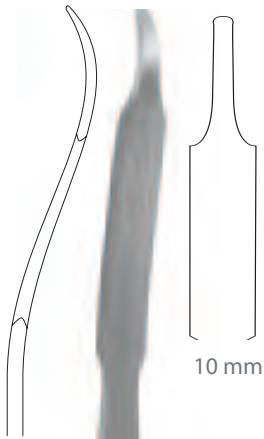

10 mm

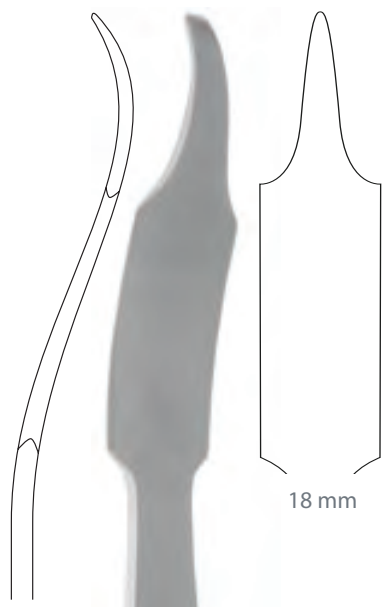

18 mm

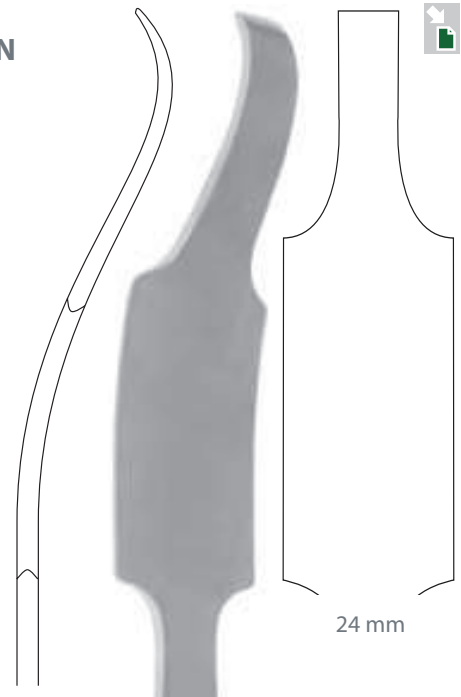

24 mm



**J52076**  
22 cm - 8 3/4 "



**J52078**  
24 cm - 9 1/2 "



**J52082**  
26 cm - 10 1/4 "

VII - Écarteurs  
VII - Retractors  
VII - Separadores

# LANDANGER

Instrumentation osseuse écarteurs - Osseous instrumentation retractors - Instrumentación osea separadores

3/4

## LANGE-HOHMANN

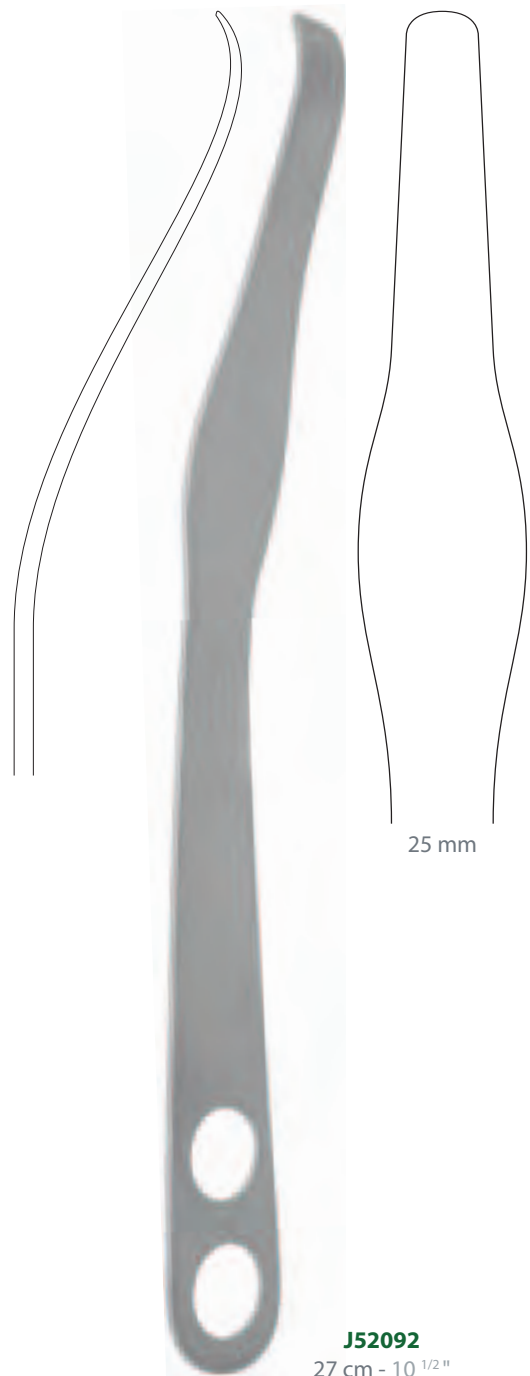
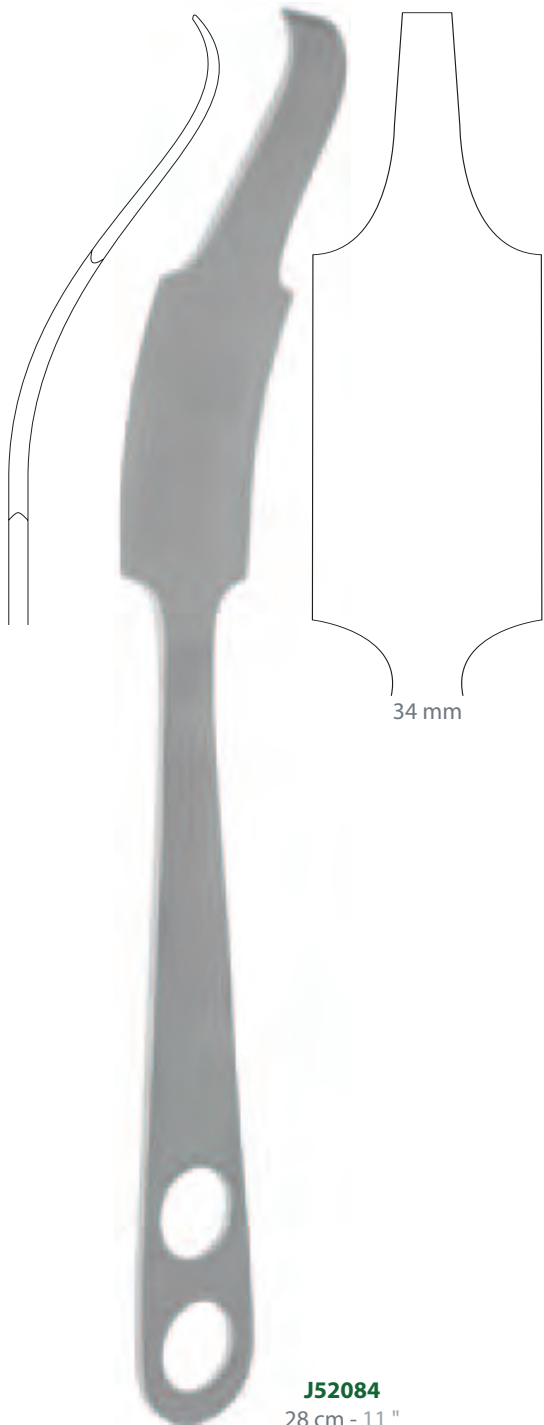

VII - Écarteurs  
VII - Retractors  
VII - Separadores

**VII - 102**

# LANDANGER

Instrumentation osseuse écarteurs - Osseous instrumentation retractors - Instrumentación osea separadores

## VERBRUGGE-MULLER

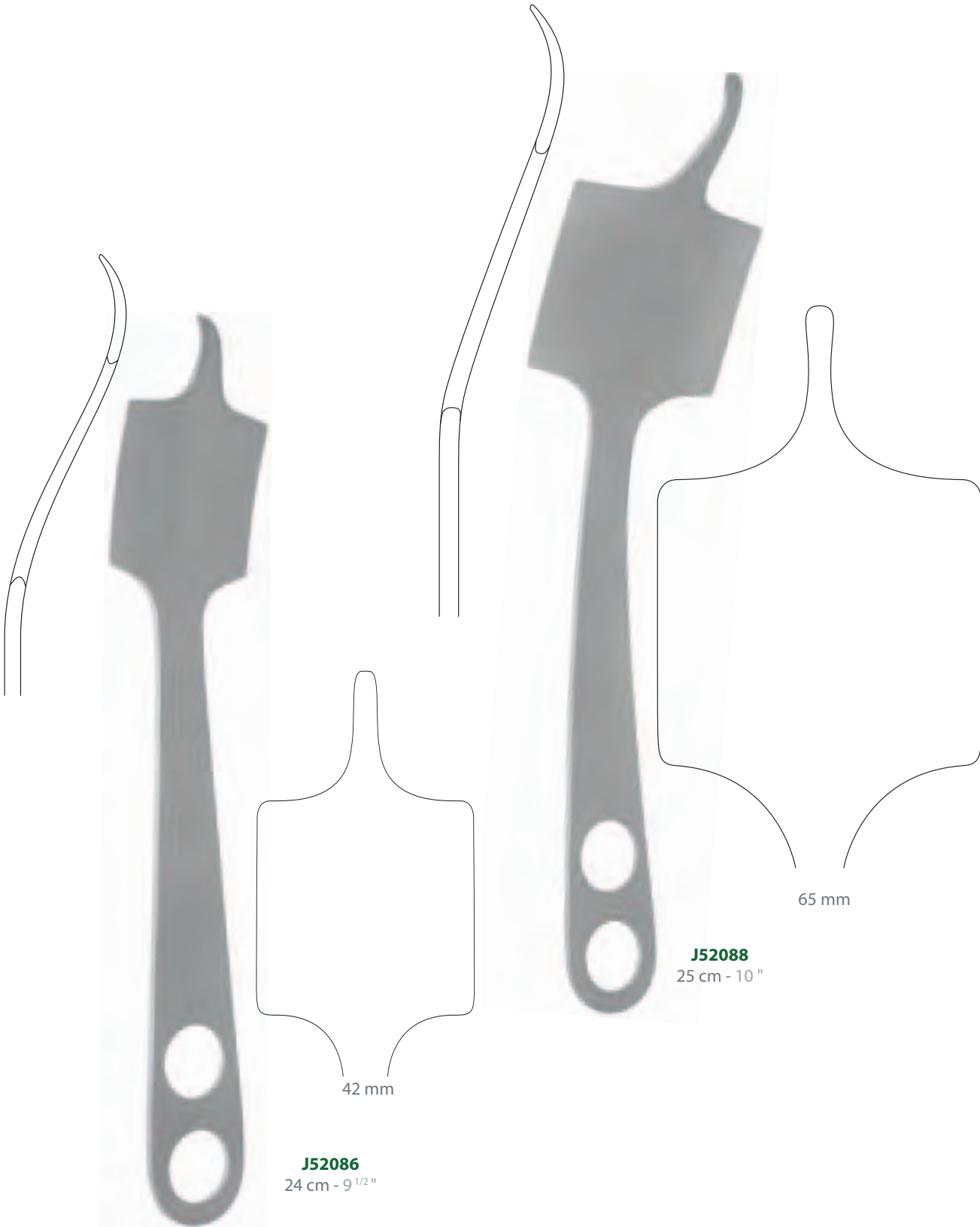

VII - Écarteurs  
VII - Retractors  
VII - Separadores

# LANDANGER

Instrumentation osseuse écarteurs - Osseous instrumentation retractors - Instrumentación osea separadores



## MERLE D'AUBIGNE



12 x 35 mm

**J52050**  
18 cm - 7 "



16 x 60 mm

**J52060**  
20 cm - 8 "



20 x 60 mm

**J52070**  
20 cm - 8 "

VII - Écarteurs  
VII - Retractors  
VII - Separadores

**VII - 104**

# LANDANGER

Instrumentation osseuse écarteurs - Osseous instrumentation retractors - Instrumentación osea separadores

## MERLE D'AUBIGNE



	P	L
J520230	40 mm	20 mm
J520231	40 mm	30 mm



**J520230**  
22 cm - 8 3/4 "

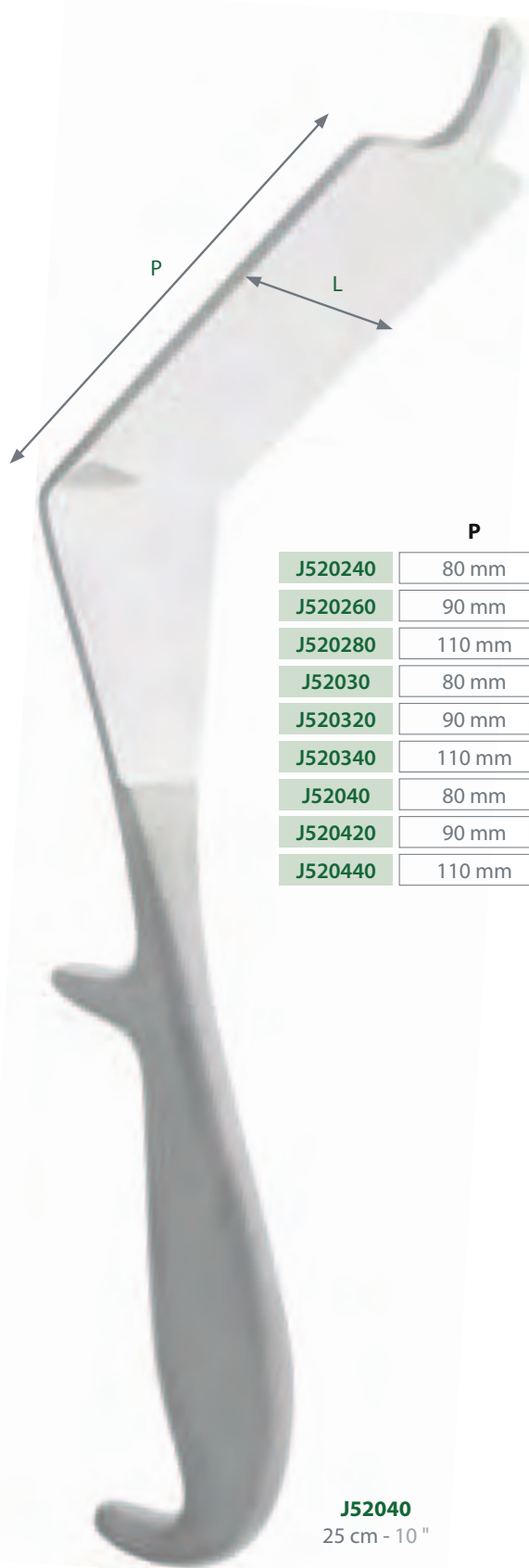

	P	L
J520240	80 mm	20 mm
J520260	90 mm	20 mm
J520280	110 mm	20 mm
J52030	80 mm	30 mm
J520320	90 mm	30 mm
J520340	110 mm	30 mm
J52040	80 mm	50 mm
J520420	90 mm	50 mm
J520440	110 mm	50 mm

**J52040**  
25 cm - 10 "

# LANDANGER

Instrumentation osseuse écarteurs - Osseous instrumentation retractors - Instrumentación osea separadores



**BENNET**

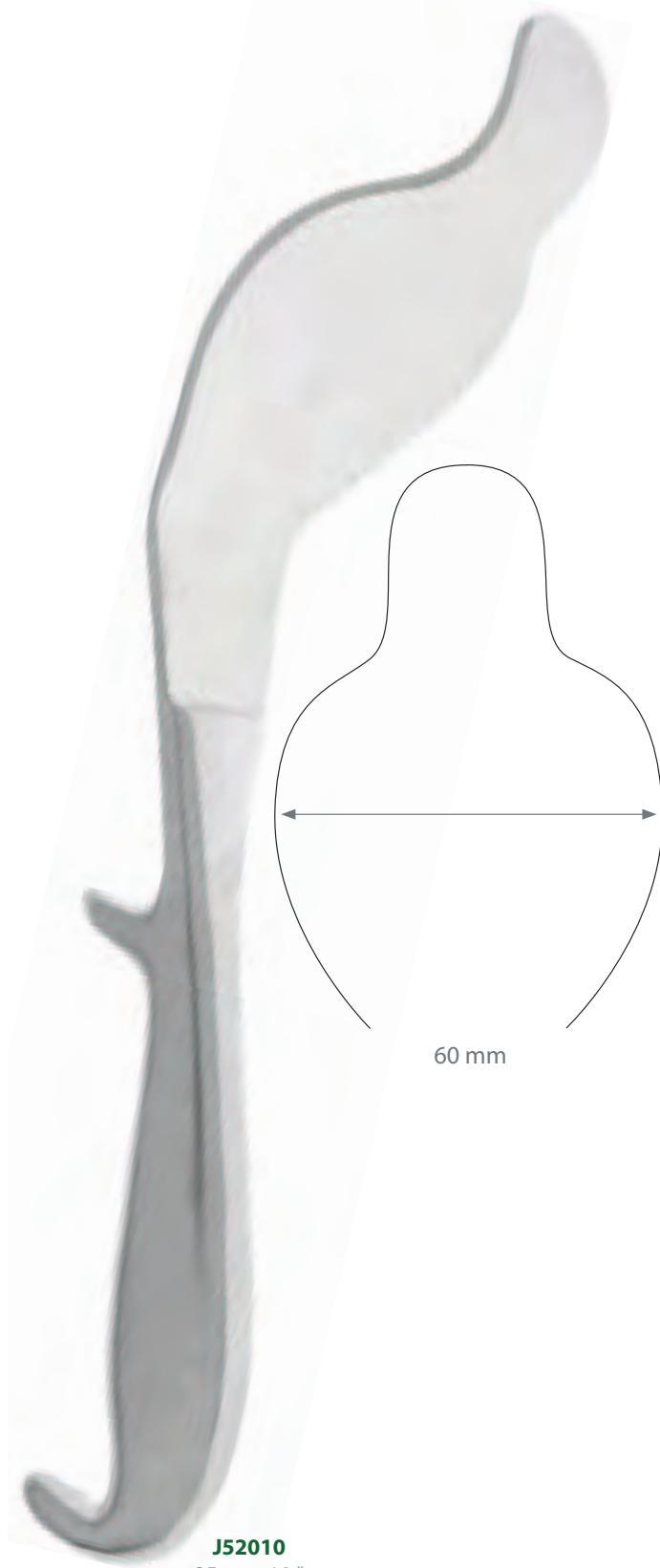

**J52010**  
25 cm - 10 "

**TRILLAT**

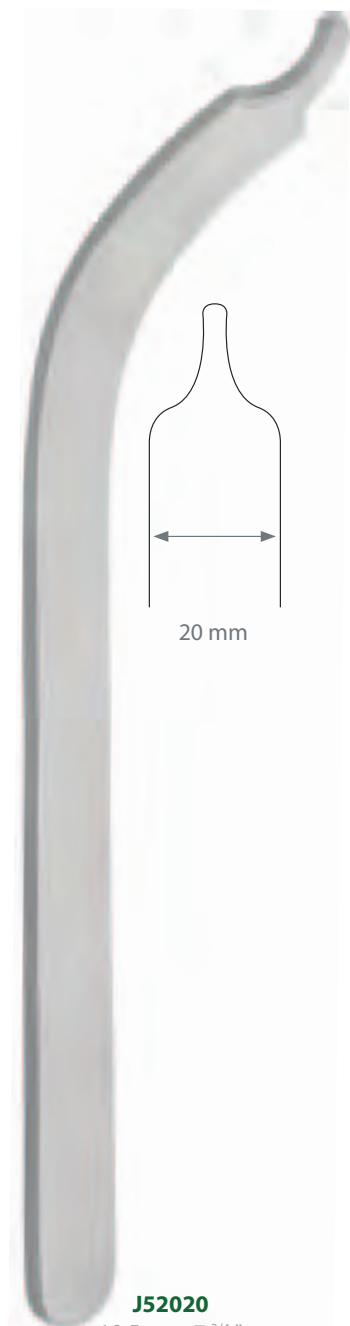

**J52020**  
19,5 cm - 7 3/4 "

Pour avant bras  
For forearm  
Para antebrazo

VII - Écarteurs  
VII - Retractors  
VII - Separadores

**VII - 106**

# LANDANGER

Instrumentation osseuse écarteurs - Osseous instrumentation retractors - Instrumentación osea separadores

## CAUCHOIX



	P	L
J52210	60 mm	35 mm
J52220	80 mm	35 mm
J52230	100 mm	40 mm
J522400	150 mm	40 mm



**J52220**  
23 cm - 9"

# LANDANGER

Instrumentation osseuse écarteurs - Osseous instrumentation retractors - Instrumentación osea separadores

3/4

LAMBOTTE

MOORE LAMBOTTE

POSTEL



33 mm

2/3

Double  
Double  
Doble

**J52150**

18 x 33 mm  
31 cm - 12 1/4 "

Simple  
Simple  
Simple

**J521505**

33 mm  
29 cm - 11 1/2 "

18 mm

**VII - 108**



**J521600**

ø 10 mm  
29 cm - 11 1/2 "



115 mm

50 mm

**J52170**

19,5 cm - 8 "



Pinces à pansements - Dressing forceps - Pinzas para vendajes

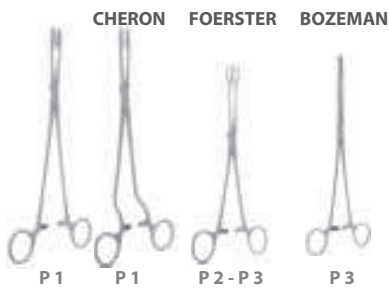

Pinces utérines - Uterines forceps - Pinzas uterinas

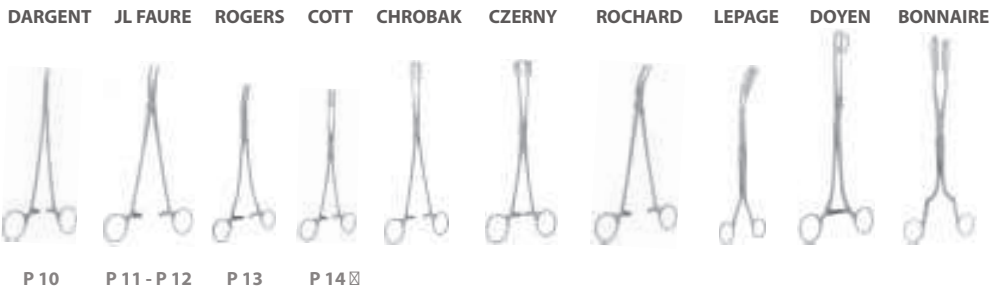
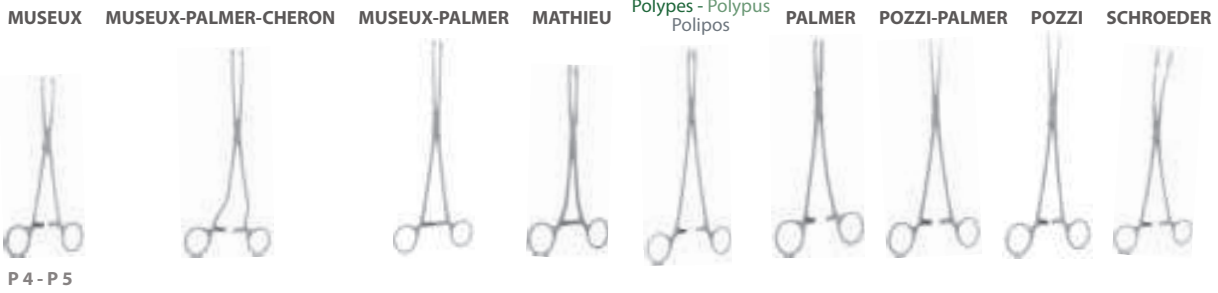

Pince hystérolable - Uterine elevating forceps - Pinzas para coger el utero

DARTIGUES



P 18

Forceps spatules - Obstetrical forceps - Forceps obstetricos



Anusscopes - Anusscopes - Anuscopios



Dilatateurs anals - Anal dilators - Dilatadores anal



P 25 P ☒

Ecarteurs anals - Rectal retractors - Separadores rectal



P 25

Amnioscopes - Amnioscopes - Amnioscopo



P 29 P 29

Speculums vaginaux - Vaginal speculas - Especulos vaginales



P 30

Pincès à biopsie - Biopsy forceps - Pinzas para biopsia



P 37 ☒

Endospeculums - Endospeculas - Endoespeculos



P 36

Valves vaginales - Vaginal blades - Valvulas vaginales



P 41 P 4☒

Divers - Miscellaneous - Diverso



P 49 P 49 P 50 P 51 P 51 ☒

Curettes utérines - Uterines curettes - Curetas uterinas

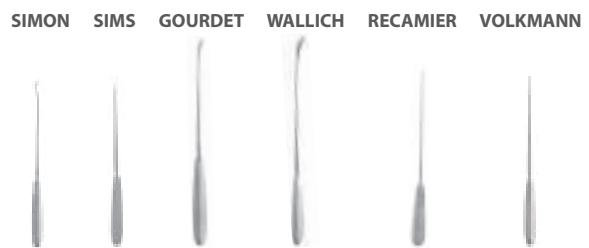

Hystérogaphie - Hysterography - Hysterografía

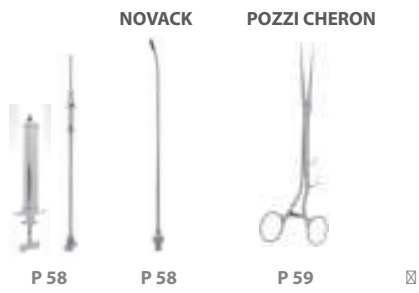

Dilatateurs utérins - Uterine dilators - Dilataadores uterinos



Hysteromètres - Uterine sounds - Hysterómetros



Ciseaux - Scissors - Tijeras



Ciseaux à épisiotomie - Episiotomy scissors - Tijeras episiotomía Ventouse obstétricale - Cupping glass obstetric - Ventosa obstetrica





# LANDANGER

Pince à pansements - Dressing forceps - Pinza para vendajes



Droite  
Straight  
Recta

Courbe  
Curved  
Curva

CHERON

24 cm - 9 1/2 "

**F10030**

**F10040**

30 cm - 11 3/4 "

**F10050**

**F10060**



Courbe  
Curved  
Curva

**F10030**  
24 cm - 9 1/2 "



**F10100**  
24 cm - 9 1/2 "

**VIII - 1**

# LANDANGER

Pince à pansements - Dressing forceps - Pinza para vendajes



## FOERSTER



Mors striés  
Serrated jaws  
Boca estriada

Droite Straight Recta	Courbe Curved Curva
-----------------------------	---------------------------

20 cm - 8 "

<b>F10210</b>	<b>F10220</b>
---------------	---------------

25 cm - 10 "

<b>F10230</b>	<b>F10240</b>
---------------	---------------

**F10210**

20 cm - 8 "

# LANDANGER

## Pince à pansements - Dressing forceps - Pinza para vendajes

### FOERSTER

Droite  
Straight  
Recta

Courbe  
Curved  
Curva

18 cm - 7 "

**F102000**

**F102001**

25 cm - 10 "

**F102010**

**F102011**

### BOZEMANN



Droite  
Straight  
Recta

Double courbure  
Double curved  
Doble curvatura

26 cm - 10 1/4 "

**F102050**

**F102051**



Mors lisses  
Smooth jaws  
Boca liso

**F102000**  
20 cm - 8 "



Mors striés  
Serrated jaws  
Boca estriado

**F102050**  
26 cm - 10 1/4 "



**F102051**  
26 cm - 10 1/4 "

**VIII - 3**

# LANDANGER

## Pinces utérines - Uterines forceps - Pinzas uterinas



### MUSEUX

Droite  
Straight  
Recta

14 cm - 5 1/2 "	<b>F10340</b>
16 cm - 6 1/4 "	<b>F10350</b>
18 cm - 7 "	<b>F10360</b>





# LANDANGER

Pinces utérines - Uterines forceps - Pinzas uterinas

## MUSEUX



**F10380**  
24 cm - 9 1/2 "

4 griffes  
4 teeth  
4 dientes



**F10380**  
7 mm



**F10390**  
9 mm



**F10400**  
11 mm

6 griffes  
6 teeth  
6 dientes



**F104100**  
11 mm

**VIII - 5**

# LANDANGER

Pinces utérines - Uterines forceps - Pinzas uterinas



MUSEUX PALMER-CHERON

MUSEUX PALMER



**F10420**  
23 cm - 9"



**F10450**  
24 cm - 9 1/2"

**VIII - 6**

MATHIEU



**VIII - 7**

# LANDANGER

Pinces utérines (polypes) - Uterines forceps (polypus) - Pinzas uterinas (polipos)



PALMER



**F10460**  
24 cm - 9 1/2 "

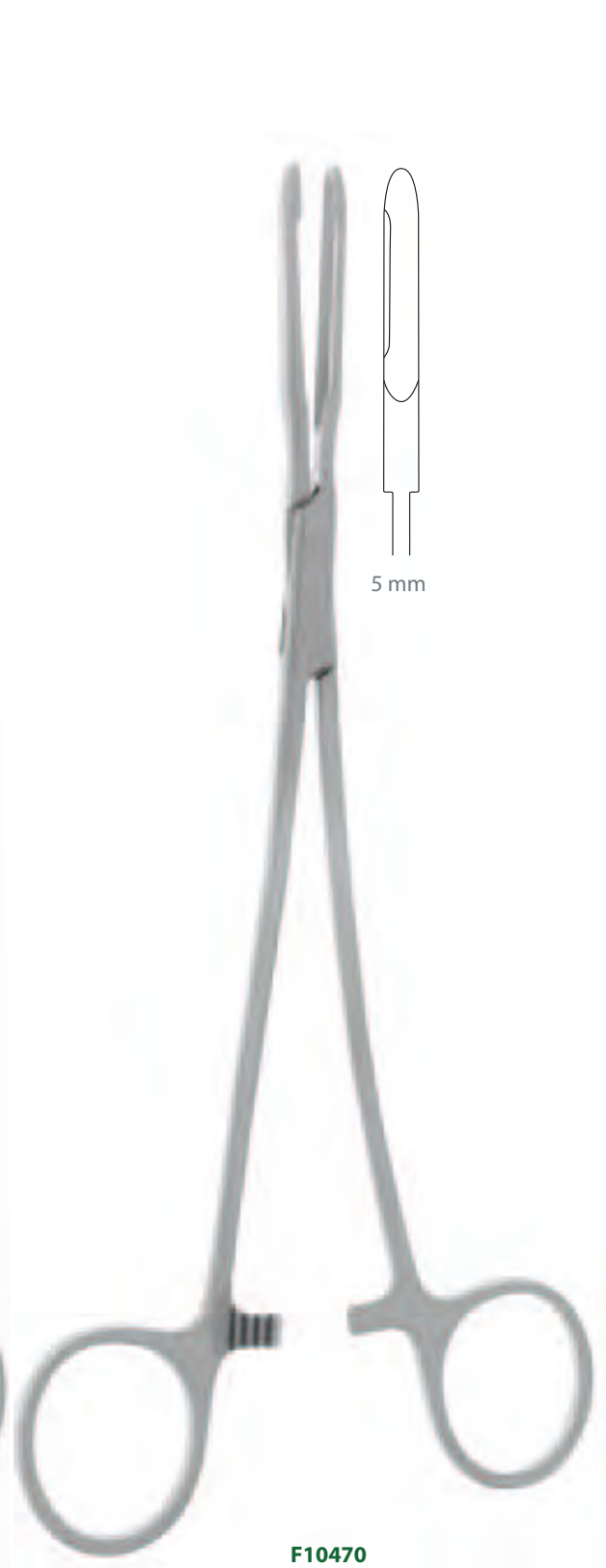

**F10470**  
22 cm - 8 3/4 "

**VIII - 8**

# LANDANGER

Pinces utérines - Uterines forceps - Pinzas uterinas

POZZI PALMER

POZZI



**F10480**  
23 cm - 9 "



**F10505**  
18 cm - 7 "



**F10515**  
24 cm - 9 1/2 "

**VIII - 9**

# LANDANGER

Pinces utérines - Uterines forceps - Pinzas uterinas



SCHROEDER



**F10516**  
24 cm - 9 1/2"

DARGENT

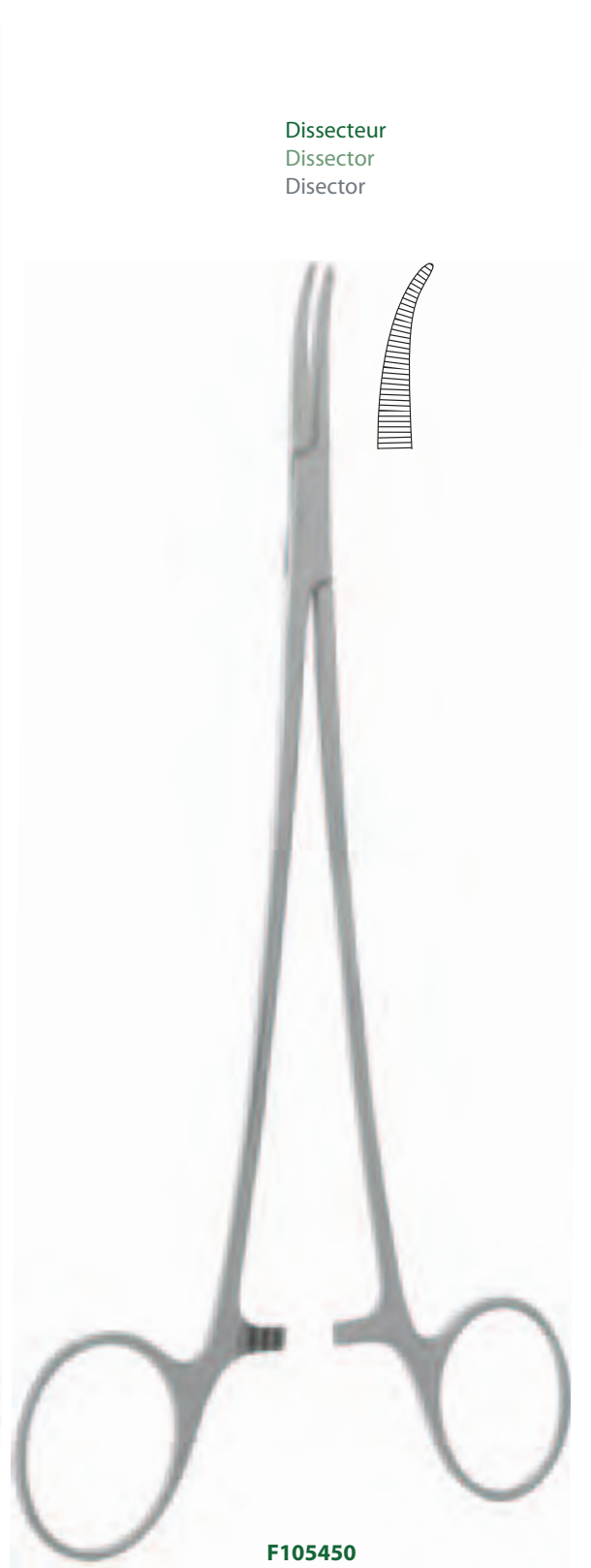

Dissecteur  
Dissector  
Disector

**F105450**  
20 cm - 8"

# LANDANGER

Pinces utérines - Uterines forceps - Pinzas uterinas

JL FAURE



Modèle léger  
Light model  
Modelo ligero

Modèle fort  
Strong model  
Modelo pesado



**F10550**  
21 cm - 8 1/4 "



**F10570**  
21 cm - 8 1/4 "

**F105760**  
25 cm - 10 "

**VIII - 11**

# LANDANGER

## Pinces utérines - Uterines forceps - Pinzas uterinas



### JL FAURE

A plateaux  
With plates  
Con platos



**F10580**  
22 cm - 8 3/4 "

A ligament large  
For wide ligament  
Para ligamento ancho



**F10590**  
25 cm - 10 "



# LANDANGER

## Pinces utérines - Uterines forceps - Pinzas uterinas

### ROGERS



	Droite Straight Recta	1/2 Courbe 1/2 Curved 1/2 Curva	Courbe Curved Curva	Très courbe Very curved Muy curva			
22,5 cm - 8 3/4 "	<b>F105910</b>	22 cm - 8 1/2 "	<b>F105911</b>	21,5 cm - 8 1/2 "	<b>F105912</b>	20,5 cm - 8 "	<b>F105913</b>
25 cm - 9 3/4 "	<b>F105920</b>	24,5 cm - 9 1/2 "	<b>F105921</b>	24 cm - 9 1/2 "	<b>F105922</b>	23 cm - 9 "	<b>F105923</b>

Mors atraumatique  
Atraumatic jaws  
Bocas atraumaticos



**F105921**  
24,5 cm - 9 3/4 "

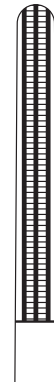

**F105920**  
25 cm - 10 "

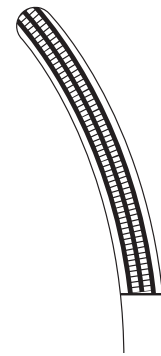

**F105921**  
24,5 cm - 9 3/4 "

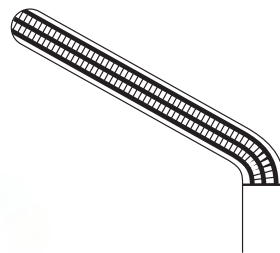

**F105923**  
23 cm - 9 "

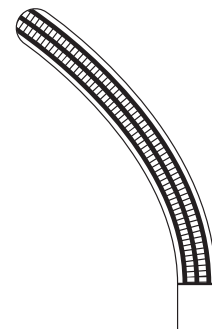

**F105922**  
24 cm - 9 1/2 "

# LANDANGER

Pinces utérines - Uterines forceps - Pinzas uterinas



## COTT (A LAMBEAUX)

## CHROBAK

Mors  
Jaws  
Bocas

22,5 cm - 8 <sup>3</sup>/<sub>4</sub> " **F106040** 4,5 mm

21 cm - 8 <sup>1</sup>/<sub>4</sub> " **F10605** 6,0 mm

4 x 4 griffes  
4 x 4 teeth  
4 x 4 dientes

10 mm



3 x 3 griffes  
3 x 3 teeth  
3 x 3 dientes

6 mm

**F10605**  
21 cm - 8 <sup>1</sup>/<sub>4</sub> "



**F106060**  
26 cm - 10 <sup>1</sup>/<sub>4</sub> "

# LANDANGER

Pinces utérines - Uterines forceps - Pinzas uterinas

CZERNY



**F108200**  
20,5 cm - 8 "



**F108205**  
26 cm - 10 1/4 "

**VIII - 15**

# LANDANGER

Pinces utérines - Uterines forceps - Pinzas uterinas



## ROCHARD

## LEPAGE

Pince à faux germes  
Ovum forceps  
Pinza para aborto



**F10610**

21 cm - 8 1/4 "



**F10630**

27 cm - 10 1/2 "

**VIII - 16**

# LANDANGER

Pinces utérines - Uterines forceps - Pinzas uterinas

## DOYEN

Pince à ovaire  
Ovarian forceps  
Pinza para ovarios



## BONNAIRE



VIII - 17

# LANDANGER

Pince hystérolable - Uterine elevating forceps - Pinzas para coger el utero

4/5

## DARTIGUES

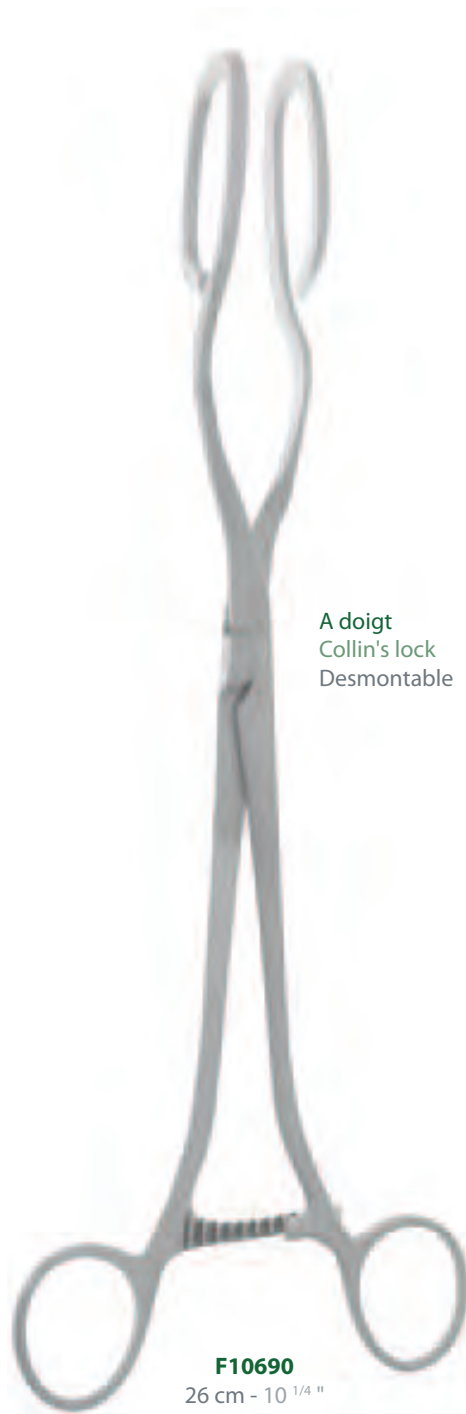

A doigt  
Collin's lock  
Desmontable

**F10690**  
26 cm - 10 1/4 "

# LANDANGER

Forceps spatules - Obstetrical forceps - Forceps obstetricos

2/3

## TARNIER

Complet  
Complete  
Completo

**F10710**  
40 cm - 15 <sup>3</sup>/<sub>4</sub> "

Tracteur seul  
Traction handle only  
Tractor sólo

**F107105**

**VIII - 19**

# LANDANGER

Forceps spatules - Obstetrical forceps - Forceps obstetricos



## DEMELIN-SUZOR

Système de serrage seul  
Screw system only  
Sistema de apreta solo



**F107210**

Barre de liaison seule  
Connecting plate only  
Barra de unión sólo

**F107205**

Complet  
Complete  
Completo

**F10720**  
32 cm - 12 1/2"



# LANDANGER

Forceps spatules - Obstetrical forceps - Forceps obstetricos



PAJOT



**F10730**  
33 cm - 13"

MC LEAN



**F107870**  
36 cm - 14 1/4"

KIELAND



**F10732**  
41 cm - 16 1/4"

**VIII - 21**

# LANDANGER

## Forceps spatules - Obstetrical forceps - Forceps obstetricos

1/2

**NAGELE**



**F107330**  
40 cm - 15 3/4"

Spatules obstétricales (paire)  
Obstetrical spatulas (pair)  
Espatulas obstetricas (par)



**F10735**  
39 cm - 15 1/4"

**F10736**  
36 cm - 14 1/4"



## TEISSIER

Les 2 spatules sans tracteur  
The 2 spatulas without traction handle  
Las 2 espátulas sin tractor



**F10737**  
31 cm - 12 1/4 "

Tracteur seul  
Traction handle only  
Tractor sólo



**F10738**

**VIII - 23**

# LANDANGER

Anusopes - Anusopes - Anuscopios



## BENSAUDE



# LANDANGER

Dilatateurs anals - Anal dilators - Dilatadores anal



## TRELAT



Avec crémaillère  
With rack  
Con cremallera

**F15340**  
20 cm - 8 "



Sans crémaillère  
Without rack  
Sin cremallera

**F15350**  
20 cm - 8 "

**VIII - 25**

# LANDANGER

Dilatateurs anals - Anal dilators - Dilatadores anal

3/4

SIMS



**F153610**  
15 cm - 6 "



**F153620**  
15 cm - 6 "

# LANDANGER

Ecarteurs anals - Rectal retractors - Separadores rectal



## BAR

	O	P	L
<b>B80885</b>	75 mm	70 mm	22 mm

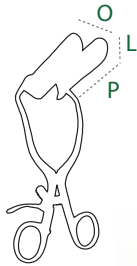

**B80885**

17 cm - 6 <sup>3</sup>/<sub>4</sub> "

O : Ouverture - Blade opening - Apertura de las hojas  
P : Profondeur - Depth - Profundidad  
L : Largeur - Width - Anchura

**VIII - 27**

# LANDANGER

## Ecarteurs anals - Rectal retractors - Separadores rectal



### ALAN PARKS

Valve médiane seule  
Central blade only  
Valvulas mediana solas

95 x 24 mm

**B808852**

Avec 2 paires de valves latérales et 1 valve médiane  
With 2 pairs of lateral blades and 1 center blade  
Con 2 pares de valvulas laterales y 1 valvula mediana

**B80880**



Valves latérales (paire)  
Lateral blades (pair)  
Valvulas laterales (par)

95 x 24 mm

**B808850**



75 x 24 mm

**B808851**



O : 0 - 13,5 cm - 5 1/4 "



# LANDANGER

Amnioscopes - Amnioscopes - Amnioscopo

## AMNIOSCOPE



Complet avec mandrin  
Complete with mandril  
Completo con mandrino

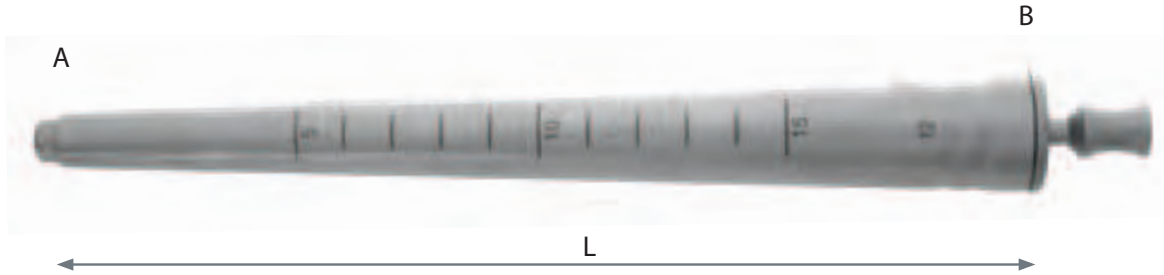

	Ø A	Ø B	L
F15370	12 mm	24 mm	200 mm
F15380	16 mm	24 mm	200 mm
F15390	20 mm	24 mm	200 mm

## AMNIOSCOPE PLEXIGLAS

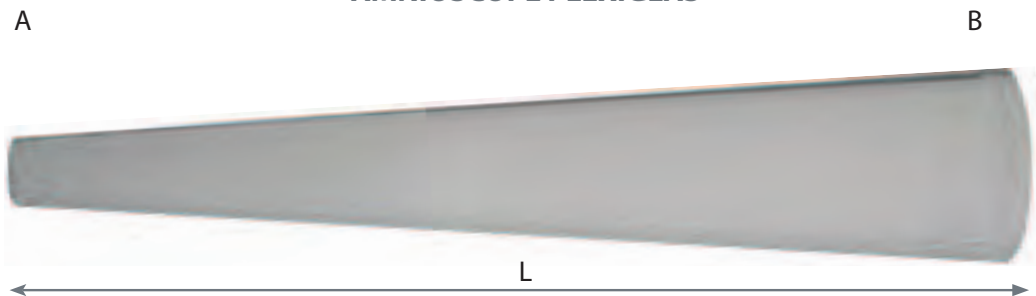

	Ø A	Ø B	L
F15410	10 mm	30 mm	205 mm
F15414	14 mm	40 mm	205 mm
F15420	20 mm	47 mm	205 mm

# LANDANGER

## Spéculum vaginaux - Vaginal speculas - Especulos vaginales



### COLLIN



90 x 14 mm	<b>F16000</b>
90 x 16 mm	<b>F16010</b>
90 x 25 mm	<b>F16020</b>
90 x 30 mm	<b>F16030</b>
95 x 35 mm	<b>F16034</b>
105 x 30 mm	<b>F16038</b>
105 x 35 mm	<b>F16040</b>
105 x 38 mm	<b>F16050</b>
110 x 42 mm	<b>F16060</b>

100 x 25 mm	<b>F17025</b>
100 x 30 mm	<b>F17030</b>
100 x 35 mm	<b>F17035</b>
100 x 40 mm	<b>F17040</b>

### **F178000**

Adaptation d'un tube d'aspiration sur un spéculum vaginal  
Adaptation of one aspiration tube on a vaginal speculum  
Adaptación de un tubo de aspiración sobre un espéculo vaginal

### COLLIN

Modèle avec tube d'aspiration  
Model with aspiration tube  
Modelo con tubo de aspiración

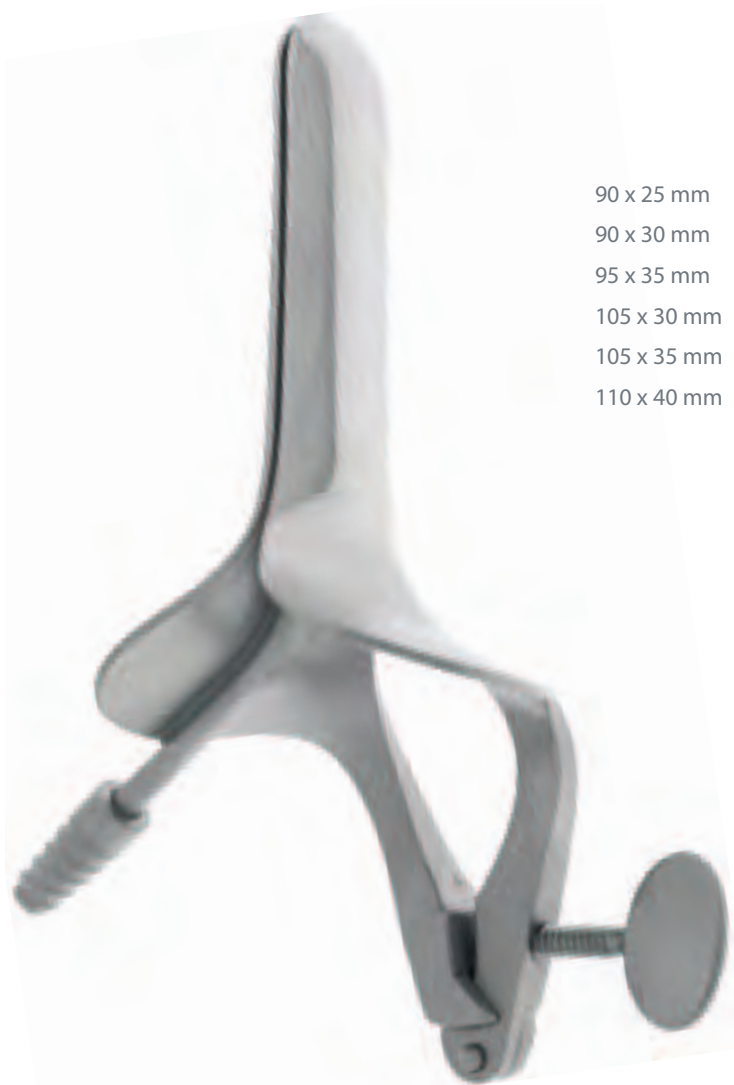

90 x 25 mm	<b>F18125</b>
90 x 30 mm	<b>F18130</b>
95 x 35 mm	<b>F18135</b>
105 x 30 mm	<b>F18230</b>
105 x 35 mm	<b>F18235</b>
110 x 40 mm	<b>F18240</b>

# LANDANGER

## Spéculum vaginaux - Vaginal speculas - Especulos vaginales



### COLLIN

Longues valves  
Long blades  
Valvulas largas



150 x 30 mm **F17130**

150 x 35 mm **F17135**

150 x 40 mm **F17140**

**F178000**

Adaptation d'un tube d'aspiration sur un spéculum vaginal  
Adaptation of one aspiration tube on a vaginal speculum  
Adaptación de un tubo de aspiración sobre un espéculo vaginal

# LANDANGER

## Spéculum vaginaux - Vaginal speculas - Especulos vaginales



### CUSCO

Pliant  
Pliable  
Plegable

100 x 16 mm	<b>F16070</b>
100 x 25 mm	<b>F16080</b>
100 x 28 mm	<b>F16090</b>
100 x 30 mm	<b>F16100</b>
100 x 35 mm	<b>F16110</b>
100 x 37 mm	<b>F16120</b>
100 x 40 mm	<b>F16130</b>

Fixe  
Fixed  
Fijo

100 x 16 mm	<b>F16140</b>
100 x 25 mm	<b>F16150</b>
100 x 28 mm	<b>F16160</b>
100 x 30 mm	<b>F16170</b>
100 x 35 mm	<b>F16180</b>
100 x 37 mm	<b>F16190</b>
100 x 40 mm	<b>F16200</b>



**VIII - 33**

# LANDANGER

## Spéculum vaginaux - Vaginal speculas - Especulos vaginales



### SPÉCULUM POUR VIERGE VIRGIN SPECULA ESPECÚLO PARA VIRGEN

### PALMER

90 x 12 mm	F16210
90 x 12 mm	F16220
90 x 12 mm	F16230
90 x 12 mm	F16240
90 x 12 mm	F16250

65 x 35 mm	F17165
------------	--------



## JAYLE



100 x 30 mm **F17630**

100 x 34 mm **F17634**

100 x 38 mm **F17638**

Longues valves

Long blades

Valvulas largas

150 x 34 mm **F17734**

150 x 38 mm **F17738**

### F178000

Adaptation d'un tube d'aspiration sur un spéculum vaginal

Adaptation of one aspiration tube on a vaginal speculum

Adaptación de un tubo de aspiración sobre un espéculo vaginal

# LANDANGER

Endospéculums - Endospeculas - Endoespeculos



KOGAN



**F190010**  
24 cm - 9 1/2 "



# LANDANGER

Pinces à biopsie - Biopsy forceps - Pinzas para biopsia

## TISCHLER-MORGAN

1/2



## MINI-TOWSEND

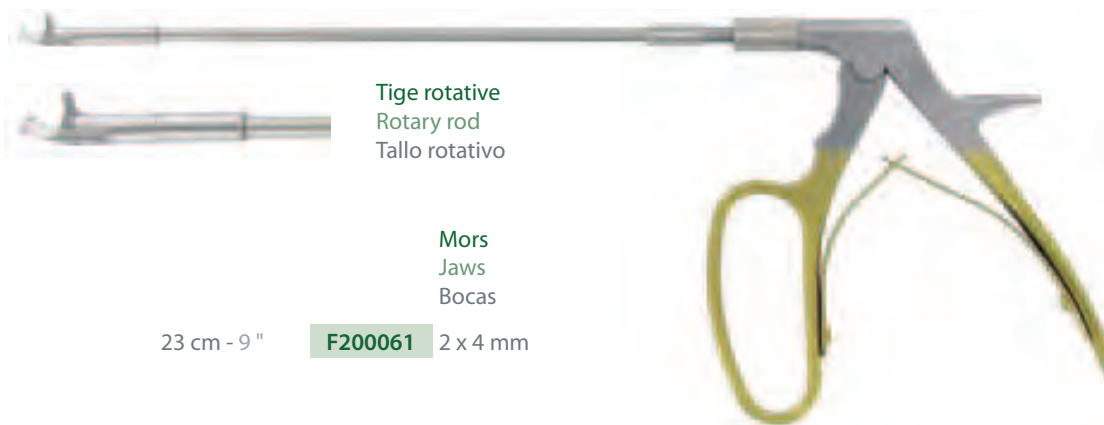

VIII - 37

# LANDANGER

## Pinces à biopsie - Biopsy forceps - Pinzas para biopsia



### DOUAY



Mors  
Jaws  
Bocas

20 cm - 8 "	<b>F20010</b>	4 x 10 mm
25 cm - 10 "	<b>F20020</b>	4 x 10 mm
30 cm - 11 <sup>3</sup> / <sub>4</sub> "	<b>F20030</b>	4 x 10 mm

### BERGER

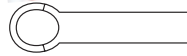

Coupe ronde  
Round cut  
Corte redonda

20 cm - 8 "	<b>F20070</b>	Ø 5 mm
-------------	---------------	--------

# LANDANGER

Pinces à biopsie - Biopsy forceps - Pinzas para biopsia

3/5

## SCHUMAKER

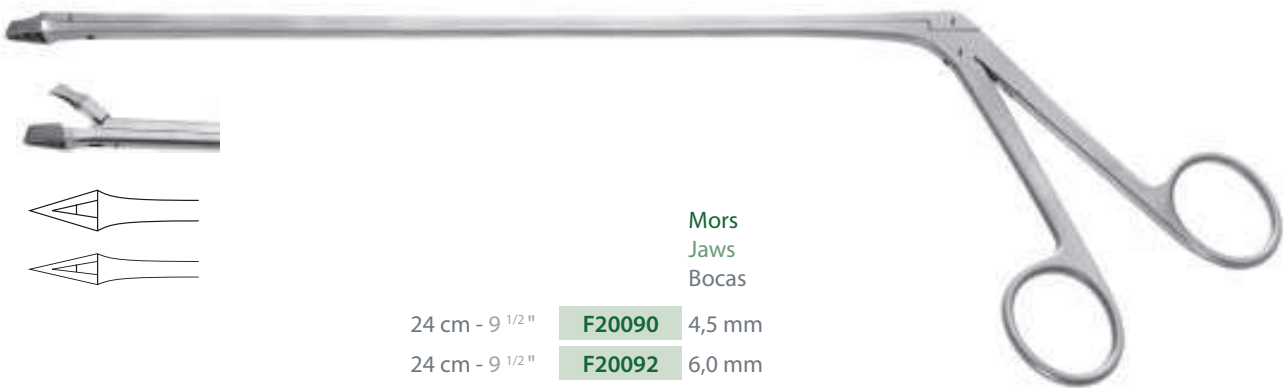

## LANDANGER

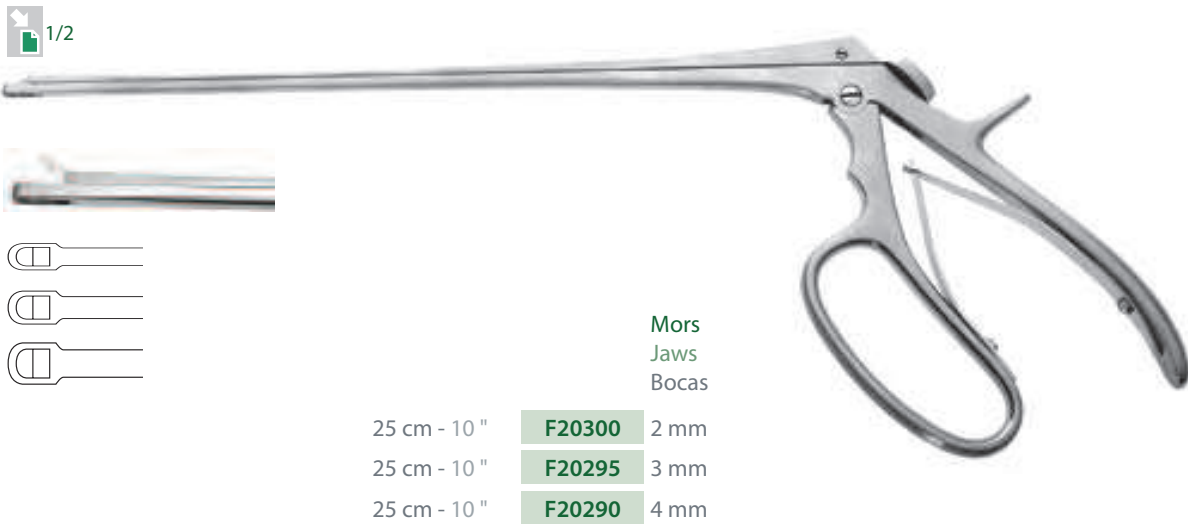

# LANDANGER

Pinces à biopsie - Biopsy forceps - Pinzas para biopsia



J. L. FAURE

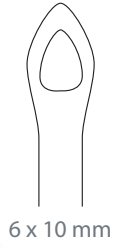

6 x 10 mm

**F20160**  
25 cm - 10 "

**VIII - 40**

SHUBERT



4,5 x 8 mm

**F20165**  
26 cm - 10 1/4 "

# LANDANGER

## Valves vaginales - Vaginal blades - Valvulas vaginales



### JAYLE

Valve + Poids  
Blade + Weight  
Valvula + Peso

#### F25010

6 cm - 2 3/8 "

#### F25020

9 cm - 3 1/2 "

Valve seule  
Blade only  
Valvula sóla

#### F250110

6 cm - 2 3/8 "

#### F250210

9 cm - 3 1/2 "



Poids seul (1000g)  
Weight only (2,2 pounds)  
Peso sólo (1000g)

#### F25025



**VIII - 41**

# LANDANGER

Valves vaginales - Vaginal blades - Valvulas vaginales



## DOYEN

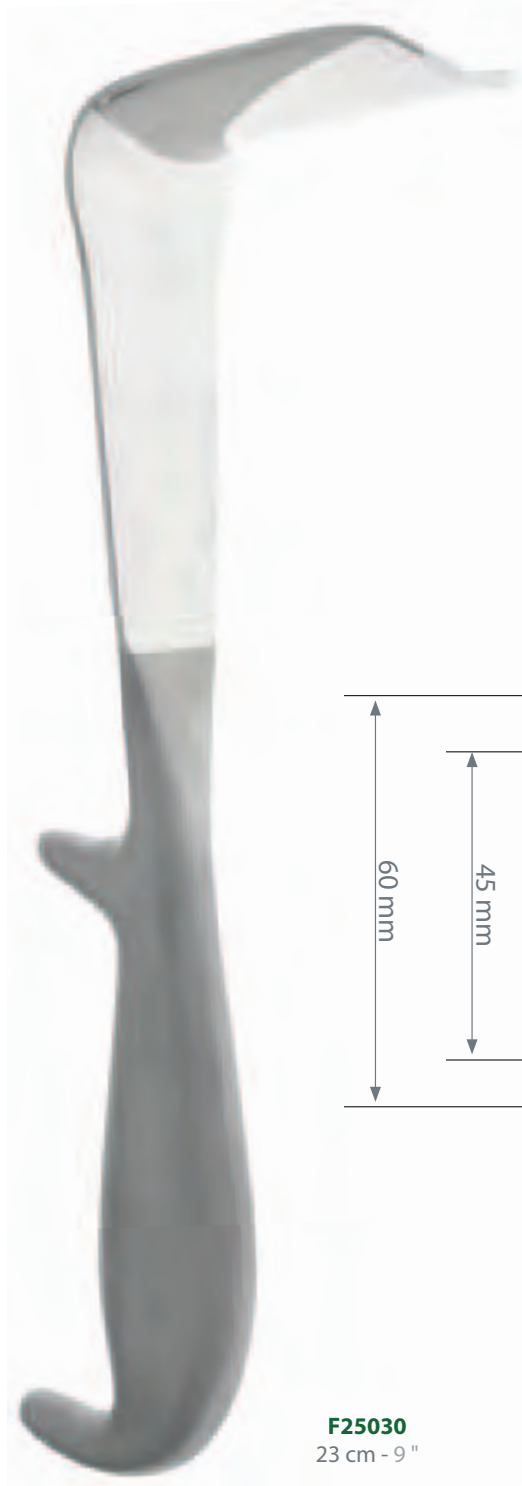

**F25030**  
23 cm - 9 "

	Profondeur Depth Profundidad	Largeur Width Anchura
--	------------------------------------	-----------------------------

<b>F250280</b>	60 mm	35 mm
<b>F25030</b>	60 mm	45 mm
<b>F25060</b>	60 mm	60 mm
<b>F25035</b>	90 mm	35 mm
<b>F25040</b>	90 mm	45 mm
<b>F25070</b>	90 mm	60 mm
<b>F250450</b>	120 mm	35 mm
<b>F25050</b>	120 mm	45 mm
<b>F25080</b>	120 mm	60 mm

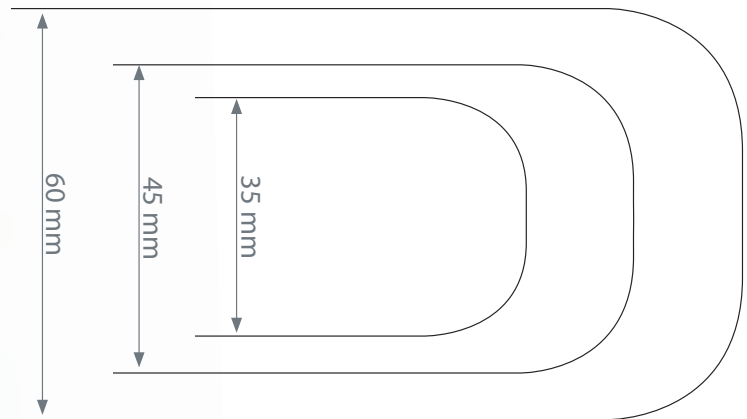

# LANDANGER

## Valves vaginales - Vaginal blades - Valvulas vaginales

Pour intervention par voie vaginale  
For operation through vaginal tract  
Para intervención por vía vaginal



N° 1  
44 x 70 mm

**F25100**  
23 cm - 9 "



N° 2  
29 x 80 mm

**F25105**  
25 cm - 10 "

**VIII - 43**

# LANDANGER

## Valves vaginales - Vaginal blades - Valvulas vaginales



N° 4  
43 x 70 mm



N° 5  
44 x 60 mm

**F25110**  
29 cm - 11 1/2 "

**F25115**  
23 cm - 9 "

**VIII - 44**



# LANDANGER

## Valves vaginales - Vaginal blades - Valvulas vaginales



Pour intervention par voie vaginale  
For operation through vaginal tract  
Para intervención por vía vaginal



N° 6

28 x 131 mm

N° 7

40 x 128 mm

Convexe  
Convex  
Convexo

**F25125**

23 cm - 9 "

**F25120**

24 cm - 9 1/2 "

**VIII - 45**

# LANDANGER

Valves vaginales - Vaginal blades - Valvulas vaginales

3/4

MANGIAGALLI

DOUGLAS



# LANDANGER

## Valves vaginales - Vaginal blades - Valvulas vaginales

### KRISTELLER

### BRIESKY

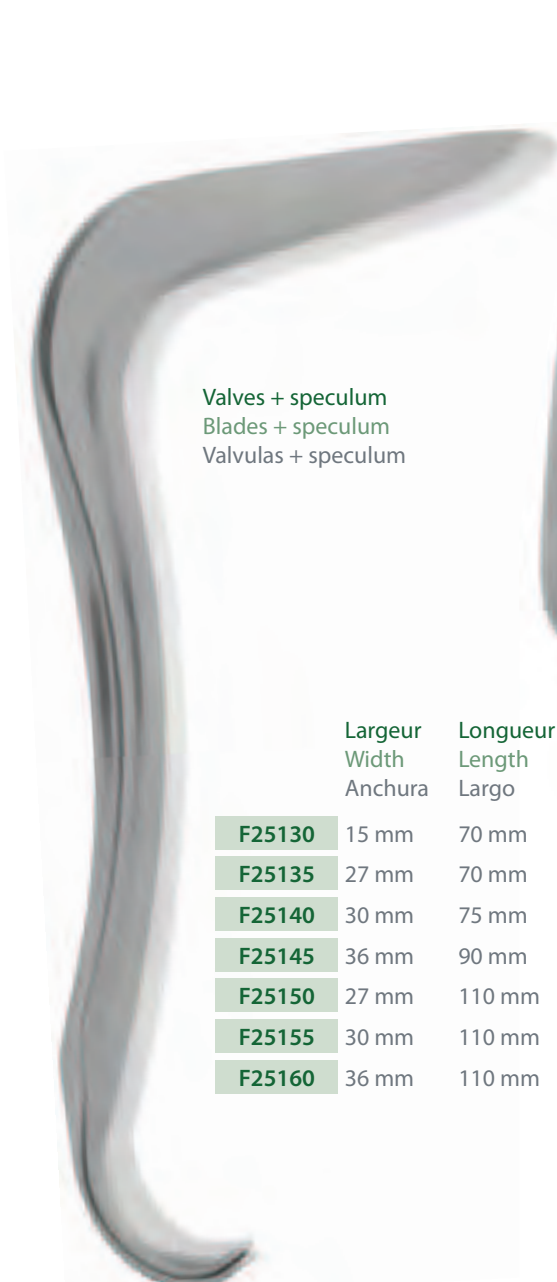

Valves + speculum  
Blades + speculum  
Valvulas + speculum

	Largeur Width Anchura	Longueur Length Largo
<b>F25130</b>	15 mm	70 mm
<b>F25135</b>	27 mm	70 mm
<b>F25140</b>	30 mm	75 mm
<b>F25145</b>	36 mm	90 mm
<b>F25150</b>	27 mm	110 mm
<b>F25155</b>	30 mm	110 mm
<b>F25160</b>	36 mm	110 mm

**F25135**  
21 cm - 8 1/4"

		Largeur Width Anchura	Longueur Length Largo
32 cm - 12 1/2"	<b>F25165</b>	20 mm	130 mm
32 cm - 12 1/2"	<b>F25170</b>	25 mm	130 mm
32 cm - 12 1/2"	<b>F25175</b>	30 mm	130 mm
32 cm - 12 1/2"	<b>F25180</b>	35 mm	130 mm
32 cm - 12 1/2"	<b>F25185</b>	40 mm	130 mm

Pour voies basses  
For low tracts  
Para vias bajas

27 cm - 10 3/4"	<b>F251640</b>	15 mm	70 mm
27,5 cm - 10 4/5"	<b>F251720</b>	28 mm	80 mm
28 cm - 11"	<b>F251770</b>	32 mm	90 mm
34 cm - 13 1/2"	<b>F251900</b>	40 mm	150 mm



**F25165**  
32 cm - 12 1/2"

**VIII - 47**

# LANDANGER

Valves vaginales - Vaginal blades - Valvulas vaginales

3/5

## DARGENT



Largeur  
Width  
Anchura

Longueur  
Length  
Largo

<b>N° 1</b>	38 cm - 15 "	<b>F260010</b>	40 mm	150 mm
<b>N° 2</b>	37 cm - 14 1/2 "	<b>F260020</b>	48 mm	135 mm
<b>N° 3</b>	35 cm - 13 3/4 "	<b>F260030</b>	50 mm	115 mm
<b>N° 4</b>	34 cm - 13 1/2 "	<b>F260040</b>	40 mm	115 mm
<b>N° 5</b>	33 cm - 13 "	<b>F260050</b>	38 mm	95 mm
<b>N° 6</b>	29 cm - 11 1/2 "	<b>F260060</b>	32 mm	90 mm
<b>N° 7</b>	28 cm - 11 "	<b>F260070</b>	28 mm	80 mm
<b>N° 8</b>	30 cm - 11 3/4 "	<b>F260080</b>	32 mm	90 mm
<b>N° 9</b>	30 cm - 11 3/4 "	<b>F260090</b>	30 mm	80 mm
<b>N° 10</b>	31cm - 12 1/4 "	<b>F260100</b>	30 mm	85 mm
<b>N° 11</b>	31 cm - 12 1/4 "	<b>F260110</b>	22 mm	77 mm
<b>N° 12</b>	26 cm - 10 1/4 "	<b>F260120</b>	15 mm	70 mm

F260010

# LANDANGER

Divers - Miscellaneous - Diverso



## DOYEN

Tracteur pour fibromes  
Mioma screw  
Tirabuzone para fibroma



**F10780**  
22 cm - 8 3/4"

## NOTTER

Perce membrane (amniotome)  
Membrane punch  
Perforador para la membrana



**F107900**  
22 cm - 8 3/4"

**F10800**  
22 cm - 8 3/4"

**VIII - 49**

# LANDANGER

Divers - Miscellaneous - Diverso



## BAR

Pince à couper les clamps  
Forceps to cut the clamps  
Pinzas para cortar los clamps



**F10755**  
15 cm - 6 "



**F10740**  
8,5 cm - 3 1/3 "

# LANDANGER

Divers - Miscellaneous - Diverso

**THERUM**  3/4

Pince pour retirer les fils de stérilets  
Forceps to take out the wire of coil  
Pinza para sacar los hilos de espiral

Manche à raccord tournant pour canule IVG sortie 10 à 15 mm  
Handle for cannula IVG output 10 to 15 mm  
Mango a racor rotativo para canula IVG 10 a 15 mm



**F305000**  
13,5 cm - 5 1/4 "



**F107050**  
27 cm - 10 3/4 "

**VIII - 51**

# LANDANGER

Curettes utérines - Uterines curettes - Curetas uterinas

3/4

## SIMON



F30010

4 mm



F30015

6 mm



F30020

8 mm

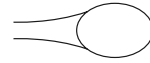

F30030

10 mm

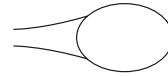

F30040

12 mm

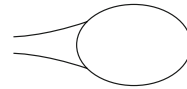

F30050

14 mm

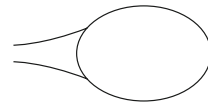

F30060

16 mm

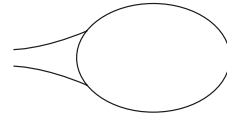

F30070

18 mm

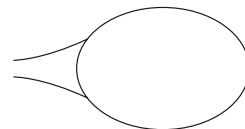

F30010

27 cm - 10<sup>3/4</sup>"

VIII - 52



# LANDANGER

Curettes utérines - Uterines curettes - Curetas uterinas

SIMS

3/4



**F30130**  
28 cm - 11"

<b>F30080</b>	3 mm	
<b>F30090</b>	4 mm	
<b>F30100</b>	5 mm	
<b>F30110</b>	6 mm	
<b>F30120</b>	8 mm	
<b>F30130</b>	10 mm	
<b>F30140</b>	12 mm	
<b>F30150</b>	14 mm	
<b>F30160</b>	16 mm	

**VIII - 53**

# LANDANGER

Curettes utérines - Uterines curettes - Curetas uterinas

1/1

## GOURDET



F30170

4 mm

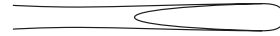

F30180

6 mm



F30190

8 mm



F30200

10 mm



F30210

12 mm

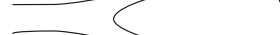

F30220

14 mm



F30230

16 mm



F30180

26 cm - 10 1/4"

# LANDANGER

Curettes utérines - Uterines curettes - Curetas uterinas

2/3

## WALLICH



**F30245**  
35 cm - 13 3/4"

**F30245**  
35 cm - 13 3/4"

12 mm

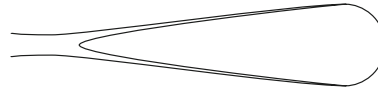

**F30280**

40 cm - 15 3/4"

**F30250**

35 cm - 13 3/4"

14 mm

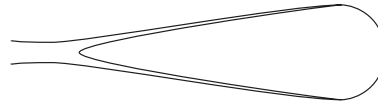

**F30290**

40 cm - 15 3/4"

**F30260**

35 cm - 13 3/4"

17 mm

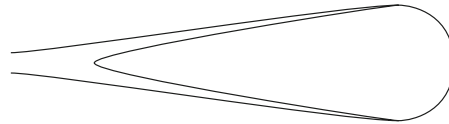

**F30300**

40 cm - 15 3/4"

**F30270**

35 cm - 13 3/4"

20 mm

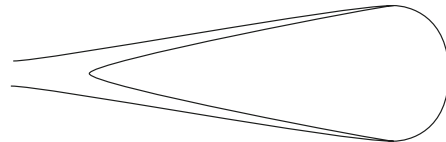

# LANDANGER

## Curettes utérines - Uterines curettes - Curetas uterinas

2/3

Tranchante  
Sharp  
Cortante

Mousse  
Blunt  
Roma

### RECAMIER



	Tranchante Sharp Cortante	Mousse Blunt Roma		
n° 00	F30311	F30332	5 mm	
n° 1	F30312	F30333	7 mm	
n° 3	F30313	F30334	9 mm	
n° 5	F30314	F30335	12 mm	
n° 6	F30316	F30336	14 mm	
n° 8	F30317	F30337	16 mm	
n° 9	F30319	F30338	19 mm	

**F30311**

31 cm - 12 1/4"

**F30332**

31 cm - 12 1/4"

**VIII - 56**

# LANDANGER

Curettes utérines - Uterines curettes - Curetas uterinas

VOLKMANN



F30340

3 mm



F30350

6 mm

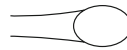

F30360

8 mm

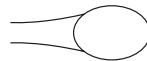

F30370

10 mm

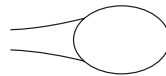

F30380

12 mm

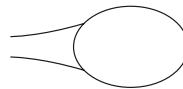

F30390

14 mm

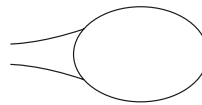

**F30340**  
28 cm - 11 "

**VIII - 57**

# LANDANGER

## Hystérographie - Hysterography - Hysterografia



### NOVACK

Joint du piston  
Piston seal  
Junta de piston



**F304321**

Joint en fibre pour l'embout  
Fibre seal for nozzle  
Junta fibra para contera



**F304322**

Seringue  
Syringe  
Jeringa



**F30432**

16 cm - 6 1/4"  
Ø 20 mm



Chromé  
Chrome  
Cromado

Canule  
Cannula  
Canula



**F30435**

22 cm - 8 3/4"  
Ø 5 mm



Chromé  
Chrome  
Cromado

Canule  
Cannula  
Canula



**F30420**

24 cm - 9 1/2"  
Ø 4 mm



POZZI CHERON



A crochets  
With hooks  
Con ganchos

**F30455**  
24 cm - 9 1/2 "

**VIII - 59**

# LANDANGER

## Ventouse obstétricale - Cupping glass obstetric - Ventosa obstetric

Ventouse  
Suction cup  
Ventosa

Diaphragme  
Diaphragm  
Diafragma

Poignée de traction  
Traction handle  
Puñado de tracción

	∅		∅	
F315005	30 mm	↔	F315015	40 mm
F315006	40 mm	↔	F315016	48 mm
F315007	50 mm	↔	F315017	58 mm



F315005



F315015



F315020  
∅ 20 mm  
10 cm - 4 "

Lac de traction (nylon)  
Vessel of traction (nylon)  
Bramante de tracción (nylon)

F315021

6 brins de 1 m  
6 wires of 39 1/4 "  
6 hilos de 1 m

3 tubes silicone  
3 silicon tubs  
3 tubos de silicona

F315022

2 m - ∅ 2 x 7 mm  
2 m - ∅ 2 x 7 mm  
2 m - ∅ 2 x 7 mm

Rouleau tube silicone  
Roll tub silicon  
Rollo tubo silicona

F315122

25 m - ∅ 2 x 7 mm  
25 m - ∅ 2 x 7 mm  
25 m - ∅ 2 x 7 mm





## HEGAR

Modèle simple  
Simple model  
Modelo simple



**F36160**  
18 cm - 7 "

	∅		∅
<b>F36010</b>	1 mm	<b>F36015</b>	1,5 mm
<b>F36020</b>	2 mm	<b>F36025</b>	2,5 mm
<b>F36030</b>	3 mm	<b>F36035</b>	3,5 mm
<b>F36040</b>	4 mm	<b>F36045</b>	4,5 mm
<b>F36050</b>	5 mm	<b>F36055</b>	5,5 mm
<b>F36060</b>	6 mm	<b>F36065</b>	6,5 mm
<b>F36070</b>	7 mm	<b>F36075</b>	7,5 mm
<b>F36080</b>	8 mm	<b>F36085</b>	8,5 mm
<b>F36090</b>	9 mm	<b>F36095</b>	9,5 mm
<b>F36100</b>	10 mm	<b>F36105</b>	10,5 mm
<b>F36110</b>	11 mm	<b>F36115</b>	11,5 mm
<b>F36120</b>	12 mm	<b>F36125</b>	12,5 mm
<b>F36130</b>	13 mm	<b>F36135</b>	13,5 mm
<b>F36140</b>	14 mm	<b>F36145</b>	14,5 mm
<b>F36150</b>	15 mm	<b>F36155</b>	15,5 mm
<b>F36160</b>	16 mm	<b>F36165</b>	16,5 mm
<b>F36170</b>	17 mm	<b>F36175</b>	17,5 mm
<b>F36180</b>	18 mm	<b>F36185</b>	18,5 mm
<b>F36190</b>	19 mm	<b>F36195</b>	19,5 mm
<b>F36200</b>	20 mm		
<b>F36210</b>	21 mm		
<b>F36220</b>	22 mm		
<b>F36230</b>	23 mm		
<b>F36240</b>	24 mm		
<b>F36250</b>	25 mm		
<b>F36260</b>	26 mm		
<b>F362610</b>	27 mm		
<b>F362620</b>	28 mm		
<b>F362630</b>	29 mm		
<b>F362640</b>	30 mm		

# LANDANGER

Dilatateurs uterins - Uterine dilators - Dilatadores uterinos

## HEGAR



**F36270**

Boîte complète de 4 à 17 mm  
Complete case from 4 to 17 mm  
Caja completa de 4 a 17 mm

**F36275**

Boîte seule  
Box only  
Caja sólo



**F36280**

Boîte complète de 1 à 26 mm  
Complete case from 1 to 26 mm  
Caja completa de 1 a 26 mm

**F36285**

Boîte seule  
Box only  
Caja sólo

# LANDANGER

## Dilatateurs uterins - Uterine dilators - Dilatadores uterinos



Modèle double  
Double model  
Modelo doble



### HEGAR

### HANK



	Ø
<b>F36400</b>	1 x 2 mm
<b>F36410</b>	3 x 4 mm
<b>F36420</b>	5 x 6 mm
<b>F36430</b>	7 x 8 mm
<b>F36440</b>	9 x 10 mm
<b>F36450</b>	11 x 12 mm
<b>F36460</b>	13 x 14 mm
<b>F36470</b>	15 x 16 mm
<b>F36480</b>	17 x 18 mm
<b>F36485</b>	19 x 20 mm
<b>F36490</b>	21 x 22 mm
<b>F36494</b>	23 x 24 mm
<b>F36498</b>	25 x 26 mm

	Ø
<b>F365050</b>	4,5 x 5 mm
<b>F365060</b>	5,5 x 6 mm
<b>F365070</b>	6,5 x 7 mm
<b>F365080</b>	7,5 x 8 mm
<b>F365090</b>	8,5 x 9 mm
<b>F365100</b>	9,5 x 10 mm

**F36440**  
20 cm - 8"

**F365050**  
27,5 cm - 10<sup>3/4</sup>"

**VIII - 63**

# LANDANGER

Hysteromètres - Uterine sounds - Hysterómetros

3/4

VALLEIX

SIMS



Curseur seul  
Cursor alone  
Cursor solo



**F36310**

**F36300**

28 cm - 11 "



**F36315**

32 cm - 12 1/2 "

**BUSCH  
(VEZIEN)**

- 13 cm - 5 " **B257470**
- 16 cm - 6 1/4 " **B257471**
- 18 cm - 7 " **B257500**

**POUR LE CORDON OMBILICAL  
FOR UMBILICAL CORD  
PARA EL CORDON UMBILICAL**



**B257500**  
18 cm - 7 "



**F05130**  
10,5 cm - 4 "

# LANDANGER

Ciseaux à épisiotomie - Episiotomy scissors - Tijeras episiotomía



DELESTRE

BRAUN-STADLER

14 cm - 5 1/2 " **B257540**

18 cm - 7 " **B257550**



A doigt  
Collin's lock  
Desmontable

**B25755**  
14 cm - 5 1/2 "



**B257550**  
18 cm - 7 "



**B25760**  
14 cm - 5 1/2 "

# LANDANGER

Ciseaux à épisiotomie - Episiotomy scissors - Tijeras episiotomía

WALDMANN

Tungstène    Inox  
Tungsten    Stainless steel  
Tungsteno    Acero inoxidable

19 cm - 7 1/2 "

F05180

F051850

*Prestige*

VAGINAL (TYPE MAYO)  
VAGINAL (STYLE MAYO)  
VAGINAL (TIPO MAYO)



TC Inserts



Supercut



**F05180**  
19 cm - 7 1/2 "



**B86405**  
18 cm - 7 "



**F051900**  
17 cm - 6 3/4 "

**VIII - 67**





Instruments pour voies biliaires - Instruments for bile ducts - Instrumental para vías biliares

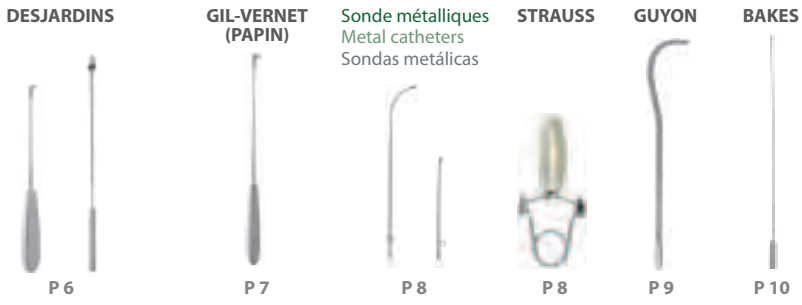
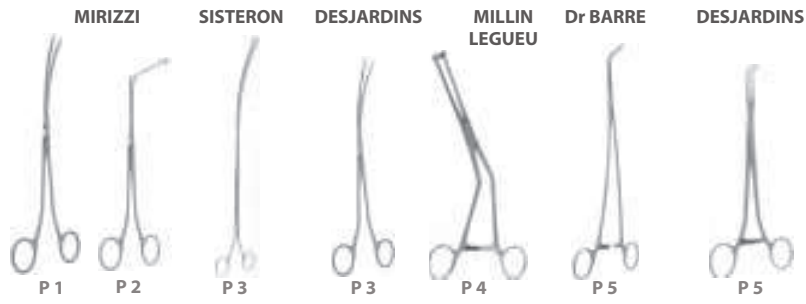





## MIRIZZI

Pinces pour calculs biliaires  
Gall stone forceps  
Pinzas para calculos biliares



**H10010**  
23 cm - 9"

**H10010**  
N° 1

**H10020**  
N° 2

**H10030**  
N° 3

**H10040**  
N° 4

**H10050**  
N° 5

# LANDANGER

Instruments pour voies biliaires - Instruments for bile ducts - Instrumentos para vías biliares



## MIRIZZI

Pinces pour calculs biliaires  
Gall stone forceps  
Pinzas para calculos biliares



N° 6

**H10060**  
23 cm - 9"



**H10070**  
N° 7



**H10080**  
N° 8



**H10090**  
N° 9

**IX - 2**

# LANDANGER

Instruments pour voies biliaires - Instruments for bile ducts - Instrumentos para vías biliares



2/3

**SISTERON**



**H10100**

40 cm - 15 3/4"

Pinces pour calculs biliaires  
Gall stone forceps  
Pinzas para calculos biliares

**DESJARDINS**



1/1

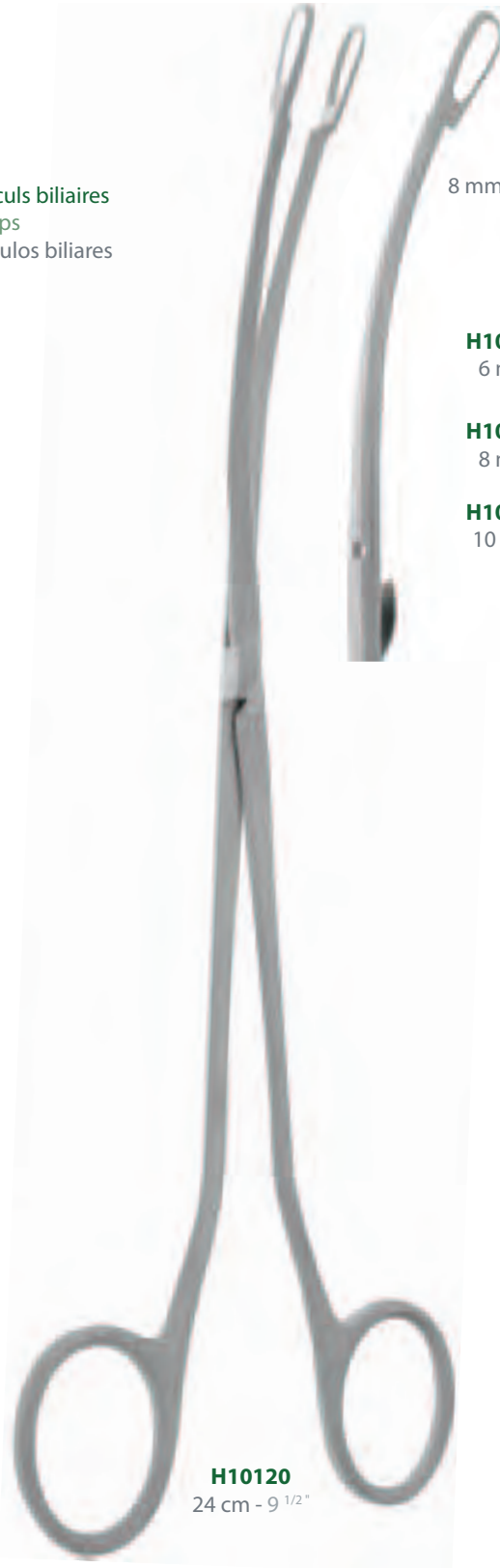

**H10120**

24 cm - 9 1/2"

8 mm

**H10115**

6 mm

**H10120**

8 mm

**H10130**

10 mm

**IX - 3**

# LANDANGER

Instruments pour voies biliaires - Instruments for bile ducts - Instrumentos para vías biliares



**H10140**  
23 cm - 9"

**IX - 4**

## MILLIN



**H10140**  
23 cm - 9"



**H10145**  
23 cm - 9"



**H10150**  
23 cm - 9"

## LEGUEU



**H10155**  
20 cm - 8"

Dr BARRE

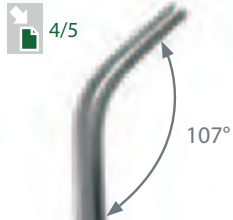

Pince à ailerons vésicaux  
Vesical forceps  
Pinzas para alabes vesicales



**H10175**  
29 cm - 11 1/2"

DESJARDINS



Pince à cystique  
Cystic forceps  
Pinzas para cistico

**H20010**  
21 cm - 8 1/4"

# LANDANGER

Instruments pour voies biliaires - Instruments for bile ducts - Instrumentos para vías biliares



## DESJARDINS

Curette  
Curette  
Cureta

**H20025**  
4 mm

**H20030**  
6 mm

**H20040**  
8 mm

**H20050**  
10 mm

**H20060**  
12 mm



**H20025**  
26 cm - 10<sup>1/4</sup>''

Explorateur  
Probe  
Explorador

**H20070**  
4 mm

**H20071**  
6 mm

**H20072**  
8 mm



**H20071**  
27 cm - 10<sup>3/4</sup>''

Drague  
Scoop  
Draga

**H20080**  
6 mm

**H20081**  
7 mm

**H20082**  
8 mm

**H20083**  
9 mm



**H20080**  
30 cm - 11<sup>3/4</sup>''



## GIL-VERNET (PAPIN)

Ecarteur - Retractor - Separador

Rigide	Malleable
Rigid	Malleable
Rigida	Maleable

10 mm	<b>H20085</b>	<b>H20087</b>
15 mm	<b>H20089</b>	<b>H20091</b>
20 mm	<b>H20093</b>	<b>H20095</b>



10 mm



**H20085**

15 mm

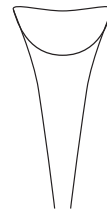

**H20089**

20 mm

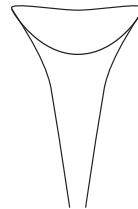

**H20093**

**H20085**  
28 cm - 11 "

# LANDANGER

Instruments pour voies biliaires - Instruments for bile ducts - Instrumentos para vías biliares



## SONDES MÉTALLIQUES METAL CATHETERS SONDAS METÁLICAS

Homme  
Men  
Hombres

Femme  
Women  
Mujeres

**H251010** CH 10 - 3,3 mm **H251110**

**H251012** CH 12 - 4,0 mm **H251112**

**H251016** CH 16 - 5,3 mm **H251116**

**H251018** CH 18 - 6,0 mm -

## STRAUSS

Compresseur de l'urètre  
Urethra compressor  
Compresor para pene



**H251012**  
25 cm - 10 "

**H251112**  
15 cm - 6 "



**H20110-0**  
10,5 cm - 4 1/8 "

## GUYON

Cathéter courbe (beniqué)  
Curved dilating bougie  
Bujía dilatadora curva

	Ø
H250140	2.3 mm / CH07
H250160	2.6 mm / CH08
H250180	3.0 mm / CH09
H250200	3.3 mm / CH10
H250220	3.6 mm / CH11
H250240	4.0 mm / CH12
H250260	4.3 mm / CH13
H250280	4.6 mm / CH14
H250300	5.0 mm / CH15
H250320	5.3 mm / CH16
H250340	5.6 mm / CH17
H250360	6.0 mm / CH18
H250380	6.3 mm / CH19
H250400	6.6 mm / CH20
H250420	7.0 mm / CH21
H250440	7.3 mm / CH22
H250460	7.6 mm / CH23
H250480	8.0 mm / CH24
H250500	8.3 mm / CH25
H250520	8.6 mm / CH26
H250540	9.0 mm / CH27
H250560	9.3 mm / CH28
H250580	9.6 mm / CH29
H250600	10.0 mm / CH30



**H250480**  
27 cm - 10<sup>3/4</sup> "

# LANDANGER

Instruments pour voies biliaires - Instruments for bile ducts - Instrumentos para vías biliares



## BAKES

Dilatateur pour voies biliaires  
Dilatators for bile ducts  
Dilatadores para vías biliares



**H40010**  
1 mm



**H40020**  
2 mm



**H40030**  
3 mm



**H40040**  
4 mm

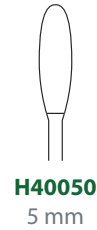

**H40050**  
5 mm

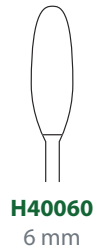

**H40060**  
6 mm



**H40070**  
7 mm



**H40080**  
8 mm



**H40090**  
9 mm

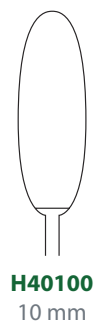

**H40100**  
10 mm



**H40110**  
11 mm



**H40120**  
12 mm



**H40130**  
13 mm



**H40030**  
30 cm - 11 3/4 "

Microchirurgie porte-aiguilles - Microsurgery needle holders - Microcirugía porta-agujas

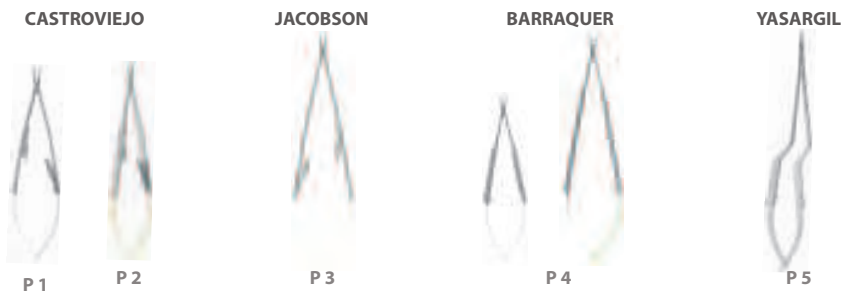

Microchirurgie ciseaux - Microsurgery scissors - Microcirugía tijeras



Microchirurgie pincettes - Microsurgery fine forceps - Microcirugía pinzas pequeñas

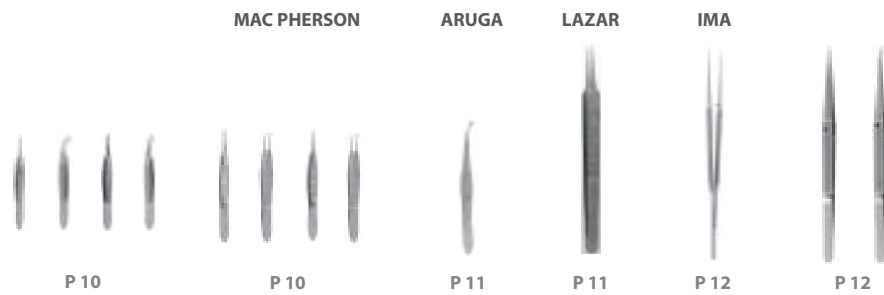

Microchirurgie pinces corps étrangers - Microsurgery forceps loose foreign body - Microcirugía pinzas cuerpo extraño

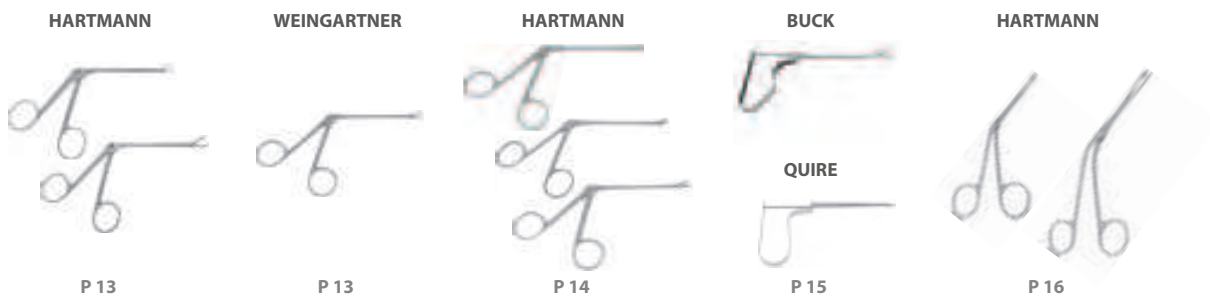

Microchirurgie crochets - Microsurgery hooks - Microcirugía ganchos

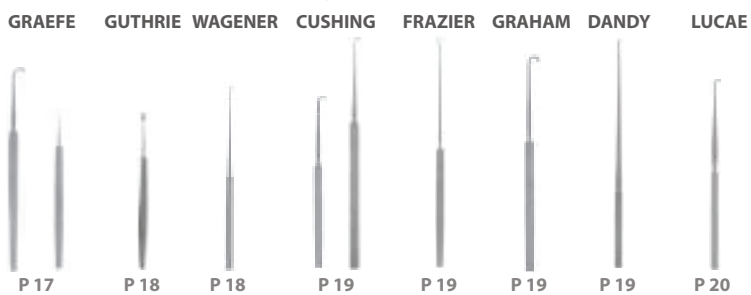

Divers - Miscellaneous - Diversos



VII - Écarteurs  
VII - Retractors  
VII - Separadores

Crochets - Hooks - Ganchos

BERGMANN LERICHE JOSEPH GILLIES



XII - O.R.L.  
XII - E.N.T.  
XII - O.R.L.

O.R.L. crochets - E.N.T. hooks - O.R.L. ganchos

FREER FOMON COTTLE FRAZIER JOSEPH

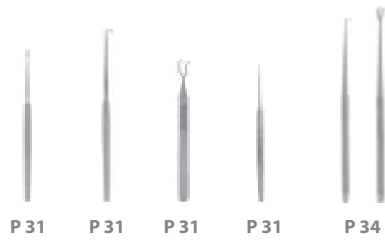

# LANDANGER

Microchirurgie porte-aiguilles - Microsurgery needle holders - Microcirugía porta-agujas



## CASTROVIEJO

Mors lisses  
Smooth jaws  
Boca lisa

Mors striés  
Stria jaws  
Boca estriada

14 cm - 5 1/2 "

**D01010**

**D010110**

Mors lisses  
Smooth jaws  
Boca lisa

Mors striés  
Stria jaws  
Boca estriada

14 cm - 5 1/2 "

**D01020**

**D010210**

Droit  
Straight  
Recto



**D01010**  
14 cm - 5 1/2 "

Courbe  
Curved  
Curvo



**D01020**  
14 cm - 5 1/2 "

# LANDANGER

## Microchirurgie porte-aiguilles - Microsurgery needle holders - Microcirugía porta-agujas



### CASTROVIEJO

Mors lisses  
Smooth jaws  
Boca lisa

Mors striés  
Stria jaws  
Boca estriada

Mors lisses  
Smooth jaws  
Bocca liso

Mors striés  
Stria jaws  
Estriado bocca

14 cm - 5 1/2 "

**D010290**

**D01030**

14 cm - 5 1/2 "

**D010390**

**D01040**



Droit  
Straight  
Recto



Courbe  
Curved  
Curvo



**D01030**

14 cm - 5 1/2 "

**D01040**

14 cm - 5 1/2 "



# LANDANGER

Microchirurgie porte-aiguilles - Microsurgery needle holders - Microcirugía porta-agujas

## JACOBSON



Droit  
Straight  
Recto

Courbe  
Curved  
Curvo

18 cm - 7 "

D010440

D010460



18 cm - 7 "

D01050

D010550

TC Inserts



Mors striés  
Stria jaws  
Boca estriada

D01050  
18 cm - 7 "

X - 3

X - Microchirurgie  
X - Microsurgery  
X - Microcirugía

# LANDANGER

## Microchirurgie porte-aiguilles - Microsurgery needle holders - Microcirugía porta-agujas



### BARRAQUER

Mors lisses Smooth jaws Boca lisa	Droit Straight Recto	Courbe Curved Curvo
13 cm - 5 "	D01060	D01070
18 cm - 7 "	D01090	D01100

Mors striés Stria jaws Boca estriada		
TC Inserts  14 cm - 5 1/2 "	D010790	D01080
18 cm - 7 "	D011100	D011110



**D01060**  
13 cm - 5 1/2 "



**D011100**  
18 cm - 7 "

# LANDANGER

Microchirurgie porte-aiguilles - Microsurgery needle holders - Microcirugía porta-agujas



## YASARGIL

	Droit Straight Recto	Courbe Curved Curvo
18 cm - 7 "	<b>D012000</b>	<b>D012010</b>
22,5 cm - 8 <sup>3</sup> / <sub>4</sub> "	<b>D012020</b>	<b>D012030</b>



D012000

D012010

**D012000**  
18 cm - 7 "

# LANDANGER

Microchirurgie ciseaux - Microsurgery scissors - Microcirugía tijeras



## VANNAS

Droit Straight Recta	Courbe Curved Curva	Coudé Angled Angulada
----------------------------	---------------------------	-----------------------------

8.5 cm - 3 1/2"

**D020010**

**D020020**

**D020030**



**D020010**



**D020020**



**D020030**

**D020010**

8,5 cm - 3 1/4 "

# LANDANGER

## Microchirurgie ciseaux - Microsurgery scissors - Microcirugía tijeras

Corps rond  
Round body  
Cuerpo redondo



Droit Straight Recta	Pointu Sharp Aguda	Pointu, fin Sharp, fine Aguda, fina	Pointu, dentelé Sharp, serrated Aguda, dentellada
----------------------------	--------------------------	---	---

14 cm - 5 1/2 "	<b>D020090</b>	-	-
16 cm - 6 1/4 "	-	<b>D020210</b>	<b>D020220</b>
18 cm - 7 "	<b>D020290</b>	-	-

Courbe Curved Curva	Pointu Sharp Aguda	Mousse Blunt Roma	Pointu, fin Sharp, fine Aguda, fina	Pointu, dentelé Sharp, serrated Aguda, dentellada
---------------------------	--------------------------	-------------------------	---	---

14 cm - 5 1/2 "	<b>D02010</b>	<b>D02020</b>	-	-
16 cm - 6 1/4 "	-	-	<b>D020211</b>	<b>D020221</b>
18 cm - 7 "	<b>D02030</b>	-	-	-

Coudé Angular Angulada	Pointu Sharp Aguda
------------------------------	--------------------------

18 cm - 7 "	<b>D020310</b>
-------------	----------------



**D020310**



**D02020**  
14 cm - 5 1/2 "



**D020090**



**D02010**



**D02020**

# LANDANGER

## Microchirurgie ciseaux - Microsurgery scissors - Microcirugía tijeras



Corps plat  
Flat body  
Cuerpo llano

Droit Straight Recta	Pointu Sharp Aguda	Pointu, fin Sharp, fine Aguda, fina	Pointu, dentelé Sharp, serrated Aguda, dentellada
16 cm - 6 1/4 "	<b>D020400</b>	<b>D020410</b>	<b>D020420</b>
Courbe Curved Curva	Pointu Sharp Aguda	Pointu, fin Sharp, fine Aguda, fina	Pointu, dentelé Sharp, serrated Aguda, dentellada
16 cm - 6 1/4 "	<b>D020401</b>	<b>D020411</b>	<b>D020421</b>



# LANDANGER

Microchirurgie ciseaux - Microsurgery scissors - Microcirugía tijeras

YASARGIL



Droit Straight Recta	Pointu Sharp Aguda	Mousse Blunt Roma
16,5 cm - 6 1/2 "	<b>D020430</b>	-
20 cm - 8 "	<b>D020440</b>	<b>D020442</b>
22,5 cm - 8 3/4 "	<b>D020450</b>	<b>D020452</b>

Courbe Curved Curva	Pointu Sharp Aguda	Mousse Blunt Roma
16,5 cm - 6 1/2 "	<b>D020431</b>	-
20 cm - 7 3/4 "	<b>D020441</b>	<b>D020443</b>
22,5 cm - 8 3/4 "	<b>D020451</b>	<b>D020453</b>



**D020440**



**D020442**



**D020430**  
20 cm - 8 "



**D020441**



**D020443**

X - Microchirurgie  
X - Microsurgery  
X - Microcirugía

# LANDANGER

## Microchirurgie pincettes - Microsurgery fine forceps - Microcirugía pinzas pequeñas



X - Microchirurgie  
X - Microsurgery  
X - Microcirugía

	Sans griffes Without teeth Sin dientes	7 cm - 2 3/4"	A griffes With teeth Con dientes	
Droite Straight Recta		Courbe Curved Curva	Droite Straight Recta	Courbe Curved Curva
				
<b>D03060</b>		<b>D03070</b>	<b>D03080</b>	<b>D03090</b>

## MAC PHERSON

	Sans griffes Without teeth Sin dientes	8 cm - 3 1/4"	A griffes With teeth Con dientes	
Droite Straight Recta		Coudée Angled Angulada	Droite Straight Recta	Coudée Angled Angulada
				
<b>D03120</b>		<b>D03130</b>	<b>D03100</b>	<b>D03110</b>

**X - 10**



# LANDANGER

Microchirurgie pincettes - Microsurgery fine forceps - Microcirugía pinzas pequeñas



## ARRUGA

Pince capsulaire  
Capsule forceps  
Pinza capsular



**D03160**  
10 cm - 4 "

## LAZAR



**D031400**  
15,5 cm - 6 "

0,5 mm



**D031400**  
15,5 cm - 6 "

0,8 mm



**D031405**  
15,5 cm - 6 "

# LANDANGER

## Microchirurgie pinces fines - Microsurgery fine forceps - Microcirugía pinzas finas



### IMA

Corps rond  
Round body  
Cuerpo redondo

Corps rond  
Round body  
Cuerpo redondo

Droite  
Straight  
Recta

Courbe  
Curved  
Curva

**D031410**

12 cm - 4 3/4 "

**D031411**

**D031420**

15 cm - 6 "

**D031421**

**D031430**

18 cm - 7 "

**D031431**



**D031440**  
18 cm - 7 "



**D031430**  
18 cm - 7 "



**D031431**  
18 cm - 7 "



# LANDANGER

Microchirurgie pinces corps étrangers - Microsurgery forceps loose foreign body - Microcirugía pinzas para cuerpos extraños



## HARTMANN



Sans griffes  
Without teeth  
Sin dientes

**D03170**  
8,5 cm - 3 1/4 "

**D03190**  
14 cm - 5 1/2 "

A griffes  
With teeth  
Con dientes

**D03180**  
8,5 cm - 3 1/4 "

**D03191**  
14 cm - 5 1/2 "

## HARTMANN-WEINGARTNER



**D03192**  
8,5 cm - 3 1/4 "

X - Microchirurgie  
X - Microsurgery  
X - Microcirugía

# LANDANGER

Microchirurgie pinces à polypes - Microsurgery fine forceps polypus - Microcirugía pinzas finas para pólipos



## HARTMANN



**D032000**

Ø 2 mm

8,5 cm - 3 1/4"

**D032010**

Ø 3 mm

8,5 cm - 3 1/4"

## HARTMANN CITELLI



**D032020**

Ø 2 mm

8,5 cm - 3 1/4"

**D032030**

Ø 3 mm

8,5 cm - 3 1/4"

## HARTMANN

Pince rongeur  
Bone forceps  
Pinza gubia



**D033000**

Ø 2 mm

8,5 cm - 3 1/4"

# LANDANGER

Microchirurgie pincers corps étrangers - Microsurgery forceps loose foreign body - Microcirugía pinzas para cuerpos extraños



## BUCK



**D034000**  
11 cm - 4 1/4"

## QUIRE



**D034010**  
10 cm - 4"

X - Microchirurgie  
X - Microsurgery  
X - Microcirugía

# LANDANGER

Pinces corps étrangers et polypes - Forceps loose foreign body and polypus - Pinzas para cuerpos extraños and pólipos



## HARTMANN

12 cm - 4 <sup>3</sup> / <sub>4</sub> "	D035000
14 cm - 5 <sup>1</sup> / <sub>2</sub> "	D035010
16 cm - 6 <sup>1</sup> / <sub>4</sub> "	D035020
20 cm - 8 "	D035030



**D035000**  
12 cm - 4 <sup>3</sup>/<sub>4</sub> "



**D035020**  
16 cm - 6 <sup>1</sup>/<sub>4</sub> "

## GRAEFE

Mousse  
Blunt  
Romo



**D040210**  
13,5 cm - 5 1/4"



**D040211**  
14 cm - 5 1/2"



**D040212**  
14,5 cm - 5 3/4"

Mousse  
Blunt  
Romo



**D04010**  
12 cm - 4 3/4"

Pointu  
Sharp  
Agudo



**D04020**  
12 cm - 4 3/4"

# LANDANGER

## Microchirurgie crochets - Microsurgery hooks - Microcirugía ganchos



### GUTHRIE

### WAGENER

Fin  
Fine  
Fino

Fort  
Strong  
Fuerte

2.5 mm

3 mm

Fin  
Fine  
Fino

3 mm

Fin  
Fine  
Fino

Fort  
Strong  
Fuerte



**D04040**  
13 cm - 5 "

**D040410**  
16 cm - 6 1/4 "

**D040411**  
16 cm - 6 1/4 "

**D04060**  
14 cm - 5 1/2 "

**D04050**  
14 cm - 5 1/2 "



# LANDANGER

Microchirurgie crochets - Microsurgery hooks - Microcirugía ganchos



CUSHING



Pointu  
Sharp  
Agudo

**D040420**  
14 cm - 5 1/2"

FRAZIER



Mousse  
Blunt  
Romo

**J16240**  
19 cm - 7 1/2"

GRAHAM



**D040440**  
13 cm - 5"

**D040441**  
18 cm - 7"

**D040700**  
16,5 cm - 6 1/2"

DANDY



**D040710**  
22 cm - 8 1/2"

X - Microchirurgie  
X - Microsurgery  
X - Microcirugía

# LANDANGER

Microchirurgie divers - Microsurgery miscellaneous - Microcirugía diverso



## LUCAE

## CASTROVIEJO

Petit  
Small  
Pequeñas

Moyen  
Medium  
Medianas

Grand  
Large  
Grandes

Porte lame  
Blade holder  
Porta hoja



**D040800**  
14 cm - 5 1/2"



**D040801**  
14 cm - 5 1/2"



**D040802**  
14 cm - 5 1/2"



**D02050**  
13 cm - 5"

Boite de 10 lames  
Box of 10 blades  
Caja de 10 hojas



**D02060**

**X - 20**

Instruments pour sciatique - Instruments for sciatic - Instrumentos para ciática

CLOVIS-VINCENT SICART CAIRNS CREED

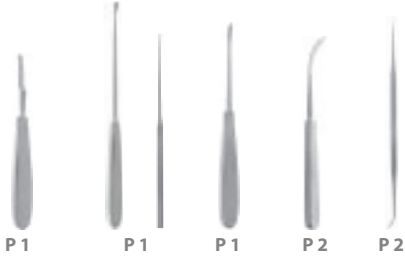

Neurochirurgie : spatule - Neurosurgery : spatula - Neurocirugía : espátula

CLOVIS-VINCENT CUSHING OLIVECRONA HEIFETZ

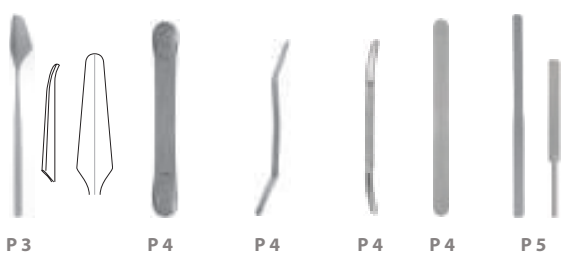

Neurochirurgie : écarteur - Neurosurgery : retractor - Neurocirugía : separador

HOLSHER TAYLOR

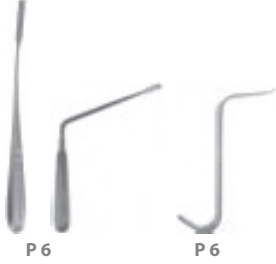

Neurochirurgie : perforateur - Neurosurgery : bone drill - Neurocirugía : perforador

DOYEN HUDSON

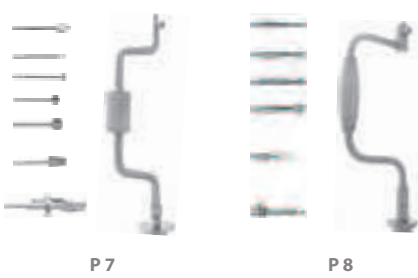

Neurochirurgie : dissecteurs - Neurosurgery : dissectors - Neurocirugía : disecadores

DE MARTEL DAVIS CRILE CUSHING ABOLKER RIZZUTI ROBB CARPENTER



Neurochirurgie : pinces rongeurs - Neurosurgery : laminectomy rongeurs - Neurocirugía : pinzas para laminectomía

CUSHING  
LOVE-GRUENWALD  
SPURLING



FERRIS-SMITH-CUSHING



WEIL-BLAKESLEY



☒

Neuro chirurgie : emporte pièces - Neurosurgery : punches - Neurocirugía : sacabocados

FERRIS-SMITH-KERRISSON



P 15 - P 16 - P 17

Écarteurs neuro - Neuro retractors - Separadores neuro

WEITLANER



P 90

WEITLANER  
WULLSTEIN



P 90

WEITLANER  
NEURO



P 91

MARKHAM  
MEYERDING



☒

WALTON



ADSON



INGE-MEHARY



VII - Écarteurs  
VII - Retractors  
VII - Separadores

CLOWARD



P 96

CLOWARD



P 97

CLOWARD

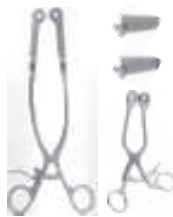

P 98

VII - Écarteurs  
VII - Retractors  
VII - Separadores

# LANDANGER

Instruments pour sciatique - Instruments for sciatic - Instrumentos para ciática



## CLOVIS VINCENT

5 mm **J08030**

7 mm **J08031**

## SICART

17 cm - 6 <sup>3</sup>/<sub>4</sub> " **J08010**

19 cm - 7 <sup>1</sup>/<sub>2</sub> " **J08011**



Rugine  
Raspatory  
Raspador

**J08010**  
17 cm - 6 <sup>3</sup>/<sub>4</sub> "



Curette  
Curette  
Cureta

**J08030**  
22 cm - 8 <sup>3</sup>/<sub>4</sub> "

4 mm



Crochet  
Hook  
Gancho

**J08035**  
19 cm - 7 <sup>1</sup>/<sub>2</sub> "



**J08060**  
20 cm - 8 "

**XI - 1**

# LANDANGER

Instruments pour sciatique - Instruments for sciatic - Instrumentos para ciática



## CAIRNS (CLOVIS VINCENT)



**J08070**  
19 cm - 7 1/2"

## CREED



**J08080**  
21 cm - 8 1/4"

**XI - 2**

XI - Neurochirurgie  
XI - Neurosurgery  
XI - Neurocirugía

# LANDANGER

Neurochirurgie : spatule - Neurosurgery : spatula - Neurocirugía : espátula



## CLOVIS VINCENT



**J150140**  
20 cm - 8"

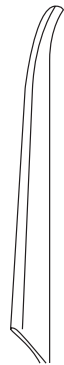

**D J150130**  
21 cm - 8 1/4"

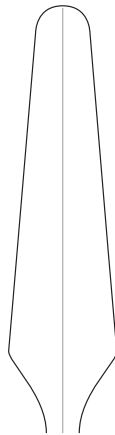

**C J150120**  
21 cm - 8 1/4"

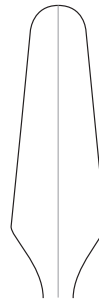

**B J150110**  
19 cm - 7 1/2"



**A J150100**  
18 cm - 7"

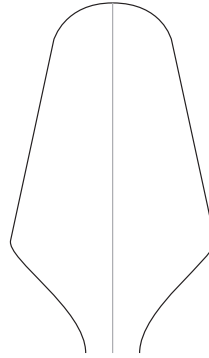

**F J150140**  
20 cm - 8"

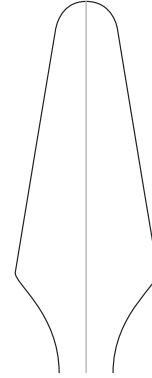

**L J150190**  
20 cm - 8"

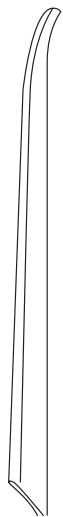

**K J150180**  
23,5 cm - 9 1/4"

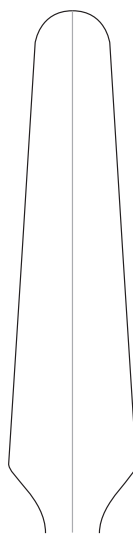

**J J150170**  
23,5 cm - 9 1/4"

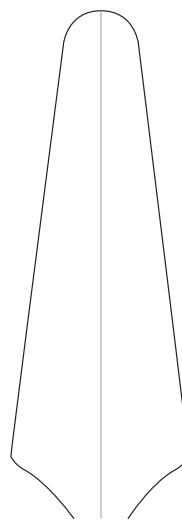

**I J150160**  
23,5 cm - 9 1/4"

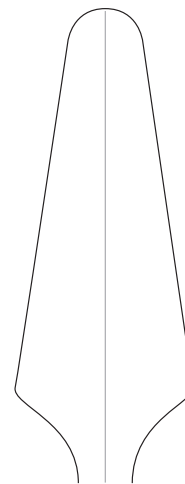

**G J150150**  
22 cm - 8 3/4"

# LANDANGER

Neurochirurgie : spatule - Neurosurgery : spatula - Neurocirugía : espátula



## CUSHING

17 cm - 6 1/2"

**J151001**

20 cm - 7 3/4"

**J151002**

## OLIVECRONA

7 x 9 mm

**J151010**

11 x 13 mm

**J151011**

15 x 18 mm

**J151012**

18 x 22 mm

**J151013**

## Lame malléable - Malleable spatula - Espátula maleable

7 x 9 mm

**J151020**

11 x 13 mm

**J151021**

15 x 18 mm

**J151022**

18 x 22 mm

**J151023**

12 mm

**J151030**

17 mm

**J151031**



**J151002**  
20 cm - 8"

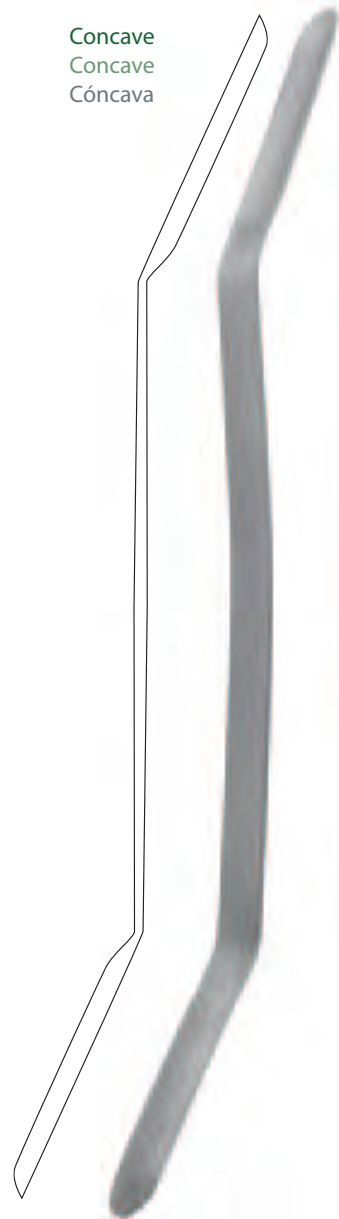

**J151010**  
18 cm - 7"

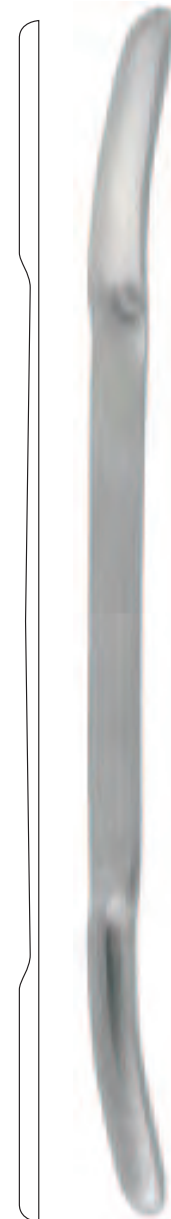

**J151021**  
18 cm - 7"



**J151031**  
20 cm - 8"

**XI - 4**

XI - Neurochirurgie  
XI - Neurosurgery  
XI - Neurocirugía



## HEIFETZ



7 x 8 mm	<b>J151040</b>
10 x 11 mm	<b>J151041</b>
13 x 14 mm	<b>J151042</b>
16 x 17 mm	<b>J151043</b>
19 x 20 mm	<b>J151044</b>
22 x 25 mm	<b>J151045</b>

8 mm	<b>J151050</b>
11 mm	<b>J151051</b>
14 mm	<b>J151052</b>
17 mm	<b>J151053</b>

Lame malléable  
Malleable spatula  
Espátula maleable



**J151041**  
20 cm - 8"



**J151051**  
15,5 cm - 6"

# LANDANGER

Neurochirurgie : écarteur - Neurosurgery : retractor - Neurocirugía : separadores

4/5

## HOLSHER

Courbe  
Curved  
Curvo

12 mm **J152100**

17 mm **J152101**



**J152100**  
24 cm - 9 1/2 "

Coudé  
Angled  
Angulado

12 mm **J152110**

17 mm **J152111**



**J152111**  
20 cm - 8 "

## TAYLOR

30 x 70 mm **J152120**

30 x 100 mm **J152121**



**J152120**  
17 cm - 6 3/4 "

XI - Neurochirurgie  
XI - Neurosurgery  
XI - Neurocirugía

## DOYEN



Perforateur initial  
Initial drill  
Perforador inicial



**J16020**

### DOYEN



**J16030**

4 mm



**J16040**

8 mm



**J16050**

12 mm



**J16060**

16 mm

### CLOVIS VINCENT



**J16065**

14 mm

### DOYEN (Couronne de Trépan)



15 mm	<b>J16075</b>
20 mm	<b>J160760</b>
25 mm	<b>J160770</b>
30 mm	<b>J160780</b>
35 mm	<b>J160790</b>



Perforateur seul  
Drill only  
Perforador sólo

**J16010**

# LANDANGER

Neurochirurgie : perforateur - Neurosurgery : bone drill - Neurocirugía : perforador

3/4

HUDSON

Perforateur initial  
Initial drill  
Perforador inicial

1/2



**J161010**  
9 mm

**J161020**  
14 mm

**J161030**  
16 mm

**J161040**  
22 mm

**CUSHING**

**J161050**

Rallonge  
Extension piece  
Pieza alargadera



**J161060**



Perforateur seul  
Drill only  
Perforador sólo

**J161000**

# LANDANGER

Neurochirurgie : dissecteurs - Neurosurgery : dissectors - Neurocirugía : disecadores



## DE MARTEL

## DAVIS

## CRILE

## CUSHING

Mousse  
Blunt  
Romo

6 mm

8 mm

4 mm

6 mm

90°

90°

90°

**J162200**  
21 cm - 8 1/4 "

**J16230**  
24 cm - 9 1/2 "

**J162350**  
20 cm - 8 "

**J16240**  
19 cm - 7 1/2 "  
**J162410**  
28 cm - 11 "

**J16245**  
6 mm  
19 cm - 7 1/2 "

**J162460**  
7,5 mm  
28 cm - 11 "

**XI - 9**

# LANDANGER

Neurochirurgie : dissecteurs - Neurosurgery : dissectors - Neurocirugía : disecadores



## ABOULKER

## ABOULKER

## RIZZUTI

Fine légèrement courbe  
Fine slightly curved  
Fino ligeramente curvo

Fine 1/2 courbe  
Fine 1/2 curved  
Fino medio curvo

Fine très courbe  
Fine very curved  
Fino muy curvo

3,5 mm

3,5 mm

4,0 mm

4,0 mm



**J16250**  
3,5 mm  
20 cm - 8"

**J16255**  
5 mm  
20 cm - 8"

**J162561**  
21 cm - 8 1/4"

**J162563**  
21 cm - 8 1/4"

**J162565**  
22 cm - 8 3/4"

**J16260**  
20 cm - 8"

**J16265**  
25 cm - 10"

# LANDANGER

Neurochirurgie : dissecteurs - Neurosurgery : dissectors - Neurocirugía : disecadores

## ROBB

## CARPENTER



XI - Neurochirurgie  
XI - Neurosurgery  
XI - Neurocirugía

# LANDANGER

Neurochirurgie : pinces rongeurs - Neurosurgery : laminectomy rongeurs - Neurocirugía : pinzas para laminectomía



J17001



## CUSHING

Largueur de mors Width of jaw Anchura de boca	Longueur de la tige Length of shaft Largo del tallo	Droite Straight Recta	Vers le haut Upward Hacia arriba	Vers le bas Downward Hacia bajo
2 x 10 mm 	13 cm - 5 1/8 "	J17001	J17002	J17003
	15 cm - 6 "	J170040	J170041	J170042
	18 cm - 7 "	J17005	J17006	J17007

## LOVE-GRUENWALD

Largueur de mors Width of jaw Anchura de boca	Longueur de la tige Length of shaft Largo del tallo	Droite Straight Recta	Vers le haut Upward Hacia arriba	Vers le bas Downward Hacia bajo
3 x 10 mm 	13 cm - 5 1/8 "	J17010	J17012	J17015
	15 cm - 6 "	J170160	J170161	J170162
	18 cm - 7 "	J17020	J17025	J17035

## SPURLING

Largueur de mors Width of jaw Anchura de boca	Longueur de la tige Length of shaft Largo del tallo	Droite Straight Recta	Vers le haut Upward Hacia arriba	Vers le bas Downward Hacia bajo
4 x 10 mm 	13 cm - 5 1/8 "	J17045	J17050	J17055
	15 cm - 6 "	J170560	J170561	J170562
	18 cm - 7 "	J17060	J17065	J17070





# LANDANGER

Neurochirurgie : pinces rongeurs - Neurosurgery : laminectomy rongeurs - Neurocirugía : pinzas para laminectomía

 2/3

## FERRIS-SMITH-CUSHING



	Largeur de mors Width of jaw Anchura de boca	Longueur de la tige Length of shaft Largo del tallo	Droite Straight Recta	Vers le haut Upward Hacia arriba	Vers le bas Downward Hacia bajo
	2 x 10 mm	18 cm - 7 "	J170750	J170751	J170752
	3 x 10 mm	18 cm - 7 "	J17080	J17085	J170860
	4 x 10 mm	18 cm - 7 "	J17090	J170898	J170899

XI - Neurochirurgie  
 XI - Neurosurgery  
 XI - Neurocirugía

# LANDANGER

Neurochirurgie : pinces rongeurs - Neurosurgery : laminectomy rongeurs - Neurocirugía : pinzas para laminectomía



## WEIL-BLAKESLEY



J170905



	Largueur de mors Width of jaw Anchura de boca	Longueur de la tige Length of shaft Largo del tallo	Droite Straight Recta	Vers le haut Upward Hacia arriba
	3,0 mm	12 cm - 4 <sup>3</sup> / <sub>4</sub> "	J170901	J170902
	3,5 mm	12 cm - 4 <sup>3</sup> / <sub>4</sub> "	J170903	J170904
	4,5 mm	12 cm - 4 <sup>3</sup> / <sub>4</sub> "	J170905	J170906
	5,0 mm	12 cm - 4 <sup>3</sup> / <sub>4</sub> "	J170907	J170908

# LANDANGER



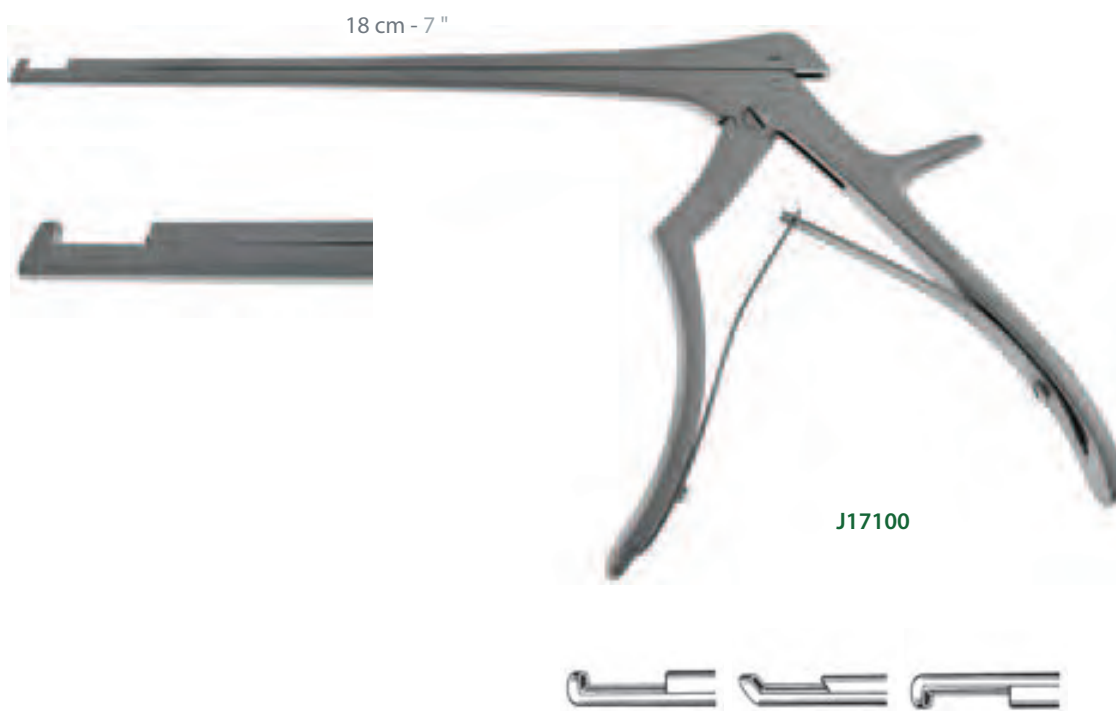

Neurochirurgie : emporte pièces - Neurosurgery : punches - Neurocirugía : sacabocados

## FERRIS SMITH KERRISSON

 2/3



J17100

Largeur de mors Width of jaw Anchura de boca	Longueur de la tige Length of shaft Largo del tallo	90° Vers le haut 90° Upward 90° Hacia arriba	40° Vers le haut 40° Upward 40° Hacia arriba	90° Vers le bas 90° Downward 90° Hacia bajo
1 mm 	18 cm - 7 "	J170940	J171170	J171821
	20 cm - 8 "	-	-	-
	28 cm - 11 "	-	-	-
2 mm 	18 cm - 7 "	J17095	J17118	J171822
	20 cm - 8 "	-	-	-
	28 cm - 11 "	-	-	-
3 mm 	18 cm - 7 "	J17100	J17120	J171823
	20 cm - 8 "	J172003	J172013	J172023
	28 cm - 11 "	J172803	J172813	-
4 mm 	18 cm - 7 "	J17110	J17130	J171824
	20 cm - 8 "	J172004	J172014	J172024
	28 cm - 11 "	J172804	J172814	-
5 mm 	18 cm - 7 "	J17115	J17140	J171825
	20 cm - 8 "	J172005	J172015	J172025
	28 cm - 11 "	J172805	J172815	-





# LANDANGER

Neurochirurgie : emporte pièces - Neurosurgery : punches - Neurocirugía : sacabocados

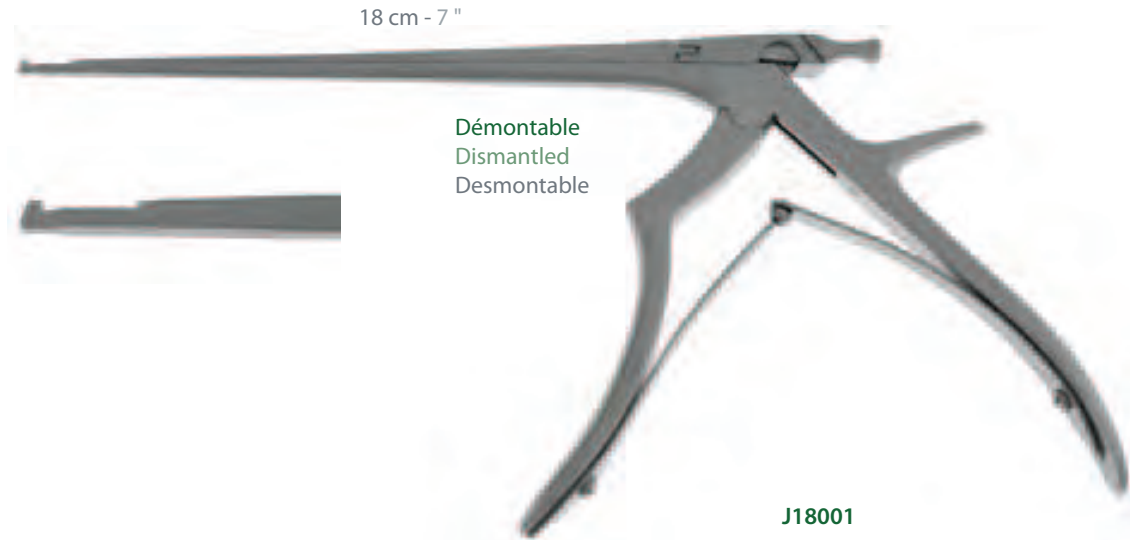
2/3

## FERRIS-SMITH-KERRISSON



Largueur de mors Width of jaw Anchura de boca	Longueur de la tige Length of shaft Largo del tallo	90° Vers le haut 90° Upward 90° Hacia arriba	40° Vers le haut 40° Upward 40° Hacia arriba	90° Vers le bas 90° Downward 90° Hacia bajo
1 mm 	18 cm - 7 "	<b>J18001</b>	<b>J18041</b>	-
2 mm 	18 cm - 7 "	<b>J18002</b>	<b>J18042</b>	-
3 mm 	18 cm - 7 "	<b>J18003</b>	<b>J18043</b>	<b>J18103</b>
4 mm 	18 cm - 7 "	<b>J18004</b>	<b>J18044</b>	-
5 mm 	18 cm - 7 "	<b>J18005</b>	<b>J18045</b>	<b>J18105</b>

# LANDANGER

Neuro chirurgie : emporte pièces - Neurosurgery : punches - Neurocirugía : sacabocados



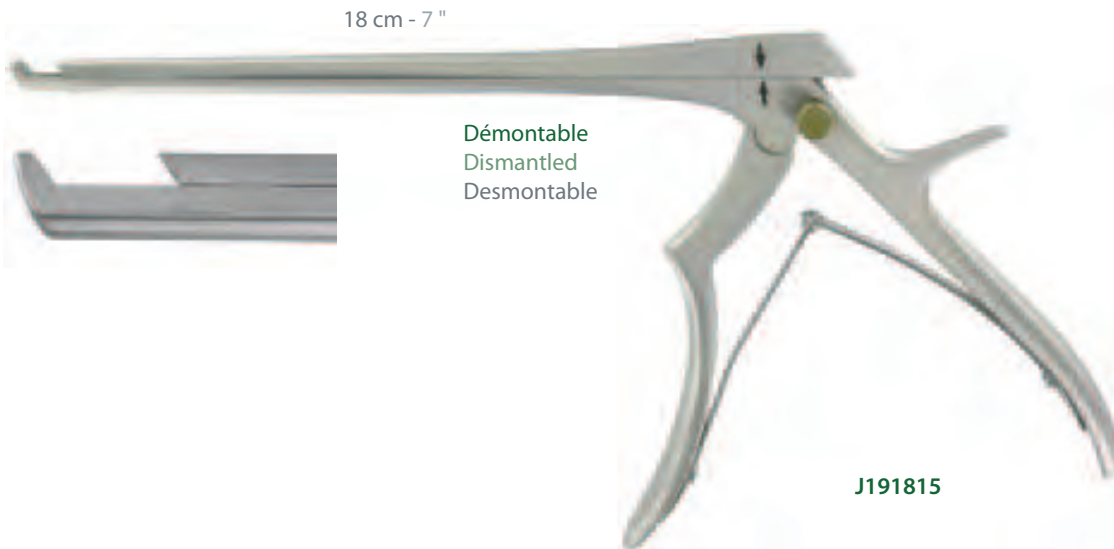

2/3

## FERRIS-SMITH-KERRISSON



XI - Neurochirurgie  
XI - Neurosurgery  
XI - Neurocirugía



Largueur de mors Width of jaw Anchura de boca	Longueur de la tige Length of shaft Largo del tallo	90° Vers le haut 90° Upward 90° Hacia arriba	40° Vers le haut 40° Upward 40° Hacia arriba
1 mm 	18 cm - 7 "	<b>J191801</b>	<b>J191811</b>
	20 cm - 8 "	-	-
2 mm 	18 cm - 7 "	<b>J191802</b>	<b>J191812</b>
	20 cm - 8 "	-	-
3 mm 	18 cm - 7 "	<b>J191803</b>	<b>J191813</b>
	20 cm - 8 "	<b>J192003</b>	<b>J192013</b>
4 mm 	18 cm - 7 "	<b>J191804</b>	<b>J191814</b>
	20 cm - 8 "	<b>J192004</b>	<b>J192014</b>
5 mm 	18 cm - 7 "	<b>J191805</b>	<b>J191815</b>
	20 cm - 8 "	<b>J192005</b>	<b>J192015</b>



O.R.L. ouvre-bouche - E.N.T. mouth gag - O.R.L. abre-boca

DELABARRE TERRIER ODWYER DOYEN JEANNINGS DAVIS-BOYLE

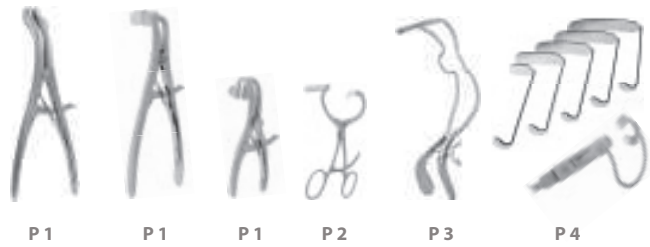

O.R.L. dilateurs - E.N.T. dilators - O.R.L. dilatadores

LABORDE TROUSSEAU ABOULKER

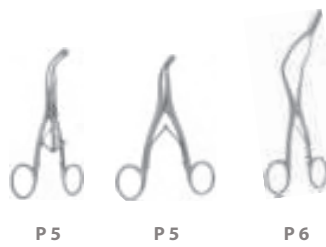

O.R.L. pinces à préhension - E.N.T. grasping forceps - O.R.L. pinzas a prensión

LAHEY BOURGEOIS CHATELIER LUC LUBET BARBON WHITE COLVER

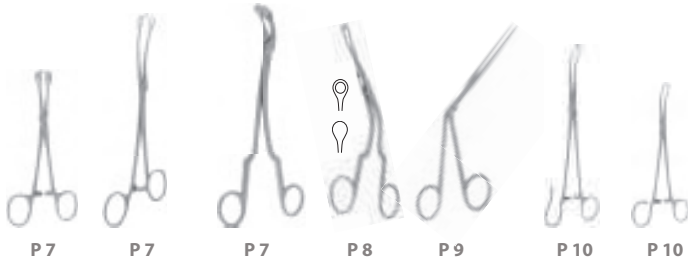

O.R.L. speculums - E.N.T. specula - O.R.L. espéculos

BOWMANN LE MEE DUPLAY VACHER KILLIAN PALMER



O.R.L. Serre-noeud - E.N.T. Snare

O.R.L. Cierra nudos

VACHER

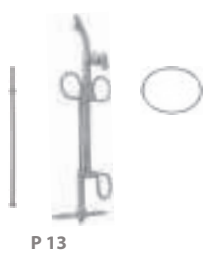

O.R.L. Paracentèse - E.N.T. Paracentesis

O.R.L. Paracentesis



O.R.L. végétations - E.N.T. adenoids - O.R.L. vegetaciones

LERMOYER BECKMANN MOORE



O.R.L. faux spatule - E.N.T. knife spatula

O.R.L. bisturi espátula

KOCHER RUAULT



O.R.L. amygdalotome - E.N.T. tonsillotome

O.R.L. amigdalotomo

SLUDDER-BALLENGER



O.R.L. emporte pièces - E.N.T. punch forceps

O.R.L. sacabocados

KERISSON CITELLI TAKAHASHI HARTMANN



O.R.L. cisaille - E.N.T. shear forceps - O.R.L. cizalla

MOORE



O.R.L. oesophagoscopie - E.N.T. oesophagoscopy - O.R.L. esofagoscopia

CHEVALIER-JACKSON



O.R.L. burins & gouges - E.N.T. chisels & gouges - O.R.L. cinceles & gubias

ROBIN FREER COTTLE HAUTANT LELIEVRE FREER BALLENGER KILLIAN LEBEAU



O.R.L. rugines - E.N.T. raspatories - O.R.L. raspadores

SEBILEAU PENNINGTON



O.R.L. rases - E.N.T. raps - O.R.L. raspas

TAKAHASHI DUFOURMENTEL LIPSETT GALLAHER LEWIS COTTLE AUFRICHT MILLER

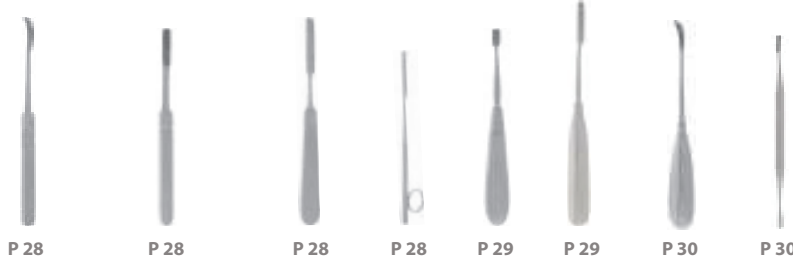

O.R.L. crochets - E.N.T. hooks  
O.R.L. ganchos

FREER FOMON COTTLE FRAZIER

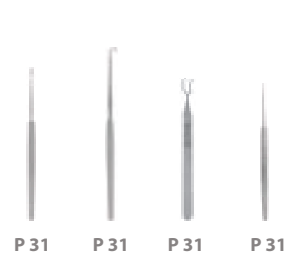

O.R.L. élévateurs - E.N.T. exo-lever  
O.R.L. elevadores

FREER KILLIAN MASING HURD LEMPERT



O.R.L. Joseph - E.N.T. Joseph  
O.R.L. Joseph

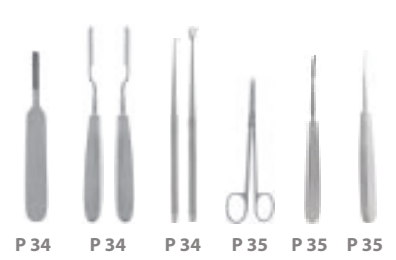

O.R.L. cures - E.N.T. cures - O.R.L. curretas

WILLIGER CLOVIS SNELLEN BILLEAU SEBILEAU  
VINCENT

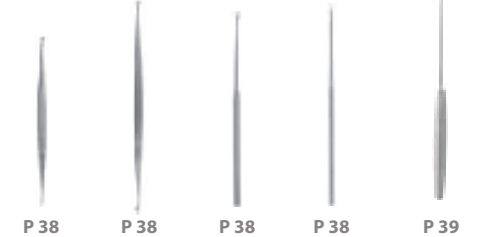

Divers - Miscellaneous - Diversas

CLAOUE AUBRY DAUTREY SEGURA LIMA PLESTER FRAZIER WERTHEIMER



Pinces O.R.L. & Ophtamologie - ENT & Ophtalmologic forceps - Pinzas O.R.L. & Oftalmología

TROELTSCH

POLITZER

LUCAE

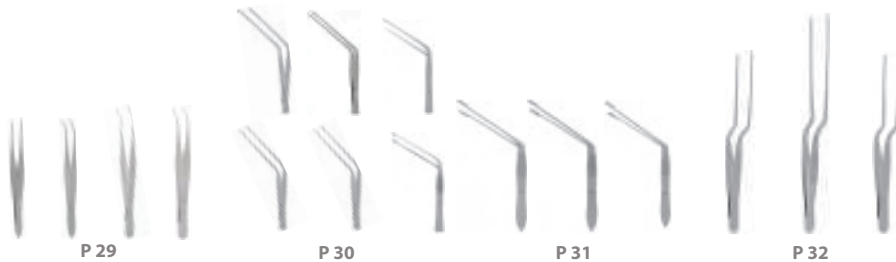

II - Dissection  
II - Dissecting  
II - Disección



# LANDANGER

O.R.L. ouvre-bouche - E.N.T. mouth gag - O.R.L. abre-boca



DELABARRE

TERRIER

ODWYER



**I05010**  
20 cm - 8 "



**I05030**  
20 cm - 8 "



**I05040**  
12 cm - 4 <sup>3</sup>/<sub>4</sub> "

XII - O.R.L.  
XII - E.N.T.  
XII - O.R.L.

# LANDANGER

O.R.L. ouvre-bouche - E.N.T. mouth gag - O.R.L. abre-boca



## DOYEN

Enfants  
Childrens  
Niños

Adultes  
Adults  
Adultos



**I05050**  
11 cm - 4 3/8"

**I05060**  
12 cm - 4 3/4"

**XII - 2**

XII - O.R.L.  
XII - E.N.T.  
XII - O.R.L.

# LANDANGER

O.R.L. ouvre-bouche - E.N.T. mouth gag - O.R.L. abre-boca



## JEANNINGS



- 9 cm - 3 1/2" **I050690**
- 11 cm - 4 1/4" **I05070**
- 13 cm - 5" **I05080**
- 15 cm - 6" **I050810**

**I05070**  
11 cm - 4 3/8"

XII - O.R.L.  
XII - E.N.T.  
XII - O.R.L.

# LANDANGER

O.R.L. ouvre-bouche - E.N.T. mouth gag - O.R.L. abre-boca

3/4

## DAVIS-BOYLE



Protections translucides seules (paire)  
Translucent protection only (pair)  
Protección translúcido sólo (par)

**I051310**

Complet avec 5 valves  
Complete with 5 blades  
Completo con 5 valvulas

**I05130**

**XII - 4**

XII - O.R.L.  
XII - E.N.T.  
XII - O.R.L.

# LANDANGER

O.R.L. dilateurs - E.N.T. dilators - O.R.L. dilatadores



LABORDE

TROUSSEAU



XII - O.R.L.  
XII - E.N.T.  
XII - O.R.L.

# LANDANGER

O.R.L. dilatateurs - E.N.T. dilators - O.R.L. dilatadores



## ABOULKER

Enfants  
Children  
Niños

Adultes  
Adults  
Adultos



8 mm

**I10022**  
18 cm - 7 "



10 mm

**I10024**  
18 cm - 7 "

**XII - 6**

XII - O.R.L.  
XII - E.N.T.  
XII - O.R.L.

# LANDANGER

O.R.L. pinces à préhension - E.N.T. grasping forceps - O.R.L. pinzas a presión

LAHEY

BOURGEOIS

CHATELIER



Anneaux décalés  
Displaced ring  
Anillos decalados

10 mm - 22 cm - 8 <sup>3</sup>/<sub>4</sub> "

I15010

6 mm - 20 cm - 8 "

I15020



I150250  
15 cm - 6 "



I15030  
21 mm - 8 <sup>1</sup>/<sub>4</sub> "



I15010  
22 cm - 8 <sup>3</sup>/<sub>4</sub> "

XII - 7

# LANDANGER

O.R.L. pinces à préhension - E.N.T. grasping forceps - O.R.L. pinzas a presión



## LUC

Mors pleins  
Full jaws  
Bocas llenas

Mors fenêtrés  
Open work jaws  
Bocas perforadas

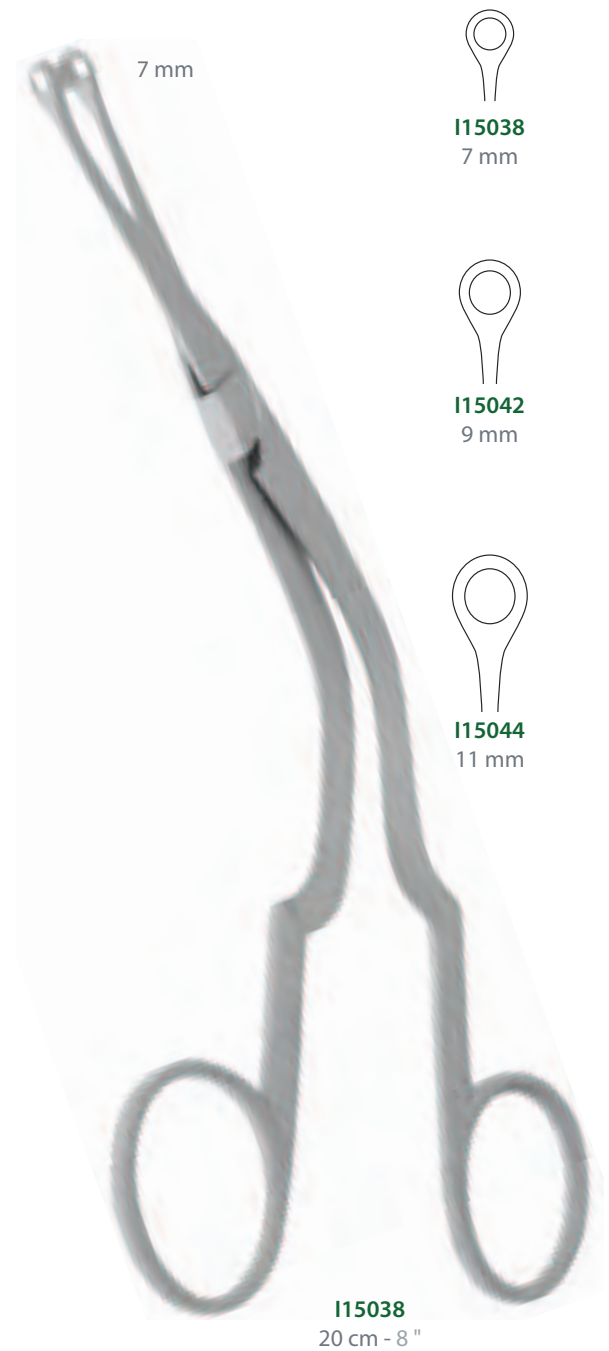

XII - 8

XII - O.R.L.  
XII - E.N.T.  
XII - O.R.L.



# LANDANGER

O.R.L. pincés à préhension - E.N.T. grasping forceps - O.R.L. pinzas a presión



## LUBET BARBON

A griffes    Sans griffes  
With teeth    Without teeth  
Con dientes    Sin dientes

21 cm - 8 1/4"

I15070

I15080



**I15080**  
21 cm - 8 1/4"

XII - O.R.L.  
XII - E.N.T.  
XII - O.R.L.

# LANDANGER

O.R.L. pinces à préhension - E.N.T. grasping forceps - O.R.L. pinzas a presión

3/4

WHITE

COLVER

18 cm - 7"

I150810

23 cm - 9"

I150815



XII - 10

XII - O.R.L.  
XII - E.N.T.  
XII - O.R.L.

# LANDANGER

O.R.L. speculums - E.N.T. specula - O.R.L. espéculos



## BOWMAN (PALMER)



**I151305**

70 mm

## DUPLAY



**I15150**

Adultes  
Adults  
Adultos

Enfants  
Children  
Niños

**I15150**

**I15151**

## LE MEE

L'unité  
Unit  
Unidad

1 mm	<b>I15141-0</b>
2 mm	<b>I15142-0</b>
3 mm	<b>I15145-0</b>
4 mm	<b>I15146-0</b>
5 mm	<b>I15147-0</b>
6 mm	<b>I15148-0</b>



Jeu de 6  
Set of 6  
Juego de 6

**I15140-0**

## VACHER



**I15160**

Adultes  
Adults  
Adultos

Enfants  
Children  
Ninos

**I15160**

**I15170**

# LANDANGER

O.R.L. speculums - E.N.T. specula - O.R.L. espéculos



## KILLIAN

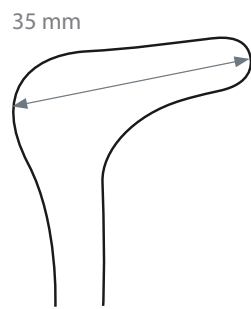

35 mm

**I15175**

14 cm - 5 1/2"

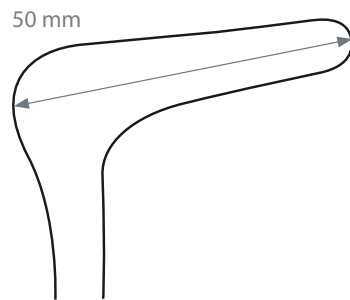

50 mm

**I15180**

15 cm - 6"

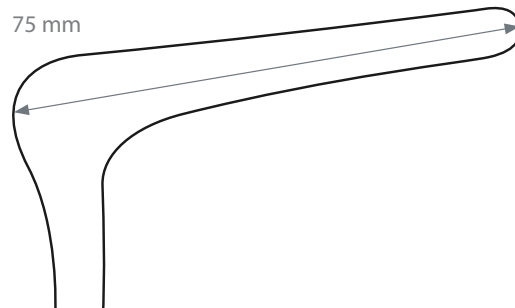

75 mm

**I15185**

16 cm - 6 1/4"



**I15175**

14 cm - 5 1/2"

## VACHER

Cannule seule  
Cannula only  
Canula sóla



**I15200**

Complet avec canule  
Complete with cannula  
Completo con canula



**I15190**

Fil inox  
Stainless wire  
Hilo inoxidable



**I15208**  
Ø 4/10 mm  
2 m

# LANDANGER

O.R.L. aiguilles à paracentèse - E.N.T. paracentesis needles - O.R.L. agujas de paracentesis



I15240

Adultes  
Adults  
Adultos



I15230

Enfants  
Children  
Niños



I15232

Nourrissons  
Babies  
Niños de pecho



I15234

Corps étrangers  
Foreign bodies  
Cuerpos extraños



Droite  
Straight  
Recta

I15250

Coudée  
Angled  
Angulada

I15220

# LANDANGER

O.R.L. couteaux à végétations - E.N.T. adenoids knives - O.R.L. cuchillos para vegetaciones

## LERMOYER

- 10 mm I15340
- 14 mm I15342
- 16 mm I15344
- 20 mm I15346



I15340  
23 cm - 9"

## BECKMANN



- 12 mm I15348
- 14 mm I15350
- 16 mm I15360
- 18 mm I15370



I15348  
21 cm - 8 1/4"

# LANDANGER

O.R.L. couteaux à végétations - E.N.T. adenoids knives - O.R.L. cuchillos para vegetaciones



## MOORE

10 mm	I15400
13 mm	I15410
16 mm	I15420
19 mm	I15430
21 mm	I15440



Sans panier  
Without basket  
Sin cesto

I15400  
21 cm - 8 1/4"

10 mm	I15450
13 mm	I15460
16 mm	I15470
19 mm	I15480
21 mm	I15490



Avec panier  
With basket  
Con cesto

I15450  
21 cm - 8 1/4"



# LANDANGER

O.R.L. faux spatule - E.N.T. knife spatula - O.R.L. bisturí espátula



## KOCHER



**I15330**  
16 cm - 6 1/4"

## RUALT



**I15495**  
22 cm - 8 3/4"



**I15500**  
22 cm - 8 3/4"

Boutonnée  
With tip  
Abotonado

XII - O.R.L.  
XII - E.N.T.  
XII - O.R.L.

# LANDANGER

O.R.L. amygdalotome - E.N.T. tonsillotome - O.R.L. amigdalotomo



## SLUDDER-BALLENGER

Manche seul  
Handle only  
Mango sólo



**I15701**

Lame seule  
Blade only  
Hoja sólo

**I15703**  
N° 1 - 20 mm



**I15704**  
N° 2 - 24 mm



**I15705**  
N° 3 - 27 mm

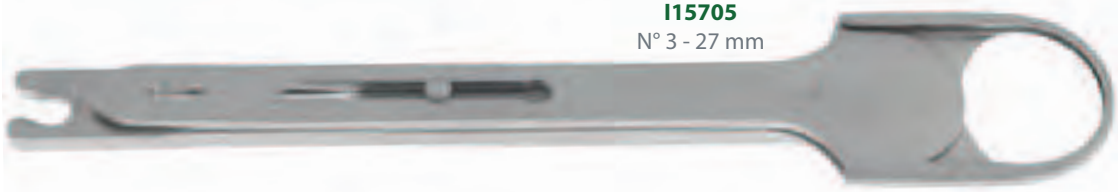

# LANDANGER

O.R.L. emporte pièces - E.N.T. punch forceps - O.R.L. sacabocados



## KERRISSON

- 4 mm **I16010**
- 5 mm **I16015**
- 6 mm **I16020**



4 mm

9 cm - 3 1/2"



**I16010**

## CITELLI

- 3 mm **I16045**



3 mm

8 cm - 3"



**I16045**

XII - O.R.L.  
XII - E.N.T.  
XII - O.R.L.

# LANDANGER

O.R.L. emporte pièces - E.N.T. punch forceps - O.R.L. sacabocados



## TAKAHASHI



## HARTMANN

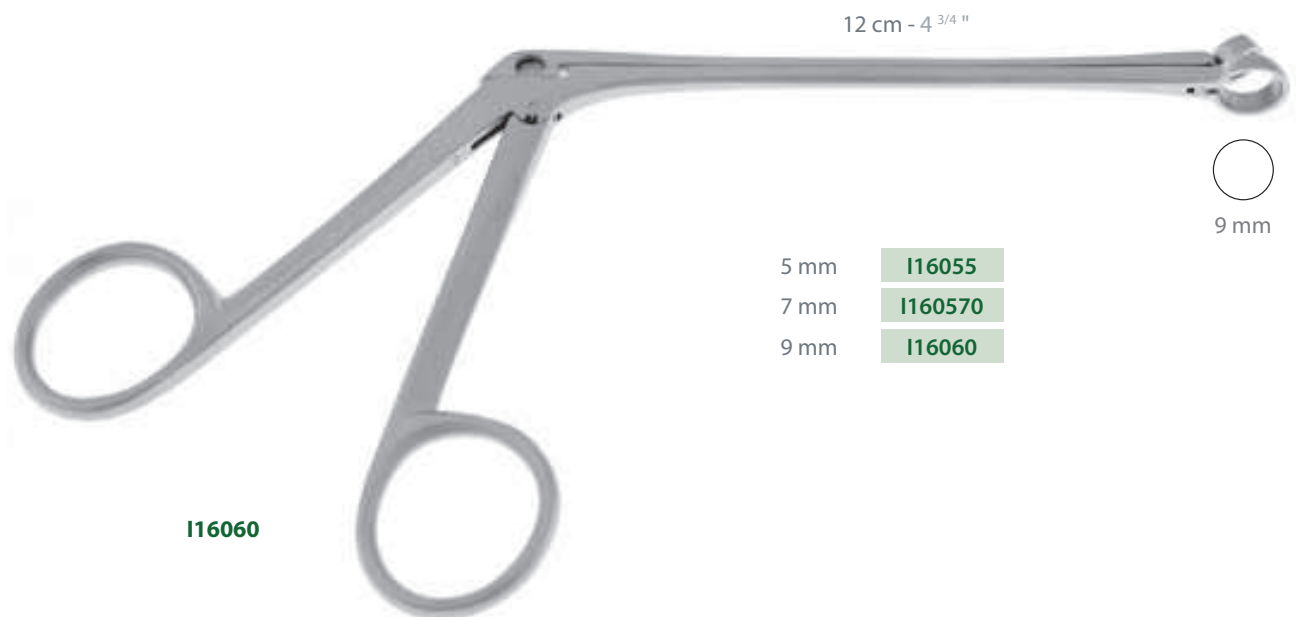

# LANDANGER

O.R.L. emporte pièces - E.N.T. punch forceps - O.R.L. sacabocados



## JANSEN



5 mm

**I16035**

19 cm - 7 1/2 "

XII - O.R.L.  
XII - E.N.T.  
XII - O.R.L.

**XII - 21**

# LANDANGER

O.R.L. cisaille - E.N.T. shear forceps - O.R.L. cizalla



MOORE



**116040**  
20 cm - 8 "

**XII - 22**

XII - O.R.L.  
XII - E.N.T.  
XII - O.R.L.

# LANDANGER

O.R.L. pinces pour oesophagoscopie - E.N.T. forceps for oesophagoscopy - O.R.L. pinzas para esofagoscopia



## CHEVALIER-JACKSON

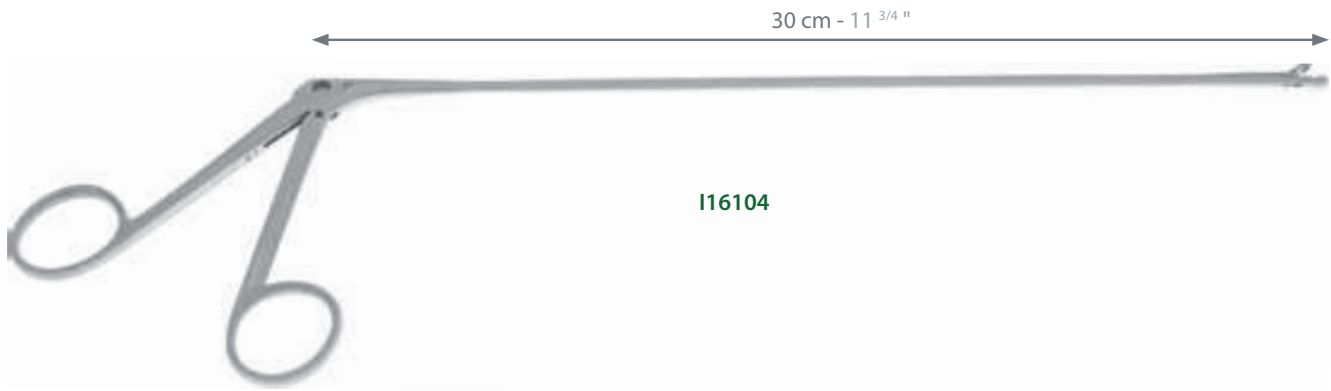

30 cm - 11 <sup>3</sup>/<sub>4</sub> "

I16100



50 cm - 19 <sup>3</sup>/<sub>4</sub> "

I16102

I16104



I16106

I16108



I16110

I16112



I16114

# LANDANGER

O.R.L. burins & gouges - E.N.T. chisels & gouges - O.R.L. cinceles & gubias

1/1

ROBIN

FREER

COTTLE

- 4 mm I170010
- 7 mm I170011
- 9 mm I170012
- 12 mm I170013

8 x 12 mm

4 mm

7 mm

Ostéotome  
Osteotome  
Osteotomo



I17001  
16 cm - 6 1/4 "

I170005  
16 cm - 6 1/4 "

I170011  
18 cm - 7 "

XII - 24

XII - O.R.L.  
XII - E.N.T.  
XII - O.R.L.



# LANDANGER

O.R.L. burins & gouges - E.N.T. chisels & gouges - O.R.L. cinceles & gubias

## HAUTANT

Burin  
Chisel  
Cinceles

Gouge  
Gouge  
Gubias

2 mm	I17005
3 mm	I17010
4 mm	I17015
5 mm	I17020
6 mm	I17025
7 mm	I17030
8 mm	I17035
10 mm	I17040
12 mm	I17045

2 mm	I17050
3 mm	I17055
4 mm	I17060
5 mm	I17065
6 mm	I17070
7 mm	I17075
8 mm	I17080
10 mm	I17085
12 mm	I17090

## LELIEVRE



Burin fin  
Fine chisel  
Cinceles fino

4 mm	I170460
6 mm	I170461



**I17025**  
13 cm - 5 "



**I17055**  
13 cm - 5 "



**I170461**  
21 cm - 8 1/4 "

# LANDANGER

O.R.L. gouges - E.N.T. gouges - O.R.L. gubias



## BALLENGER

## LEBEAU

### FREER

4 mm	I170924
6 mm	I170926
8 mm	I170928

3 mm	I170940
4 mm	I170941
7 mm	I170942

### KILLIAN

Droite  
Straight  
Recta

En V  
V form  
Forma V

6 mm



I170920  
15 cm - 6 "

8 mm



I170928  
16 cm - 6 1/4 "



I170940  
20 cm - 8 "

7 mm



I17108  
15 cm - 6 "

7 mm



I17110  
15 cm - 6 "

# LANDANGER

O.R.L. rugines - E.N.T. raspatories - O.R.L. raspadores

## SEBILEAU

## PENNINGTON



Droite  
Straight  
Recta

4 mm



**I17100**  
15 cm - 6 "

1/2 courbe  
1/2 curved  
Media curva

4 mm



**I17102**  
15 cm - 6 "

Courbe  
Curved  
Curva

4 mm



**I17104**  
15 cm - 6 "



**I171060**  
21 cm - 8 1/4"

XII - O.R.L.  
XII - E.N.T.  
XII - O.R.L.

# LANDANGER

O.R.L. rapes - E.N.T. raps - O.R.L. raspas



## TAKAHASHI

Convexe  
Convex  
Convexa

7 mm



**I17112**  
19 cm - 7 1/2"

## DUFOURMENTEL

Concave  
Concave  
Concava

7,5 mm



**I17116**  
18 cm - 7 "

## LIPSETT

Rainurée  
Grooved  
Ranurada

8 mm



**I17124**  
19 cm - 7 1/2"

## GALLAHER

Droite  
Straight  
Recta



**I17118**  
16 cm - 6 1/4"

XII - O.R.L.  
XII - E.N.T.  
XII - O.R.L.

# LANDANGER

O.R.L. raps - E.N.T. raps - O.R.L. raspas

## LEWIS

## COTTLE



Denture large  
Wide teeth  
Dientes amplios

Denture fine  
Fine teeth  
Dientes finas



**I171265**  
18 cm - 7 "



**I171260**  
18 cm - 7 "



**I171270**  
21 cm - 8 1/4 "

XII - O.R.L.  
XII - E.N.T.  
XII - O.R.L.



## AUFRICHT

## MILLER



Taille vers l'avant  
Upwards stroke  
Movimiento adelante



I171274  
21 cm - 8 1/4"

Taille vers l'arrière  
Downwards stroke  
Movimiento hacia la trasera

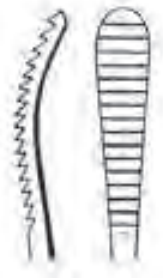

I171275  
21 cm - 8 1/4"



I171280  
16 cm - 7"

I171275  
21 cm - 8 1/4"

# LANDANGER

O.R.L. crochet élévateur - E.N.T. hook exo-lever - O.R.L. gancho elevador



**FREER**

**FOMON**

**COTTLE**

**FRAZIER**

Pointu / Pointu	<b>I171310</b>
Boutonné / Pointu	<b>I171311</b>
Pointu / Boutonné	<b>I171312</b>

Crochet double  
Double hook  
Doble gancho



**I171305**  
15 cm - 6 "



**I171308**  
17 cm - 6 <sup>3</sup>/<sub>4</sub> "

Crochet double  
Double hook  
Doble gancho

9 x 4 mm



**I171310**  
14 cm - 5 <sup>1</sup>/<sub>2</sub> "



**I171311**



**I171312**



**I17135**  
13,5 cm - 5 <sup>1</sup>/<sub>4</sub> "

XII - O.R.L.  
XII - E.N.T.  
XII - O.R.L.

# LANDANGER

O.R.L. éleveurs - E.N.T. exo-lever - O.R.L. elevador



## FREER

Tranchant  
Sharp  
Cortante

5 mm



**I171360**  
18,5 cm - 7 1/4 "

## KILLIAN



**I171365**  
18,5 cm - 7 1/4 "

## MASING



**I171370**  
20,5 cm - 8 "

**XII - 32**

XII - O.R.L.  
XII - E.N.T.  
XII - O.R.L.



# LANDANGER

O.R.L. éleveurs - E.N.T. exo-lever - O.R.L. elevador

## HURD



**I171390**  
22,5 cm - 8 <sup>3</sup>/<sub>4</sub> "

## LEMPERT



18 cm - 7 " **I171380**

20,5 cm - 7 <sup>3</sup>/<sub>4</sub> " **I171381**



Courbe  
Curved  
Curvo

**I171380**  
18 cm - 7 "



Légèrement courbe  
Lightly curved  
Ligeramente curvo

**I171381**  
20,5 cm - 8 "

XII - O.R.L.  
XII - E.N.T.  
XII - O.R.L.

# LANDANGER

Instrumentation de Joseph - Joseph's instrumentation - Instrumentación de Joseph



## JOSEPH

	<b>I171290</b>
3 mm	<b>I171292</b>
5 mm	<b>I171295</b>
7 mm	<b>I171297</b>
10 mm	<b>I171300</b>

Rape  
Rasp  
Raspa

7mm



**I17114**

17 cm - 6 <sup>3</sup>/<sub>4</sub> "

Scie  
Saw  
Sierra

Droite  
Right  
Recta

Gauche  
Left  
Izquierda



**I17150**

19,5 cm - 7 <sup>3</sup>/<sub>4</sub> "



**I17155**

19,5 cm - 7 <sup>3</sup>/<sub>4</sub> "

Crochet nasal  
Nasal hook  
Gancho nasal



3 mm



5 mm



7 mm



10 mm

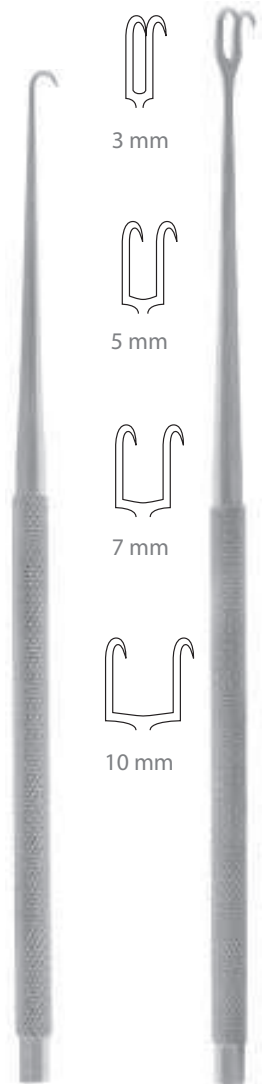

**I171290**

15 cm - 6 "



**I171292**

16 cm - 6 <sup>1</sup>/<sub>4</sub> "

**XII - 34**

XII - O.R.L.  
XII - E.N.T.  
XII - O.R.L.

# LANDANGER

Instrumentation de Joseph - Joseph's instrumentation - Instrumentación de Joseph



## JOSEPH

Ciseaux  
Scissors  
Tijeras

Élévateur  
Elevator  
Elevador

Rugine  
Raspatory  
Raspador

Droit  
Straight  
Recta

Courbe  
Curved  
Curva

Droite  
Straight  
Recta

Courbe  
Curved  
Curva

14 cm - 5 1/2"

I19010

I19020

17 cm - 6 3/4"

I19040

I19050



**I19010**  
14 cm - 5 1/2"



**I19030**  
16,5 cm - 6 1/2"



**I19050**  
17 cm - 6 3/4"

XII - O.R.L.  
XII - E.N.T.  
XII - O.R.L.

# LANDANGER

O.R.L. écarteurs - E.N.T. retractors - O.R.L. separadores



## CLAOUE

## AUBRY (en Z)

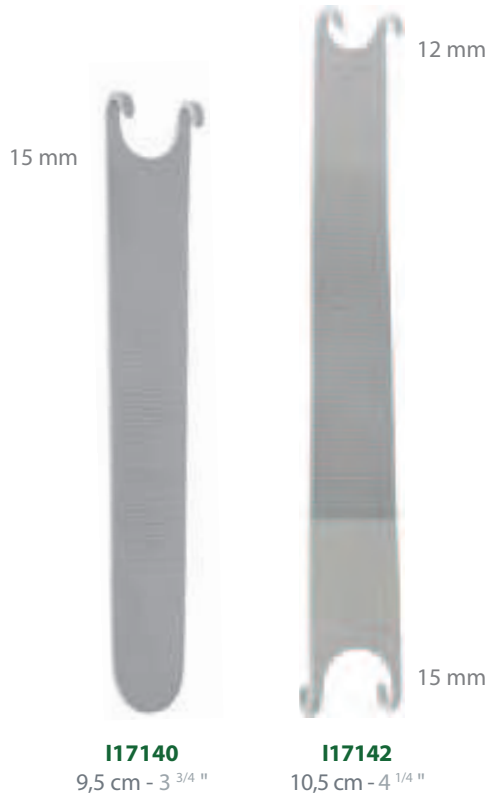

## DAUTREY



# LANDANGER

O.R.L. maillets - E.N.T. mallets - O.R.L. mazos

## SEGURA

110 g **I17160**  
150 g **I17162**



**I17160**  
20 cm - 8"



**I17162**  
20 cm - 8"

## LIMA



3 mm **I18005**  
5 mm **I18010**  
7 mm **I18020**



**I18005**  
26 cm - 10 1/4"

XII - O.R.L.  
XII - E.N.T.  
XII - O.R.L.

# LANDANGER

O.R.L. cures - E.N.T. cures - O.R.L. cures



## WILLIGER

Double ronde  
Double round  
Doble ronda

2 mm **I180022**  
3 mm **I180023**

## CLOVIS VINCENT

Malléable  
Malleable  
Maleable

3 x 4 mm **I180030**  
5 x 6 mm **I180031**  
7 x 8 mm **I180032**  
9 x 10 mm **I180033**

Rigide  
Rigid  
Rigida

3 x 4 mm **I180035**  
5 x 6 mm **I180036**  
7 x 8 mm **I180037**  
9 x 10 mm **I180038**

## SNELLEN

N° 1 **I180380**  
N° 2 **I180381**

## BILLEAU

N° 1 **I180385**  
N° 2 **I180386**  
N° 3 **I180387**

2 mm



2 mm

**I180022**  
14 cm - 5 1/2"

3 mm



4 mm

**I180035**  
20 cm - 8"



N° 1



N° 2



N° 1



N° 2



N° 3

**I180381**  
16 cm - 6 1/4"

**I180385**  
16,5 cm - 6 1/2"

**XII - 38**

XII - O.R.L.  
XII - E.N.T.  
XII - O.R.L.

## SEBILEAU



Droite  
Straight  
Recta



1/2 Courbe  
Half curved  
Media curva



Courbe  
Curved  
Curva

Pleine  
Full  
Llena

Ø 4 mm

**I18021**

**I18024**

**I18027**

Ø 5 mm

**I18022**

**I18025**

**I18028**

Fenêtrée  
Open work  
Conventana

Ø 4 mm

**I18030**

**I18033**

**I18036**

Ø 5 mm

**I18031**

**I18034**

**I18037**

**I18021**  
26 cm - 10 1/4"

# LANDANGER

O.R.L. canules aspiratrices - E.N.T. suction tubes - O.R.L. canulas aspirantes



## PLESTER

∅	
1,5 mm	<b>I182015</b>
2,0 mm	<b>I182020</b>
2,5 mm	<b>I182025</b>
3,0 mm	<b>I182030</b>

## FRAZIER

∅	
2,0 mm	<b>I18040-0</b>
2,5 mm	<b>I18042-0</b>
3,3 mm	<b>I18044-0</b>
4,0 mm	<b>I18046-0</b>

## WERTHEIMER

∅	
2,0 mm	<b>I180502</b>
3,0 mm	<b>I180503</b>
4,0 mm	<b>I180504</b>
5,0 mm	<b>I180515</b>



**I182025**  
19,5 cm - 7 3/4"



**I18040-0**  
22 cm - 8 3/4"



**I180502**  
16 cm - 6 1/4"

**XII - 40**

XII - O.R.L.  
XII - E.N.T.  
XII - O.R.L.



Tendons - Tendons - Tendones

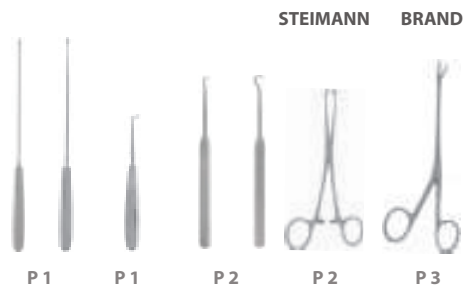

Amputation - Amputation - Amputación

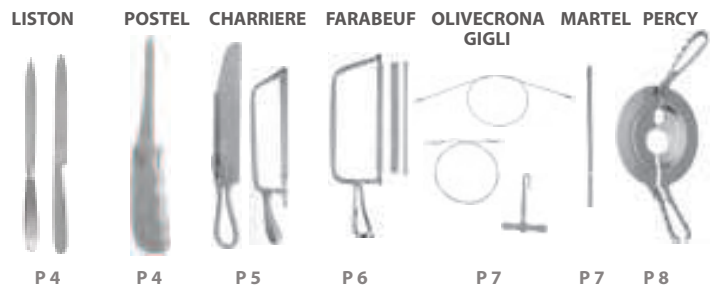

Instrumentation osseuse rugines - Osseous instrumentation raspatories - Instrumentación oseo raspadores

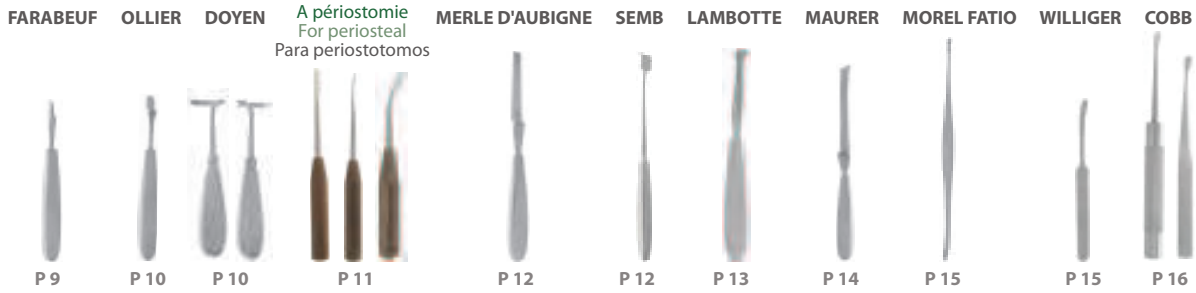

Dissecteurs - Dissectors - Disectores

LERICHE



Râpes - Rasps - Raspas



Instrumentation osseuse curettes - Osseous instrumentation curettes - Instrumentación oseo curetas

VOLKMANN BRUNS CHARNLEY LETOURNEL BESNIER VIDAL BROCK UNNA WILLIGER



Instrumentation osseuse ciseaux burins - Osseous instrumentation bone chisels - Instrumentación oseo cinceles

POIRIER LUCAS FARABEUF STILLE OMBREDANNE MAC EVEN PAUWELLS LAMBOTTE DUPONT CAUCHOIX STILLE LEXER  
CHAMPIONNIERE

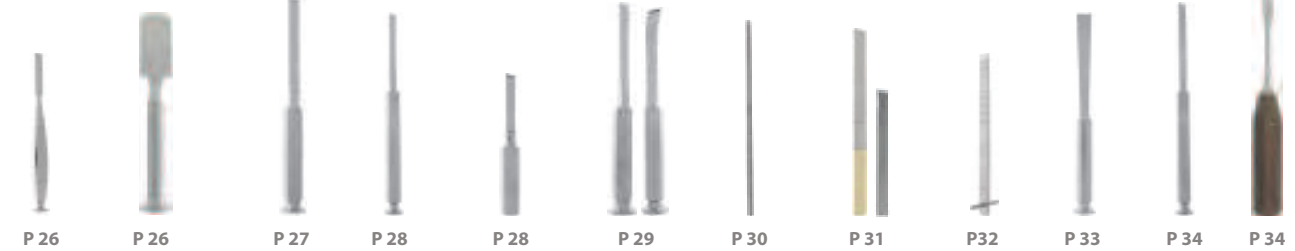

Instrumentation osseuse gouges - Osseous instrumentation gouges - Instrumentación oseó gubias

**GUILLAUME NANCY POIRIER STILLE SMITH-PETERSEN CAUCHOIX FARABEU STAGNARA COBB**



**Maillets - Mallets - Mazos**

**OMBREDANE MAC EVEN JUDET**



**Poinçons - Punch - Punzones**

**ISSELIN OMBREDANE MERLE D'AUBIGNE ROCHER FICAT**



**Crochets - Hooks - Ganchos**

**KOENING LAMBOTTE**



**Mesureurs - Measures - Medidores**



**Pinces gouges - Bone rongeur forceps - Pinzas gubias**

**LEMPERT LOMBARD STILLE ECHLIN SAUERBRUCH DAVID VINCENT SICARD BOEHLER BEYER**



**LUER-FRIEDMANN MINI-FRIEDMANN SMITH-PETERSEN LEKSELL-STILLE BEYER-ZAUFAL MARQUARDT LUER BLUMENTHAL MEAD**

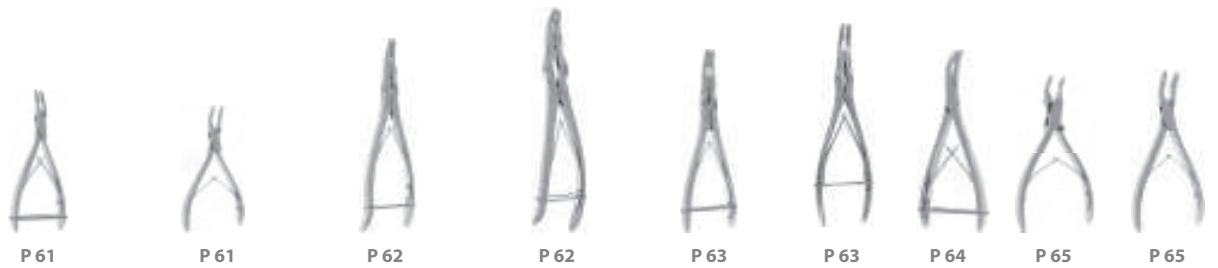

Pincas coupantes - Bone cutting forceps - Pinzas cortantes

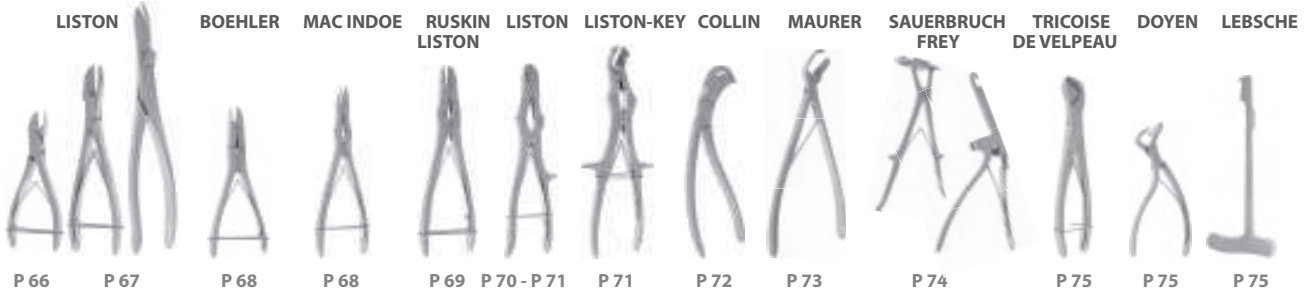

Daviers - Bone holding forceps - Pinzas para huesos

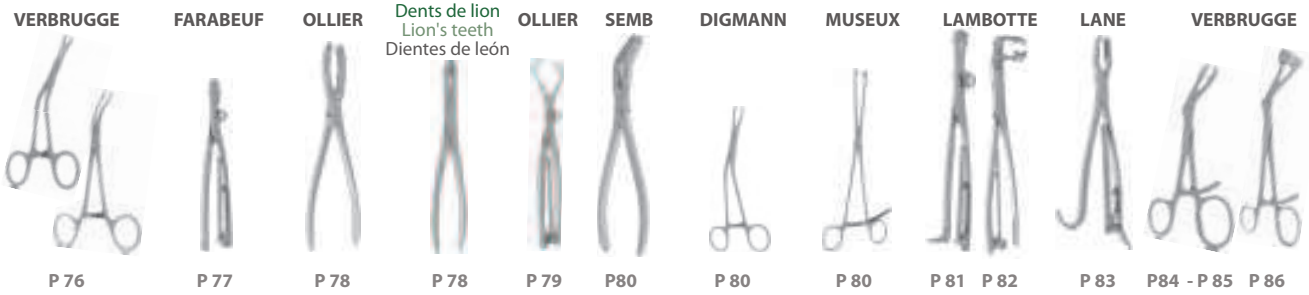

Auto-centreur  
Auto-centering  
Auto-centrador

Réducteur - Préhenseur  
Reducing - Prehensile  
Reductor - Prensador

LANDANGER

Divers - Miscellaneous - Diversas

A décapsuler  
To take capsules off  
Para decapsular

LOWMAN  
HOGLUND

LOUTE

DANIS



Écarteur - Main de plomb - Retractors - Lead hands  
Separadores - Mano de plomo

CHARNLEY

Chasse-greffon - Graft remover  
Expulsa injerto

Bankart - Bankart - Bankart

MERLE D'AUBIGNE

POZZI



Danis - Danis - Danis

Étrier - Wire traction bow - Estribos

KIRSCHNER

KIRSCHNER

Américain  
American  
Americano

BOEHLER

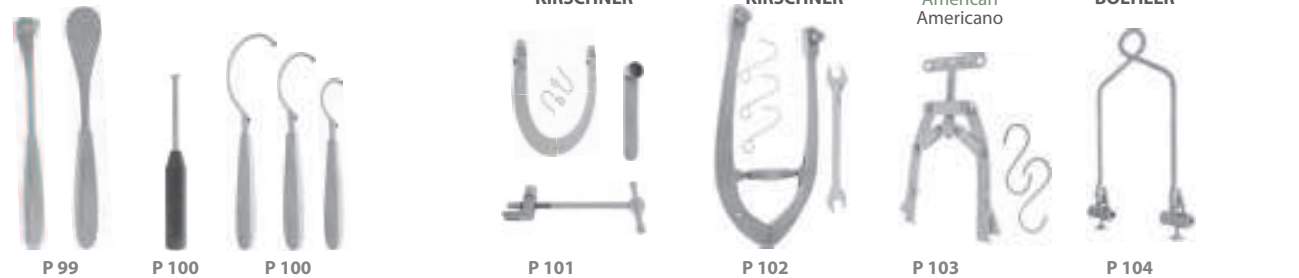

Instruments à ménisque - Meniscus instruments - Instrumentación para menisco

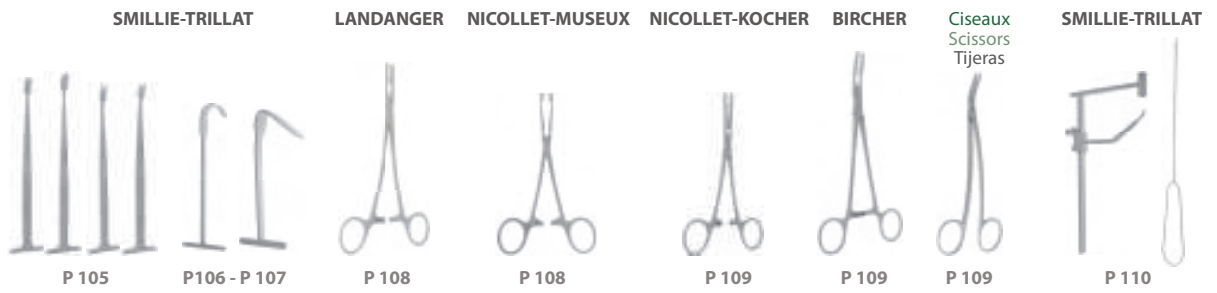

Trillat - Trillat - Trillat

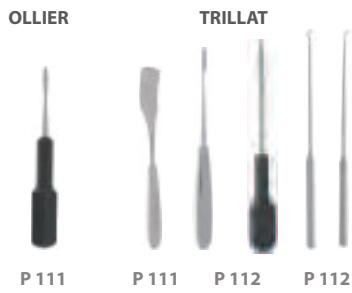

Instrumentation pour genou - Instrumentation for knee - Instrumentación para rodilla



Écarteurs osseux - Osseous Retractors - Separadores oseos

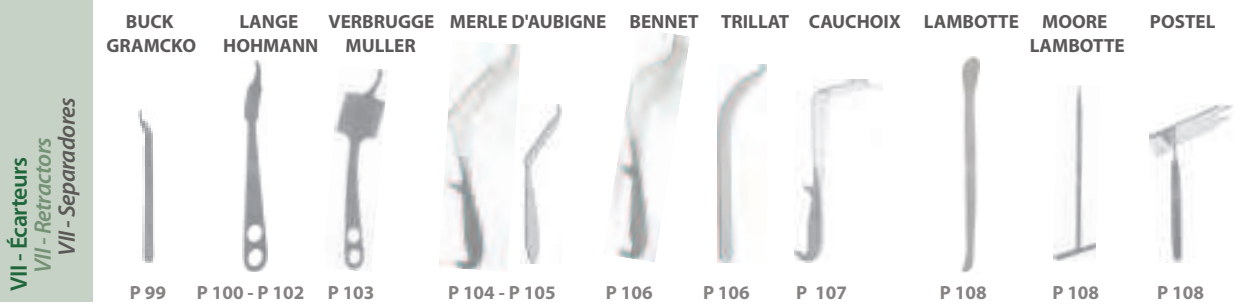

VII - Écarteurs  
VII - Retractors  
VII - Separadores

O.R.L. burins & gouges - E.N.T. chisels & gouges - O.R.L. cinceles & gubias

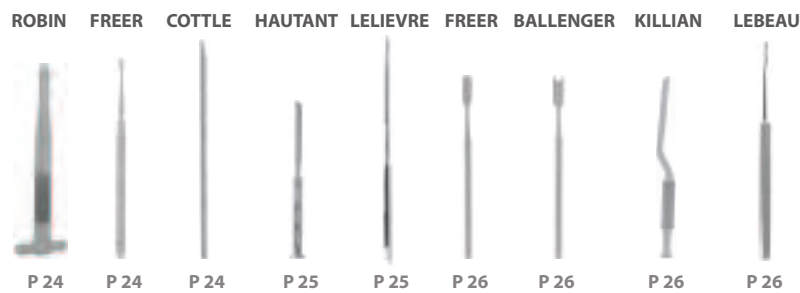

XII - O.R.L.  
XII - E.N.T.  
XII - O.R.L.

O.R.L. rapes - E.N.T. raps - O.R.L. raspas

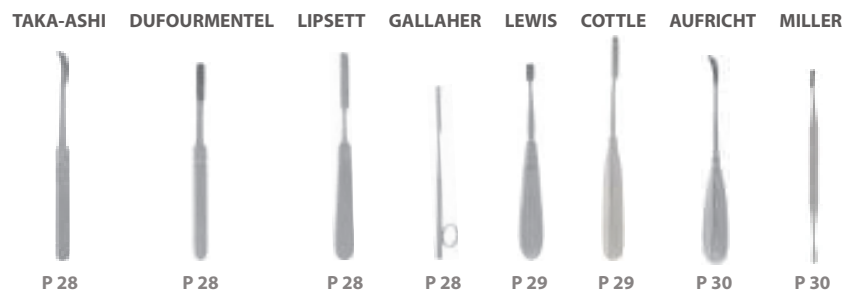

XII - O.R.L.  
XII - E.N.T.  
XII - O.R.L.

# LANDANGER

## Chirurgie des tendons - Surgery for tendons - Cirugía para tendones



Passe fil  
Wire guide  
Guia - hilo



**J04010**  
28 cm - 11 "

Décolleur  
Detacher  
Disector



**J04040**  
28 cm - 11 "

Rugine  
Raspatory  
Raspador



**J04050**  
18 cm - 7 "

# LANDANGER

Chirurgie des tendons - Surgery for tendons - Cirugía para tendones

1/1

## STEIMANN

Crochet  
Hook  
Ganchura

6 mm



**J04060**  
17 cm - 6 3/4 "

9 mm



**J04070**  
17 cm - 6 3/4 "

Pince à tendons  
Tendon's forceps  
Pinza para tendones



**J04090**  
16 cm - 6 1/4 "

**XIII - 2**

XIII - Osseux  
XIII - Bones surgery  
XIII - Cirugía osea

# LANDANGER

Chirurgie des tendons - Surgery for tendons - Cirugía para tendones



## BRAND

Droite  
Straight  
Recta

15 cm - 5 <sup>3</sup>/<sub>4</sub>"

J041000

19 cm - 7 <sup>1</sup>/<sub>2</sub>"

J041010

24 cm - 9 <sup>1</sup>/<sub>2</sub>"

J041020

Courbe  
Curved  
Curva

15 cm - 5 <sup>3</sup>/<sub>4</sub>"

J041030

19 cm - 7 <sup>1</sup>/<sub>2</sub>"

J041040

24 cm - 9 <sup>1</sup>/<sub>2</sub>"

J041050



**J041010**

19 cm - 7 <sup>1</sup>/<sub>2</sub>"

Pince à tendons  
Tendon's forceps  
Pinza para tendones



**J041050**

24 cm - 9 <sup>1</sup>/<sub>2</sub>"

# LANDANGER

Instrument pour amputation - Instruments for amputation - Instrumentos para amputación



## LISTON

Lame  
Blade  
Hoja

16 cm - 6 1/4 "

**J120650**

19 cm - 7 1/2 "

**J120651**

22 cm - 8 3/4 "

**J120652**



**J120651**  
19 cm - 7 1/2 "

Lame  
Blade  
Hoja

15 cm - 6 "

**J12030**

20 cm - 8 "

**J12060**



**J12060**  
20 cm - 8 "

## POSTEL

Scie à main  
Hand saw  
Sierra a mano

Lame seule  
Blade only  
Hoja sólo



**J120700**  
23,5 cm - 9 1/4 "



**J120710**  
14,5 cm - 5 3/4 "

**XIII - 4**



# LANDANGER

Instrument pour amputation - Instruments for amputation - Instrumentos para amputación

## CHARRIERE



27cm - 10 1/2 "

**J120827**

30 cm - 11 3/4 "

**J120830**

Complète avec 2 lames 12 mm et 15 mm  
Complete with 2 blades 12 mm and 15 mm  
Completa con 2 hojas 12 mm y 15 mm



Lame seule  
Blade only  
Hoja sólo

**J120828**

27 cm - 10 1/2 "

**J120831**

30 cm - 11 3/4 "

**J120827**  
27 cm - 10 3/4 "



Lame seule  
Blade only  
Hoja sólo

**J121612**

12 mm  
22,3 cm - 8 3/4 "

**J121615**

15 mm  
22,3 cm - 8 3/4 "

**J121610**  
35 cm - 13 3/4 "

# LANDANGER

Instrument pour amputation - Instruments for amputation - Instrumentos para amputación



## FARABEUF

Complète avec 3 lames (8 - 16 - 20 mm)  
Complete with 3 blades (8 - 16 - 20 mm)  
Completa con 3 hojas (8 - 16 - 20 mm)



Lame seule  
Blade only  
Hoja sólo

8 mm	<b>J12190</b>
16 mm	<b>J12220</b>
20 mm	<b>J12225</b>

**J12180**  
37 cm - 14 1/2"

**XIII - 6**

# LANDANGER

Instrumentation pour amputation - Instruments for amputation - Instrumentos para amputación



## GIGLI



**J12250**  
45 cm - 17 <sup>3</sup>/<sub>4</sub> "

## MARTEL

Conducteur à crochet simple  
Conductor with simple hook  
Conductor con ganchura simple



**J12285**  
35 cm - 13 <sup>3</sup>/<sub>4</sub> "

## OLIVECRONA



**J12260**  
40 cm - 15 <sup>3</sup>/<sub>4</sub> "

Poignée pour scie  
Handle for saw  
Puñado para sierra



**J12240**

XIII - Osseux  
XIII - Bone surgery  
XIII - Cirugía ósea

**XIII - 7**

# LANDANGER

Instrumentation pour amputation - Instruments for amputation - Instrumentos para amputación

3/4

PERCY



J12270



Couteau à cerveau  
Brain knife  
Cuchillo para cerebro

J14140  
31 cm - 12 1/4"



Ciseaux enterotome  
Scissors enterotome  
Tijeras enterotomo

J14145  
21 cm - 8 1/4"

XIII - 8

XIII - Osseux  
XIII - Bones surgery  
XIII - Cirugía osea

# LANDANGER

Instrumentation osseuse rugines - Osseous instrumentation raspatories - Instrumentación osea raspadores



## FARABEUF

Largeur Width Anchura	Droite Straight Recta
3 mm	J24010
4 mm	J24020
6 mm	J24030
8 mm	J24040
10 mm	J24050
12 mm	J24060
14 mm	J24070

Largeur Width Anchura	Courbe Curved Curva
3 mm	J24078
4 mm	J24080
6 mm	J24090
8 mm	J24100
10 mm	J24110
12 mm	J24120
14 mm	J24130



**J24010**  
16 cm - 6 1/4 "



**J24078**  
16 cm - 6 1/4 "

**XIII - 9**

# LANDANGER

Instrumentation osseuse rugines - Osseous instrumentation raspatories - Instrumentación osea raspadores



## OLLIER

## DOYEN

Droite  
Straight  
Recta

Convexe  
Convex  
Convexa

Concave  
Concave  
Concava

Gauche  
Left  
Izquierdao

Droite  
Right  
Derecho

**J24140**  
10 mm



**J24150**  
10 mm



**J24160**  
10 mm



16 cm - 6 1/4 "

**J24170**  
16 cm - 6 1/4 "

**J24180**  
16 cm - 6 1/4 "

**J241810**  
24 cm - 9 1/2 "

**J241811**  
24 cm - 9 1/2 "

**XIII - 10**

# LANDANGER

Instrumentation osseuse rugines - Osseous instrumentation raspatories - Instrumentación osea raspadores



A PÉRIOSTOMIE - MANCHE CELERON  
 FOR PERIOSTEAL - CELERON HANDLE  
 PARA PERIOSTOTOMOS - MANGO CELERON



**J241901**  
 6 mm  
 19 cm - 7 1/2 "

**J241902**  
 3 mm  
 18,5 cm - 7 1/4 "

**J241903**  
 6 mm  
 18,5 cm - 7 1/4 "

**J241904**  
 6 mm  
 18,5 cm - 7 1/4 "

**J241907**  
 14 mm  
 18,5 cm - 7 1/4 "

**J241905**  
 13 mm  
 18,5 cm - 7 1/4 "

**J241906**  
 14 mm  
 19,5 cm - 7 3/4 "

**J241908**  
 20 mm  
 18,5 cm - 7 3/4 "

XIII - Osseux  
 XIII - Bone surgery  
 XIII - Cirugía osea

# LANDANGER

Instrumentation osseuse rugines - Osseous instrumentation raspatories - Instrumentación osea raspadores



## MERLE D'AUBIGNE

## SEMB



Droite  
Straight  
Recta

Courbe  
Curve  
Curva

10 mm

J24192

J24194

12 mm

J24193

J24195

Pour les arêtes  
For edges  
Para los bordes



**J24200**  
12 mm

Pour les faces  
For faces  
Para los caras



**J24215**  
12 mm



**J24192**  
23 cm - 9"

**J24200**  
23 cm - 9"

**XIII - 12**



## LAMBOTTE



6 mm	J24219
10 mm	J24220
12 mm	J24230
15 mm	J24240
18 mm	J24250
20 mm	J24260
25 mm	J24270

**J24240**  
21 cm - 8 1/4 "

# LANDANGER

Instrumentation osseuse rugines - Osseous instrumentation raspatories - Instrumentación osea raspadores

1/1

## MAURER



3/4

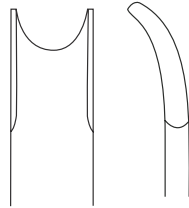

En fourche  
Forked  
Forma de horca

-  
J24280

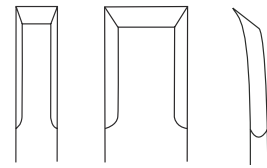

Droite  
Straight  
Recta

6 mm  
J24282  
12 mm  
J24284

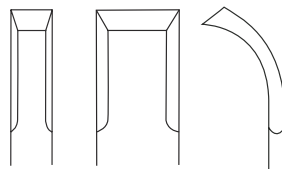

1/2 courbe  
Half curved  
Medio curva

J24310  
J24320

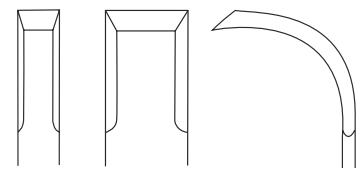

Courbe  
Curved  
Curva

6 mm  
J24290  
12 mm  
J24300

J24280  
26 cm - 10 1/4 "

# LANDANGER

Instrumentation osseuse rugines - Osseous instrumentation raspatories - Instrumentación osea raspadores



## MOREL FATIO

## WILLIGER

Pour ligament jaune  
For yellow ligament  
Para ligamento amarillo



**J24371**  
20 cm - 8 "



**J24372**  
22 cm - 8 3/4 "



**J24373**  
16 cm - 6 1/4 "

# LANDANGER

Instrumentation osseuse rugines - Osseous instrumentation raspatories - Instrumentación osea raspadores

3/4

## COBB



9 mm



13 mm



19 mm

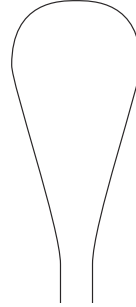

J24374

9 mm

J243775

J24376

13 mm

J243776

J243770

19 mm

J243777

Manche antidérapant  
Handle non slip-coating  
Mango antiderrapante



J24374

30 cm - 11 3/4 "

J243775

25 cm - 10 "

XIII - 16

# LANDANGER

Instrumentation osseuse dissecteurs - Osseous instrumentation dissectors - Instrumentación osea disectores

## LERICHE



Largeur  
Width  
Anchura

Longueur - Length - Largo

	16 cm - 6 1/4 "	20 cm - 8 "	25 cm - 10 "
3 mm	J24378	-	-
4 mm	J24380	J24400	-
5 mm	J24390	J24405	J24415
6 mm	-	J24410	J24420
7 mm	-	-	J24425

**J24405**  
20 cm - 8 "

# LANDANGER

Instrumentation osseuse râpes - Osseous instrumentation rasps - Instrumentación osea raspas

3/4



**J244650**  
25 cm - 10 "



**J24470**  
23 cm - 9 "

**XIII - 18**













**XIII - Osseux**  
XIII - Bones surgery  
XIII - Cirugía osea

# LANDANGER

Instrumentation osseuse curettes - Osseous instrumentation curettes - Instrumentación osea curetas

## VOLKMANN



	∅	16 cm - 6 1/4 "	20 cm - 8 "
	1 mm	J28005	J281507
	2 mm	J28010	J281508
	3 mm	J28020	J281509
	4 mm	J28030	J28151
	5 mm	J28040	J281515
	6 mm	J28050	J28152
	7 mm	J28060	J281525
	8 mm	J28070	J28153
	9 mm	J28080	J281535
	10 mm	J28090	J28155
	12 mm	J28110	J28156
	14 mm	J28130	J28157
	16 mm	J28150	J28158







**J28060**  
16 cm - 6 1/4 "

# LANDANGER

Instrumentation osseuse currettes - Osseous instrumentation currettes - Instrumentación osea curretas

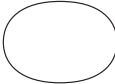
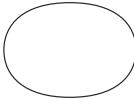
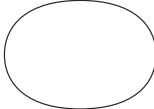
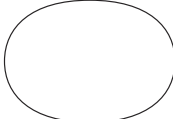
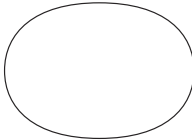
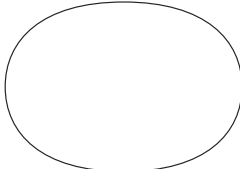
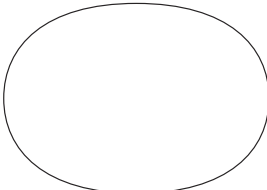

## VOLKMANN

	Ø	24 cm - 9 1/2 "	28 cm - 11 "
	4 mm	J281620	J282310
	6 mm	J28163	J28232
	8 mm	J28170	J28234
	10 mm	J28180	J28236
	12 mm	J28190	J28240
	14 mm	J28200	J28250
	16 mm	J28210	J28260
	18 mm	J28220	J28270
	20 mm	J28230	J28280
	25 mm	-	J28290
	28 mm	-	J28300



**J28210**  
24 cm - 9 1/2 "

**XIII - 20**



## BRUNS

Ronde - Round - Redonda



**J283100**  
17 cm - 6 <sup>3</sup>/<sub>4</sub> "

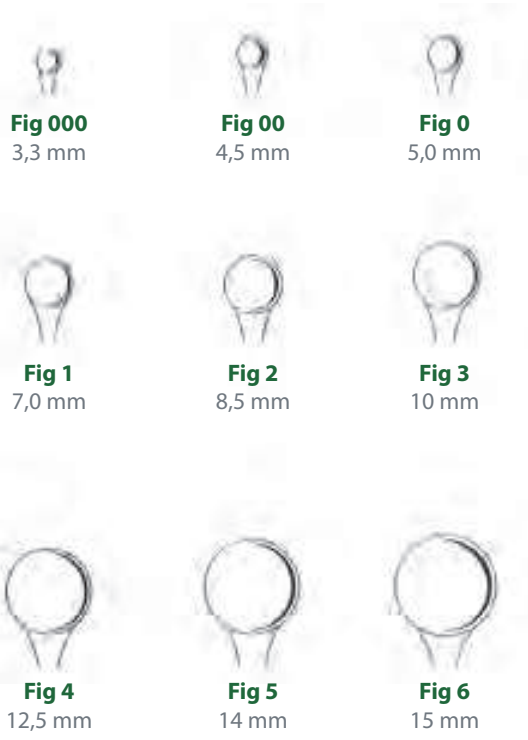

**Fig 000**  
3,3 mm

**Fig 00**  
4,5 mm

**Fig 0**  
5,0 mm

**Fig 1**  
7,0 mm

**Fig 2**  
8,5 mm

**Fig 3**  
10 mm

**Fig 4**  
12,5 mm

**Fig 5**  
14 mm

**Fig 6**  
15 mm

Fig 000	<b>J283100</b>
Fig 00	<b>J283101</b>
Fig 0	<b>J283102</b>
Fig 1	<b>J283103</b>
Fig 2	<b>J283104</b>
Fig 3	<b>J283105</b>
Fig 4	<b>J283106</b>
Fig 5	<b>J283107</b>
Fig 6	<b>J283108</b>

# LANDANGER

Instrumentation osseuse cures - Osseous instrumentation cures - Instrumentación osea cures

1/1

## BRUNS

Ovale - Oval - Ovalada

Droite  
Straight  
Recta

J283200	Fig 000
J283201	Fig 00
J283202	Fig 0
J283203	Fig 1
J283204	Fig 2
J283205	Fig 3
J283206	Fig 4
J283207	Fig 5
J283208	Fig 6

Coudée 45°  
Angled 45°  
Angulada 45°

J283210
J283211
J283212
J283213
J283214
J283215
J283216
J283217
J283218



**J283204**  
23 cm - 9"



**J283214**  
23 cm - 9"



# LANDANGER

Instrumentation osseuse currettes - Osseous instrumentation currettes - Instrumentación osea curretas



## CHARNLEY

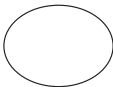

-  8 mm **J28350**
-  10 mm **J28360**
-  12 mm **J28370**

**J28350**  
40 cm - 15 3/4 "

## LETOURNEL

Curette  
Curette  
Cureta

Ciseau gouge  
Gouge  
Gubia

Burin  
Bone chisel  
Cinzel



**J28400**  
37 cm - 14 1/2 "



**J36650**  
37 cm - 14 1/2 "



**J32675**  
37 cm - 14 1/2 "

XIII - Osseux  
XIII - Bone surgery  
XIII - Cirugía osea

# LANDANGER

Instrumentation osseuse currettes - Osseous instrumentation currettes - Instrumentación osea curretas



## BESNIER

Pleine Full Llena		Ø		Fenêtrée Open work Con ventana
J28402		2 mm		J28412
J284030		3 mm		J284130
J28404		4 mm		J28414
J284050		5 mm		J284150
J284060		6 mm		J284160
J284070		7 mm		J284170
J284080		8 mm		J284180



**J28404**  
13 cm - 5"



**J28414**  
13 cm - 5"

# LANDANGER

Instrumentation osseuse curettes - Osseous instrumentation curettes - Instrumentación osea curetas



**VIDAL**

**BROCK**

**UNNA**

**WILLIGER**

Tranchant  
Sharp  
Cortant

Mousse  
Blunt  
Romo

Tire-comédon  
Comedone extractor  
Saca comedone

Ovale  
Oval  
Ovalada



**J28420**  
13,5 cm - 5 1/4 "



**J28425**  
13,5 cm - 5 1/4 "



**J284260**  
14 cm - 5 1/2 "



**J284275**  
13,5 cm - 5 1/4 "

XIII - Osseux  
XIII - Bone surgery  
XIII - Cirugía osea

# LANDANGER

Instrumentation osseuse ciseaux burins - Osseous instrumentation bone chisels - Instrumentación osea cinceles



## POIRIER

14 mm	J32060	
12 mm	J32050	
10 mm	J32040	
8 mm	J32030	
6 mm	J32020	
4 mm	J32010	



**J32030**  
16 cm - 6 1/4 "

## LUCAS-CHAMPIONNIERE



**J32235**  
21 cm - 8 1/4 "

**XIII - 26**

## FARABEUF

20 cm - 8 "

Standard Standard Estándar	Largeur Width Anchura	Lame souple Supple blade Hoja flexible
J320990	6 mm	-
J320991	8 mm	-
J320992	10 mm	J320800
J320993	12 mm	-
J32100	15 mm	J320802
J32110	20 mm	J320803
J321101	25 mm	J320804
J321102	30 mm	J320805

25 cm - 10 "

Standard Standard Estándar	Largeur Width Anchura	Lame souple Supple blade Hoja flexible
J32140	6 mm	-
J32150	8 mm	-
J32160	10 mm	J320810
J32170	12 mm	-
J32190	15 mm	J320812
J32200	20 mm	J320813
J32210	25 mm	J320814
J32220	30 mm	J320815



**J32100**  
20 cm - 8 "



**J320812**  
25 cm - 10 "

# LANDANGER

Instrumentation osseuse ciseaux burins - Osseous instrumentation bone chisels - Instrumentación osea cinceles



## STILLE

## OMBREDANNE



Manche léger  
Light handle  
Mango ligero

**J32240**  
20 cm - 8 "

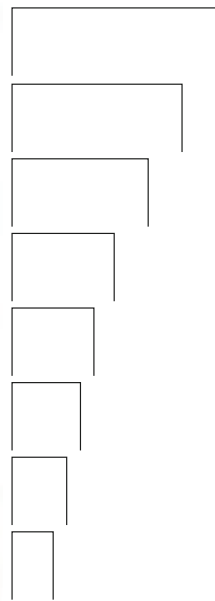

	20 cm - 8 "	25 cm - 10 "
30 mm	<b>J32310</b>	<b>J32390</b>
25 mm	<b>J32300</b>	<b>J32380</b>
20 mm	<b>J32290</b>	<b>J32370</b>
15 mm	<b>J32280</b>	<b>J32360</b>
12 mm	<b>J32270</b>	<b>J32350</b>
10 mm	<b>J32260</b>	<b>J32340</b>
8 mm	<b>J32250</b>	<b>J32330</b>
6 mm	<b>J32240</b>	<b>J32320</b>

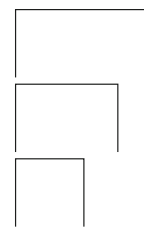

20 mm	<b>J32420</b>
15 mm	<b>J32410</b>
10 mm	<b>J32400</b>



Lame mince  
Thin blade  
Hoja fina

**J32400**  
14 cm - 5 1/2 "

**XIII - 28**



# LANDANGER

Instrumentation osseuse ciseaux burins - Osseous instrumentation bone chisels - Instrumentación osea cinceles

## MAC EVEN



Droit  
Straight  
Recto



Ostéotome  
Osteotome  
Osteotomo

Courbe  
Curved  
Curvo

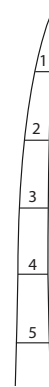

J32430
J32440

10 mm  
15 mm

J32450
J32460



**J32430**  
20 cm - 8"

**J32460**  
20 cm - 8"



## PAUWELLS

Ostéotome  
Osteotome  
Osteotomo

16 cm - 6 1/4"

24 cm - 9 1/2"

24 cm - 9 1/2"

Droit  
Straight  
Recto

Droit  
Straight  
Recto

Courbe  
Curved  
Curvo

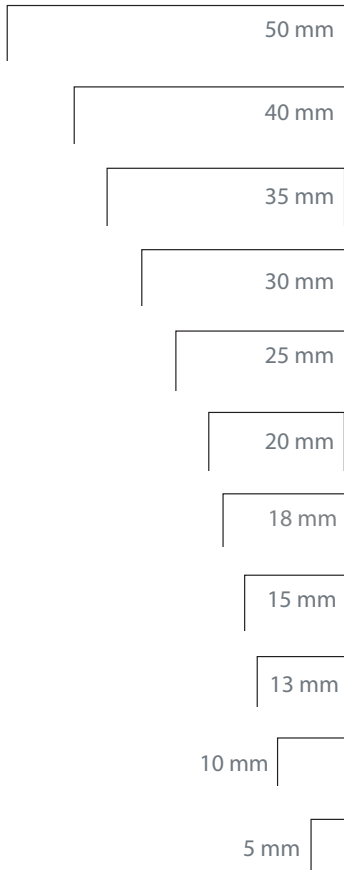

J32540	J32620	J325430
J32530	J32610	J325429
J32520	J32600	J325428
J32510	J32590	J325427
J32500	J32580	J325426
J32490	J32570	J325425
J324850	J32565	J325424
J32480	J32560	J325423
J324750	J32555	J325422
J32470	J32550	J325421
J32465	J325450	J325420



**J325450**  
24 cm - 9 1/2"



## LAMBOTTE

Ostéotome  
Osteotome  
Osteotomo

Acier extra dur  
Extra hard steel  
Acero extra duro



**J32621**  
23 cm - 9"

	<b>J32623</b>
25mm	
	<b>J32622</b>
20 mm	
	<b>J32621</b>
15 mm	
	<b>J32625</b>
10 mm	
	<b>J32624</b>
5 mm	

## LAMBOTTE (mini)

2 mm	<b>J324620</b>
3 mm	<b>J324621</b>
4 mm	<b>J324622</b>
6 mm	<b>J324623</b>
8 mm	<b>J324624</b>
10 mm	<b>J324625</b>
12 mm	<b>J324626</b>
15 mm	<b>J324627</b>

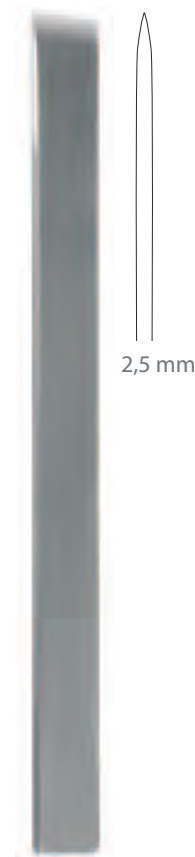

**J324625**  
12,5 cm - 5"

# LANDANGER

Instrumentation osseuse ciseaux burins - Osseous instrumentation bone chisels - Instrumentación osea cinceles



## DUPONT

Ostéotome  
Osteotome  
Osteotomo



Largeur  
Width  
Anchura

5 mm	J32678
10 mm	J32682
15 mm	J32684
20 mm	J32686
25 mm	J32688

**J32684**  
20 cm - 8"

**XIII - 32**



## CAUCHOIX

Ostéotome  
Osteotome  
Osteotomo



	25 mm	<b>J32665</b>
	20 mm	<b>J32660</b>
	18 mm	<b>J32650</b>
	16 mm	<b>J32640</b>
	14 mm	<b>J32630</b>
	12 mm	<b>J32629</b>
	10 mm	<b>J32628</b>
	8 mm	<b>J32627</b>

**J32650**  
25 cm - 10 "

# LANDANGER

Instrumentation osseuse ciseaux burins - Osseous instrumentation bone chisels - Instrumentación osea cinceles



## STILLE

Ostéotome  
Osteotome  
Osteotomo

21 cm - 8 1/4"

<b>J327006</b>	6 mm
<b>J327008</b>	8 mm
<b>J327010</b>	10 mm
<b>J327012</b>	12 mm
<b>J327015</b>	15 mm
<b>J327020</b>	20 mm
<b>J327025</b>	25 mm
<b>J327030</b>	30 mm

25 cm - 10"

<b>J327106</b>	
<b>J327108</b>	
<b>J327110</b>	
<b>J327112</b>	
<b>J327115</b>	
<b>J327120</b>	
<b>J327125</b>	
<b>J327130</b>	

## LEXER

Ostéotome  
Osteotome  
Osteotomo

10 mm	<b>J329010</b>
15 mm	<b>J329015</b>
20 mm	<b>J329020</b>
25 mm	<b>J329025</b>

Manche CELERON  
CELERON handle  
Mango CELERON



**J327008**  
21 cm - 8 1/4"



**J329010**  
22 cm - 8 3/4"

# LANDANGER

Instrumentation osseuse gouges - Osseous instrumentation gouges - Instrumentación osea gubias



## GUILLAUME

## NANCY

8 mm	<b>J36040</b>	
7 mm	<b>J36030</b>	
6 mm	<b>J36020</b>	
5 mm	<b>J36044</b>	
4 mm	<b>J36042</b>	

10 mm	<b>J36080</b>	
8 mm	<b>J36070</b>	
6 mm	<b>J36060</b>	



**J36040**  
25 cm - 10"



**J36060**  
25 cm - 10"

# LANDANGER

Instrumentation osseuse gouges - Osseous instrumentation gouges - Instrumentación osea gubias



## POIRIER



	14 mm	<b>J36150</b>
	12 mm	<b>J36140</b>
	10 mm	<b>J36130</b>
	8 mm	<b>J36120</b>
	6 mm	<b>J36110</b>
	4 mm	<b>J36100</b>

**J36100**  
16 cm - 6 1/4 "











# LANDANGER

Instrumentation osseuse gouges - Osseous instrumentation gouges - Instrumentación osea gubias



## STILLE



Largeur Width Anchura	Longueur - Length - Largo	
	20 cm - 8 "	25 cm - 10 "
 30 mm	<b>J36250</b>	<b>J36330</b>
 25 mm	<b>J36240</b>	<b>J36320</b>
 20 mm	<b>J36230</b>	<b>J36310</b>
 15 mm	<b>J36220</b>	<b>J36300</b>
 12 mm	<b>J36210</b>	<b>J36290</b>
 10 mm	<b>J36200</b>	<b>J36280</b>
 8 mm	<b>J36190</b>	<b>J36270</b>
 6 mm	<b>J36180</b>	<b>J36260</b>

Manche léger  
Light handle  
Mango ligero

**J36200**  
20 cm - 8 "

# LANDANGER

Instrumentation osseuse gouges - Osseous instrumentation gouges - Instrumentación osea gubias



## SMITH PETERSEN

Modèle Lyon  
Lyon's mode  
Modelo Lyon



	30 mm	<b>J36345</b>
	27 mm	<b>J36340</b>
	22 mm	<b>J36335</b>

Contre coudé  
Conterbent  
Curva doble



**J36345**  
23,5 cm - 9 1/4 "

**XIII - 38**

# LANDANGER

Instrumentation osseuse gouges - Osseous instrumentation gouges - Instrumentación osea gubias

## CAUCHOIX



Concave  
Concave  
Concava

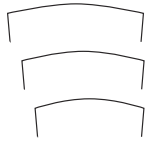

	25 cm - 10 "	30 cm - 11 3/4 "
20 mm	<b>J36370</b>	<b>J36400</b>
18 mm	<b>J36360</b>	<b>J36390</b>
16 mm	<b>J36350</b>	<b>J36380</b>

Convexe  
Convexe  
Convexa

	25 cm - 10 "	30 cm - 11 3/4 "
20 mm	<b>J36430</b>	<b>J36460</b>
18 mm	<b>J36420</b>	<b>J36450</b>
16 mm	<b>J36410</b>	<b>J36440</b>



**J36370**  
25 cm - 10 "



**J36430**  
25 cm - 10 "





# LANDANGER

Instrumentation osseuse gouges - Osseous instrumentation gouges - Instrumentación osea gubias



## FARABEU



	14 mm	<b>J36600</b>
	12 mm	<b>J36590</b>
	10 mm	<b>J36580</b>
	8 mm	<b>J36570</b>
	6 mm	<b>J36560</b>

**J36600**  
25 cm - 10"

**XIII - 40**

# LANDANGER

Instrumentation osseuse gouges - Osseous instrumentation gouges - Instrumentación osea gubias



## STAGNARA



16 mm

J36635



14 mm

J36625



12 mm

J36620

Manche antidérapant  
Antislipping handle  
Mango antideslizante

**J36635**  
30 cm - 11 <sup>3</sup>/<sub>4</sub>"

# LANDANGER

Instrumentation osseuse gouges - Osseous instrumentation gouges - Instrumentación osea gubias



## COBB



Droite  
Straight  
Recta

**J36700**

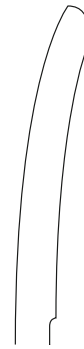

1/2 courbe  
Half curved  
Media curva

**J36705**

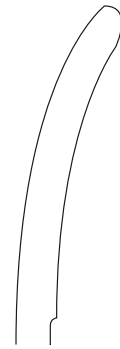

Courbe  
Curved  
Curva

**J36710**

Manche antidérapant  
Antislipping handle  
Mango antideslizante

**J36700**  
30 cm - 11 <sup>3</sup>/<sub>4</sub> "

**XIII - 42**

# LANDANGER

Instrumentation osseuse maillets - Osseous instrumentation mallets - Instrumentación osea mazos

## OMBREDANNE

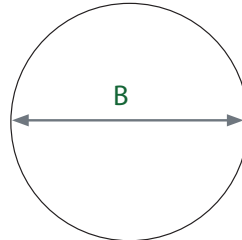

Poids Weight Peso	A	B	
500 g - 1, 1 lbs	57 mm	30 mm	<b>J40010</b>
700 g - 1,54 lbs	61 mm	35 mm	<b>J40020</b>
900 g - 1,98 lbs	64 mm	40 mm	<b>J40025</b>
1200 g - 2,65 lbs	64 mm	45 mm	<b>J40030</b>

**J40010**  
22 cm - 8 3/4"

# LANDANGER

Instrumentation osseuse maillets - Osseous instrumentation mallets - Instrumentación osea mazos



## MAC EVEN

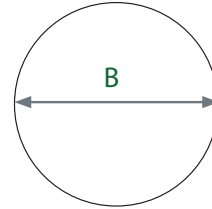

Poids Weight Peso	A	B	
250 g - 0,55 lbs	40 mm	25 mm	J40040
400 g - 0,88 lbs	45 mm	30 mm	J40045
500 g - 1,10 lbs	52 mm	35 mm	J40050
700 g - 1,54 lbs	60 mm	40 mm	J40055

**J40040**  
22 cm - 8 1/2"

**XIII - 44**



# LANDANGER

Instrumentation osseuse maillets - Osseous instrumentation mallets - Instrumentación osea mazos



## MAC EVEN

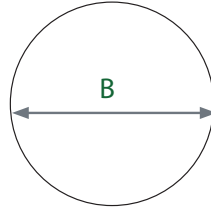

Poids Weight Peso	A	B	
250 g - 0,55 lbs	52 mm	25 mm	<b>J40060</b>
350 g - 0,77 lbs	52 mm	30 mm	<b>J40070</b>
500 g - 1,10 lbs	48 mm	35 mm	<b>J40075</b>
600 g - 1,32 lbs	52 mm	40 mm	<b>J40080</b>
750 g - 1,65 lbs	52 mm	45 mm	<b>J40090</b>

**J40060**  
22 cm - 8 1/2"

**XIII - 45**

# LANDANGER

Instrumentation osseuse maillets - Osseous instrumentation mallets - Instrumentación osea mazos

1/1



## JUDET

600 g - 1,32 lbs **J401180**

800 g - 1,76 lbs **J401190**

1000 g - 2,20 lbs **J40120**

**J40120**  
25 cm - 10"



180 g - 0,40 lbs **J401300**

350 g - 0,77 lbs **J401301**

500 g - 1,10 lbs **J401302**

700 g - 1,54 lbs **J401303**

Manche CELERON  
CELERON handle  
Mango CELERON

**J401301**  
22 cm - 8 1/2"

**XIII - 46**

# LANDANGER

## Instrumentation osseuse poinçons - Osseous instrumentation punch - Instrumentación osea punzones

### ISSELIN

Avec œillet  
With hole  
Con agujero

2,5 mm **J440070**

Sans œillet  
Without hole  
Sin agujero

2,5 mm **J440075**



**J440075**  
16,5 cm - 6 1/2 "

### OMBREDANNE

Pointe carrée  
Square point  
Punta cuadrada

2 mm **J44032**

3 mm **J44035**

4 mm **J44010**

5 mm **J44020**



**J44005**  
13 cm - 5 1/8 "



**J44010**  
16 cm - 6 5/16 "



**J44060**  
22 cm - 8 3/4 "

3 mm **J44040**

4 mm **J44050**

5 mm **J44060**

6 mm **J44066**

7 mm **J44070**

22 cm - 8 3/4 "

3 mm **J44045**

4 mm **J44055**

5 mm **J44065**

6 mm **J44068**

7 mm **J44071**

25 cm - 10 "

# LANDANGER

Instrumentation osseuse poinçons - Osseous instrumentation punch - Instrumentación osea punzones



## MERLE D'AUBIGNE



Triangulaire  
Triangular  
Triangular

Ø

3 mm **J44075**

4 mm **J44085**

5 mm **J44100**

6 mm **J44105**

7 mm **J44110**

**J44100**  
22 cm - 8 3/4 "



Quadrangulaire  
Quadrangular  
Cuadrangular



4 mm **J44115**

5 mm **J44116**

6 mm **J44117**

**J44116**  
22 cm - 8 3/4 "

# LANDANGER

Instrumentation osseuse poinçons et trépan - Osseous instrumentation punch - Instrumentación osea punzones

## ROCHER

- 15 cm - 6" **J44121**
- 18 cm - 7" **J44122**
- 20 cm - 8" **J44123**



1/1

Ø  
3 mm

**J44121**  
15 cm - 6"

## FICAT

3/4

Ø

- 8 mm **J442008**
- 10 mm **J442010**
- 12 mm **J442012**



**J442008**  
34,5 cm - 13 1/2"

# LANDANGER

Instrumentation osseuse crochets - Osseous instrumentation hooks - Instrumentación osea ganchuras



## KOENING



Pointu  
Sharp  
Agudo

**J48020**  
24 cm - 9 1/2 "

## LAMBOTTE



**J48040**  
25 cm - 10 "

**J48050**  
27 cm - 10 3/4 "

**J48030**  
23 cm - 9 "

**XIII - 50**

# LANDANGER

Instrumentation osseuse mesureurs - Osseous instrumentation measures - Instrumentación osea medidores

1/1



**J56040**  
20 cm - 8 "

**J56050**  
30 cm - 11 <sup>3</sup>/<sub>4</sub> "

**J56055**  
50 cm - 19 <sup>3</sup>/<sub>4</sub> "



**J56070**

XIII - Osseux  
XIII - Bone surgery  
XIII - Cirugía osea

# LANDANGER

Pinces gouges - Bone rongeur forceps - Pinzas gubias



Droite  
Straight  
Recta

Courbe  
Curved  
Curva



**J64020**  
5 mm



**J64030**  
7 mm



**J64040**  
9 mm

**J64040**  
17 cm - 6 <sup>3</sup>/<sub>4</sub> "

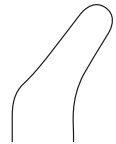

**J64060**  
5 mm

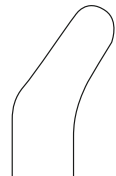

**J64070**  
7 mm



**J64080**  
9 mm

**J64060**  
17 cm - 6 <sup>3</sup>/<sub>4</sub> "



# LANDANGER

Pinces gouges - Bone rongeur forceps - Pinzas gubias



Droite  
Straight  
Recta

Courbe  
Curved  
Curva



**J64090**  
8 mm



**J64100**  
10 mm

**J64090**  
20 cm - 8 "

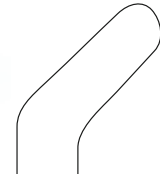

**J64120**  
8 mm

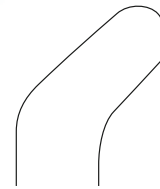

**J64130**  
10 mm

**J64130**  
20 cm - 8 "

# LANDANGER

Pinces gouges - Bone rongeur forceps - Pinzas gubias

1/1



**J64150**  
23 cm - 9 "

Mors carrés  
Quadrangular jaws  
Bocas cuadradas

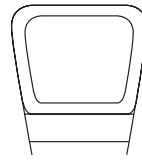

Droite  
Straight  
Recta

**J64150**  
23 cm - 9 "

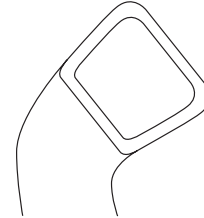

Courbe  
Curved  
Curva

**J64160**  
23 cm - 9 "

# LANDANGER

Pinces gouges - Bone rongeur forceps - Pinzas gubias



## LEMPERT

## LOMBARD



Droite  
Straight  
Recta

**J64190**

3 mm



Courbe  
Curved  
Curva

**J64192**

3 mm

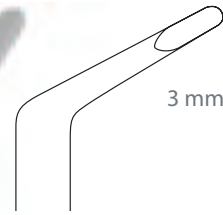

3 mm

**J64192**  
19 cm - 7 1/2 "

**J64260**  
18 cm - 7 "

# LANDANGER

Pinces gouges - Bone rongeur forceps - Pinzas gubias



## STILLE



**J64200**  
23 cm - 9"



**J64200**  
6 mm

Droite  
Straight  
Recta



**J64210**  
8 mm



**J64240**  
6 mm

Courbe  
Curved  
Curva

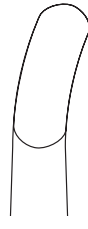

**J64250**  
8 mm



**J64220**  
6 mm

Coudée  
Angular  
Acodada



**J64230**  
8 mm

# LANDANGER

Pinces gouges - Bone rongeur forceps - Pinzas gubias

ECHLIN



**J64254**  
23 cm - 9 "



**J64254**  
2 x 10 mm

Coudée  
Angular  
Acodada



**J64256**  
3 x 10 mm

# LANDANGER

Pinces gouges - Bone rongeur forceps - Pinzas gubias



SAUERBRUCH

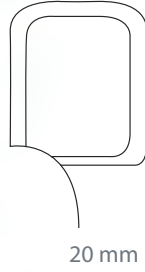

20 mm

J64280

31 cm - 12 1/4 "

DAVID



6 mm

J64370

26 cm - 10 1/4 "

XIII - 58

# LANDANGER

Pinces gouges - Bone rongeur forceps - Pinzas gubias

VINCENT

SICARD



**J64290**  
20 cm - 8 "

Mors courts  
Short jaws  
Bocas cortas



**J64310**  
20 cm - 8 "

**J64350**  
24 cm - 9 1/2 "

Mors longs  
Long jaws  
Bocas largas



**J64290**  
20 cm - 8 "

**J64330**  
24 cm - 10 1/2 "

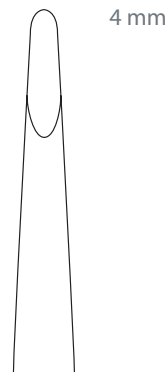

**J64340**  
25 cm - 10 "



**J64380**  
23 cm - 9 "

6 mm



# LANDANGER

Pinces gouges - Bone rongeur forceps - Pinzas gubias

1/1

**BOEHLER**

**BEYER**



**J64384**  
15 cm - 6 "



**J64384**  
3 mm



**J64386**  
3 mm



**J643850**  
2 mm



**J64390**  
18 cm - 7 "



**J643950**  
2,5 mm  
18 cm - 7 "



**J64390**  
4 mm  
18 cm - 7 "



**J64410**  
6 mm  
20 cm - 8 "

**XIII - 60**

XIII - Osseux  
XIII - Bones surgery  
XIII - Cirurgia osea



# LANDANGER

Pinces gouges - Bone rongeur forceps - Pinzas gubias



## LUER-FRIEDMANN

## MINI-FRIEDMANN



**J64400**  
14 cm - 5 1/2 "



**J644005**  
12,5 cm - 5 "

# LANDANGER

Pinces gouges - Bone rongeur forceps - Pinzas gubias



## SMITH - PETERSEN



**J64412**  
19 cm - 7 1/2 "

**J64414**  
23 cm - 9 "

## LEKSELL- STILLE



**J64416**  
3 mm

**J64418**  
5 mm

**J64422**  
8 mm

# LANDANGER

Pinces gouges - Bone rongeur forceps - Pinzas gubias



## BEYER-ZAUFAL



**J64480**  
18 cm - 7 "

## MARQUARDT



**J644850**  
20 cm - 8 "

# LANDANGER

## Pinces gouges - Bone rongeur forceps - Pinzas gubias



### LUER

Droite  
Straight  
Recta

Courbe  
Curved  
Curva

-	15 cm - 6 "	J64490	4 mm
J644950	17 cm - 6 <sup>3</sup> / <sub>4</sub> "	J644960	8 mm
J644970	18,5 cm - 7 <sup>1</sup> / <sub>4</sub> "	J644980	Forte - Strong - Forte



**J64490**  
15 cm - 6 "

# LANDANGER

Pinces gouges - Bone rongeur forceps - Pinzas gubias

## BLUMENTHAL

## MEAD



Légèrement courbe  
Lightly curved  
Ligeramente curva

Courbe  
Curved  
Curva

Coudée  
Angled  
Angulada

Mors carrés  
Square jaws  
Bocas cuadradas

Mors ronds  
Round jaws  
Bocas redondas



**J644990**  
15,5 cm - 6 "



**J644995**  
15,5 cm - 6 "



**J644996**  
15,5 cm - 6 "



**J645205**  
16,5 cm - 6 1/2 "



**J645200**  
16,5 cm - 6 1/2 "



# LANDANGER

Pinces coupantes - Bone cutting forceps - Pinzas cortantes



## LISTON

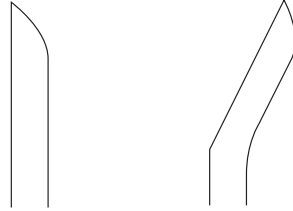

Droite  
Straight  
Recta

Coudée  
Angular  
Acodada

14 cm - 5 1/2 "

**J68022**

**J68024**

17 cm - 6 3/4 "

**J68026**

**J68028**

19 cm - 7 1/2 "

**J68030**

**J68040**

22 cm - 8 3/4 "

**J68050**

**J68060**



**J68022**

14 cm - 5 1/2 "

# LANDANGER

Pinces coupantes - Bone cutting forceps - Pinzas cortantes

## LISTON

Double doigt  
Double Collin's lock  
Doble articulación

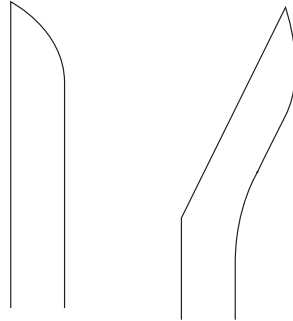

Droite  
Straight  
Recta

Coudée  
Angular  
Acodada

19 cm - 7 1/2 "

**J68062**

**J68064**

22 cm - 8 3/4 "

**J68066**

**J68068**



**J68062**  
19 cm - 7 1/2 "



Cisaille  
Shear  
Cizalla



**J68130**  
25 cm - 10 "

**XIII - 67**

# LANDANGER

Pinces coupantes - Bone cutting forceps - Pinzas cortantes



## BOEHLER

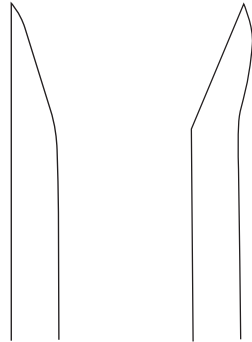

Droite  
Straight  
Recta

Coudée  
Angular  
Acodada

15 cm - 6 "

**J68010**

**J68012**



**J68010**  
15 cm - 6 "

## MAC INDOE



Coudée  
Angular  
Acodada

**J68015**  
17 cm - 6 <sup>3</sup>/<sub>4</sub> "

**J68020**  
19 cm - 7 <sup>1</sup>/<sub>2</sub> "

**XIII - 68**



# LANDANGER

Pinces coupantes - Bone cutting forceps - Pinzas cortantes

RUSKIN-LISTON



**J68275**  
19 cm - 7 1/2 "



**Droite**  
Straight  
Recta

**J68275**



**Coudée**  
Angular  
Acodada

**J68280**

# LANDANGER

Pinces coupantes - Bone cutting forceps - Pinzas cortantes

1/1

## LISTON



Droite  
Straight  
Recta

24 cm - 9 1/2 ''

**J68090**



Coudée  
Angular  
Acodada

**J68100**

**XIII - 70**

# LANDANGER

Pinces coupantes - Bone cutting forceps - Pinzas cortantes

## LISTON-KEY (HORSLEY)

Contre-coudée - Forte  
Conterbent - Strong  
Curva doble - Fuerte



**J68110**  
28 cm - 11 "

## LISTON



Courbe - Forte  
Curved - Strong  
Curva - Fuerte



**J68120**  
28 cm - 11 "

# LANDANGER

Pinces coupantes - Bone cutting forceps - Pinzas cortantes



## COLLIN

Costotome  
Costotome  
Costotomo

Enfants  
Children  
Niños

**J68170**  
17 cm - 6 <sup>3</sup>/<sub>4</sub> "

Adultes  
Adults  
Adultos

**J68180**  
19 cm - 7 <sup>1</sup>/<sub>2</sub> "



**J68180**  
19 cm - 7 <sup>1</sup>/<sub>2</sub> "

## MAURER



Costotome  
Costotome  
Costotomo

Double doigt  
Double Collin's lock  
Doble articulación

A vis  
With screw  
Con tornillo

A droite  
Right curved  
Derecha

J68210

J68240

A gauche  
Left curved  
Izquierda

J68220

J68230



**J68210**  
31 cm - 12 1/4"



**J68240**  
24 cm - 9 1/2"

# LANDANGER

Pinces coupantes - Bone cutting forceps - Pinzas cortantes



SAUERBRUCH

SAUERBRUCH-FREY



**J681600**  
26 cm - 10 1/4"



**J681601**  
36 cm - 14 1/4"

**XIII - 74**

XIII - Osseux  
XIII - Bones surgery  
XIII - Cirugia osea

# LANDANGER

Pinces coupantes - Bone cutting forceps - Pinzas cortantes

TRICOISE DE VELPEAU

DOYEN

LEBSCHE



Costotome  
Costotome  
Costotomo

Sternotome  
Sternum chisel  
Cinzel par esternón



**J68250**  
24 cm - 9 1/2"



**J68260**  
18 cm - 7"



**J68270**  
24 cm - 9 1/2"

# LANDANGER

Daviers - Bone holding forceps - Pinzas para huesos



## VERBRUGGE

Pour os de la main  
For hand bones  
Para huesos de la mano

Réducteur - 1 mors denté - 1 mors acéré  
Reducing - 1 toothed jaw - 1 sharped jaw  
Reductor - 1 boca dentada - 1 boca acerada

Préhenseur - 2 mors dentés  
Prehensile - 2 toothed jaws  
Prensador - 2 bocas dentadas



**J72010**  
15 cm - 6"



**J72350**  
16 cm - 6 1/4"

**J72400**  
16 cm - 6 1/4"

**XIII - 76**



# LANDANGER

Daviers - Bone holding forceps - Pinzas para huesos



## FARABEUF

<b>J72020</b>	17 cm - 6 <sup>3</sup> / <sub>4</sub> "	<b>J72030</b>
<b>J72040</b>	19 cm - 7 <sup>1</sup> / <sub>2</sub> "	<b>J72050</b>
<b>J72060</b>	26 cm - 10 <sup>1</sup> / <sub>4</sub> "	<b>J72070</b>



Sans crémaillère  
Without ratchet  
Sin cremallera

**J72020**  
17 cm - 6 <sup>3</sup>/<sub>4</sub> "



A crémaillère  
With ratchet  
Con cremallera

**J72030**  
17 cm - 6 <sup>3</sup>/<sub>4</sub> "

# LANDANGER

Daviers - Bone holding forceps - Pinzas para huesos

1/1

OLLIER



**J72090**  
23 cm - 9"

Dents de lion  
Lion's teeth  
Dientes de león



**J72100**  
19 cm - 7 1/2"

Pour résection  
For resection  
Para resección



**J72110**  
19 cm - 7 1/2"

**XIII - 78**

# LANDANGER

## Daviers - Bone holding forceps - Pinzas para huesos

### OLLIER



- 16 cm - 6 1/4" **J72120**
- 18 cm - 7" **J72130**
- 22 cm - 8 3/4" **J72140**

Pour os mous  
For soft bones  
Para hueso muelles



Sans crémaillère  
Without ratchet  
Sin cremallera

**J72130**  
18 cm - 7"

- 19 cm - 7 1/2" **J72150**
- 22 cm - 8 3/4" **J72160**
- 27 cm - 10 3/4" **J72170**

Pour rotule  
For the kneecap  
Para rotula



A crémaillère  
With ratchet  
Con cremallera

**J72150**  
19 cm - 7 1/2"

# LANDANGER

Daviers - Bone holding forceps - Pinzas para huesos



SEMB

DIGMANN

MUSEUX



**J72180**  
22 cm - 8 3/4"



**J72190**  
19 cm - 7 1/2"  
**J721901 (modifié)**  
19 cm - 7 1/2"



**J72195**  
24 cm - 9 1/2"

**XIII - 80**

XIII - Osseux  
XIII - Bones surgery  
XIII - Cirugía osea

# LANDANGER

Daviers - Bone holding forceps - Pinzas para huesos

## LAMBOTTE



Droit  
Straight  
Recta



**J72200**  
22 cm - 8 3/4 "



**J72200**  
22 cm - 8 3/4 "



**J72210**  
26 cm - 10 1/4 "



**J72220**  
33 cm - 13 "

# LANDANGER

## Daviers - Bone holding forceps - Pinzas para huesos

1/1

### LAMBOTTE

En L  
L model  
En forma de L



**J72230**  
22 cm - 8 3/4 "



**J72240**  
26 cm - 10 1/4 "



**J72250**  
35 cm - 13 3/4 "

**J72230**  
22 cm - 8 3/4 "

En S  
S model  
En forma de S

3/4



**J72270**  
26 cm - 10 1/4 "

**J72260**  
22 cm - 8 3/4 "

**J72270**  
26 cm - 10 1/4 "

**J72280**  
33 cm - 13 "

# LANDANGER

Daviers - Bone holding forceps - Pinzas para huesos

LANE



J72310

21 cm - 8 1/4 "

J72320

J72330

34 cm - 13 1/2 "

J72340



Sans crémaillère  
Without ratchet  
Sin cremallera

**J72310**  
21 cm - 8 1/4 "



A crémaillère  
With ratchet  
Con cremallera

**J72320**  
21 cm - 8 1/4 "

# LANDANGER

Daviers - Bone holding forceps - Pinzas para huesos



VERBRUGGE



Préhenseur - 2 mors dentés  
Prehensile - 2 toothed jaws  
Prensador - 2 bocas dentadas



15 cm - 6 "	J72355
18 cm - 7 "	J72360
24 cm - 9 1/2 "	J72370
26 cm - 10 1/4 "	J72380
28 cm - 11 "	J72390

Réducteur - 1 mors denté - 1 mors acéré  
Reducing - 1 toothed jaw - 1 sharpened jaw  
Reductor - 1 boca dentada - 1 boca acerada



15 cm - 6 "	J72405
18 cm - 7 "	J72410
24 cm - 9 1/2 "	J72420
26 cm - 10 1/4 "	J72430
28 cm - 11 "	J72440

**J72360**  
18 cm - 7 "



# LANDANGER

Daviers - Bone holding forceps - Pinzas para huesos

VERBRUGGE



1 mors porte plaque - 1 mors acéré  
1 plate bearer jaw - 1 sharped jaw  
1 boca porta placa - 1 boca acerada



**J72460**  
10 mm  
24 cm - 9 1/2 "



**J72470**  
13 mm  
26 cm - 10 1/4 "



**J72480**  
16 mm  
28 cm - 11 "



**J72460**  
24 cm - 9 1/2 "

XIII - Osseux  
XIII - Bone surgery  
XIII - Cirugía osea

# LANDANGER

Daviers - Bone holding forceps - Pinzas para huesos



## VERBRUGGE

24 cm - 9 1/2 "

J72490

26 cm - 10 1/4 "

J72500

28 cm - 11 "

J72510



1 mors fixe - 1 mors mobile  
1 fixed jaw - 1 moving jaw  
1 boca fija - 1 boca móvil

**J72500**  
26 cm - 10 1/4 "

**XIII - 86**

# LANDANGER

## Daviers - Bone holding forceps - Pinzas para huesos



15 cm - 6 "	<b>J725200</b>
19 cm - 7 1/2 "	<b>J725201</b>
24 cm - 9 1/2 "	<b>J725202</b>
26 cm - 10 1/4 "	<b>J725203</b>
28 cm - 11 "	<b>J725204</b>

Pinces à sequestre  
Sequester forceps  
Pinzas para secuestro

Droite  
Straight  
Recta

Courbe  
Curved  
Curva

Auto-centreur avec système d'arrêt fileté  
Auto-centering with threaded blocking system  
Auto-centrador con sistema de bloqueo roscado



**J725200**  
15 cm - 6 "



**J72550**  
21 cm - 8 1/4 "



**J72560**

Double courbure  
Double curved  
Doble curvatura



**J72570**

# LANDANGER

## Daviers - Bone holding forceps - Pinzas para huesos

1/1

Réducteurs  
Reducing  
Reductor



**J72575**  
20 cm - 8 "



**J725800**  
15 cm - 6 "

Préhenseur  
Prehensile  
Prensador



**J725850**  
15 cm - 6 "

**XIII - 88**

# LANDANGER

Daviers - Bone holding forceps - Pinzas para huesos



## LANDANGER

2 mors dentés  
2 toothed jaws  
2 bocas dentadas



**J72595**  
26 cm - 10 1/4"

Humérus  
Humerus  
Humero



**J72600**

Tibia  
Tibia  
Tibia



**J72595**

Fémur  
Femur  
Femur



**J72590**

# LANDANGER

Daviers - Bone holding forceps - Pinzas para huesos



## LANDANGER

1 mors denté - 1 mors acéré  
1 toothed jaws - 1 sharped jaw  
1 boca dentadas - 1 boca acerada



Humérus  
Humerus  
Humero



**J72612**

Tibia  
Tibia  
Tibia



**J72610**

Fémur  
Femur  
Femur



**J72605**

**J72605**  
26 cm - 10 1/4"

**XIII - 90**

# LANDANGER

Daviers - Bone holding forceps - Pinzas para huesos

## LANDANGER



1 mors porte plaque - 1 mors acéré  
1 plate bearer jaws- 1 sharped jaw  
1 boca porta-placa - 1 boca acerada

### TIBIA



**J72620**  
26 cm - 10 1/4"

### FEMUR



**J72615**  
26 cm - 10 1/4"

# LANDANGER

Divers - Miscellaneous - Diversas

1/1



Ciseaux à décapsuler  
Scissors to take capsules off  
Tijeras para decapsular

**J72700**  
25 cm - 10"



Pince à décapsuler  
Forceps to take capsules off  
Pinzeras para decapsular

**J72705**  
21 cm - 8 1/4"

**XIII - 92**



# LANDANGER

Divers - Miscellaneous - Diversas

LOWMAN-HOGLUND



**J727500**  
19 cm - 7 1/2"

LOUTE



**J731100**  
21 cm - 8 1/4"

DANIS



**J731200**  
21 cm - 8 1/4"



Tendeur automatique  
Automatic tightener  
Tensor automático

# LANDANGER

Ecarteurs main de plomb - Retractors lead hands - Separadores manos de plomo

1/3

## CHARNLEY

Grande valve seule  
Large blade only  
Valvula grande sóla

**J732010**  
25 x 40 mm

Petite valve seule  
Small blade only  
Valvula pequena sóla

**J732005**  
25 x 50 mm



**J732020**  
Poids seul avec chaîne  
Weight only with chain  
Peso sólo con cadena

Main de plomb adulte  
Adult lead hands  
Manos de plomo adulto



**XIII - 94**  
**J733000**  
33 cm - 13"

Main malléable siliconnée  
Malleable hand silicone  
Manos maleable silicona



**J733060**  
33 cm - 13"

**J733050**  
Non lestée  
No weighted  
Sin ponderada

**J733060**  
Lestée  
Weighted  
Ponderada

# LANDANGER

Chasse-greffon - Graft remover - Expulsa injerto



## TRILLAT



**J804520**  
20 cm - 8"



**J804510**  
9 x 9 mm

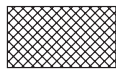

**J804520**  
9 x 16 mm

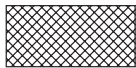

**J804530**  
9 x 19 mm



**J80460**  
18 cm - 7"



**J80460**  
6 x 13 mm

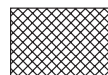

**J80470**  
10 x 15 mm

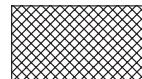

**J80480**  
11 x 20 mm

## DEMOISELLE



**J804850**  
18 cm - 7"



**J804850**  
5 x 8 mm



**J804860**  
8 x 12 mm

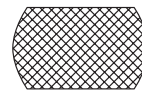

**J804870**  
12 x 20 mm

# LANDANGER

## Chasse-greffon - Graft remover - Expulsa injerto



Double  
Double  
Doble

Simple  
Simple  
Simple



**J80510**  
18 cm - 7"



**J805050**

3 mm



**J80510**

4 mm



**J80520**

6 mm



**J80530**

8 mm



**J805310**

10 mm

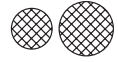

**J80540**

6 x 8 mm

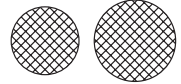

**J80550**

10 x 12 mm



**J80540**  
21 cm - 8 1/4"

MERLE D'AUBIGNE



Ecarteur pour épaule  
Shoulder retractor  
Separador para hombro

**J82010**  
29 cm - 11 1/2"



Passe fil avec aiguille  
Wire guide with needle  
Pasa hilo con aguja

**J82020**  
24 cm - 9 1/2"

# LANDANGER

Instrumentation osseuse Bankart - Osseous instrumentation Bankart - Instrumentación osea Bankart



POZZI

MERLE D'AUBIGNE

BANKART



**J82030**  
23 cm - 9"



**J82040**  
23 cm - 9"



**J82050**  
21 cm - 8 1/4"

**XIII - 98**

XIII - Osseux  
XIII - Bones surgery  
XIII - Cirugía osea

# LANDANGER

Instrumentation osseuse Danis - Osseous instrumentation Danis - Instrumentación osea Danis



**J84010**  
23 cm - 9"

**DANIS**

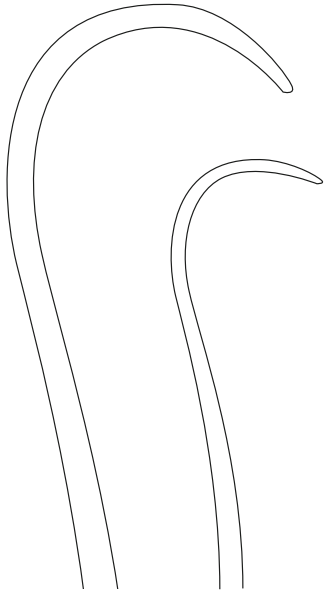

**J84030**    **J84010**

Ecarteur  
Retractor  
Separador

45 mm



**J84040**  
24 cm - 9 1/2"



Spatule  
Spatula  
Espátula

**A**

25 mm	<b>J84010</b>
30 mm	<b>J84020</b>
40 mm	<b>J84030</b>

# LANDANGER

Instrumentation osseuse Danis - Osseous instrumentation Danis - Instrumentación osea Danis



## DANIS

Refouloir  
Tamping tool  
Recalcador

Ø 12 mm



**J84070**  
17,5 cm - 6 <sup>3</sup>/<sub>4</sub> "

Passe fil  
Wire guide  
Pasa hilo



**J84130**  
21 cm - 8 <sup>1</sup>/<sub>4</sub> "



**J84120**  
19 cm - 7 <sup>1</sup>/<sub>2</sub> "



**J84110**  
17,5 cm - 6 <sup>3</sup>/<sub>4</sub> "



## KIRSCHNER



A

115 mm	J90030
135 mm	J90040
155 mm	J90050

Clé  
Wrench  
Llave



**J90080**

Crochet seul  
Hook only  
Ganchura sólo



**J90100**

13 cm - 5"

**J90040**



Tendeur  
Tensioner  
Tensor

**J90090**

20 cm - 8"

# LANDANGER

Instrumentation osseuse étrier - Osseous instrumentation wire traction bow - Instrumentación osea estribos

4/5



**XIII - 102**

# LANDANGER

Instrumentation osseuse étrier - Osseous instrumentation wire traction bow - Instrumentación osea estribos



A

55 - 120 mm	J90110
65 - 130 mm	J90120
90 - 200 mm	J90130
90 - 250 mm	J90140

Extensible - Avec 2 crochets  
Adjustable - With 2 hooks  
Extensible - Con 2 ganchuras



Crochets seuls (paire)  
Hooks only (pair)  
Ganchuras sólos (par)



J90150

# LANDANGER

Instrumentation osseuse étrier - Osseous instrumentation wire traction bow - Instrumentación osea estribos



## BOEHLER

A	B	
60 mm	100 mm	J90220
90 mm	110 mm	J90230
90 mm	140 mm	J90240



XIII - 104

# LANDANGER

Instrument à ménisque - Meniscus instruments - Instrumentation para menisco

## SMILLIE-TRILLAT



Tranchant droit  
Cutting straight  
Cortante recto

Tranchant droit et courbe  
Cutting straight and curved  
Cortante recto y curvo

Tranchant à gauche  
Left intended blade  
Cortante a la izquierda

Tranchant à droite  
Right intended blade  
Cortante a la derecha

8 mm  
17 cm - 6 <sup>3</sup>/<sub>4</sub> "



J80010



J80015



J80020



J80030

# LANDANGER

Instrument à ménisque - Meniscus instruments - Instrumentation para menisco



## SMILLIE-TRILLAT

Courbe étroit  
Curved narrow  
Curvo estrecho

Très courbe étroit  
Very curved narrow  
Muy curvo estrecho



**J80075**  
15 cm - 6 "



**J80110**  
15 cm - 6 "

# LANDANGER

Instrument à ménisque - Meniscus instruments - Instrumentation para menisco



## SMILLIE-TRILLAT

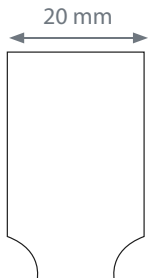

Courbe  
Curved  
Curvo

Coudé court  
Angular short size  
Acodado corto

Coudé long  
Angular long size  
Acodado largo



**J80100**  
15 cm - 6 "

**J80090**  
15 cm - 6 "

**J80080**  
15 cm - 6 "

XIII - Osseux  
XIII - Bone surgery  
XIII - Cirugía ósea

# LANDANGER

Instrument à ménisque - Meniscus instruments - Instrumentation para menisco



LANDANGER

NICOLLET- MUSEUX



**J80120**  
19 cm - 7 <sup>1</sup>/<sub>2</sub> "



**J80130**  
16 cm - 6 <sup>1</sup>/<sub>4</sub> "



# LANDANGER

Instrument à ménisque - Meniscus instruments - Instrumentation para menisco

NICOLLET - KOCHER

BIRCHER



**J80140**  
16 cm - 6 1/4"



**J80150**  
20 cm - 8"



Ciseau à ménisque  
Meniscus scissors  
Tijeras para menisco

**J80170**  
18 cm - 7"

**XIII - 109**

# LANDANGER

Instrument à ménisque - Meniscus instruments - Instrumentation para menisco

3/4

## SMILLIE-TRILLAT

Cylindre seul  
Cylinder alone  
Cilindro sólo

**J80190**



Ø 4 mm

**J80180**

25 cm - 10 "

Passe-fil  
Wire guide  
Guia hilo

Ø 2,5 mm



**J80200**

30 cm - 11 <sup>3</sup>/<sub>4</sub> "

**XIII - 110**

# LANDANGER

## Instrumentation de Trillat - Trillat's instrumentation - Instrumentación de Trillat

### TRILLAT

Levier pour épaule  
Lever for shoulder  
Elevador para hombro



**J80210**  
24 cm - 9 1/2"

### OLLIER

Poinçon  
Point  
Punzón



**J80230**  
20 cm - 8"

**J80220**  
18 cm - 7"



# LANDANGER

## Instrumentation de Trillat - Trillat's instrumentation - Instrumentación de Trillat



### TRILLAT

6 mm	<b>J80270</b>
8 mm	<b>J80280</b>
10 mm	<b>J80290</b>
12 mm	<b>J80300</b>
14 mm	<b>J80305</b>

Ø 8 mm

Crochet  
Hook  
Ganchura

Explorateur  
Hook probe  
Explorador

Rugine  
Raspatory  
Raspador

6 mm



**J80270**  
22 cm - 8 <sup>3</sup>/<sub>4</sub>''



**J80370**  
26 cm - 10 <sup>1</sup>/<sub>4</sub>''



**J80390**  
24 cm - 9 <sup>1</sup>/<sub>2</sub>''



**J80420**  
24 cm - 9 <sup>1</sup>/<sub>2</sub>''

# LANDANGER

Instrumentation pour genou - Instrumentation for knee - Instrumentación para rodilla

 1/3



Modèle simple  
Simple model  
Modelo simple

**J80400**

Modèle double  
Double model  
Modelo doble

**J80410 = J80400 + J80405**

Pièce complémentaire pour former le support double  
Complementary piece to form the double support  
Pieza complementaria para formar el soporte doble



**J80405**

**J80400**

# LANDANGER

Instrumentation pour genou - Instrumentation for knee - Instrumentación para rodilla



## MURPHY



17 mm

Concave  
Concave  
Concavo

J80445

J80440

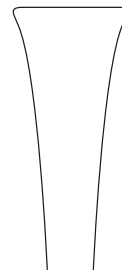

17 mm

Droite  
Straight  
Recta

J80435

J80430



17 mm

Convexe  
Convex  
Convexo

J80455

J80450

22 cm - 8 3/4 "

28 cm - 11 "

**J80445**

22 cm - 8 3/4 "

**XIII - 114**

# LANDANGER

Instrumentation pour genou - Instrumentation for knee - Instrumentación para rodilla



## LEMAIRE

Aiguille pour rotule  
Needle for kneecap  
Aguja para rotula



**J80495**  
19 cm - 7 1/2"

Rifloir  
Rasp  
Lima



**J80500**  
20 cm - 8"





Forets - Drills - Brocas

Tarauts - Taps - Terrajas

Mandrins - Chucks - Mandriles

Fraises, jauges - reamers, gauges - Tornillos



P 1



P 2



P 3

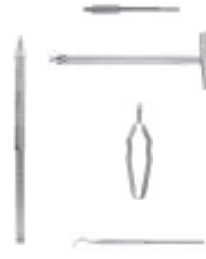

P 4

Tournevis - Screw driver - Destornilladores

Guide mèches - Drills guide - Guías de brocas

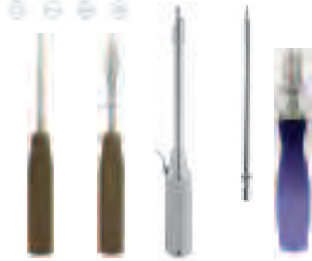

P 5

P 6

P 6

P 7



P 8 - P 10

P 8

P 9 - P 10

P 9

Instrumentation pour plaques - Instruments for plates - Instrumentación para placas



P 11 - P 13



P 11



P 11



P 12 - P 13



P 17



P 17

Instrumentation de cambrage - Instruments for bending - Instrumentación para doblar

Burin - Chisel - Cincel



P 14



P 15



P 15



P 15



P 16



P 16



P 18

Pinces spécifiques - Specific forceps - Pinzas específicas

Pinces multiservices - Multiservices forceps - Pinzas multiservicios

LAMBOTTE

HERCULES



P 19



P 19



P 19



P 19



P 20



P 21



P 21



P 21



P 21



P 22

Pinces à fils métalliques - Wire pliers - Pinzas de alambre

Pinces à couper le fil - Wire cutting pliers - Alicates para cortar alambre



P 23 P 23 P 24



P 25 P 25 P 26 P 27 P 28 - P 29 P 30

Perforateurs - Drills - Perforadores

LUCAS-CHAMPONNIERE NELATON

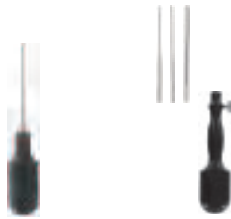

P 31 P 31

Alésoirs - Reamers - Brocas

AESCULAP HUDSON



P 32 P 32 P 33

Enclouage IM - IM nails - Clavos IM



P 34 P 35 P 35 P 36 P 36

Clous RUSH - RUSH pins - Clavos RUSH



P 37 P 37 P 37

Clous élastiques - Flexible nails - Clavos flexibles



P 38 P 39 P 40

Enclouage - Nails - Clavos

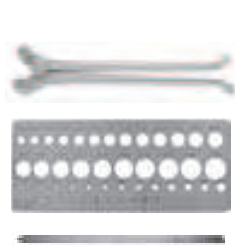

P 41

Vis perforées - Cannulated screw - Tornillos canulados



P 42 P 43 P 44 P 45

Agrafes épiphysaires - Epiphyseal staples - Grapas para epifisis



P 46 P 46 P 46

Agrafes - Staples - Grapas



P 47

Cerclage - Cerclage - Cerclage



P 48 P 48 P 48

# LANDANGER

## Forets - Drills - Brocas



Embase cylindrique - Cylindric neck sleeve - Apoyo cilíndrico

Ø mm	Longueur totale - Total length - Largo total								
	45 mm	70 mm	85 mm	95 mm	120 mm	130 mm	145 mm	156 mm	180 mm
1,1	J61011								
1,4			J61014						
1,5		J61015							
2,0			J61020						
2,5				J61025					
2,7			J61027						
3,0							J61030		
3,2						J61032			J61132
3,5				J61036			J61035		J61135
4,0								J61040	J61140
4,5					J61045				J61145
5,0								J61050	J61150
6,5						J61065			J61165

Verrouillage rapide AO - Quick locking system AO - Bloqueo rápido AO

Ø mm	Longueur totale - Total length - Largo total								
	45 mm	60 mm	85 mm	100 mm	110 mm	130 mm	145 mm	156 mm	195 mm
1,1		J61211							
1,4									
1,5			J61215						
2,0				J61220					
2,5					J61225				
2,7				J61227					
3,0							J61230		
3,2							J61232		J61332
3,5					J61236		J61235		J61335
4,0							J61240		J61340
4,5							J61245		J61345
5,0							J61250		J61350
6,5									J61365

# LANDANGER

## Tarauds - Taps - Terrajas



Poignée en T  
T handle  
Mango T

Ø

Pitch

Verrouillage rapide AO  
Quick locking system AO  
Bloqueo rápido AO

-	1,5 mm		<b>M00470</b>
-	2,0 mm		<b>M00471</b>
<b>M00460</b>	2,7 mm		<b>M00472</b>
<b>M00461</b>	3,5 mm	1,25	<b>M00473</b>
<b>M00462</b>	3,5 mm	1,75	<b>M00474</b>
<b>M004625</b>	4,0 mm	1,75	<b>M00475</b>
-	4,5 mm court		<b>M00476</b>
<b>M00463</b>	4,5 mm long		<b>M00477</b>
<b>M00464</b>	6,5 mm		<b>M00478</b>



**M00462**  
Ø 3,5 mm  
16 cm - 6 1/4 "



**M00473**  
Ø 3,5 mm  
11 cm - 4 1/4 "

# LANDANGER

## Mandrins - Chucks - Mandriles



## JACOB

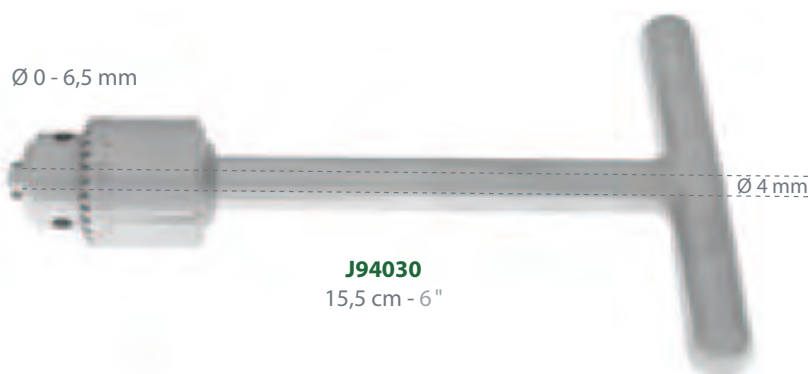

Mandrin autobloquant universel en T  
Universal self-blocked chuck with T handle  
Mandril autoblocante universal con mango T



# LANDANGER

## Instrumentation pour visserie : fraises et jagues - Instruments for screw : reamers and gauges - Instrumentación para tornillos



Pour mini vis Ø 1,5 - 2,0 mm  
For mini screw Ø 1,5 - 2,0 mm  
Para mini tornillos Ø 1,5 - 2,0 mm



**M00490**

Pour vis Ø 2,7 - 3,5 - 4,0 mm  
For screw Ø 2,7 - 3,5 - 4,0 mm  
Para tornillos Ø 2,7 - 3,5 - 4,0 mm



**M00491**

Pince autoserrante  
Self holding forceps  
Pinza autofijadora



**M03060**  
8 cm - 3 "

Pour vis malléole Ø 4,5 mm  
For malleolar screw Ø 4,5 mm  
Para tornillo de maleolo Ø 4,5 mm



**M00492**

Pour vis Ø 4,5 - 6,5 mm  
For screw Ø 4,5 - 6,5 mm  
Para tornillos Ø 4,5 - 6,5 mm



**M00510**

Pour vis Ø 4,5 - 6,5 mm  
For screw Ø 4,5 - 6,5 mm  
Para tornillos Ø 4,5 - 6,5 mm

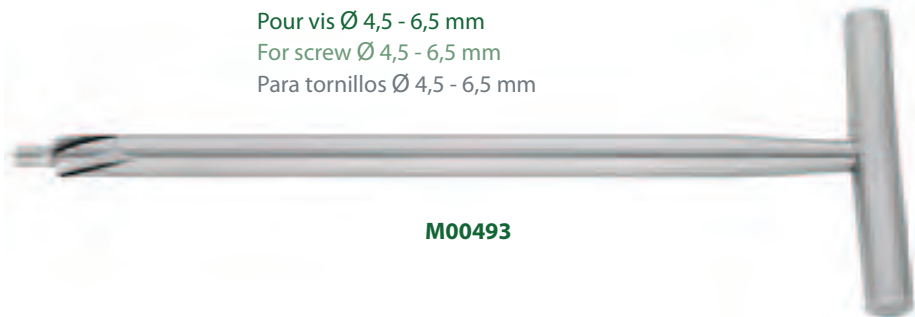

**M00493**



Jauge de profondeur pour vis  
Depth gauge for screw  
Medidor de profundidad para tornillos



Pour vis  
For screw  
Para tornillos

**M03024**

Ø 1,5 - 2,0 mm

**M03020**

Ø 2,7 - 3,5 - 4,0 mm

**M03022**

Ø 4,5 - 6,5 mm

**M03024**

Crochet pour tête de vis  
Hook for screw head  
Gancho para cabeza de tornillos



**M02200**

**XIV - 4**



Tournevis pour vis à tête hexagonale  
Screw driver for hexagonal head  
Destornillador para tornillos con cabeza hexagonal



**M01122**  
20 cm - 8 "

Pour vis - For screw - Para tornillos

1,5 mm	<b>M01120</b>	Ø 1,5 - 2,0 mm
2,5 mm	<b>M01122</b>	Ø 2,7 - 3,5 - 4,0 mm
3,5 mm	<b>M01124</b>	Ø 4,5 - 6,5 mm



Tournevis de Philips  
Screw driver for Philips head  
Destornillador para cabeza Philips



**M01126**  
20 cm - 8 "



Tournevis pour vis à tête fendue  
Screw driver for single head  
Destornillador para cabeza simple



**M01128**  
20 cm - 8 "



Tournevis pour vis tête en croix  
Screw driver for slotted head  
Destornillador para cabeza cruz



**M01130**  
20 cm - 8 "

# LANDANGER

## Tournevis - Screw driver - Destornillador

1/1



Tournevis pour vis à tête hexagonale  
Screw driver for hexagonal head  
Destornillador para tornillos con cabeza hexagonal



Préhenseur seul 2,5 mm  
Holding sleeve only 2,5 mm  
Pinza de sujeción sólo 2,5 mm

**M01160**  
2,5 mm  
20 cm - 8 "

Pour vis  
For screw  
Para tornillos  
Ø 2,7 - 3,5 - 4,0 mm



**M01170**



Préhenseur seul 1,5 mm  
Holding sleeve only 1,5mm  
Pinza de sujeción sólo 1,5 mm

**M01140**  
1,5 mm  
18 cm - 7 "

Pour vis  
For screw  
Para tornillos  
Ø 1,5 - 2,0 mm



**M01150**



1,5 mm

**M01175**



2,5 mm

AO

**M01176**



3,5 mm

AO

**M01177**



Poignée  
Handle  
Mango

Page XIV-3

4/5

## WILLIAMS



**M01138**  
23 cm - 9 "



**M01132**



**M01134**



**M01136**



**M01138**  
3,5 mm

**XIV - 6**



# LANDANGER

## Tournevis - Screw driver - Destornillador



Manche pour tournevis - encliquetage cylindrique  
Handle for screw driver - cylindric locking system  
Mango para destornillador - bloqueo cilindrico



**M01220**  
18 cm - 7 "



Tournevis 2,5 mm  
Screw driver 2,5 mm  
Destornillador 2,5 mm



**M01230**  
17 cm - 6 3/4 "

Tournevis 3,5 mm  
Screw driver 3,5 mm  
Destornillador 3,5 mm



**M01235**  
17 cm - 6 3/4 "



Tournevis Philips  
Screw driver Philips  
Destornillador Philips

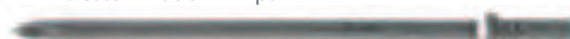

**M01240**  
17 cm - 6 3/4 "

Petit tournevis de Philips  
Screw driver Philips head small  
Destornillador Philips pequeño

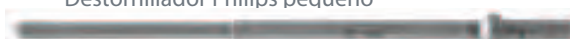

**M01241**  
17 cm - 6 3/4 "

Tournevis à tête fendue  
Screw driver for single head  
Destornillador cabeza simple



**M01200**  
17 cm - 6 3/4 "

Tournevis à tête en croix  
Screw driver for slotted head  
Destornillador para cabeza cruz

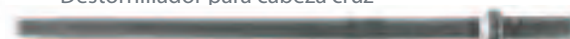

**M01210**  
17 cm - 6 3/4 "

# LANDANGER

## Guide mèches - Drills guide - Guías de brocas

1/1



Ø 1,1 mm  
Ø 1,5 mm

**M03380**  
**M03382**

Ø 1,5 mm  
Ø 2,0 mm



Ø 2,7 mm  
Ø 3,5 mm

**M03391**  
**M03390**

Ø 2,0 mm  
Ø 2,5 mm



Ø 2,7 mm

**M03393**

Ø 1,0 mm



Ø 2,0 mm

**M03381**

Ø 2,0 mm



Guide mèche pointu Ø 6,5 mm  
Pointed drill guide Ø 6,5 mm  
Guía de brocas agudo Ø 6,5 mm

**M03400**  
16 cm - 6 1/4 "

**M03392**  
Ø 3,5 mm

**XIV - 8**

# LANDANGER

## Guide mèches - Drills guide - Guías de brocas

1/1



Guide pour taraud  
Tap guide  
Guía de terraja

**M03410**  
Ø 4,5 mm - 50 mm



Guide meche  
Drill guide  
Guía de broca

**M03420**

Ø 3,2 mm - 40 mm

**M03420**

Ø 3,2 mm - 60 mm

**M03422**

2/3

Guide mèche pour position neutre et de tension  
Neutral and for tension drill guide  
Guía de broca neutral y para tensión



**M03433**

Douille de centrage  
Insert drill sleeve  
Casquillo dentado



**M03436**

Mèche  
Drill  
Broca

Vis  
Screw  
Tornillo

Ø 1,5 mm Ø 2,0 mm

**M03430**

Ø 2,0 mm Ø 2,7 mm

**M03431**

Ø 2,5 mm Ø 3,5 mm

**M03432**

Ø 3,2 mm Ø 4,5 mm

**M03433**

Ø 3,2 mm Ø 4,5 mm 60 mm

**M03435**

Douille  
Insert  
Casquillo

Mèche  
Drill  
Broca

Ø 2,7 mm Ø 2,0 mm

**M03436**

Ø 3,5 mm Ø 2,5 mm

**M03437**

Ø 4,5 mm Ø 3,2 mm

**M03438**

# LANDANGER

Guide mèches - Drills guide - Guías de brocas

1/1



XIV - 10

# LANDANGER

## Instrumentation pour plaques - Instruments for plates - Instrumentación para placas

2/3

Gabarit de forage triple 130° - Ø 3,2 mm  
Triple drill guide angle 130° - Ø 3,2 mm  
Guía de broca triple 130° - Ø 3,2 mm



**M02215**

Plaque repère angle ajustable  
pour ciseaux conducteurs  
Chisel guide with adjustable angle  
Controlador de angulo



**M02235**

Marteau diapason  
Slotted hammer  
Martillo diapason



**M02220**

26 cm - 10<sup>1</sup>/<sub>4</sub> "

Impacteur  
Impactor  
Impactor



**M02130**

20,5 cm - 8 "

Impacteur extracteur  
Impactor extractor  
Portaplaques y extractor

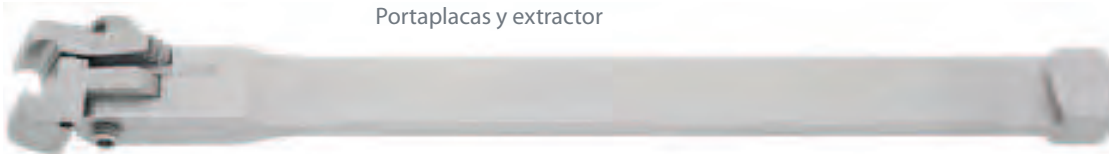

**M02140**

Ciseau conducteur pour plaque de hanche profil "U"  
Graduated seating chisel "U" shaped  
Escoplo - guía graduado perfil "U"



Adultes - Adults - Adultos

**M02230**

16 mm  
25 cm - 10 "

# LANDANGER

## Instrumentation pour plaques - Instruments for plates - Instrumentación para placas

1/1

Viseur pour plaques condyliennes  
Condylar positioning plate  
Plantilla para placas condileas



Etalon d'angle  
Positioning plate  
Patron de angulo



# LANDANGER

## Instrumentation pour plaques - Instruments for plates - Instrumentación para placas

1/1

2/3

Impacteur de plaques de hanches pour enfants et adolescents  
 Introducer extractor for angled plates - adolescents and children  
 Porta placas y extractor para placas anguladas adolescentes y niños



**M02150**

2/3

Ciseau conducteur pour plaques coudées en "L"  
 Graduated seating chisel for plates "L" shaped  
 Escoplo-guía graduado para placas perfil "L"



Adolescents - Teenagers - Adolescentes

**M02240**

13 mm  
 25 cm - 10 "

Enfants - Children - Niños

**M02241**

11 mm  
 25 cm - 10 "

Etalon d'angle  
 Positioning plate  
 Patron de angulo

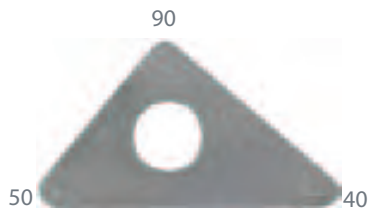

**M03034**



**M03035**



**M03036**



**M03037**

# LANDANGER

## Instrumentation de cambrage - Instruments for bending - Instrumentación para doblar



Fer à cintrer les mini plaques  
Plate bender for mini plates  
Llave para doblar placas mini



1,8 mm

**M01250**

12 cm - 4 <sup>3</sup>/<sub>4</sub> "

Fer à cintrer les plaques de reconstruction  
Plate bender for reconstruction plates  
Llave para doblar placas de reconstrucción



4,0 mm / 2,4 mm

**M01251**

14,5 cm - 5 <sup>3</sup>/<sub>4</sub> "



**M01252**

14,5 cm - 5 <sup>3</sup>/<sub>4</sub> "

2,4 mm / 4,0 mm

4,5 mm



Fer à cintrer les plaques standards  
Plate bender for standard plates  
Llave para doblar placas rectas



6,0 mm

**M01253**

25,5 cm - 5 <sup>3</sup>/<sub>4</sub> "

Trous  
Holes  
Agujeros

Gabarit de cintrage  
Template bending  
Modelo para doblar

**M01050**

5

**M01051**

7

**M01052**

9

**M03520**

7

Petite plaque - Small plate - placa pequeña

**M03530**

9

Petite plaque - Small plate - placa pequeña



**M01050**

12 x 84 mm



# LANDANGER

## Instrumentation de cambrage - Instruments for bending - Instrumentación para doblar

3/4

Pince pour cintrer les plaques  
Plate bending pliers  
Alicates para doblar placas



**M03110**  
15 cm - 6 "



7 mm



**M03120**  
14 cm - 5 1/2 "



**M03125**  
20 cm - 8 "

Plaques  
Plates  
Placas

1,0 - 2,0 mm

**M03125**

2,7 - 3,5 mm

**M03126**

**XIV - 15**

# LANDANGER

Instrumentation de cambrage - Instruments for bending - Instrumentación para doblar

2/3

Pince pour cintrer les plaques droites 4 et 6 mm  
Plate bender for straight plates 4 and 6 mm  
Pinza para doblar placas rectas 4 y 6 mm



**M03130**  
25,5 cm - 10 "

Presse pour cintrer les plaques  
Bending press for plates  
Prensa para doblar placas

1/3



**M03135**  
42 cm - 16 1/2 "

# LANDANGER

## Instrumentation pour plaques - Instruments for plates - Instrumentación para placas

Guide mèche pour tendeur 8 et 16 mm  
 Drill guide for tension device 8 and 6 mm  
 Guía de perforación para tensor 8 y 6 mm

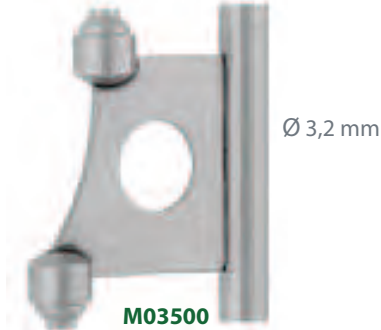

Tendeur de plaque course 8 mm  
 Tension device for plate - 8 mm span  
 Tensor para placas curso 8 mm



1/1

Clé à cardan 11 mm  
 Socket wrench 11 mm  
 Llave cardan 11 mm



Clé mixte de 11 mm  
 Open end wrench 11 mm  
 Llave figa 11 mm



2/3

# LANDANGER

## Burin à os - Osseous chisel - Cincel para huesos



Manche de burin  
Bone chisel handle  
Mango de cincel



**M02270**

18,5 cm - 7 1/4 "

Lame de burin  
Bone chisel blade  
Hoja de cincel



**M02272**

80 mm

5 mm	<b>M02274</b>
10 mm	<b>M02271</b>
16 mm	<b>M02272</b>
25 mm	<b>M02273</b>

Clé pour manche de burin  
Wrench for bone chisel  
Llave para mandril



**M02275**

85 mm

# LANDANGER

## Pinces spécifiques - Specific forceps - Pinzas específicas

1/1

Pince pour mini plaque  
Holding forceps for mini plates  
Pinza para placa mini

**M03170**  
13,5 cm - 5 1/4 "

### LAMBOTTE

Porte-vis ou plaque  
Screw Holder  
Porta-tornillos o placa

**J756900**  
16 cm - 6 1/4 "

**J757900**  
13 cm - 5 "

Pince tire-broches  
Wire seizing forceps  
Pinza para coger agujas

**J758000**  
18 cm - 7 "

Tord-broches  
Iron for pins  
Tubo para curvar agujas

Ø max  
2,0 mm

Ø max  
3,2 mm

**M03600**  
15 cm - 6 "

**XIV - 19**

# LANDANGER

Pinces spécifiques - Specific forceps - Pinzas específicas

1/1



## HERCULES

Extraction  
Extraction  
Extracción



3 mm

**J758430**  
18 cm - 7 "



6 mm

**J758431**  
18 cm - 7 "

# LANDANGER

Pinces multiservices - Multiservices forceps - Pinzas multiservicios

 1/1

Pince universelle  
Universal forceps  
Pinza universal

Ø max. : 1,5 mm

**J757410**  
20 cm - 8 "

Mors parallèles  
Parallel jaws  
Bocas paralelas

**J759030**  
17 cm - 6 3/4 "

**J759040**  
18 cm - 7 "

 3/4

**J759050**  
25 cm - 10 "

# LANDANGER

## Pinces multiservices - Multiservices forceps - Pinzas multiservicios



Mors courts  
Short jaws  
Bocas cortas  
13 cm - 5 1/4 "

Mors longs  
Long jaws  
Bocas largas  
14,5 cm - 5 3/4 "

Mors taillés  
Serrated jaws  
Bocas estriadas

**B713290**

**B713250**

Mors taillés avec ressort  
Serrated jaws with spring  
Bocas estriadas con resorte

**B713310**

**B713270**

Mors lisses  
Smooth jaws  
Bocas lisas

**B713280**

**B713240**

Mors lisses avec ressort  
Smooth jaws with spring  
Bocas lisas con resorte

**B713300**

**B713260**



**B713250**  
14,5 cm - 5 3/4 "



**B713270**  
14,5 cm - 5 3/4 "



# LANDANGER

Pinces à fils métalliques - Wire pliers - Pinzas de alambre

1/1

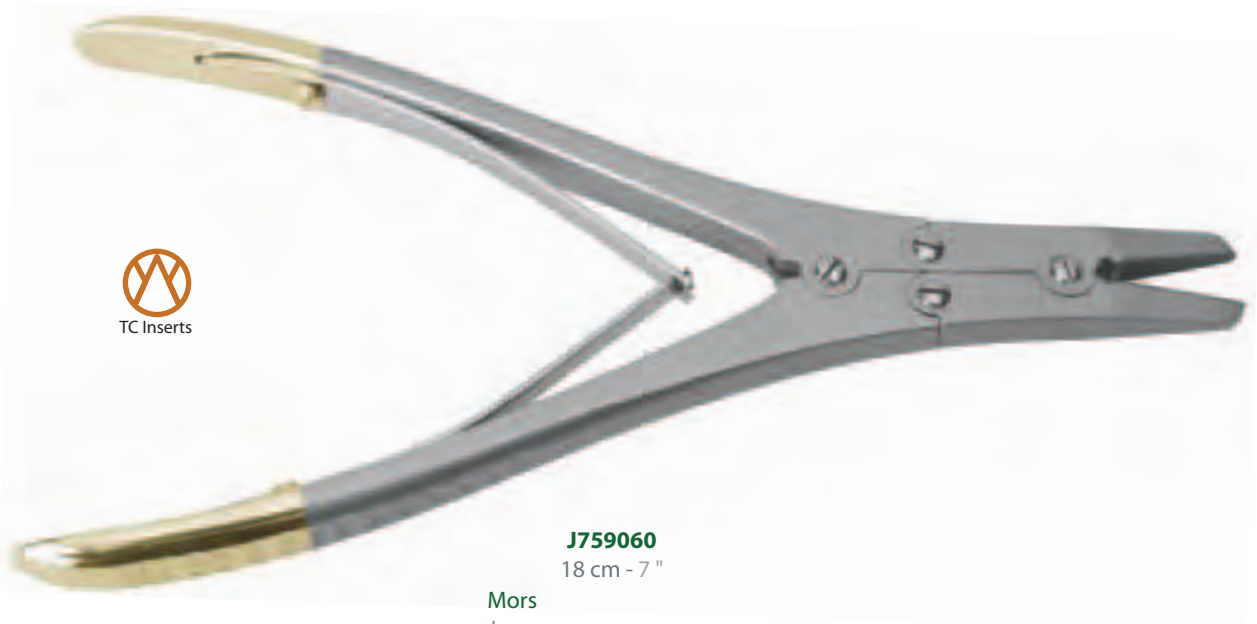

**J759060**  
18 cm - 7 "

Mors  
Jaws  
Bocas

3 mm  
4 mm  
6 mm

J759060

J759061

J759062

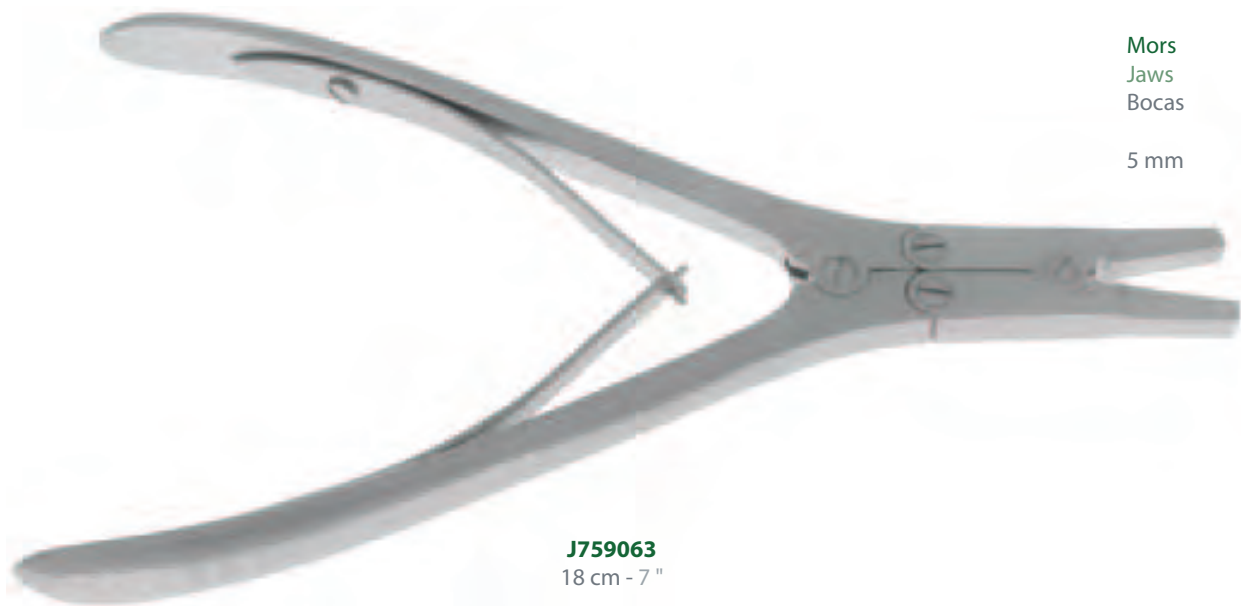

**J759063**  
18 cm - 7 "

Mors  
Jaws  
Bocas

5 mm

# LANDANGER

Pinces à fils métalliques - Wire pliers - Pinzas de alambre



14 cm - 5 1/2 "

**J759100**

17 cm - 6 3/4 "

**J759105**

17 cm - 6 3/4 "

**J759110**

19 cm - 7 1/2 "

**J759115**



**J759100**  
14 cm - 5 1/2 "



**J759105**  
17 cm - 6 3/4 "



**J759110**  
17 cm - 6 3/4 "



**J759115**  
19 cm - 7 1/2 "



**J759110**  
17 cm - 6 3/4 "

# LANDANGER

Pinces à couper le fil - Wire cutting pliers - Alicates para cortar alambre



Ø max : 1,5 mm

**J757500**  
18,5 cm - 7 1/4 "



Ø max : 1,5 mm

**J757510**  
15 cm - 6 "



Ø max : 2,2 mm

**J757520**  
22 cm - 8 3/4 "

# LANDANGER

Pinces à couper le fil - Wire cutting pliers - Alicates para cortar alambre

3/4



Ø max : 1,7 mm

**J758200**  
18 cm - 7 "



Ø max : 2,5 mm

**J758300**  
22 cm - 8 3/4 "

**XIV - 26**

# LANDANGER

Pinces à couper le fil - Wire cutting pliers - Alicates para cortar alambre



**J758050**  
47 cm - 18 1/2 "

Ø max. : 5 mm



**J758060**

# LANDANGER

Pinces à couper le fil - Wire cutting pliers - Alicates para cortar alambre

1/1



## HERCULES

Ø max : 3,0 mm



Mors tungstène de rechange (paire)  
Tungsten jaw for exchange (pair)  
Boca de tungsteno de recambio (par)



**J758420 pour/for/para J758400**  
**J758423 pour/for/para J758403**

Mors caoutchouc de rechange  
Rubber jaws for exchange  
Bocas caucho de recambio



**J758410**

**J758400**

Ø max : 3,0 mm  
23 cm - 9 "

**J758403**

Ø max : 3,5 mm  
28 cm - 11 "

**XIV - 28**

# LANDANGER

Pinces à couper le fil - Wire cutting pliers - Alicates para cortar alambre



## HERCULES

Mors tungstène de rechange (paire)  
Tungsten jaw for exchange (pair)  
Boca de tungsteno de recambio (par)

Ø max : 2,2 mm



J758421



J758402 droitier  
18 cm - 7 "



J758401 gaucher  
18 cm - 7 "

# LANDANGER

Pinces à couper le fil - Wire cutting pliers - Alicates para cortar alambre



## HERCULES

Ø max : 2,0 mm

Coupe câble  
Cable cut  
Corta cables



**J758405**  
18 cm - 7 "

Ø max : 1,6 mm

Coupe distale et latérale  
Distal and lateral cut  
Corta distal y lateral



**J758404**  
18 cm - 7 "

Mors tungstène de rechange (paire)  
Tungsten jaw for exchange (pair)  
Boca de tungsteno de recambio (par)

**J758425**

Mors tungstène de rechange avec protection caoutchouc (paire)  
Tungsten jaw for exchange with rubber protection (pair)  
Boca de tungsteno de recambio con protección de caucho (par)

**J758424**



# LANDANGER

Instrumentation osseuse - perforateurs - Osseos instrumentation - drills - Instrumentación osea - perforadores



## LUCAS-CHAMPIONNIERE

## NELATON

Fixe  
Fixed  
Fijo



**J94150**  
17 cm - 6 <sup>3</sup>/<sub>4</sub> "



Foret seul  
Drill only  
Broca sólo

∅ 9,5 cm - 3 <sup>3</sup>/<sub>4</sub> "

2 mm	<b>J94170</b>
3 mm	<b>J94180</b>
4 mm	<b>J94190</b>



Perforateur complet avec 3 forets  
Complete perforator with 3 drills  
Perforador completo con 3 bocas

**J94160**

**J94160**  
12 cm - 4 <sup>3</sup>/<sub>4</sub> "

**XIV - 31**

# LANDANGER

Alésoirs flexibles médullaires - Flexible medullary reamers - Brocas flexibles para la medula



## AESCLAP

Ø mm		L mm
6,0 mm	M00100	350
6,5 mm	M00101	350
7,0 mm	M00102	350
7,5 mm	M00103	350
8,0 mm	M00104	480
8,5 mm	M00105	480
9,0 mm	M00106	480
9,5 mm	M00107	480
10,0 mm	M00108	480
10,5 mm	M00109	480
11,0 mm	M00110	480
11,5 mm	M00111	480
12,0 mm	M00112	480
12,5 mm	M00113	480
13,0 mm	M00114	480
13,5 mm	M00115	480
14,0 mm	M00116	480
14,5 mm	M00117	480
15,0 mm	M00118	480
15,5 mm	M00119	480
16,0 mm	M00120	480
16,5 mm	M00121	480
17,0 mm	M00122	480
17,5 mm	M00123	480
18,0 mm	M00124	480



**M00116**  
Ø 14 mm

## HUDSON

Ø mm		L mm
6,0 mm	M00010	350
6,5 mm	M00011	350
7,0 mm	M00012	350
7,5 mm	M00013	350
8,0 mm	M00014	480
8,5 mm	M00015	480
9,0 mm	M00016	480
9,5 mm	M00017	480
10,0 mm	M00018	480
10,5 mm	M00019	480
11,0 mm	M00020	480
11,5 mm	M00021	480
12,0 mm	M00022	480
12,5 mm	M00023	480
13,0 mm	M00024	480
13,5 mm	M00025	480
14,0 mm	M00026	480
14,5 mm	M00027	480
15,0 mm	M00028	480
15,5 mm	M00029	480
16,0 mm	M00030	480
16,5 mm	M00031	480
17,0 mm	M00032	480
17,5 mm	M00033	480
18,0 mm	M00034	480



**M00010**  
Ø 6 mm

# LANDANGER

Alésoirs médullaires rigides - Rigid medulary reamers - Brocas rigidas para la medula



Poignée en T  
Handle T  
Mango T



Ø	
6,0 mm	M00200
7,0 mm	M00201
8,0 mm	M00202
9,0 mm	M00203
10 mm	M00204
11 mm	M00205
12 mm	M00206
13 mm	M00207
14 mm	M00208
15 mm	M00209
16 mm	M00210
17 mm	M00211
18 mm	M00212
19 mm	M00213
20 mm	M00214

**M00207**  
Ø 13 mm  
52 cm - 20 1/2 "

# LANDANGER

## Guide pour alésoirs et clous IM - Guide for reamers and nails IM - Guía para brocas y clavos IM



Pour clous IM  
For IM nails  
Para clavos IM



**M03200**

60 cm - 23 3/4 "

Ø 3,0 mm **M03200**

Ø 3,5 mm **M03201**

Ø 4,0 mm **M03202**

Ø 5,0 mm **M03203**

Droit  
Straight  
Recto



**M03240**

Ø 2,4 mm  
90 cm - 35 1/2 "

**M03241**

Ø 3,0 mm  
90 cm - 35 1/2 "

Courbe  
Curved  
Curvo



**M03291**

Ø 2,4 mm  
90 cm - 35 1/2 "

**M03290**

Ø 3,0 mm  
90 cm - 35 1/2 "

Pour alésoir flexible  
For flexible reamer  
Para broca flexible



**M03250**

Ø 2,0 mm  
90 cm - 35 1/2 "

Ø 3,0 mm

**M03280**

Ø 3,0 mm  
90 cm - 35 1/2 "

Ø 4,0 mm

# LANDANGER

## Instrumentation pour enclouage IM - Instruments for IM nails - Instrumentación para clavos IM

 2/3



Perforateur initial  
Initial drill  
Perforador inicial

**J94020**  
27 cm - 10 <sup>3</sup>/<sub>4</sub> "



Alésoir  
Reamer  
Broca

**M00250**  
27 cm - 10 <sup>3</sup>/<sub>4</sub> "



Marteau diapason  
Slotted hammer  
Martillo diapason

**M02170**  
27 cm - 10 <sup>3</sup>/<sub>4</sub> "



**M02190**  
26 cm - 10 <sup>1</sup>/<sub>4</sub> "

**XIV - 35**

# LANDANGER

## Instrumentation pour enclouage IM - Instruments for IM nails - Instrumentación para clavos IM

2/3

Crochet d'extraction  
Extraction hook  
Gancho de extracción

29 cm - 11 1/2 "

M02000

37 cm - 14 1/2 "

M02001

43 cm - 17 "

M02002

51 cm - 20 "

M02003

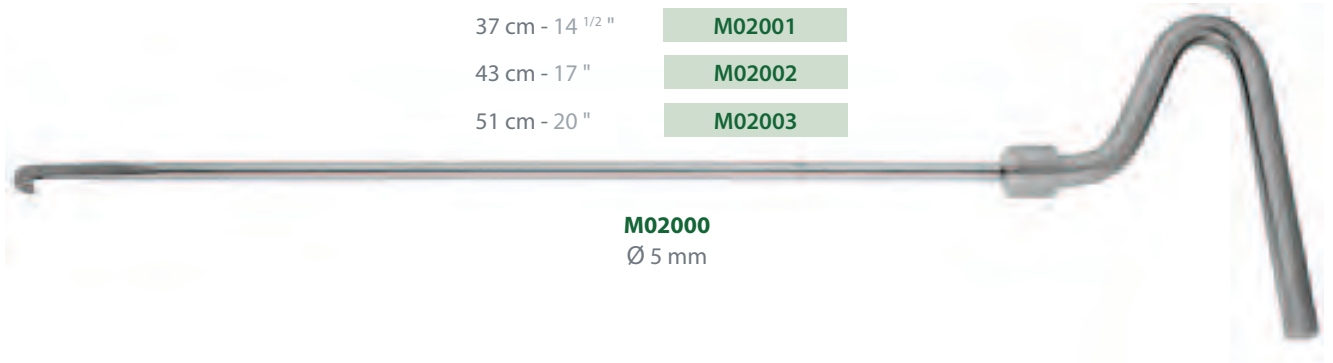

M02000  
Ø 5 mm

Arrache clou à masse coulissante avec 2 crochets  
Nail extractor with 2 hooks - sliding Mallet  
Extractor de clavos con 2 ganchos



M02010  
63 cm - 24 3/4 "

Petit crochet pour arrache clou  
Small hook for nail extractor  
Gancho pequeño para extractor de clavos



M02020  
9 cm - 3 1/2 "

Grand crochet pour arrache clou  
Large hook for nail extractor  
Gancho largo para extractor de clavos



M02021  
9 cm - 3 1/2 "

# LANDANGER

## Instrumentation pour clou RUSH - Instruments for RUSH pins - Instrumentación para clavos RUSH

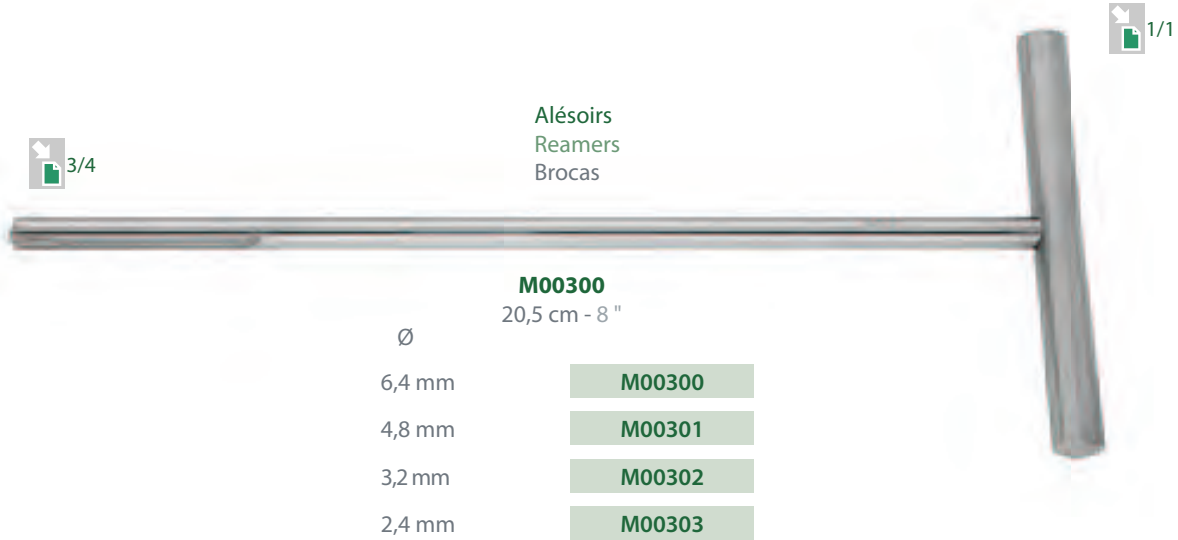

Alésoirs  
Reamers  
Brocas

**M00300**  
20,5 cm - 8 "

Ø	
6,4 mm	<b>M00300</b>
4,8 mm	<b>M00301</b>
3,2 mm	<b>M00302</b>
2,4 mm	<b>M00303</b>

Guide et extracteur  
Driver and extractor  
Conductor y extractor



**M03210**  
19 cm - 7 1/2 "



6,4 x 18 mm

6,4 mm	<b>M03210</b>
4,8 mm	<b>M03211</b>
3,2 mm	<b>M03212</b>
2,4 mm	<b>M03213</b>

Fer à cintrer les clous de RUSH et clous à palette  
Plate bender for RUSH pins and palet nails  
Llave para doblar clavos de RUSH y clavos paleta

Ø 6,7 mm / Ø 5,3 mm

5,0 mm



6,5 mm

**M01000**  
20,5 cm - 8 "

Ø 3,4 mm / Ø 2,7 mm

# LANDANGER

Instrumentation pour clous élastiques - Instrument for flexible nails - Instrumentación para clavos flexibles

1/1

Pousse clou  
Nail inserter  
Impactor



**M03220**  
17,5 cm - 7 "



3,0 x 7,3 mm

Guide clou  
Impactor guide  
Mango impactor - conductor



**M02030**  
20 cm - 8 "



2,7 x 7,0 mm

Impacteur extracteur  
Impactor extractor  
Impactor extractor

3/4



**M02040**  
19,5 cm - 7 3/4 "

Extracteur  
Extractor hook  
Gancho extractor

1/2



**M02050**  
39,5 cm - 15 1/2 "

**XIV - 38**



# LANDANGER

## Instrumentation pour clous élastiques - Instrument for flexible nails - Instrumentación para clavos flexibles



Trocart avec guide introduction  
Trocar with sleeve  
Trocar con mandril

**M03320**

120 mm

Ø 6 mm

Ø 8 mm

Pour clous  
For nails  
Para clavos

Ø 1,5 - 3,5 mm

**M03321**

Ø 3,5 - 5,0 mm

**M03320**



Impacteur pour clous élastiques (sans mandrin)  
Impactor for gliding nails (without sleeve)  
Impactor para clavos flexible (sin mandril)

**M02080**

16 cm - 6 1/4 "

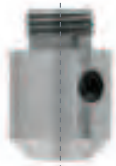

Mandrin de centrage  
Centering sleeve  
Mandril para centrar

**M02092**

Pour clous  
For nails  
Para clavos

Ø 1,5 - 2,0 mm

**M02090**

Ø 2,5 - 3,0 mm

**M02091**

Ø 3,5 - 5,0 mm

**M02092**

# LANDANGER

## Instrumentation pour clous élastiques - Instrument for flexible nails - Instrumentación para clavos flexibles



Pince extractrice  
Extraction forceps  
Pinza de extracción



**XIV - 40**

**M03050**  
22 cm - 8 3/4 "

Impacteur de clous  
Nails impactor  
Impactor de clavos



Ø 3,0 mm



**M02071**  
15,5 cm - 6 "

Pour clous  
For nails  
Para clavos

Ø 1,5 - 2,5 mm

**M02070**

Ø 2,5 - 3,0 mm

**M02071**

Ø 3,5 - 5,0 mm

**M02072**

# LANDANGER

## Instrumentation pour enclouage - Instruments for nails - Instrumentación para clavos

2/3

Pince pour cintrer les clous  
Bending template for nails  
Pinza para contornear los clavos



**M03040**  
29 cm - 11 1/2 "

1/1

Jauge pour alésoirs, clous et vis  
Reamer, nails and screw template  
Medidor para brocas, clavos, tornillos



**M03001**  
180 x 75 mm

1/3

Jauge de profondeur pour clous  
Nail depth gauge  
Medidor de profundidad para clavos



**M03002**

# LANDANGER

## Instrumentation pour vis perforées - Instruments for cannulated screw - Instrumentación para tornillos canulados



Foret perforé  
Drill cannulated  
Broca canulada



**M00383**  
16 cm - 6 1/4 ''  
Ø 5,0 mm

Ø

**M00382** 2,7 mm

**M00411** 3,2 mm

**M00381** 3,5 mm

**M00410** 4,5 mm

**M00383** 5,0 mm

**M004001**

Taraud perforé  
Cannulated tap  
Terraja canulado



**M004001**  
16 cm - 6 1/4 ''  
Ø 3,5 mm

Mandrin perforé  
Cannulated chuck  
Mandril canulado



**M003890**  
9,5 cm - 3 3/4 ''

Ø 2,3 mm

A0  
Ø 4,5 mm

# LANDANGER

## Instrumentation pour vis perforées - Instruments for cannulated screw - Instrumentación para tornillos canulados



Viseur parallèle pour broche guide 2 mm  
Parallel target device for guide pin 2 mm  
Visor paralelo para aguja guía 2 mm



**M03350**

18,5 cm - 7 1/4 "

Broche guide  
Guide pin  
Aguja guía

Broche Pin Aguja	Pour vis For screw Para tornillo	
Ø 1,0 mm	Ø 3,5 mm	<b>M03355</b>
Ø 1,6 mm	Ø 4,5 mm	<b>M03356</b>
Ø 2,0 mm	Ø 7,0 mm	<b>M03357</b>

Douille protectrice  
Tissue protector sleeve  
Casquillo de protección

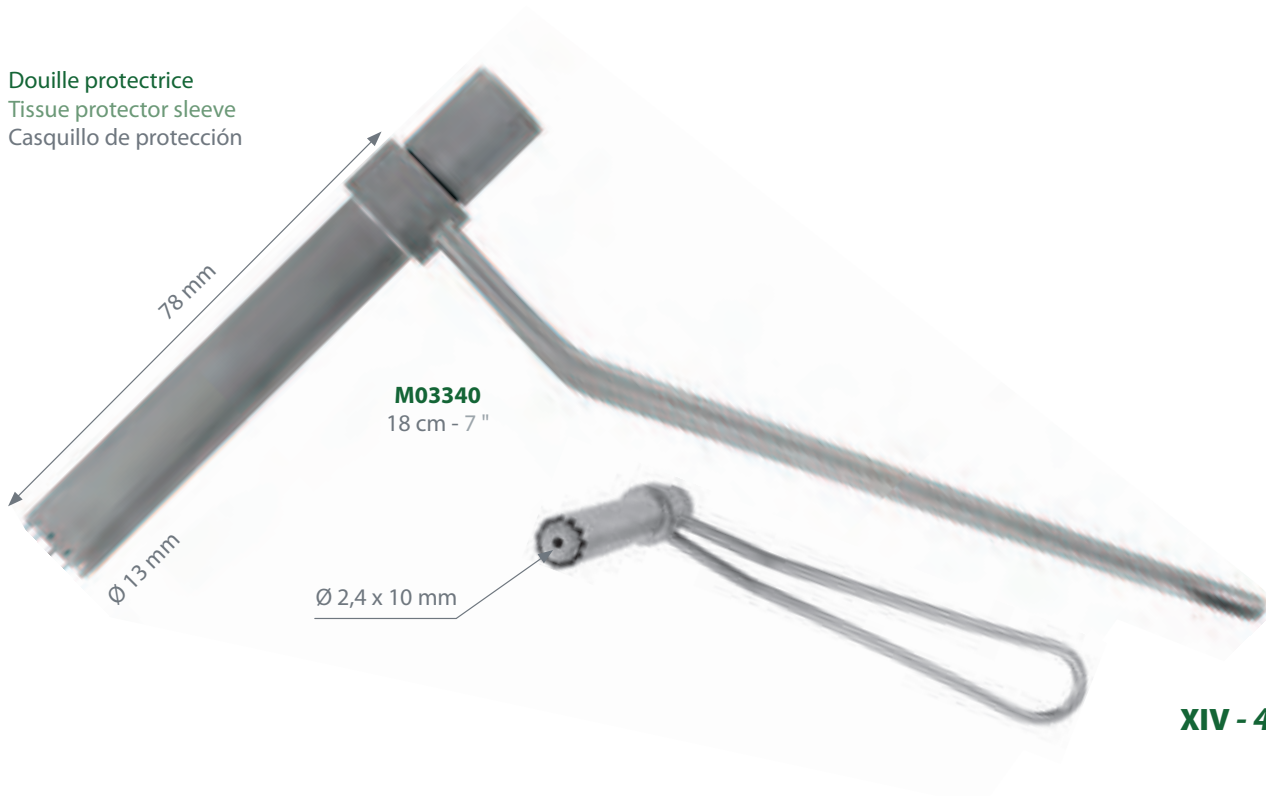

**M03340**

18 cm - 7 "

Ø 2,4 x 10 mm

**XIV - 43**

# LANDANGER

## Instrumentation pour vis perforées - Instruments for cannulated screw - Instrumentación para tornillos canulados



Tournevis pour vis perforées  
Screw driver for cannulated screw  
Atornillador para tornillos canulados



Pour vis Ø 3,5 mm  
For screw Ø 3,5 mm  
Para tornillos Ø 3,5 mm

**M01080**

19,5 cm - 7 <sup>3</sup>/<sub>4</sub> "



Pour vis Ø 4,5 mm  
For screw Ø 4,5 mm  
Para tornillos Ø 4,5 mm

**M01070**

22 cm - 8 <sup>3</sup>/<sub>4</sub> "

Pour vis Ø 7,0 mm  
For screw Ø 7,0 mm  
Para tornillos Ø 7,0 mm

**M01060**

22 cm - 8 <sup>3</sup>/<sub>4</sub> "

# LANDANGER

Instrumentation pour vis perforées - Instruments for cannulated screw - Instrumentación para tornillos canulados



Jauge de longueur directe  
Direct length gauge  
Medidor de largo directe



**M03010**

**Pour vis**  
**For screw**  
**Para tornillos**

Ø 7,0 mm	230 mm	<b>M03010</b>
Ø 4,5 mm	230 mm	<b>M03011</b>
Ø 3,5 mm	210 mm	<b>M03012</b>

Tige de nettoyage  
Canal cleaner  
Hilo para limpiar



**M03360**

23 cm - 9"

2,0 mm	<b>M03360</b>
1,6 mm	<b>M03361</b>
1,2 mm	<b>M03362</b>

# LANDANGER

## Instrumentation pour agrafes épiphysaires - Instruments for epiphyseal staples - Instrumentación para grapas para epifisis



Extracteur à agrafes  
Staples extractor  
Extractor de grapas



**M02100**  
20,5 cm - 8 "

Impacteur à agrafes  
Staples inserter  
Impactor de grapas



**M02110**  
16 cm - 6 1/4 "



Porte agrafes  
Staples driver  
Porta grapas



**M02120**  
16 cm - 6 1/4 "





# LANDANGER

## Instrumentation pour agrafes - Instruments for staples - Instrumentación para grapas



Impacteur  
Impactor  
Impactor



**M02122**  
24,5 cm - 9 <sup>3</sup>/<sub>4</sub> "



Impacteur pour agrafes épiphysaires  
Impactor for epiphyseal staples  
Impactor para grapas para epifisis

**M02124**  
16,5 cm - 6 <sup>1</sup>/<sub>2</sub> "

Impacteur pour agrafes décalées  
Impactor for stepped staples  
Impactor para grapas escalonadas

**M02126**  
16,5 cm - 6 <sup>1</sup>/<sub>2</sub> "

# LANDANGER

## Instrumentation pour cerclage - Instruments for cerclage - Instrumentación para cerclage

2/3



Tendeur de fils  
Wire tightener  
Tensor de alambre

**M03700**  
24,5 cm - 9 <sup>3</sup>/<sub>4</sub> "



Tendeur de fils  
Wire tightener  
Tensor de alambre

**M03710**  
13 cm - 5 <sup>1</sup>/<sub>4</sub> "

Ø 2,3 mm



Guide fil  
Wire passer  
Pasahilos

**M03745**  
22 cm - 8 <sup>3</sup>/<sub>4</sub> "



**M03770**  
28,5 cm - 11 <sup>1</sup>/<sub>4</sub> "

**XIV - 48**

75 mm

40 mm

Marteau à réflexes - Percussion hammers - Martillos a reflejos

BABINSKY VERNON



P 1 P 1

Garrots - Tourniquets - Torniquetes

Garrot plein  
Rubber tourniquet  
Torniquete de caucho



P 2 P 2

Matériel divers - Miscellaneous materials - Materiales varios

LECOUTEUR



P 3 P 3 P 3 P 4

Instrumentation de service - Instrumentation for services - Instrumentación de servicio

MAGILL

NELATON



P 5 P 6 P 6 P 6 P 7 P 8 P 8 P 9

LISTER

MAYO

METZENBAUM

ADSON



P 10 P 10 P 10 P 10 P 11 P 11 P 11 P 11 P 12 P 12 P 12

PEAN

KOCHER

MAYO-HEGAR

CRILE-WOOD

HALSTEAD

LERICHE

BACKHAUS

MURPHY

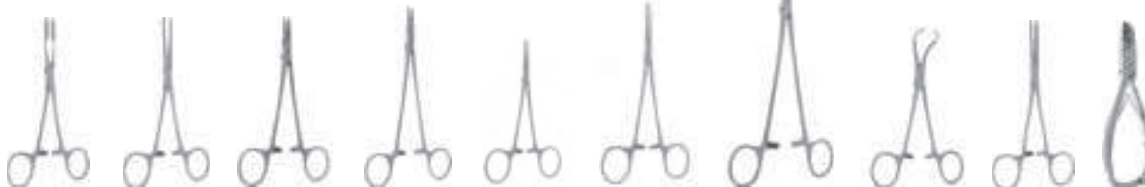

P 12 P 13 P 13 P 13 P 14 P 14 P 15 P 15 P 15 P 15

Instrumentation de service - Instrumentation for services  
Instrumentación de servicio



P 16



P 16

Instruments pour plâtre - Plaster instruments  
Instrumentos para escayolas

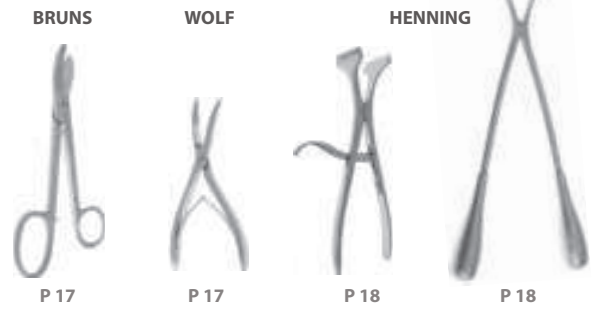

BRUNS

WOLF

HENNING

P 17

P 17

P 18

P 18

Matériel divers - Miscellaneous materials - Materiales varios



P 19

P 20

P 21

P 22

SANTY

YANKAUER

NUBOER

ANDREW  
PYNCHON

AUBERT

P 23

P 23

P 23

P 23

P 23

HÉPARINE

LUER LOCK

MONOD

BORDIER-MEUNIER

Épilation

ULTRA-ASEPT

MAYO

ENEMA

GUYON  
FREUDENBERG



P 24



P 24



P 25



P 25



P 26



P 27



P 28



P 28



P 28

LORTAT-JACOB

LANDANGER

IP SPRAY

LANDAX

SILICON SPRAY

Gomme  
Rubber  
Goma



P 29



P 29



P 30



P 30



P 30



P 30

Divers - Miscellaneous - Diversas

PLESTER FRAZIER WERTHEIMER



P 40

P 40

P 40

XII - O.R.L.  
XII - E.N.T.  
XII - O.R.L.

# LANDANGER

Marteaux à réflexes - Percussion hammers - Martillos a reflejos

BABINSKY

VERNON



A05010

Caoutchouc pour Babinsky  
Rubber for Babinsky  
Caucho para Babinsky



A05020



A05050

# LANDANGER

## Garrots - Tourniquets - Torniquetes

2/3



Garrot plein  
Rubber tourniquet  
Torniquete de caucho

**A20530**

1,8 cm x 75 cm

## ESMARCH

Bande  
Bandage  
Banda



**A20560**

6 cm x 3,50 m



**A20570**

8 cm x 3,50 m



**A20580**

10 cm x 3,50 m

**XV - 2**

# LANDANGER

Matériel divers - Miscellaneous materials - Materiales varios



**ABAISSÉ LANGUE**  
TONGUE DEPRESSOR  
DEPRESOR LINGUAL

## LECOUTEUR



**A300020**  
15,5 cm - 6 1/5 "

26 mm

22 mm

**Coudé pour enfants**  
Angled for children  
Acodado para niños



15 mm

25 mm

**A30010**  
15 cm - 6 "

**Coudé pour adultes**  
Angled for adults  
Acodado para adultos



25 mm

30 mm

**A30020**  
15 cm - 6 "

**En bois, boîte de 100**  
Wood, box of 100  
Madera, caja de 100



**A30040**

**XV - 3**

# LANDANGER

## Matériel divers - Miscellaneous materials - Materiales varios



Acier chromé  
Chrome steel  
Acero cromado

Miroir laryngien  
Laryngeal mirror  
Espejo laringeo

Ø 12 mm **A25003**

Ø 14 mm **A25004**

Ø 16 mm **A25005**

Ø 18 mm **A25006**

Ø 20 mm **A25007**

Ø 22 mm **A25008**

Ø 24 mm **A25009**

Ø 26 mm **A25010**

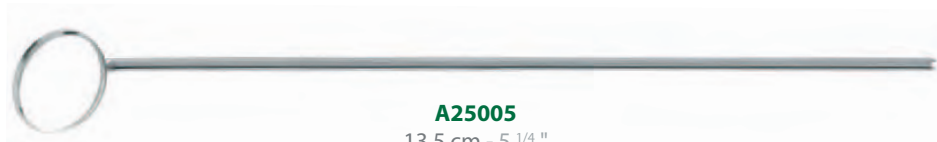

**A25005**  
13,5 cm - 5 1/4 "

Manche pour miroir laryngien  
Handle for laryngeal mirror  
Mango para espejo laringeo



**A25020**  
11 cm - 4 1/4 "



## MAGILL

Pinces à sondes  
Catheter forceps  
Pinzas para sondas



Adultes  
Adults  
Adultos

**A30060**  
22 cm - 8 <sup>3</sup>/<sub>4</sub> "



Enfants  
Children  
Niños

**A30070**  
17 cm - 6 <sup>3</sup>/<sub>4</sub> "



Nourrissons  
Babies  
Niños de pecho

**A30075**  
15 cm - 6 "

# LANDANGER

Instrumentation de service - Instrumentation for services - Instrumentación de servicio



Pinces à ongles - Nail cutters - Pinzas para uñas



**A86010**  
11 cm - 4 1/4 "



**A86020**  
13 cm - 5 "



**A86060**  
14 cm - 5 1/2 "



**A860300**  
13 cm - 5 "

Oblique  
Oblique  
Oblicuo



**A85030**  
14 cm - 5 1/2 "



**A85040**  
15 cm - 6 "

Ciseaux à ongles  
Nail scissors  
Tijeras para uñas

Droit  
Straight  
Recta

Courbe  
Curved  
Curva



**A85090**  
11 cm - 4 1/4 "



**A85100**  
11 cm - 4 1/4 "

**XV - 6**

XV - Divers  
XV - Miscellaneous  
XV - Diversos

# LANDANGER

Instrumentation de service - Instrumentation for services - Instrumentación de servicio



Acier chromé  
Chrome steel  
Acero cromado



Scie coupe-bague  
Saw to cut the ring  
Sierra para cortar los anillos



**A85160**

18,5 cm - 7 1/4 "

Lame seule  
Spare blade only  
Hoja sólo



**A85170**

Ø 30 mm

# LANDANGER

Instrumentation de service - Instrumentation for services - Instrumentación de servicio

2/3

## Stylets - Probes - Estiletos



Simple  
Simple  
Simple

**A80010**  
14 cm - 5 1/2 "



Double  
Double  
Doble

**A80020**  
14 cm - 5 1/2 "



Cannelé  
Fluted  
Acanalado

**A80030**  
14 cm - 5 1/2 "



Aiguillé  
With eye  
Agujada

**A80040**  
14 cm - 5 1/2 "



Porte-coton  
Cotton holder  
Porta algodón

**A80050**  
14 cm - 5 1/2 "

## Sondes cannelées - Fluted directors - Sondas acanaladas



**A80070**  
12 cm - 4 3/4 "

**XV - 8**



**A80080**  
14 cm - 5 1/2 "



**A80090**  
16 cm - 6 1/4 "



**Nelaton  
A80100**  
17 cm - 6 3/4 "

Porte-coton  
Cotton holder  
Porta algodón



**A80140**  
40 cm - 15 <sup>3</sup>/<sub>4</sub> "



**A80150**  
30 cm - 11 "

# LANDANGER

## Instrumentation de service - Instrumentation for services - Instrumentación de servicio



Ciseaux à iridectomie  
Iris scissors  
Tijeras para iridectomía



Droit  
Straight  
Recta

**B89000**

11 cm - 4 1/4 "



Courbe  
Curved  
Curva

**B89005**

11 cm - 4 1/4 "

Ciseaux coupe ligature  
Ligature cutting scissors  
Tijeras para cortar ligaduras



Droit  
Straight  
Recta

**B89007**

12 cm - 4 3/4 "

### LISTER



**B890375**

14 cm - 5 1/2 "

**B89038**

18 cm - 7 "

Ciseaux à ongles  
Nail scissors  
Tijeras para uñas



Droit  
Straight  
Recta

**B890090**

10 cm - 4 "



Courbe  
Curved  
Curva

**B890091**

10 cm - 4 "

**XV - 10**

# LANDANGER

Instrumentation de service - Instrumentation for services - Instrumentación de servicio

2/3

Ciseaux mousses  
Blunt scissors  
Roma tijeras

Ciseaux Dauphin - Pointu/Mousse  
Sharp/Blunt scissors  
Aguda/Roma tijeras



Droit  
Straight  
Recta

**B89010**  
14 cm - 5 1/2 "



Courbe  
Curved  
Curva

**B89015**  
14 cm - 5 1/2 "



Droit  
Straight  
Recta

**B89020**  
14 cm - 5 1/2 "



Courbe  
Curved  
Curva

**B89025**  
14 cm - 5 1/2 "

Ciseaux pointu  
Sharp scissors  
Aguda tijeras

MAYO



Droit  
Straight  
Recta

**B89030**  
14 cm - 5 1/2 "



Courbe  
Curved  
Curva

**B89035**  
14 cm - 5 1/2 "

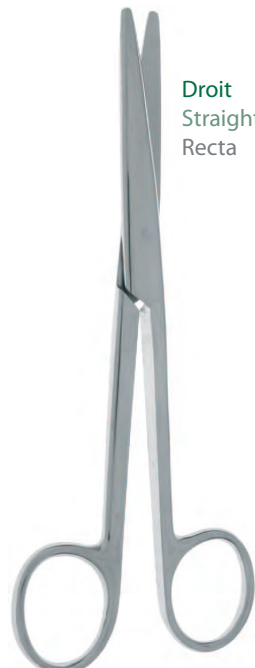

Droit  
Straight  
Recta

**B89036**  
15 cm - 6 "



Courbe  
Curved  
Curva

**B89037**  
15 cm - 6 "

XV - Divers  
XV - Miscellaneous  
XV - Diversos

# LANDANGER

Instrumentation de service - Instrumentation for services - Instrumentación de servicio

2/3

## METZENBAUM

Droit  
Straight  
Recta



**B890390**  
15 cm - 6 "

**B890392**  
18 cm - 7 "

Courbe  
Curved  
Curva



**B890391**  
15 cm - 6 "

**B890393**  
18 cm - 7 "

A griffes  
With teeth  
Con dientes



**B89040**  
**B890460** fine  
14 cm - 5 1/2 "

**B89050**  
16 cm - 6 1/4 "

Pince à dissection  
Dissection forceps  
Pinzas para disección

Sans griffes  
Without teeth  
Sin dientes



**B89045**  
**B890461** fine  
14 cm - 5 1/2 "

**B89055**  
16 cm - 6 1/4 "

## ADSON

A griffes  
With teeth  
Con dientes



**B890570**  
12 cm - 4 3/4 "

Sans griffes  
Without teeth  
Sin dientes



**B890571**  
12 cm - 4 3/4 "

## PEAN



**B89058**  
14 cm - 5 1/2 "



**B89060**  
16 cm - 6 1/4 "



# LANDANGER

Instrumentation de service - Instrumentation for services - Instrumentación de servicio

2/3

## KOCHER

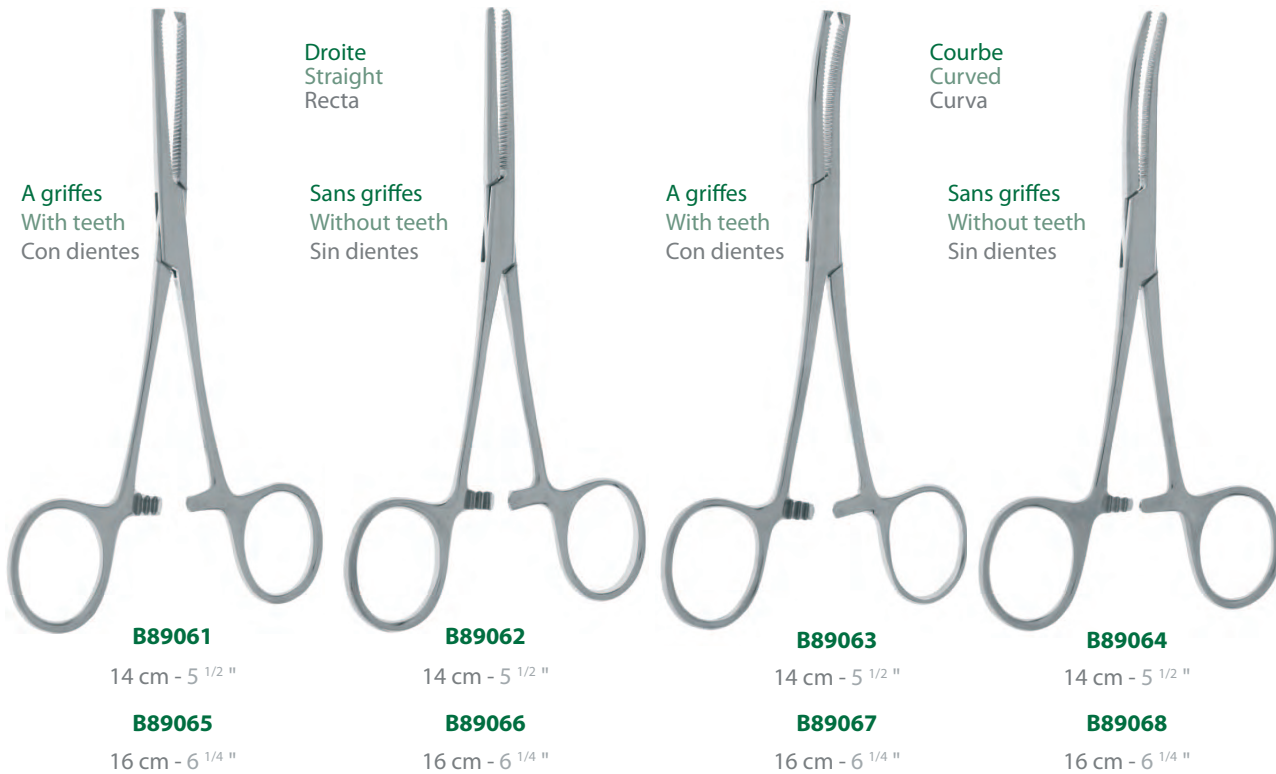

## MAYO-HEGAR

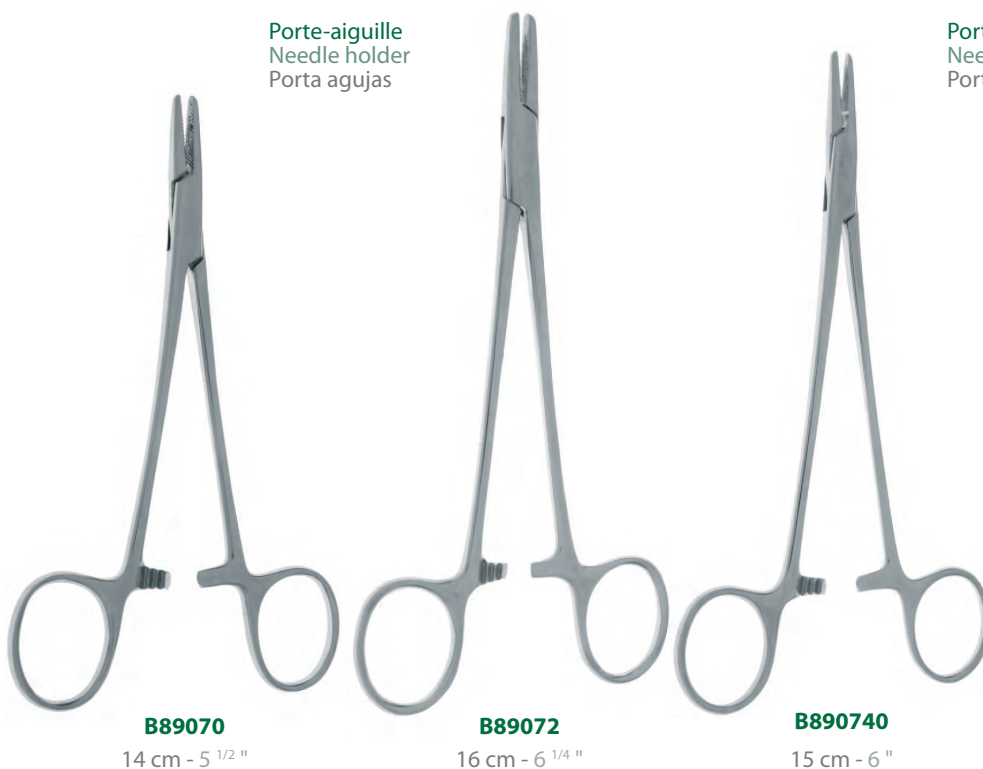

## CRILE-WOOD



# LANDANGER

Instrumentation de service - Instrumentation for services - Instrumentación de servicio

2/3

## HALSTEAD

Pince droite  
Straight forceps  
Pinza recta

Pince courbe  
Curved forceps  
Pinza curva



A griffes  
With teeth  
Con dientes

**B89140**

12 cm - 4 3/4 "



Sans griffes  
Without teeth  
Sin dientes

**B89130**

12 cm - 4 3/4 "



A griffes  
With teeth  
Con dientes

**B89120**

12 cm - 4 3/4 "



Sans griffes  
Without teeth  
Sin dientes

**B89110**

12 cm - 4 3/4 "

## LERICHE

Pince droite  
Straight forceps  
Pinza recta

Pince courbe  
Curved forceps  
Pinza curva



A griffes  
With teeth  
Con dientes

**B89180**

15 cm - 6 "



Sans griffes  
Without teeth  
Sin dientes

**B89170**

15 cm - 6 "



A griffes  
With teeth  
Con dientes

**B89160**

15 cm - 6 "



Sans griffes  
Without teeth  
Sin dientes

**B89150**

15 cm - 6 "

**XV - 14**

Pince à pansement  
Dressing forceps  
Pinza para vendajes

 1/2



**B89090**  
24 cm - 9 1/2 "

## BACKHAUS

Pince à champs  
Towel forceps  
Pinza para campos



**B89100**  
13 cm - 5 "

Pince à ongles  
Nail cutters  
Pinza para uñas



**B891900**  
14 cm - 5 1/2 "

## MURPHY

Presse tube  
Pinchoc clamps  
Cierra tubos



**B892000**  
14 cm - 5 1/2 "

**B892010**  
18 cm - 7 "

# LANDANGER

Instrumentation de service - Instrumentation for services - Instrumentación de servicio



Usage unique non stérile (sachet de 50)  
Disposable no sterile (box of 50)  
Uso unico no esteril (para 50)

Pinces à dissection  
Dressing forceps  
Pinza de disección



**B85010**  
14 cm - 5 1/2 "

Pince clamp  
Clamp forceps  
Pinza clamp



**B85020**  
14 cm - 5 1/2 "

## BRUNS

## WOLF



Ciseaux Bruns à pansements  
et bandages plâtrés  
Bruns clothing scissors,  
plaster scissors  
Bruns tijeras para curas  
y vendajes escayolados

**J76140**  
23,5 cm - 9 1/4 "



Pinces pour plâtres  
Plaster forceps  
Pinzas para escayolas

**J76128**  
18 cm - 7 "

**J76130**  
24 cm - 9 1/2 "

# LANDANGER

## Instruments pour plâtres - Plaster instruments - Instrumentos para escayolas



### HENNING

Pince pour écarter les plâtres  
Plaster cast spreader  
Pinza para romper los vendajes

Pince puissante pour écarter les plâtres  
Strong plaster cast spreader  
Pinza fuerte para romper los vendajes

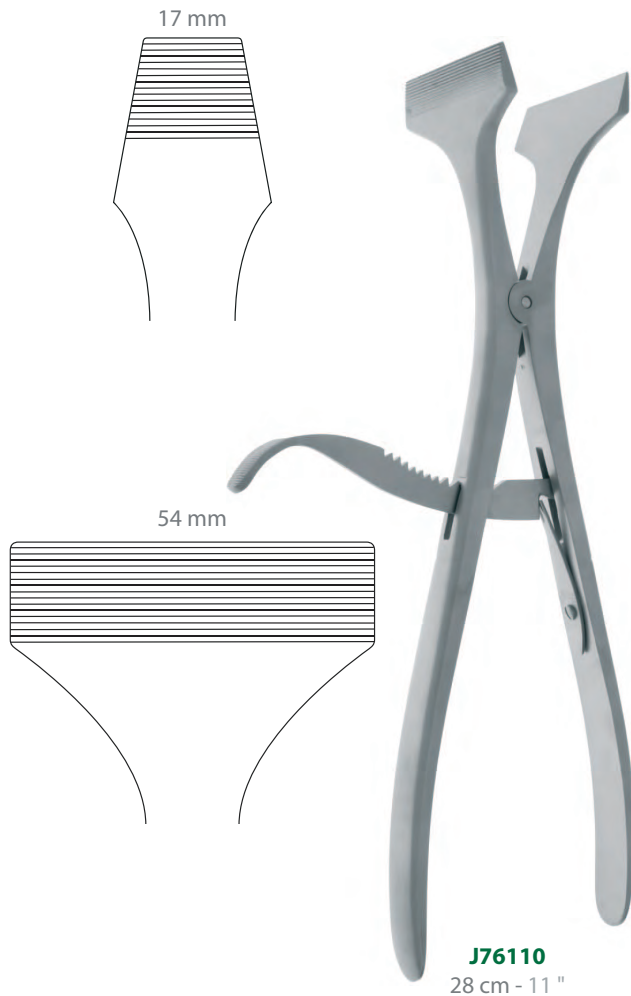

Sans crémaillère - Without rack - Sin cremallera

17 mm **J76080**

54 mm **J76100**

A crémaillère - With rack - Con cremallera

17 mm **J76090**

54 mm **J76110**

# LANDANGER

## Matériel divers - Miscellaneous materials - Materiales varios



Atelles malléables aluminium - Garnies mousse  
Malleables splints aluminium - Foam covered  
Tablillas maleables de aluminio - Adornadas de espuma



L : 25 cm - l : 15 mm	<b>T90090</b>
L : 45 cm - l : 20 mm	<b>T90095</b>
L : 45 cm - l : 25 mm	<b>T90098</b>
L : 45 cm - l : 30 mm	<b>T90100</b>
L : 45 cm - l : 40 mm	<b>T90110</b>
L : 45 cm - l : 50 mm	<b>T90120</b>
L : 45 cm - l : 60 mm	<b>T90130</b>
L : 45 cm - l : 70 mm	<b>T90140</b>
L : 45 cm - l : 80 mm	<b>T90141</b>
L : 45 cm - l : 90 mm	<b>T90143</b>
L : 45 cm - l : 100 mm	<b>T90145</b>

# LANDANGER

## Matériel divers - Miscellaneous materials - Materiales varioso

1/4

Urinal homme - Plastique  
Urinal male - Plastic  
Orinal hombre - Plástico

310 x 135 x 140 mm

**P15055**



Urinal femme - Plastique  
Urinal female - Plastic  
Orinal mujer - Plástico

340 x 120 x 100 mm

**P15060**



Bock à douche - Inox  
Douche can - Stainless steel  
Irrigador inoxidable

Ø 120 mm - H 180 mm - 2 L

**P20010**

1/2



Canules, robinet, tuyau  
Cannulas, tap, tubing  
Canulas, grifo, tubo

**P20015**

140 cm - 55 "

Ø 7 x 10 mm

1/2

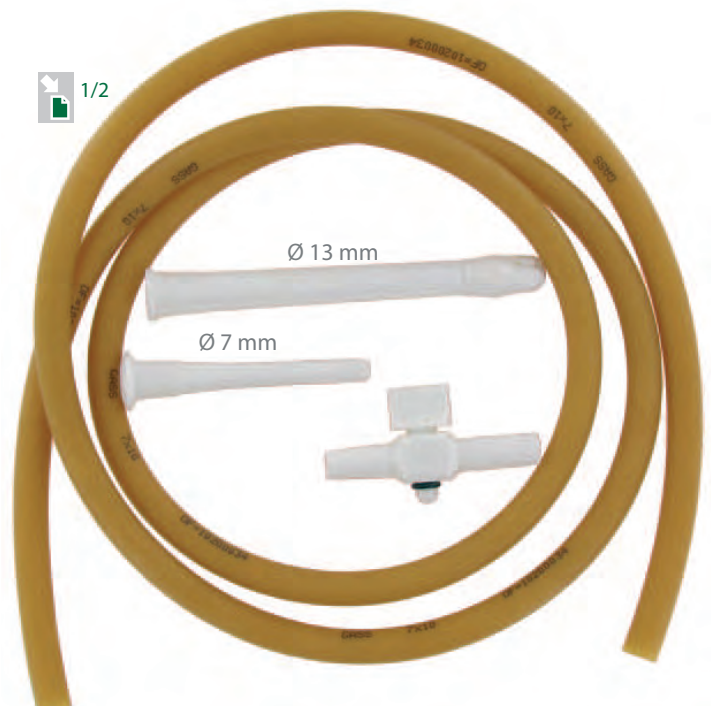

**XV - 20**



# LANDANGER

## Matériel divers - Miscellaneous materials - Materiales varios

1/3

Cupule à bec / Fond plat  
Lotion bowl  
Cupula de pico / Fondo llano



**P35060**

Ø	H		
40 mm	20 mm	20 ml	<b>P35010</b>
50 mm	25 mm	35 ml	<b>P35020</b>
60 mm	30 mm	60 ml	<b>P35030</b>
70 mm	35 mm	85 ml	<b>P35040</b>
80 mm	40 mm	100 ml	<b>P35050</b>
100 mm	50 mm	250 ml	<b>P35060</b>
120 mm	60 mm	500 ml	<b>P35070</b>
160 mm	80 mm	1 l	<b>P35080</b>
200 mm	100 mm	2 l	<b>P35090</b>
250 mm	120 mm	5 l	<b>P35100</b>



Cuvette réniforme (haricot) bords francs - 170 x 95 x 35 mm  
Kidney dish straight edges  
Cubeta reniforme bordes francos

**P45010**



Cuvette réniforme (haricot) bords francs - 250 x 135 x 45 mm  
Kidney dish straight edges  
Cubeta reniforme bordes francos

**P45020**



Cuvette réniforme (haricot) bords roulés - 250 x 135 x 45 mm  
Kidney dish rolled edges  
Cubeta reniforme bordes rodados

**P45030**

Plateaux inox rectangulaires  
Instrument trays stainless steel  
Bandejas acero inoxidable rectangulares



**P75010**

170 x 110 x 20 mm	<b>P75010</b>
200 x 120 x 20 mm	<b>P75020</b>
220 x 140 x 28 mm	<b>P75030</b>
240 x 180 x 30 mm	<b>P75050</b>
260 x 180 x 30 mm	<b>P75060</b>
280 x 180 x 30 mm	<b>P75070</b>
310 x 210 x 40 mm	<b>P75080</b>
350 x 250 x 40 mm	<b>P75090</b>
420 x 280 x 50 mm	<b>P75110</b>
520 x 340 x 50 mm	<b>P75120</b>
200 x 100 x 15 mm	<b>P75125</b>
200 x 150 x 15 mm	<b>P75130</b>

# LANDANGER

Matériel divers - Miscellaneous materials - Materiales varioso

1/2



Aluminium  
Aluminium  
Aluminio

170 x 70 x 30 mm	<b>O05050</b>
180 x 90 x 30 mm	<b>O05070</b>
180 x 90 x 40 mm	<b>O05080</b>

Inox  
Stainless steel  
Acero inoxidable

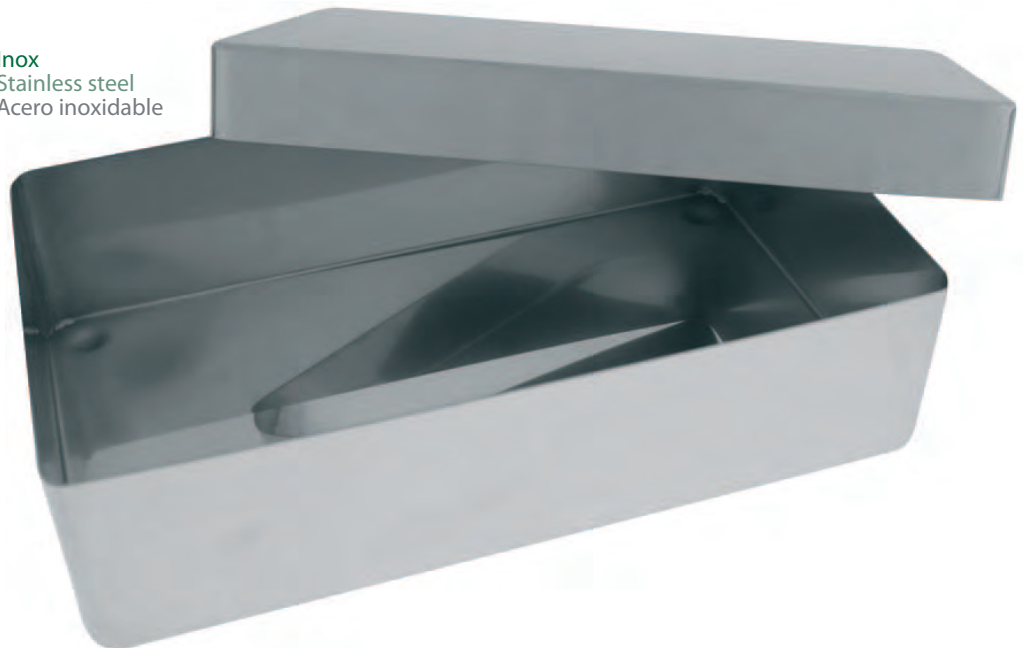

170 x 70 x 30 mm	<b>O10050</b>
180 x 90 x 30 mm	<b>O10070</b>
180 x 90 x 40 mm	<b>O10080</b>
210 x 100 x 50 mm	<b>O10150</b>
250 x 150 x 60 mm	<b>O10200</b>
300 x 150 x 70 mm	<b>O10270</b>
340 x 200 x 80 mm	<b>O10310</b>
400 x 200 x 90 mm	<b>O10400</b>
450 x 200 x 100 mm	<b>O10490</b>

# LANDANGER

Canules aspiratrices - Suction tubes - Cánulas aspirantes



## SANTY



**A90015**  
26 cm - 10 1/4 "

## YANKAUER



**A90090**  
28 cm - 11 "

## NUBOER



**A902000**  
Ø 6 mm  
21 cm - 8 1/4 "

## ANDREW PYNCHON



**A902010**  
23 cm - 9 "

## AUBERT



**A90300**  
36 cm - 14 1/4 "

# LANDANGER

## Matériel divers (canules) - Miscellaneous materials (cannulas) - Materiales varios (cánulas)

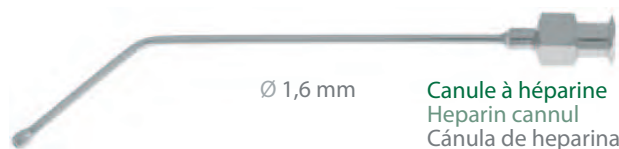

Ø 1,6 mm

Canule à héparine  
Heparin cannul  
Cánula de heparina

**V025650**



Ø 2,5 mm

Canule à héparine coudée court n°1  
Heparin cannula  
Cánula de heparina

**V02570**

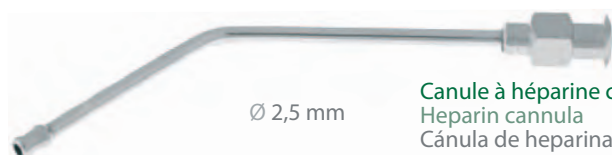

Ø 2,5 mm

Canule à héparine coudée au milieu n°2  
Heparin cannula  
Cánula de heparina

**V02575**



Ø 2,5 mm

Canule à héparine coudée long n°3  
Heparin cannula  
Cánula de heparina

**V02580**

### LUER LOCK

Femelle  
Female  
Hembra



**V028000**

Ø 6 mm



Mâle  
Male  
Macho

**V028001**

# LANDANGER

Matériel divers (trocar) - Miscellaneous materials (trocars) - Materiales varios (trocares)

## MONOD

## BORDIER-MEUNIER



Trocart à biopsie osseuse  
Trocar in osseous biopsy  
Trocare a biopsia ósea

Ø	
7 mm	<b>V02610</b>
8 mm	<b>V02620</b>
9 mm	<b>V02630</b>
10 mm	<b>V02640</b>
11 mm	<b>V02650</b>
12 mm	<b>V02660</b>



**V02610**  
22 cm - 8<sup>3/4</sup> "

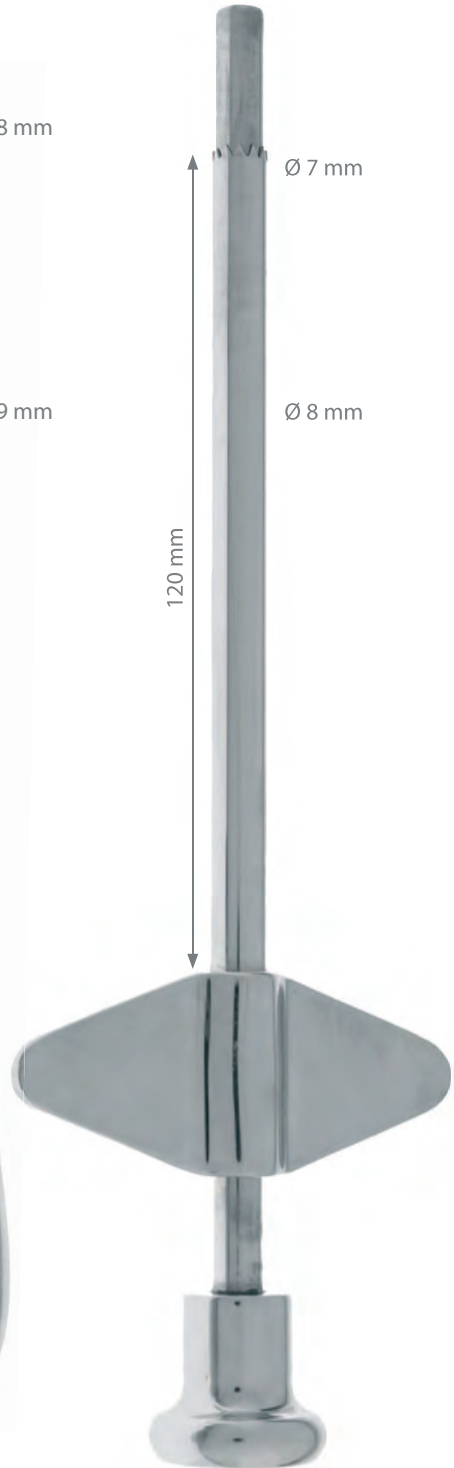
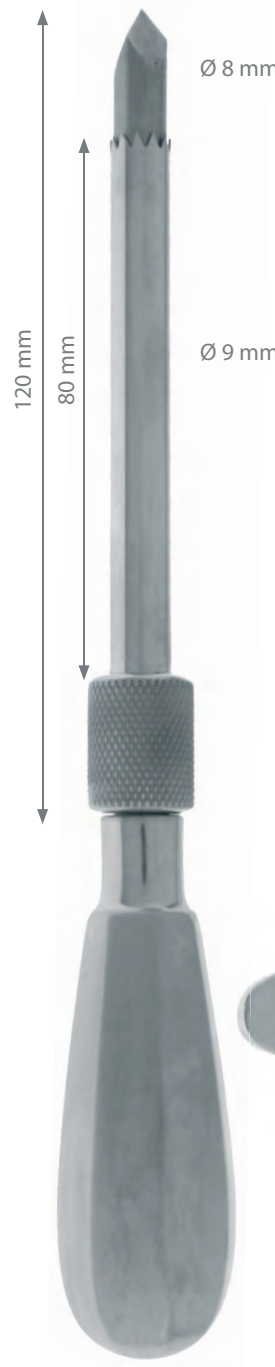

**V036000**

**XV - 25**

# LANDANGER

Matériel divers (aiguilles) - Miscellaneous materials (needles) - Materiales varios (agujas)



Aiguilles à épiler  
Epilation needles  
Agujas para epilacion

4 cm - 1 1/2 "



**Paquet de 10**  
Box of 10  
Para 10

**V035110**  
Ø 10/100

**Paquet de 10**  
Box of 10  
Para 10

**V035115**  
Ø 15/100

# LANDANGER

## Matériel divers (seringues) - Miscellaneous materials (syringe) - Materiales varios (jeringas)



5 cc	<b>V02210</b>
10 cc	<b>V02220</b>
20 cc	<b>V02230</b>

Seringues ultra-asept  
Ultra-asept syringes  
Jeringas ultra-asept

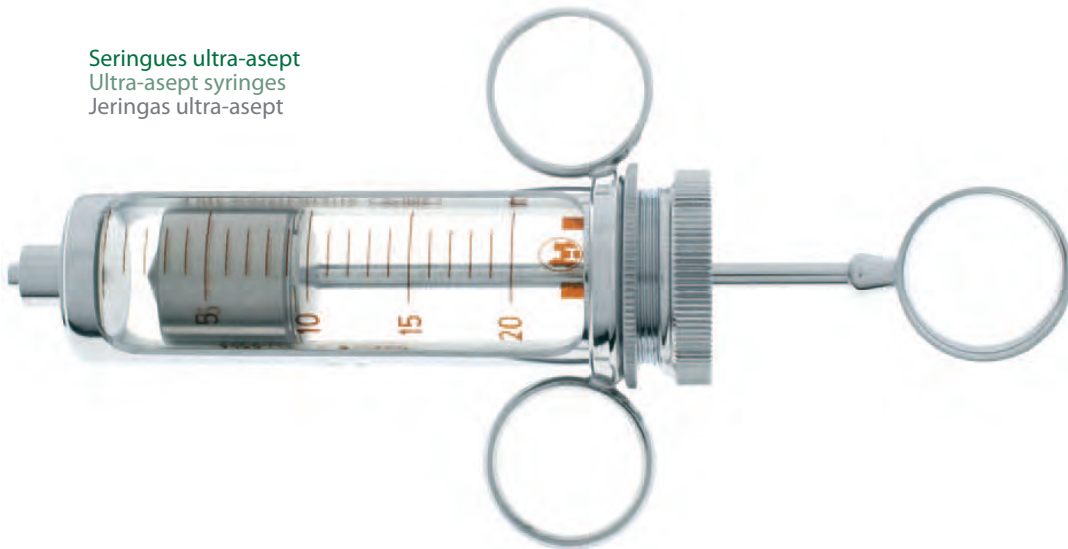

5 cc	<b>V02260</b>
10 cc	<b>V02265</b>
20 cc	<b>V02270</b>



Cylindres de rechange  
Spare cylinders  
Cilindros de recambio

# LANDANGER

Matériel divers - Miscellaneous materials - Materiales varios

1/1

## MAYO

Epingles à instruments  
Instruments pins  
Alfileres de instrumentos



L	
9,5 cm - 3 3/4 "	<b>V78100</b>
12,5 cm - 4 3/4 "	<b>V78110</b>
20 cm - 8 "	<b>V781150</b>

## ENEMA

2/5

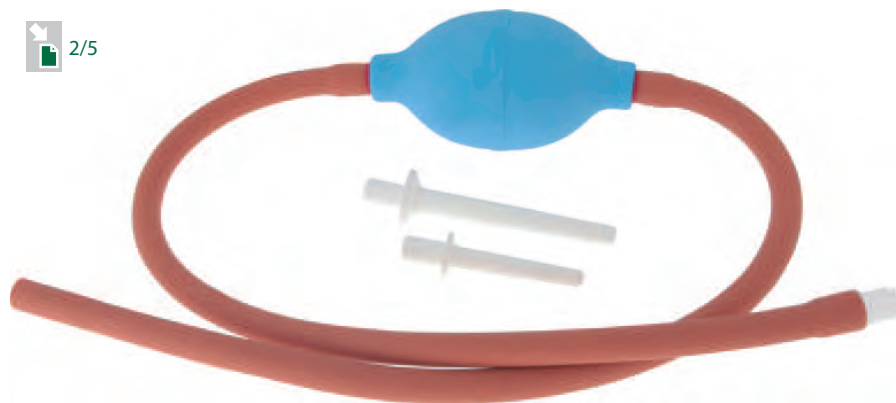

**V78120**  
85 cm - 33 1/2 "

2/5

## GUYON-FREUDENBERG



**V78170**  
41 cm - 16 1/4 "

**XV - 28**



# LANDANGER

Matériel divers - Miscellaneous materials - Materiales varios

## LORTAT-JACOB

 1/3



Cadre pliant 2 fois - 5 branches  
Double folding frame - 5 branches  
Cuadro plegable 2 veces - 5 ramas

V78130

## LANDANGER

 1/4



Support instruments 5 branches démontables  
Instruments holder 5 removable branches  
Soporte de instrumentós 5 ramas desmontables

V78150

# LANDANGER

## Matériel divers - Miscellaneous materials - Materiales varios



IP Spray pour la lubrification  
IP Spray for lubrication  
IP Spray para lubrificación

**V78070**  
400 ml



Nettoyage et rénovation des instruments  
Cleaning and renovation of instruments  
Limpieza y renovación de los instrumentos

**V78300**  
1 L

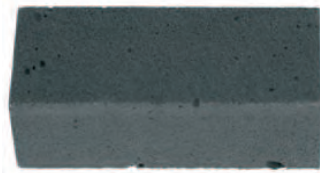

60 x 25 x 20 mm

Gomme polissage  
Polish rubber  
Goma de pulimento

**V784000**



Spray siliconé  
Silicone spray  
Spray de silicona

**V78320**  
500 ml

**XV - 30**

# Index

Références References Referencias	Chapitre Chapter Capítulo	Page Page Página
A05010	XV	1
A05020	XV	1
A05050	XV	1
A20530	XV	2
A20560	XV	2
A20570	XV	2
A20580	XV	2
A25003	XV	4
A25004	XV	4
A25005	XV	4
A25006	XV	4
A25007	XV	4
A25008	XV	4
A25009	XV	4
A25010	XV	4
A25020	XV	4
A300020	XV	3
A30010	XV	3
A30020	XV	3
A30040	XV	3
A30060	XV	5
A30070	XV	5
A30075	XV	5
A80010	XV	8
A80020	XV	8
A80030	XV	8
A80040	XV	8
A80050	XV	8
A80070	XV	8
A80080	XV	8
A80090	XV	8
A80100	XV	8
A80140	XV	9
A80150	XV	9
A85030	XV	6
A85040	XV	6
A85090	XV	6
A85100	XV	6
A85160	XV	7
A85170	XV	7
A86010	XV	6
A86020	XV	6
A860300	XV	6
A86060	XV	6
A90015	XV	23
A90090	XV	23
A902000	XV	23
A902010	XV	23
A90300	XV	23
B05033	I	1
B05060	I	1
B05070	I	1
B05090	I	1
B05103	I	1
B05104	I	1
B110050	I	2
B11013	I	2
B11014	I	3
B12000	I	2
B12001	I	3
B12003	I	2
B12004	I	3
B12005	I	2
B12006	I	2
B12007	I	3
B12008	I	2
B12009	I	3
B123000	I	4
B123001	I	4
B130100	I	2
B13011P	I	2

Références References Referencias	Chapitre Chapter Capítulo	Page Page Página
B130120	I	2
B13015S	I	2
B130180	I	3
B130190	I	3
B130200	I	3
B130210	I	3
B130220	I	3
B130230	I	3
B130240	I	3
B130360	I	3
B130700	I	2
B130710	I	2
B132100	I	5
B13211P	I	5
B132120	I	5
B13215S	I	5
B132180	I	5
B132190	I	5
B132200	I	5
B132210	I	5
B132220	I	5
B132230	I	5
B132240	I	5
B132700	I	5
B134100	I	5
B13411P	I	5
B134120	I	5
B13415S	I	5
B134180	I	5
B134190	I	5
B134200	I	5
B134210	I	5
B134220	I	5
B134230	I	5
B134240	I	5
B20010	I	6
B20015	I	7
B20020	I	7
B20025	I	7
B20030	I	6
B20040	I	6
B20045	I	7
B20050	I	7
B20060	I	7
B201020	I	8
B201040	I	8
B201060	I	8
B25255	III	1
B25260	III	1
B25261	III	1
B25262	III	1
B25265	III	4
B25270	III	4
B25275	III	1
B25280	III	1
B25285	III	1
B25290	III	1
B25295	III	1
B25300	III	1
B25302	III	1
B25303	III	1
B25305	III	2
B25310	III	2
B25311	III	2
B25312	III	2
B25315	III	4
B25320	III	4
B25325	III	2
B25330	III	2
B25335	III	2
B25340	III	2

Références References Referencias	Chapitre Chapter Capítulo	Page Page Página
B25345	III	2
B25350	III	2
B25355	III	3
B25360	III	3
B25365	III	3
B25370	III	3
B25375	III	3
B25380	III	3
B25385	III	3
B25390	III	3
B25395	III	3
B25400	III	3
B25402	III	5
B25403	III	5
B25405	III	5
B25410	III	5
B25415	III	6
B25418	III	6
B25421	III	6
B25426	III	6
B25460	III	9
B25465	III	9
B25470	III	9
B25475	III	9
B25480	III	9
B25483	III	7
B25485	III	7
B25486	III	7
B25489	III	7
B254891	III	7
B254892	III	7
B254893	III	7
B254894	III	7
B25490	III	8
B25495	III	8
B25497	III	8
B25498	III	8
B254981	III	8
B254982	III	8
B255100	III	7
B255101	III	7
B25572	III	10
B25574	III	10
B25576	III	10
B25578	III	10
B255800	III	10
B255801	III	10
B25600	III	10
B25605	III	10
B256070	III	12
B256071	III	12
B256080	III	12
B256081	III	12
B25610	III	13
B25615	III	13
B25620	III	13
B256201	III	14
B256205	III	15
B25625	III	13
B256251	III	14
B256255	III	15
B25630	III	13
B256301	III	14
B256305	III	15
B25635	III	13
B256351	III	14
B256355	III	15
B25640	III	13
B256401	III	14
B256405	III	15
B25645	III	13

# Index

Références References Referencias	Chapitre Chapter Capítulo	Page Page Página
B256451	III	14
B256455	III	15
B25650	III	13
B256501	III	14
B256505	III	15
B25655	III	13
B256551	III	14
B256555	III	15
B25660	III	13
B256605	III	15
B25665	III	13
B256655	III	15
B25670	III	13
B256705	III	15
B25675	III	13
B256760	III	15
B256770	III	15
B25680	III	13
B25685	III	13
B25686	III	11
B25688	III	11
B25692	III	11
B25694	III	11
B25696	III	11
B25700	III	11
B25705	III	16
B25706	III	16
B25707	III	17
B25715	III	16
B25716	III	16
B25717	III	17
B25725	III	16
B25726	III	16
B25727	III	17
B25737	III	19
B25740	III	19
B25745	III	19
B257470	VIII	65
B257471	VIII	65
B257500	VIII	65
B257540	VIII	66
B25755	VIII	66
B257550	VIII	66
B25760	VIII	66
B257610	III	18
B257615	III	18
B25770	III	18
B25775	III	18
B25780	III	20
B25786	III	20
B25795	VI	18
B25800	VI	18
B258015	III	22
B25802	III	21
B258023	III	22
B258024	III	22
B258025	III	22
B258027	III	23
B258028	III	23
B258029	III	23
B25804	III	21
B258043	III	22
B258044	III	22
B258045	III	22
B258047	III	23
B258048	III	23
B258049	III	23
B25806	III	21
B258063	III	22
B258064	III	22
B258065	III	22

Références References Referencias	Chapitre Chapter Capítulo	Page Page Página
B258067	III	23
B258068	III	23
B258069	III	23
B258107	III	23
B258108	III	23
B258109	III	23
B25812	III	21
B258121	III	24
B258128	III	23
B258129	III	23
B25813	III	24
B25814	III	24
B258150	III	24
B25816	III	26
B25817	III	26
B258175	III	26
B258180	III	26
B258181	III	26
B258182	III	26
B258183	III	26
B258184	III	26
B258185	III	26
B25820	III	25
B25825	III	27
B25830	III	27
B25835	III	27
B25840	III	27
B258410	III	28
B258415	III	28
B258445	III	20
B25845	III	20
B25847	III	33
B25848	III	33
B258491	III	25
B258495	III	31
B25850	III	31
B25851	III	31
B25852	III	32
B25853	III	32
B258531	III	32
B258537	III	33
B25854	III	36
B25855	III	36
B25856	III	29
B25857	III	29
B25858	III	29
B25859	III	29
B258590	III	30
B258591	III	30
B258595	III	30
B258596	III	30
B25860	III	37
B25865	III	37
B25870	III	38
B25875	III	38
B25880	III	38
B25885	III	39
B25890	III	39
B25895	III	39
B25900	III	39
B259040	III	40
B259041	III	40
B259042	III	40
B259043	III	40
B25905	III	40
B259051	III	40
B259052	III	40
B259053	III	40
B25920	III	34
B25925	III	34
B25930	III	34

Références References Referencias	Chapitre Chapter Capítulo	Page Page Página
B259330	III	35
B259340	III	35
B25935	III	35
B259620	III	5
B259621	III	5
B35001	III	41
B35002	III	41
B35003	III	41
B35004	III	41
B35005	III	41
B35006	III	41
B35007	III	43
B35008	III	43
B35010	III	43
B35020	III	43
B35030	III	43
B35040	III	43
B35042	III	42
B35043	III	42
B35044	III	42
B35045	III	42
B35046	III	42
B35047	III	42
B35048	III	45
B35049	III	45
B35050	III	45
B35060	III	45
B35070	III	45
B35080	III	45
B35090	III	45
B35100	III	45
B351010	III	45
B351011	III	45
B351020	III	45
B351021	III	45
B35104	III	44
B35106	III	44
B35110	III	44
B35120	III	44
B35130	III	44
B35140	III	44
B35150	III	44
B35160	III	44
B35172	III	44
B35174	III	44
B351750	III	44
B351751	III	44
B351780	III	44
B351781	III	44
B35180	III	48
B35190	III	48
B35200	III	48
B35210	III	48
B35220	III	49
B35228	III	46
B35230	III	46
B35232	III	46
B35234	III	46
B35240	III	44
B35250	III	44
B352580	III	47
B352581	III	47
B35260	III	46
B35270	III	47
B35280	III	47
B40005	II	1
B40010	II	1
B40015	II	1
B40020	II	1
B40021	II	3
B40025	II	1

# Index

Références References Referencias	Chapitre Chapter Capítulo	Page Page Página
B40026	II	3
B40030	II	1
B40031	II	3
B40035	II	1
B40040	II	1
B40045	II	1
B40050	II	1
B40055	II	1
B40060	II	1
B40061	II	3
B40065	II	1
B40066	II	3
B40070	II	1
B40071	II	3
B40075	II	1
B40080	II	1
B40090	II	2
B40092	II	2
B40095	II	2
B400951	II	2
B40100	II	2
B40105	II	2
B40120	II	4
B401220	II	5
B40125	II	4
B401270	II	5
B40130	II	4
B40132	II	5
B40135	II	4
B401370	II	5
B40140	II	4
B401420	II	5
B401430	II	4
B401431	II	5
B401432	II	4
B401433	II	5
B401434	II	4
B401435	II	5
B40145	II	4
B401470	II	5
B40150	II	4
B401520	II	5
B40155	II	4
B40157	II	5
B40160	II	4
B401620	II	5
B40165	II	4
B401670	II	5
B401680	II	4
B401681	II	5
B401682	II	4
B401683	II	5
B401684	II	4
B401685	II	5
B401698	II	6
B401699	II	6
B40170	II	6
B401710	II	6
B401711	II	6
B401748	II	6
B401749	II	6
B40175	II	6
B401760	II	6
B401761	II	6
B401810	II	7
B401811	II	7
B40200	II	8
B40205	II	8
B40210	II	8
B40215	II	8
B402151	II	8

Références References Referencias	Chapitre Chapter Capítulo	Page Page Página
B402152	II	8
B40225	II	9
B40230	II	9
B40235	II	9
B40240	II	9
B40245	II	9
B402451	II	9
B402455	II	10
B40246	II	10
B40248	II	10
B40249	II	10
B402491	II	10
B40250	II	12
B40255	II	12
B40260	II	12
B40265	II	12
B402660	II	12
B40270	II	12
B40275	II	12
B402770	II	12
B40280	II	14
B40285	II	14
B40290	II	14
B40295	II	14
B40300	II	14
B40305	II	14
B40310	II	14
B40315	II	14
B40325	II	15
B40330	II	15
B40335	II	15
B40340	II	15
B40345	II	15
B40350	II	15
B40355	II	16
B40360	II	16
B40365	II	16
B403670	II	16
B403680	II	16
B403690	II	16
B40374	II	11
B40375	II	11
B40380	II	11
B40385	II	11
B40390	II	11
B403950	II	11
B403952	II	22
B403953	II	22
B403954	II	22
B403955	II	22
B40400	II	19
B404010	II	18
B404020	II	19
B404021	II	19
B404022	II	19
B40404	II	23
B404041	II	23
B40406	II	23
B404061	II	23
B404100	II	21
B404101	II	21
B40415	II	13
B40420	II	13
B40425	II	13
B404251	II	13
B404349	II	15
B40435	II	15
B404360	II	15
B404370	II	16
B404371	II	16
B40440	II	17

Références References Referencias	Chapitre Chapter Capítulo	Page Page Página
B40445	II	17
B404450	II	17
B404451	II	17
B404453	II	17
B404454	II	17
B40446	II	17
B40447	II	17
B404470	II	17
B404471	II	17
B40448	II	18
B404490	II	18
B40600	II	35
B40610	II	35
B40620	II	35
B40640	II	35
B40650	II	35
B40660	II	35
B40670	II	35
B40750	II	36
B40760	II	36
B40770	II	36
B40780	II	36
B407810	II	20
B407811	II	20
B407820	II	20
B407821	II	20
B407830	II	20
B407831	II	20
B407840	II	20
B407841	II	20
B407850	II	20
B407851	II	20
B407860	II	20
B407861	II	20
B407900	II	36
B40800	II	24
B408010	II	25
B408020	II	25
B408030	II	25
B40810	II	24
B40820	II	24
B408250	II	24
B40830	II	24
B40840	II	24
B408500	II	26
B408501	II	26
B408510	II	26
B408511	II	26
B408601	II	25
B408602	II	25
B408603	II	25
B408701	II	28
B408702	II	28
B408703	II	28
B408704	II	28
B408705	II	28
B408801	II	27
B408802	II	27
B408804	II	27
B410010	II	27
B410011	II	27
B410020	II	27
B410021	II	27
B410030	II	27
B410031	II	27
B410040	II	27
B410041	II	27
B410100	II	28
B410101	II	28
B410102	II	28
B410110	II	28

# Index

Références References Referencias	Chapitre Chapter Capítulo	Page Page Página
B410111	II	28
B410120	II	28
B410121	II	28
B50010	IV	1
B50020	IV	1
B50025	IV	1
B50050	IV	1
B50055	IV	1
B50070	IV	6
B50075	IV	6
B50085	IV	6
B50200	IV	7
B50202	IV	7
B50205	IV	7
B50207	IV	7
B50210	IV	7
B50212	IV	7
B50215	IV	7
B50217	IV	7
B50220	IV	7
B50225	IV	7
B50230	IV	7
B50231	IV	7
B50235	IV	8
B50236	IV	8
B50240	IV	8
B50242	IV	8
B50245	IV	8
B50247	IV	8
B50250	IV	8
B50252	IV	8
B50255	IV	8
B50257	IV	8
B50265	IV	8
B50267	IV	8
B50272	IV	7
B50274	IV	7
B50276	IV	8
B50278	IV	8
B50282	IV	18
B50284	IV	18
B50286	IV	18
B50288	IV	18
B503000	IV	15
B503001	IV	15
B503010	IV	15
B503011	IV	15
B50330	IV	16
B50335	IV	16
B50340	IV	16
B50345	IV	16
B50350	IV	16
B50355	IV	16
B50360	IV	16
B50365	IV	16
B50370	IV	16
B50375	IV	16
B50380	IV	16
B50385	IV	16
B50410	IV	12
B50415	IV	12
B50420	IV	12
B50425	IV	12
B50430	IV	11
B50435	IV	11
B50440	IV	11
B50445	IV	11
B50446	IV	12
B50447	IV	12
B50448	IV	12
B50449	IV	12

Références References Referencias	Chapitre Chapter Capítulo	Page Page Página
B50455	IV	4
B504560	IV	14
B504561	IV	14
B504562	IV	14
B504563	IV	14
B504564	IV	14
B504565	IV	14
B504566	IV	14
B504567	IV	14
B504580	IV	14
B504581	IV	14
B504582	IV	14
B504583	IV	14
B504584	IV	14
B504585	IV	14
B504586	IV	14
B504587	IV	14
B504590	IV	13
B504591	IV	13
B504592	IV	13
B504593	IV	13
B504594	IV	13
B504595	IV	13
B504596	IV	13
B504597	IV	13
B50465	IV	4
B504651	IV	5
B504652	IV	5
B504653	IV	5
B504661	IV	5
B504662	IV	5
B504663	IV	5
B50555	IV	20
B50560	IV	20
B50565	IV	20
B50570	IV	20
B50575	IV	20
B50580	IV	20
B50585	IV	20
B50590	IV	20
B50595	IV	20
B50600	IV	20
B50605	IV	20
B50610	IV	20
B50615	IV	20
B50620	IV	20
B50625	IV	20
B50630	IV	20
B50632	IV	21
B50634	IV	21
B50636	IV	39
B50660	IV	19
B50665	IV	19
B50670	IV	19
B50675	IV	19
B50680	IV	19
B50685	IV	19
B50690	IV	19
B50695	IV	19
B50700	IV	9
B50705	IV	9
B50706	IV	9
B507065	IV	9
B50707	IV	9
B507080	IV	9
B507081	IV	9
B50710	IV	9
B50715	IV	9
B50720	IV	9
B507210	IV	9
B50725	IV	9

Références References Referencias	Chapitre Chapter Capítulo	Page Page Página
B507261	IV	9
B507262	IV	9
B50730	IV	10
B50735	IV	10
B50740	IV	10
B50745	IV	10
B50746	IV	31
B50747	IV	31
B50748	IV	31
B50749	IV	31
B50750	IV	22
B50755	IV	22
B50760	IV	22
B50765	IV	22
B507660	IV	32
B507661	IV	32
B507662	IV	32
B50767	IV	32
B507701	IV	3
B507702	IV	3
B50780	IV	3
B50785	IV	3
B50793	IV	2
B50794	IV	2
B508000	IV	29
B508001	IV	29
B508002	IV	29
B508003	IV	29
B50805	IV	33
B50810	IV	34
B50830	IV	33
B50835	IV	35
B508400	IV	17
B508401	IV	17
B508450	IV	17
B508451	IV	17
B508455	IV	17
B55260	IV	37
B55280	IV	37
B55300	IV	38
B55310	IV	38
B554000	IV	36
B554005	IV	36
B554010	IV	36
B554015	IV	36
B554020	IV	36
B554025	IV	36
B554030	IV	36
B60140	IV	24
B60150	IV	24
B60160	IV	24
B60180	IV	24
B60190	IV	24
B60200	IV	24
B60220	IV	24
B60230	IV	24
B60240	IV	24
B60260	IV	24
B60270	IV	24
B60280	IV	24
B602900	IV	25
B602902	IV	25
B602904	IV	25
B602906	IV	25
B602908	IV	25
B602910	IV	25
B602912	IV	25
B602914	IV	25
B60330	IV	27
B60340	IV	27
B60350	IV	27

# Index

Références Referencias Referencias	Chapitre Chapter Capítulo	Page Page Página
B60360	IV	27
B60370	IV	76
B60390	IV	76
B603950	IV	76
B60400	IV	76
B60420	IV	76
B60422	IV	76
B60424	IV	76
B60440	IV	28
B60450	IV	23
B60460	IV	23
B60470	IV	23
B60480	IV	23
B605000	IV	47
B605001	IV	47
B605002	IV	47
B605003	IV	47
B605004	IV	47
B605005	IV	47
B605006	IV	47
B605007	IV	47
B605008	IV	47
B605300	IV	40
B605301	IV	40
B60535	IV	40
B60540	IV	41
B60545	IV	41
B60550	IV	41
B60560	IV	41
B60570	IV	41
B60580	IV	41
B60590	IV	41
B60600	IV	41
B60601	IV	42
B60602	IV	42
B60603	IV	42
B60604	IV	42
B60605	IV	42
B60606	IV	42
B60607	IV	42
B60608	IV	42
B60610	IV	43
B60615	IV	43
B60620	IV	43
B60630	IV	43
B60640	IV	43
B60650	IV	43
B60660	IV	43
B60670	IV	43
B60700	IV	45
B60710	IV	44
B60715	IV	44
B60720	IV	44
B60730	IV	44
B60740	IV	44
B60750	IV	44
B60752	IV	44
B60753	IV	44
B60756	IV	45
B607570	IV	49
B607571	IV	49
B607572	IV	55
B607574	IV	55
B60770	IV	30
B60790	IV	30
B607901	IV	30
B607902	IV	30
B60810	IV	52
B60820	IV	52
B60860	IV	53
B60870	IV	53

Références Referencias Referencias	Chapitre Chapter Capítulo	Page Page Página
B60880	IV	62
B60885	IV	62
B60890	IV	62
B60891	IV	54
B60892	IV	54
B60893	IV	54
B60894	IV	45
B60895	IV	45
B60896	IV	57
B60897	IV	57
B609000	IV	48
B609001	IV	48
B609104	IV	48
B609105	IV	48
B609106	IV	48
B609110	IV	26
B609115	IV	26
B609116	IV	26
B612100	IV	46
B612110	IV	46
B612120	IV	46
B612130	IV	46
B612140	IV	46
B612150	IV	46
B612160	IV	46
B612700	IV	46
B612710	IV	46
B612720	IV	46
B612730	IV	46
B612740	IV	46
B612750	IV	46
B612760	IV	46
B613000	IV	50
B613020	IV	50
B613040	IV	50
B613080	IV	50
B613100	IV	50
B613110	IV	51
B613111	IV	51
B613112	IV	51
B613120	IV	51
B640000	IV	55
B65030	IV	57
B65040	IV	57
B65070	IV	56
B65080	IV	56
B650900	IV	56
B651000	IV	56
B65113	IV	64
B65119	IV	64
B651200	IV	64
B65123	IV	64
B65125	IV	64
B65126	IV	64
B65127	IV	66
B651280	IV	66
B65129	IV	66
B65131	IV	66
B65135	IV	63
B651350	IV	63
B651500	IV	69
B651550	IV	69
B651560	IV	69
B65170	IV	67
B65190	IV	67
B65191	IV	67
B65192	IV	67
B65193	IV	67
B65210	IV	68
B65215	IV	68
B65230	IV	65

Références Referencias Referencias	Chapitre Chapter Capítulo	Page Page Página
B65240	IV	65
B65250	IV	65
B65290	IV	71
B65310	IV	71
B65330	IV	72
B65335	IV	72
B65370	IV	72
B65420	IV	72
B65430	IV	72
B65440	IV	72
B654600	IV	74
B654610	IV	74
B654620	IV	74
B65470	IV	73
B65480	IV	73
B65490	IV	73
B65495	IV	73
B65500	IV	73
B65515	IV	75
B65530	IV	75
B655340	IV	77
B655360	IV	77
B655370	IV	70
B656025	IV	70
B70070	IV	78
B70100	IV	78
B70130	IV	79
B70140	IV	79
B70150	IV	79
B70160	IV	79
B70190	IV	80
B70200	IV	80
B702300	IV	78
B702350	IV	78
B702355	IV	78
B702400	IV	78
B702450	IV	81
B702451	IV	81
B702500	IV	81
B702505	IV	81
B713240	XIV	22
B713250	XIV	22
B713260	XIV	22
B713270	XIV	22
B713280	XIV	22
B713290	XIV	22
B713300	XIV	22
B713310	XIV	22
B80081	VII	11
B80083	VII	11
B80085	VII	12
B80090	VII	12
B80095	VII	12
B80100	VII	12
B80105	VII	12
B80110	VII	12
B80115	VII	12
B80117	VII	1
B80120	VII	1
B80125	VII	1
B80130	VII	1
B80135	VII	1
B80136	VII	3
B801363	VII	3
B801364	VII	5
B801365	VII	5
B801366	VII	5
B801367	VII	5
B801368	VII	5
B80137	VII	3
B80140	VII	4

# Index

Références References Referencias	Chapitre Chapter Capítulo	Page Page Página
B80145	VII	4
B801451	VII	4
B801452	VII	4
B801453	VII	4
B801462	VII	32
B801464	VII	32
B801466	VII	32
B801468	VII	32
B801470	VII	32
B801471	VII	32
B801472	VII	32
B801473	VII	32
B801474	VII	6
B801476	VII	6
B801478	VII	6
B801480	VII	4
B801490	VII	21
B801491	VII	21
B801492	VII	21
B801493	VII	21
B80150	VII	22
B80151	VII	23
B80155	VII	22
B80156	VII	23
B80160	VII	22
B80161	VII	23
B80165	VII	22
B80166	VII	23
B80170	VII	22
B80171	VII	23
B80175	VII	22
B80176	VII	23
B80190	VII	22
B80191	VII	23
B80195	VII	22
B80196	VII	23
B80210	VII	22
B80211	VII	23
B80215	VII	22
B80216	VII	23
B80218	VII	24
B80219	VII	24
B80220	VII	24
B80225	VII	24
B80240	VII	24
B80245	VII	24
B80266	VII	24
B80267	VII	24
B80268	VII	27
B80269	VII	27
B80270	VII	27
B80271	VII	27
B802715	VII	34
B802716	VII	34
B802717	VII	34
B802719	VII	37
B80272	VII	36
B80273	VII	36
B80274	VII	36
B802740	VII	31
B802741	VII	31
B802742	VII	37
B802743	VII	31
B802744	VII	31
B802745	VII	31
B802746	VII	31
B802748	VII	31
B802749	VII	31
B80275	VII	29
B80276	VII	29
B80277	VII	29

Références References Referencias	Chapitre Chapter Capítulo	Page Page Página
B802770	VII	29
B802771	VII	33
B802772	VII	33
B802774	VII	33
B802776	VII	33
B80278	VII	33
B80279	VII	33
B80280	VII	33
B80281	VII	33
B80282	VII	33
B80283	VII	33
B80285	VII	33
B802862	VII	11
B802863	VII	11
B802864	VII	11
B802865	VII	11
B802866	VII	25
B802867	VII	25
B802868	VII	25
B802869	VII	25
B802870	VII	25
B802871	VII	25
B802872	VII	25
B802873	VII	25
B802874	VII	25
B802875	VII	25
B802876	VII	25
B802877	VII	25
B802880	VII	26
B802881	VII	26
B802883	VII	26
B802885	VII	30
B802886	VII	30
B802887	VII	30
B802888	VII	30
B802889	VII	30
B802890	VII	30
B802891	VII	30
B802892	VII	30
B802893	VII	30
B802894	VII	30
B80290	VII	77
B802901	VII	77
B802912	VII	77
B802913	VII	77
B802914	VII	77
B802915	VII	77
B802920	VII	35
B802921	VII	35
B802922	VII	45
B802923	VII	45
B802924	VII	45
B802925	VII	45
B802926	VII	46
B802927	VII	46
B802928	VII	46
B802929	VII	44
B802930	VII	44
B802931	VII	44
B80295	VII	77
B80300	VII	77
B80301	VII	15
B80302	VII	15
B80303	VII	15
B80304	VII	15
B80306	VII	15
B803070	VII	17
B803071	VII	17
B803072	VII	17
B803073	VII	17
B803080	VII	16

Références References Referencias	Chapitre Chapter Capítulo	Page Page Página
B803081	VII	16
B803082	VII	16
B803083	VII	16
B803084	VII	16
B803085	VII	16
B803090	VII	16
B803091	VII	16
B803092	VII	16
B803093	VII	16
B803094	VII	16
B803095	VII	16
B803101	VII	13
B803102	VII	13
B803103	VII	13
B803104	VII	13
B803105	VII	13
B803106	VII	13
B80312	VII	15
B80314	VII	15
B80316	VII	15
B80318	VII	15
B80320	VII	77
B80325	VII	19
B803255	VII	20
B80327	VII	19
B803275	VII	20
B80328	VII	19
B803290	VII	20
B80330	VII	19
B803320	VII	17
B80335	VII	17
B80336	VII	17
B80337	VII	17
B80338	VII	14
B80340	VII	14
B80341	VII	14
B80342	VII	14
B80348	VII	18
B80349	VII	18
B80350	VII	18
B80351	VII	18
B80353	VII	18
B80360	VII	28
B80365	VII	28
B80370	VII	28
B80375	VII	28
B80380	VII	7
B80382	VII	7
B80385	VII	7
B80386	VII	8
B80388	VII	8
B80390	VII	9
B803910	VII	8
B803911	VII	8
B803912	VII	8
B803913	VII	8
B803914	VII	8
B803915	VII	8
B803920	VII	8
B803930	VII	8
B803931	VII	8
B803932	VII	8
B803933	VII	8
B803934	VII	8
B803935	VII	8
B803936	VII	8
B803937	VII	8
B803938	VII	8
B803939	VII	8
B803940	VII	10
B803941	VII	10



# Index

Références Referencias Referencias	Chapitre Chapter Capítulo	Page Page Página
B803942	VII	10
B80400	VII	9
B80405	VII	9
B80410	VII	9
B804150	VII	39
B80420	VII	38
B80422	VII	39
B80425	VII	38
B80427	VII	39
B804280	VII	41
B804285	VII	41
B804310	VII	40
B804320	VII	40
B80435	VII	41
B80440	VII	41
B80442	VII	41
B804422	VII	41
B804424	VII	41
B804426	VII	41
B80443	VII	41
B80444	VII	41
B80445	VII	41
B804460	VII	42
B804461	VII	42
B804462	VII	42
B804463	VII	42
B804464	VII	42
B804465	VII	42
B804466	VII	42
B804467	VII	42
B804468	VII	42
B804470	VII	43
B804471	VII	43
B80450	VII	70
B80455	VII	70
B804600	VII	43
B80470	VII	65
B80475	VII	65
B80476	VII	65
B804770	VII	65
B80482	VII	67
B804822	VII	67
B80483	VII	67
B804832	VII	67
B80484	VII	67
B804842	VII	67
B80486	VII	66
B80488	VII	66
B804900	VII	66
B80494	VII	66
B80496	VII	66
B80498	VII	65 - 66
B80500	VII	65 - 66
B80502	VII	69
B80505	VII	68
B80507	VII	68
B80509	VII	68
B80511	VII	68
B80513	VII	68
B80525	VII	78
B805251	VII	78
B80530	VII	78
B805301	VII	78
B80535	VII	79
B805351	VII	79
B80537	VII	79
B805371	VII	79
B80538	VII	90
B80540	VII	90
B805410	VII	91
B80542	VII	80

Références Referencias Referencias	Chapitre Chapter Capítulo	Page Page Página
B80543	VII	82
B80544	VII	82
B80545	VII	83
B80546	VII	83
B80548	VII	85
B80550	VII	84
B80551	VII	84
B80556	VII	85
B80561	VII	85
B80566	VII	85
B80568	VII	86
B80570	VII	86
B80573	VII	86
B80575	VII	86
B80580	VII	87
B80583	VII	87
B80586	VII	88
B80588	VII	88
B80590	VII	47
B80600	VII	48
B80601	VII	48
B80603	VII	50
B80604	VII	50
B80605	VII	48
B80607	VII	49
B80610	VII	48
B80612	VII	49
B80615	VII	48
B80617	VII	49
B806178	VII	50
B80618	VII	51
B80620	VII	53
B80625	VII	53
B80630	VII	53
B80635	VII	53
B80640	VII	52
B80640	VII	52 - 54
B80645	VII	52
B80645	VII	52 - 58
B80650	VII	52
B80650	VII	52 - 58
B80655	VII	52
B80655	VII	52 - 58
B80660	VII	52
B80665	VII	52
B80670	VII	52
B80675	VII	52
B80680	VII	52
B80685	VII	55
B80690	VII	55
B80695	VII	55
B80700	VII	55
B80705	VII	54
B80710	VII	54
B80715	VII	54
B80720	VII	54
B80725	VII	54
B80730	VII	54
B80735	VII	54
B80740	VII	54
B80745	VII	56
B807455	VII	56
B80750	VII	57
B80755	VII	57
B80756	VII	57
B807580	VII	57
B80759	VII	57
B80760	VII	57
B807610	VII	57
B807620	VII	57
B80763	VII	57 - 58

Références Referencias Referencias	Chapitre Chapter Capítulo	Page Page Página
B80765	VII	57
B80767	VII	58
B80770	VII	71
B80775	VII	71
B80780	VII	71
B80785	VII	71
B80790	VII	72
B80792	VII	73
B80794	VII	75
B807942	VII	75
B80795	VII	76
B80800	VII	76
B808086	VII	52
B808087	VII	52
B80810	VII	64
B808110	VII	64
B80812	VII	64
B80813	VII	64
B808133	VII	64
B808134	VII	64
B808135	VII	64
B808136	VII	64
B808137	VII	64
B808138	VII	64
B808139	VII	64
B80815	VII	60
B808159	VII	60
B80820	VII	61
B808201	VII	60
B808202	VII	60
B808206	VII	60
B808209	VII	61
B80822	VII	63
B808221	VII	63
B80823	VII	63
B80824	VII	63
B80826	VII	63
B808300	VII	62
B808301	VII	62
B808310	VII	62
B808311	VII	62
B808312	VII	62
B808313	VII	62
B808340	VII	51
B80835	VII	51
B808360	VII	51
B80840	VII	51
B808410	VII	51
B80845	VII	89
B80850	VII	59
B808510	VII	59
B808515	VII	59
B808516	VII	59
B80855	VII	89
B808570	VII	92
B808571	VII	92
B80860	VII	93
B80865	VII	93
B80870	VII	94
B80874	VII	94
B80878	VII	94
B80880	VIII	28
B80885	VIII	27
B808850	VIII	28
B808851	VIII	28
B808852	VIII	28
B80890	VII	74
B80895	VII	74
B80900	VII	74
B85010	XV	16
B85020	XV	16

# Index

Références References Referencias	Chapitre Chapter Capítulo	Page Page Página
B86205	III	50
B86210	III	50
B86215	III	50
B86220	III	50
B86225	III	50
B86230	III	50
B86235	III	50
B86240	III	50
B86245	III	50
B86250	III	50
B86255	III	50
B86260	III	50
B86265	III	51
B86270	III	51
B86275	III	51
B86280	III	51
B86285	III	51
B86290	III	51
B86295	III	51
B86300	III	51
B86305	III	51
B86310	III	51
B86315	III	51
B86320	III	51
B86325	III	52
B86330	III	52
B86335	III	52
B86340	III	52
B86345	III	52
B86350	III	52
B86355	III	53
B86360	III	53
B86365	III	53
B86370	III	53
B86375	III	53
B86380	III	53
B86385	III	53
B86390	III	54
B86395	III	54
B86400	III	54
B864020	III	55
B864025	III	55
B86405	VIII	67
B86410	III	56
B86415	III	56
B86420	III	56
B86425	III	56
B86500	IV	86
B86505	IV	86
B86510	IV	86
B86515	IV	86
B86520	IV	87
B86525	IV	87
B86530	IV	87
B86535	IV	87
B86540	IV	87
B86545	IV	87
B86550	IV	87
B86555	IV	87
B86560	IV	88
B86570	IV	88
B86580	IV	89
B86590	IV	89
B86595	IV	89
B86600	IV	90
B86610	IV	90
B86700	II	37
B86705	II	37
B86710	II	37
B86715	II	37
B86720	II	37

Références References Referencias	Chapitre Chapter Capítulo	Page Page Página
B86725	II	37
B86730	II	38
B86735	II	38
B86740	II	38
B86745	II	38
B86750	II	39
B86755	II	39
B86760	II	39
B86765	II	39
B86770	II	39
B86775	II	39
B86780	II	40
B86785	II	40
B89000	XV	10
B89005	XV	10
B89007	XV	10
B890090	XV	10
B890091	XV	10
B89010	XV	11
B89015	XV	11
B89020	XV	11
B89025	XV	11
B89030	XV	11
B89035	XV	11
B89036	XV	11
B89037	XV	11
B890375	XV	10
B89038	XV	10
B890390	XV	12
B890391	XV	12
B890392	XV	12
B890393	XV	12
B89040	XV	12
B89045	XV	12
B890460	XV	12
B890461	XV	12
B89050	XV	12
B89055	XV	12
B890570	XV	12
B890571	XV	12
B89058	XV	12
B89060	XV	12
B89061	XV	13
B89062	XV	13
B89063	XV	13
B89064	XV	13
B89065	XV	13
B89066	XV	13
B89067	XV	13
B89068	XV	13
B89070	XV	13
B89072	XV	13
B890740	XV	13
B890750	XV	13
B89090	XV	15
B89100	XV	15
B89110	XV	14
B89120	XV	14
B89130	XV	14
B89140	XV	14
B89150	XV	14
B89160	XV	14
B89170	XV	14
B89180	XV	14
B891900	XV	15
B892000	XV	15
B892010	XV	15
B95017	IV	84
B95020	IV	84
B95025	IV	84
B950450	IV	84

Références References Referencias	Chapitre Chapter Capítulo	Page Page Página
B950460	IV	84
B950470	IV	84
B950480	IV	84
B95060	IV	83
B95100	IV	82
B951020	IV	82
B951030	IV	82
B95150	IV	85
B95200	IV	85
B952014	IV	85
B952018	IV	85
B952020	IV	85
B95205	IV	85
B95210	IV	85
B95250	IV	83
C010106	V	29
C010206	V	29
C010306	V	29
C010406	V	29
C09150	V	29
C091510	V	29
C10005	II	33
C10010	II	33
C10012	II	33
C10013	II	33
C10015	II	33
C10020	II	33
C10025	II	33
C10027	II	33
C10030	II	33
C10035	II	33
C10040	II	33
C10041	II	34
C10042	II	34
C10043	II	34
C10044	II	34
C10045	II	34
C10047	II	33
C10050	II	34
C10055	II	34
C10057	II	34
C10060	V	1
C10065	V	1
C10070	V	1
C10075	V	1
C10080	V	1
C10085	V	1
C10090	V	1
C10095	V	1
C10096	V	2
C10098	V	2
C10099	V	2
C10100	V	1
C10105	V	1
C10110	V	1
C10115	V	1
C10120	V	1
C10125	V	1
C10130	V	1
C10135	V	1
C10140	V	1
C10145	V	2
C10150	V	2
C10155	V	2
C10160	V	2
C10170	V	3
C101701	V	3
C10175	V	3
C101751	V	3
C10180	V	3
C101801	V	3

# Index

Références Referencias Referencias	Chapitre Chapter Capítulo	Page Page Página
C10185	V	3
C101851	V	3
C10190	V	3
C101901	V	3
C10195	V	3
C101951	V	3
C10200	V	3
C102001	V	3
C10205	V	3
C102051	V	3
C10210	V	3
C102101	V	3
C10215	V	3
C102151	V	3
C10220	V	3
C10265	V	4
C10270	V	4
C10275	V	4
C10280	V	4
C10285	V	4
C10290	V	4
C10295	V	4
C10300	V	4
C10310	V	5
C10315	V	5
C10320	V	5
C10325	V	5
C10330	V	5
C10335	V	6
C10340	V	6
C10345	V	6
C10350	V	6
C10355	V	6
C10360	V	6
C10365	V	6
C10370	V	7
C10375	V	7
C10380	V	7
C10385	V	7
C10390	V	7
C10395	V	8
C10400	V	8
C10405	V	11
C10410	V	11
C10415	V	11
C10420	V	12
C10425	V	12
C10430	V	12
C10435	V	12
C10440	V	13
C10445	V	13
C10447	V	13
C10450	V	13
C10455	V	13
C10485	V	9
C10490	V	9
C10495	V	9
C10500	V	9
C10505	V	10
C10510	V	10
C10515	V	10
C10520	V	13
C10522	V	13
C10525	V	13
C10528	V	15
C10530	V	15
C10532	V	15
C10535	V	15
C10540	V	16
C10545	V	16
C10550	V	16

Références Referencias Referencias	Chapitre Chapter Capítulo	Page Page Página
C10555	V	16
C10560	V	16
C10565	V	16
C10570	V	16
C10575	V	17
C10580	V	17
C10585	V	17
C10590	V	17
C10595	V	14
C10600	V	14
C10605	V	14
C10610	V	14
C10615	V	15
C10620	V	15
C10625	V	15
C10630	V	15
C10631	V	18
C10632	V	18
C10633	V	18
C10634	V	18
C10635	V	18
C10640	V	17
C10641	V	17
C10642	V	17
C10643	V	17
C10645	V	18
C10650	V	17
C10651	V	17
C10652	V	17
C10653	V	17
C10655	V	19
C10660	V	18
C10665	V	18
C10670	V	18
C10675	V	19
C10680	V	19
C10685	V	19
C10690	V	20
C10695	V	20
C10700	V	20
C10705	V	20
C10710	V	20
C10715	V	14
C10720	V	23
C10725	V	23
C10730	V	23
C10735	V	23
C10740	V	23
C10742	V	8
C10744	V	9
C10746	V	21
C10748	V	21
C10749	V	21
C10751	V	21
C10753	V	22
C10754	V	22
C10756	V	22
C10765	II	34
C10770	II	34
C10772	V	24
C10774	V	24
C10775	V	25
C10790	V	24
C10795	V	24
C10800	V	24
C10805	V	25
C10810	V	25
C10815	V	25
C10820	V	25
C10825	V	25
C10842	V	25

Références Referencias Referencias	Chapitre Chapter Capítulo	Page Page Página
C10845	V	26
C10850	IV	58
C10855	IV	58
C10860	IV	58
C10865	IV	59
C10870	IV	59
C10875	IV	59
C10880	IV	59
C10890	IV	59
C10895	IV	59
C10900	IV	58
C10905	IV	58
C10910	IV	60
C10915	IV	60
C10920	IV	60
C10925	IV	60
C10930	IV	60
C10935	IV	60
C109500	IV	61
C109501	IV	61
C109502	IV	61
C109503	IV	61
C11005	V	22
C11010	V	22
C11015	V	22
C11020	V	26
C11025	V	26
C11030	V	26
C11035	V	26
C11040	V	26
C11045	V	27
C11050	V	27
C11055	V	27
C11060	V	27
C11065	V	27
C11070	V	27
C11075	V	27
C11080	V	27
C11085	V	27
C11090	V	27
C11095	V	27
C11100	V	27
C11105	V	27
C11110	V	27
C11115	V	28
C11120	V	28
C11125	V	28
C11130	V	28
C11135	V	28
C11140	V	28
C11145	V	28
D01010	X	1
D010110	X	1
D01020	X	1
D010210	X	1
D010290	X	2
D01030	X	2
D010390	X	2
D01040	X	2
D010440	X	3
D010460	X	3
D01050	X	3
D010550	X	3
D01060	X	4
D01070	X	4
D010790	X	4
D01080	X	4
D01090	X	4
D01100	X	4
D01110	VI	18
D011100	X	4

# Index

Références References Referencias	Chapitre Chapter Capítulo	Page Page Página
D011110	X	4
D011120	VI	17
D011130	VI	17
D012000	X	5
D012010	X	5
D012020	X	5
D012030	X	5
D020010	X	6
D020020	X	6
D020030	X	6
D020090	X	7
D02010	X	7
D02020	X	7
D020210	X	7
D020211	X	7
D020220	X	7
D020221	X	7
D020290	X	7
D02030	X	7
D020310	X	7
D020400	X	8
D020401	X	8
D020410	X	8
D020411	X	8
D020420	X	8
D020421	X	8
D020430	X	9
D020431	X	9
D020440	X	9
D020441	X	9
D020442	X	9
D020443	X	9
D020450	X	9
D020451	X	9
D020452	X	9
D020453	X	9
D02050	X	20
D02060	X	20
D03060	X	10
D03070	X	10
D03080	X	10
D03090	X	10
D03100	X	10
D03110	X	10
D03120	X	10
D03130	X	10
D031400	X	11
D031405	X	11
D031410	X	12
D031411	X	12
D031420	X	12
D031421	X	12
D031430	X	12
D031431	X	12
D031440	X	12
D03160	X	11
D03170	X	13
D03180	X	13
D031900	X	13
D031910	X	13
D031920	X	13
D032000	X	14
D032010	X	14
D032020	X	14
D032030	X	14
D033000	X	14
D034000	X	15
D034010	X	15
D035000	X	16
D035010	X	16
D035020	X	16

Références References Referencias	Chapitre Chapter Capítulo	Page Page Página
D035030	X	16
D04010	X	17
D04020	X	17
D040210	X	17
D040211	X	17
D040212	X	17
D04040	X	18
D040410	X	18
D040411	X	18
D040420	X	19
D040430	X	19
D040440	X	19
D040441	X	19
D04050	X	18
D04060	X	18
D040700	X	19
D040710	X	19
D040800	X	20
D040801	X	20
D040802	X	20
F05100	III	36
F05110	III	36
F05120	III	36
F05130	VIII	65
F05160	III	36
F05170	III	49
F05175	III	49
F05180	VIII	67
F051850	VIII	67
F051900	VIII	67
F10030	VIII	1
F10040	VIII	1
F10050	VIII	1
F10060	VIII	1
F10100	VIII	1
F102000	VIII	3
F102001	VIII	3
F102010	VIII	3
F102011	VIII	3
F102050	VIII	3
F102051	VIII	3
F10210	VIII	2
F10220	VIII	2
F10230	VIII	2
F10240	VIII	2
F10340	VIII	4
F10350	VIII	4
F10360	VIII	4
F10380	VIII	5
F10390	VIII	5
F10400	VIII	5
F104100	VIII	5
F10420	VIII	6
F10450	VIII	6
F104580	VIII	7
F10460	VIII	8
F10470	VIII	8
F10480	VIII	9
F10505	VIII	9
F10515	VIII	9
F10516	VIII	10
F105450	VIII	10
F10550	VIII	11
F10570	VIII	11
F105760	VIII	11
F10580	VIII	12
F10590	VIII	12
F105910	VIII	13
F105911	VIII	13
F105912	VIII	13
F105913	VIII	13

Références References Referencias	Chapitre Chapter Capítulo	Page Page Página
F105920	VIII	13
F105921	VIII	13
F105922	VIII	13
F105923	VIII	13
F106040	VIII	13
F10605	VIII	14
F106060	VIII	14
F10610	VIII	16
F10620	VIII	17
F10630	VIII	16
F10640	VIII	17
F10690	VIII	18
F107050	VIII	51
F10710	VIII	19
F107105	VIII	19
F10720	VIII	20
F107205	VIII	20
F107210	VIII	20
F10730	VIII	21
F10732	VIII	21
F107330	VIII	22
F10735	VIII	22
F10736	VIII	22
F10737	VIII	23
F10738	VIII	23
F10740	VIII	50
F10755	VIII	50
F10780	VIII	49
F107870	VIII	21
F107900	VIII	49
F10800	VIII	49
F108200	VIII	15
F108205	VIII	15
F15310	VIII	24
F15320	VIII	24
F15340	VIII	25
F15350	VIII	25
F153610	VIII	26
F153620	VIII	26
F15370	VIII	29
F15380	VIII	29
F15390	VIII	29
F15410	VIII	29
F15414	VIII	29
F15420	VIII	29
F16000	VIII	30
F16010	VIII	30
F16020	VIII	30
F16030	VIII	30
F16034	VIII	30
F16038	VIII	30
F16040	VIII	30
F16050	VIII	30
F16060	VIII	30
F16070	VIII	33
F16080	VIII	33
F16090	VIII	33
F16100	VIII	33
F16110	VIII	33
F16120	VIII	33
F16130	VIII	33
F16140	VIII	33
F16150	VIII	33
F16160	VIII	33
F16170	VIII	33
F16180	VIII	33
F16190	VIII	33
F16200	VIII	33
F16210	VIII	34
F16220	VIII	34
F16230	VIII	34

# Index

Références Referencias Referencias	Chapitre Chapter Capítulo	Page Page Página	Références Referencias Referencias	Chapitre Chapter Capítulo	Page Page Página	Références Referencias Referencias	Chapitre Chapter Capítulo	Page Page Página
F16240	VIII	34	F25175	VIII	47	F304322	VIII	58
F16250	VIII	34	F251770	VIII	47	F30435	VIII	58
F17025	VIII	30	F25180	VIII	47	F30455	VIII	59
F17030	VIII	30	F25185	VIII	47	F305000	VIII	51
F17035	VIII	30	F251900	VIII	47	F315005	VIII	60
F17040	VIII	30	F260010	VIII	48	F315006	VIII	60
F17130	VIII	32	F260020	VIII	48	F315007	VIII	60
F17135	VIII	32	F260030	VIII	48	F315015	VIII	60
F17140	VIII	32	F260040	VIII	48	F315016	VIII	60
F17165	VIII	34	F260050	VIII	48	F315017	VIII	60
F17630	VIII	35	F260060	VIII	48	F315020	VIII	60
F17634	VIII	35	F260070	VIII	48	F315021	VIII	60
F17638	VIII	35	F260080	VIII	48	F315022	VIII	60
F17734	VIII	35	F260090	VIII	48	F315122	VIII	60
F17738	VIII	35	F260100	VIII	48	F36010	VIII	61
F178000	VIII	30 - 32 - 35	F260110	VIII	48	F36015	VIII	61
F18125	VIII	31	F260120	VIII	48	F36020	VIII	61
F18130	VIII	31	F30010	VIII	52	F36025	VIII	61
F18135	VIII	31	F30015	VIII	52	F36030	VIII	61
F18230	VIII	31	F30020	VIII	52	F36035	VIII	61
F18235	VIII	31	F30030	VIII	52	F36040	VIII	61
F18240	VIII	31	F30040	VIII	52	F36045	VIII	61
F190010	VIII	36	F30050	VIII	52	F36050	VIII	61
F200050	VIII	37	F30060	VIII	52	F36055	VIII	61
F200060	VIII	37	F30070	VIII	52	F36060	VIII	61
F200061	VIII	37	F30080	VIII	53	F36065	VIII	61
F20010	VIII	38	F30090	VIII	53	F36070	VIII	61
F20020	VIII	38	F30100	VIII	53	F36075	VIII	61
F20030	VIII	38	F30110	VIII	53	F36080	VIII	61
F20070	VIII	38	F30120	VIII	53	F36085	VIII	61
F20090	VIII	39	F30130	VIII	53	F36090	VIII	61
F20092	VIII	39	F30140	VIII	53	F36095	VIII	61
F20160	VIII	39	F30150	VIII	53	F36100	VIII	61
F20165	VIII	40	F30160	VIII	53	F36105	VIII	61
F20290	VIII	39	F30170	VIII	54	F36110	VIII	61
F20295	VIII	39	F30180	VIII	54	F36115	VIII	61
F20300	VIII	39	F30190	VIII	54	F36120	VIII	61
F25010	VIII	41	F30200	VIII	54	F36125	VIII	61
F250110	VIII	41	F30210	VIII	54	F36130	VIII	61
F25020	VIII	41	F30220	VIII	54	F36135	VIII	61
F250210	VIII	41	F30230	VIII	54	F36140	VIII	61
F25025	VIII	41	F30245	VIII	55	F36145	VIII	61
F250280	VIII	42	F30250	VIII	55	F36150	VIII	61
F25030	VIII	42	F30260	VIII	55	F36155	VIII	61
F25035	VIII	42	F30270	VIII	55	F36160	VIII	61
F25040	VIII	42	F30280	VIII	55	F36170	VIII	61
F250450	VIII	42	F30290	VIII	55	F36180	VIII	61
F25050	VIII	42	F30300	VIII	55	F36185	VIII	61
F25060	VIII	42	F30311	VIII	56	F36190	VIII	61
F25070	VIII	42	F30312	VIII	56	F36195	VIII	61
F25080	VIII	42	F30313	VIII	56	F36200	VIII	61
F25100	VIII	43	F30314	VIII	56	F36210	VIII	61
F25105	VIII	43	F30316	VIII	56	F36220	VIII	61
F25110	VIII	44	F30317	VIII	56	F36230	VIII	61
F25115	VIII	44	F30319	VIII	56	F36240	VIII	61
F25120	VIII	45	F30332	VIII	56	F36250	VIII	61
F25125	VIII	45	F30333	VIII	56	F36260	VIII	61
F251280	VIII	46	F30334	VIII	56	F362610	VIII	61
F251281	VIII	46	F30335	VIII	56	F362620	VIII	61
F251290	VIII	46	F30336	VIII	56	F362630	VIII	61
F25130	VIII	47	F30337	VIII	56	F362640	VIII	61
F25135	VIII	47	F30338	VIII	56	F36270	VIII	62
F25140	VIII	47	F30340	VIII	57	F36275	VIII	62
F25145	VIII	47	F30350	VIII	57	F36280	VIII	62
F25150	VIII	47	F30360	VIII	57	F36285	VIII	62
F25155	VIII	47	F30370	VIII	57	F36300	VIII	64
F25160	VIII	47	F30380	VIII	57	F36310	VIII	64
F251640	VIII	47	F30390	VIII	57	F36315	VIII	64
F25165	VIII	47	F30420	VIII	58	F36400	VIII	63
F25170	VIII	47	F30432	VIII	58	F36410	VIII	63
F251720	VIII	47	F304321	VIII	58	F36420	VIII	63

# Index

Références References Referencias	Chapitre Chapter Capítulo	Page Page Página
F36430	VIII	63
F36440	VIII	63
F36450	VIII	63
F36460	VIII	63
F36470	VIII	63
F36480	VIII	63
F36485	VIII	63
F36490	VIII	63
F36494	VIII	63
F36498	VIII	63
F365050	VIII	63
F365060	VIII	63
F365070	VIII	63
F365080	VIII	63
F365090	VIII	63
F365100	VIII	63
G25010	VI	3
G25020	VI	3
G25030	VI	3
G25040	VI	3
G25050	VI	2
G25060	VI	1
G25061	VI	1
G25062	VI	1
G25070	VI	2
G25080	VI	2
G25135	VI	3
G25140	VI	3
G25150	VI	3
G25160	VI	3
G252601	VI	4
G252701	VI	4
G252801	VI	4
G25390	VI	4
G25400	VI	4
G25410	VI	4
G25420	VI	4
G25430	VI	4
G25440	VI	4
G300050	VI	5
G30010	VI	5
G300150	VI	5
G30050	VI	6
G30060	VI	6
G30070	VI	6
G30080	VI	5
G30082	VI	7
G30084	VI	7
G30086	VI	7
G30088	VI	7
G30090	VI	9
G300950	VI	9
G30100	VI	9
G30110	VI	9
G30120	VI	9
G30130	VI	9
G30140	VI	9
G30150	VI	9
G30151	VI	8
G30152	VI	13
G301521	VI	13
G30153	VI	13
G301531	VI	13
G30154	VI	13
G301541	VI	13
G30155	VI	13
G301551	VI	13
G30156	VI	13
G301561	VI	13
G30158	VI	8
G30159	VI	8

Références References Referencias	Chapitre Chapter Capítulo	Page Page Página
G30160	VI	14
G301601	VI	14
G30164	VI	14
G301641	VI	14
G30170	VI	14
G301701	VI	14
G30180	VI	14
G301801	VI	14
G30182	VI	14
G301821	VI	14
G30190	VI	14
G301901	VI	14
G30200	VI	17
G30210	VI	10
G30220	VI	10
G30230	VI	10
G30240	VI	10
G30250	VI	10
G30260	VI	10
G30270	VI	10
G30280	VI	11
G30290	VI	11
G30300	VI	11
G30310	VI	11
G303210	VI	15
G303215	VI	15
G303220	VI	15
G303221	VI	15
G303222	VI	15
G303223	VI	15
G30370	VI	12
G30380	VI	12
G30390	VI	12
G30440	VI	16
G30450	VI	16
G30460	VI	16
G30610	VI	19
G306300	VI	19
G30640	VI	19
G35004	VI	20
G35008	VI	20
G35012	VI	20
G35016	VI	20
G35132	VI	20
G35136	VI	20
G35140	VI	20
G35144	VI	20
G40050	VI	21
G40060	VI	21
G40070	VI	21
G40080	VI	21
G40100	VI	22
G40110	VI	22
G40120	VI	22
G40135	VI	22
G401355	VI	22
G401360	VI	22
G401750	VI	23
G40180	VI	23
G40190	VI	23
G401950	VI	23
G40200	VI	23
G402050	VI	23
G402070	VI	23
G40210	VI	23
G40215	VI	23
G402350	VI	23
G40240	VI	23
G40250	VI	23
G402550	VI	23
G40260	VI	23

Références References Referencias	Chapitre Chapter Capítulo	Page Page Página
G402650	VI	23
G402670	VI	23
G40270	VI	23
G40275	VI	23
G40340	VI	24
G403401	VI	24
G40350	VI	24
G403501	VI	24
G403510	VI	24
G403520	VI	24
H10010	IX	1
H10020	IX	1
H10030	IX	1
H10040	IX	1
H10050	IX	1
H10060	IX	2
H10070	IX	2
H10080	IX	2
H10090	IX	2
H10100	IX	3
H10115	IX	3
H10120	IX	3
H10130	IX	3
H10140	IX	4
H10145	IX	4
H10150	IX	4
H10155	IX	4
H10175	IX	5
H20010	IX	5
H20025	IX	6
H20030	IX	6
H20040	IX	6
H20050	IX	6
H20060	IX	6
H20070	IX	6
H20071	IX	6
H20072	IX	6
H20080	IX	6
H20081	IX	6
H20082	IX	6
H20083	IX	6
H20085	IX	7
H20087	IX	7
H20089	IX	7
H20091	IX	7
H20093	IX	7
H20095	IX	7
H20110-0	IX	8
H250140	IX	9
H250160	IX	9
H250180	IX	9
H250200	IX	9
H250220	IX	9
H250240	IX	9
H250260	IX	9
H250280	IX	9
H250300	IX	9
H250320	IX	9
H250340	IX	9
H250360	IX	9
H250380	IX	9
H250400	IX	9
H250420	IX	9
H250440	IX	9
H250460	IX	9
H250480	IX	9
H250500	IX	9
H250520	IX	9
H250540	IX	9
H250560	IX	9
H250580	IX	9

# Index

Références References Referencias	Chapitre Chapter Capítulo	Page Page Página
H250600	IX	9
H251010	IX	8
H251012	IX	8
H251016	IX	8
H251018	IX	8
H251110	IX	8
H251112	IX	8
H251116	IX	8
H40010	IX	10
H40020	IX	10
H40030	IX	10
H40040	IX	10
H40050	IX	10
H40060	IX	10
H40070	IX	10
H40080	IX	10
H40090	IX	10
H40100	IX	10
H40110	IX	10
H40120	IX	10
H40130	IX	10
I05010	XII	1
I05030	XII	1
I05040	XII	1
I05050	XII	2
I05060	XII	2
I050690	XII	3
I05070	XII	3
I05080	XII	3
I050810	XII	3
I05130	XII	4
I051310	XII	4
I10010	XII	5
I10015	XII	5
I10020	XII	5
I10022	XII	6
I10024	XII	6
I15010	XII	7
I15020	XII	7
I150250	XII	7
I15030	XII	7
I15032	XII	8
I15034	XII	8
I15036	XII	8
I15038	XII	8
I15042	XII	8
I15044	XII	8
I15050	II	30
I150501	II	30
I150502	II	30
I150503	II	30
I150504	II	30
I150505	II	30
I15060	II	30
I150601	II	30
I150602	II	30
I150603	II	30
I150604	II	30
I150605	II	30
I150610	II	31
I150611	II	31
I150612	II	31
I150620	II	32
I150621	II	32
I150630	II	32
I150640	II	32
I15070	XII	9
I15080	XII	9
I150810	XII	10
I150815	XII	10
I150820	XII	10

Références References Referencias	Chapitre Chapter Capítulo	Page Page Página
I150890	II	29
I150895	II	29
I15110	II	29
I15120	II	29
I151305	XII	11
I15140-0	XII	11
I15141-0	XII	11
I15142-0	XII	11
I15145-0	XII	11
I15146-0	XII	11
I15147-0	XII	11
I15148-0	XII	11
I15150	XII	11
I15151	XII	11
I15160	XII	11
I15170	XII	11
I15175	XII	12
I15180	XII	12
I15185	XII	12
I15190	XII	13
I15200	XII	13
I15208	XII	13
I15220	XII	14
I15230	XII	14
I15232	XII	14
I15234	XII	14
I15240	XII	14
I15250	XII	14
I15330	XII	17
I15340	XII	15
I15342	XII	15
I15344	XII	15
I15346	XII	15
I15348	XII	15
I15350	XII	15
I15360	XII	15
I15370	XII	15
I15400	XII	16
I15410	XII	16
I15420	XII	16
I15430	XII	16
I15440	XII	16
I15450	XII	16
I15460	XII	16
I15470	XII	16
I15480	XII	16
I15490	XII	16
I15495	XII	17
I15500	XII	17
I15701	XII	18
I15703	XII	18
I15704	XII	18
I15705	XII	18
I16010	XII	19
I16015	XII	19
I16020	XII	19
I160250	XII	20
I160260	XII	20
I16035	XII	21
I16040	XII	22
I16045	XII	19
I16055	XII	20
I160570	XII	20
I16060	XII	20
I16100	XII	23
I16102	XII	23
I16104	XII	23
I16106	XII	23
I16108	XII	23
I16110	XII	23
I16112	XII	23

Références References Referencias	Chapitre Chapter Capítulo	Page Page Página
I16114	XII	23
I170005	XII	24
I17001	XII	24
I170010	XII	24
I170011	XII	24
I170012	XII	24
I170013	XII	24
I17005	XII	25
I17010	XII	25
I17015	XII	25
I17020	XII	25
I17025	XII	25
I17030	XII	25
I17035	XII	25
I17040	XII	25
I17045	XII	25
I170460	XII	25
I170461	XII	25
I17050	XII	25
I17055	XII	25
I17060	XII	25
I17065	XII	25
I17070	XII	25
I17075	XII	25
I17080	XII	25
I17085	XII	25
I17090	XII	25
I170920	XII	26
I170924	XII	26
I170926	XII	26
I170928	XII	26
I170940	XII	26
I170941	XII	26
I170942	XII	26
I17100	XII	27
I17102	XII	27
I17104	XII	27
I171060	XII	27
I17108	XII	26
I17110	XII	26
I17112	XII	28
I17114	XII	34
I17116	XII	28
I17118	XII	28
I17124	XII	28
I171260	XII	29
I171265	XII	29
I171270	XII	29
I171274	XII	30
I171275	XII	30
I171280	XII	30
I171290	VII	18
I171290	XII	34
I171292	VII	18
I171292	XII	34
I171295	VII	18
I171295	XII	34
I171297	VII	18
I171297	XII	34
I171300	VII	18
I171300	XII	34
I171305	XII	31
I171308	XII	31
I171310	XII	31
I171311	XII	31
I171312	XII	31
I17135	XII	31
I171360	XII	32
I171365	XII	32
I171370	XII	32
I171380	XII	33

# Index

Références References Referencias	Chapitre Chapter Capítulo	Page Page Página
I171381	XII	33
I171390	XII	33
I17140	XII	36
I17142	XII	36
I17144	XII	36
I17146	XII	36
I17148	XII	36
I171481	XII	36
I17150	XII	34
I17155	XII	34
I17160	XII	37
I17162	XII	37
I180022	XII	38
I180023	XII	38
I180030	XII	38
I180031	XII	38
I180032	XII	38
I180033	XII	38
I180035	XII	38
I180036	XII	38
I180037	XII	38
I180038	XII	38
I18005	XII	37
I18010	XII	37
I18020	XII	37
I18021	XII	39
I18022	XII	39
I18024	XII	39
I18025	XII	39
I18027	XII	39
I18028	XII	39
I18030	XII	39
I18031	XII	39
I18033	XII	39
I18034	XII	39
I18036	XII	39
I18037	XII	39
I180380	XII	38
I180381	XII	38
I180385	XII	38
I180386	XII	38
I180387	XII	38
I18040-0	XII	40
I18042-0	XII	40
I18044-0	XII	40
I18046-0	XII	40
I180502	XII	40
I180503	XII	40
I180504	XII	40
I180515	XII	40
I182015	XII	40
I182020	XII	40
I182025	XII	40
I182030	XII	40
I19010	XII	35
I19020	XII	35
I19030	XII	35
I19040	XII	35
I19050	XII	35
J04010	XIII	1
J04040	XIII	1
J04050	XIII	1
J04060	XIII	2
J04070	XIII	2
J04090	XIII	2
J041000	XIII	3
J041010	XIII	3
J041020	XIII	3
J041030	XIII	3
J041040	XIII	3
J041050	XIII	3

Références References Referencias	Chapitre Chapter Capítulo	Page Page Página
J08010	XI	1
J080101	XI	1
J08030	XI	1
J08031	XI	1
J08035	XI	1
J08060	XI	1
J08070	XI	2
J08080	XI	2
J12030	XIII	4
J12060	XIII	4
J120650	XIII	4
J120651	XIII	4
J120652	XIII	4
J120700	XIII	4
J120710	XIII	4
J120827	XIII	5
J120828	XIII	5
J120830	XIII	5
J120831	XIII	5
J121610	XIII	5
J121612	XIII	5
J121615	XIII	5
J12180	XIII	6
J12190	XIII	6
J12220	XIII	6
J12225	XIII	6
J12240	XIII	7
J12250	XIII	7
J12260	XIII	7
J12270	XIII	8
J12285	XIII	7
J14140	XIII	8
J14145	XIII	8
J150100	XI	3
J150110	XI	3
J150120	XI	3
J150130	XI	3
J150140	XI	3
J150150	XI	3
J150160	XI	3
J150170	XI	3
J150180	XI	3
J150190	XI	3
J151001	XI	4
J151002	XI	4
J151010	XI	4
J151011	XI	4
J151012	XI	4
J151013	XI	4
J151020	XI	4
J151021	XI	4
J151022	XI	4
J151023	XI	4
J151030	XI	4
J151031	XI	4
J151040	XI	5
J151041	XI	5
J151042	XI	5
J151043	XI	5
J151044	XI	5
J151045	XI	5
J151050	XI	5
J151051	XI	5
J151052	XI	5
J151053	XI	5
J152100	XI	6
J152101	XI	6
J152110	XI	6
J152111	XI	6
J152120	XI	6
J152121	XI	6

Références References Referencias	Chapitre Chapter Capítulo	Page Page Página
J16010	XI	7
J16020	XI	7
J16030	XI	7
J16040	XI	7
J16050	XI	7
J16060	XI	7
J16065	XI	7
J16075	XI	7
J160760	XI	7
J160770	XI	7
J160780	XI	7
J160790	XI	7
J161000	XI	8
J161010	XI	8
J161020	XI	8
J161030	XI	8
J161040	XI	8
J161050	XI	8
J161060	XI	8
J162200	XI	9
J16230	XI	9
J162350	XI	9
J16240	X	19
J16240	XI	9
J162410	XI	9
J16245	XI	9
J162460	XI	9
J16250	XI	10
J16255	XI	10
J162561	XI	10
J162563	XI	10
J162565	XI	10
J16260	XI	10
J16265	XI	10
J16270	XI	11
J162702	XI	11
J16275	XI	11
J17001	XI	12
J17002	XI	12
J17003	XI	12
J170040	XI	12
J170041	XI	12
J170042	XI	12
J17005	XI	12
J17006	XI	12
J17007	XI	12
J17010	XI	12
J17012	XI	12
J17015	XI	12
J170160	XI	12
J170161	XI	12
J170162	XI	12
J17020	XI	12
J17025	XI	12
J17035	XI	12
J17045	XI	12
J17050	XI	12
J17055	XI	12
J170560	XI	12
J170561	XI	12
J170562	XI	12
J17060	XI	12
J17065	XI	12
J17070	XI	12
J170750	XI	13
J170751	XI	13
J170752	XI	13
J17080	XI	13
J17085	XI	13
J170860	XI	13
J170898	XI	13



# Index

Références References Referencias	Chapitre Chapter Capítulo	Page Page Página
J170899	XI	13
J17090	XI	13
J170901	XI	14
J170902	XI	14
J170903	XI	14
J170904	XI	14
J170905	XI	14
J170906	XI	14
J170907	XI	14
J170908	XI	14
J170940	XI	15
J17095	XI	15
J17100	XI	15
J17110	XI	15
J17115	XI	15
J171170	XI	15
J17118	XI	15
J17120	XI	15
J17130	XI	15
J17140	XI	15
J171821	XI	15
J171822	XI	15
J171823	XI	15
J171824	XI	15
J171825	XI	15
J172003	XI	15
J172004	XI	15
J172005	XI	15
J172013	XI	15
J172014	XI	15
J172015	XI	15
J172023	XI	15
J172024	XI	15
J172025	XI	15
J172803	XI	15
J172804	XI	15
J172805	XI	15
J172813	XI	15
J172814	XI	15
J172815	XI	15
J18001	XI	16
J18002	XI	16
J18003	XI	16
J18004	XI	16
J18005	XI	16
J18041	XI	16
J18042	XI	16
J18043	XI	16
J18044	XI	16
J18045	XI	16
J18103	XI	16
J18105	XI	16
J191801	XI	17
J191802	XI	17
J191803	XI	17
J191804	XI	17
J191805	XI	17
J191811	XI	17
J191812	XI	17
J191813	XI	17
J191814	XI	17
J191815	XI	17
J192003	XI	17
J192004	XI	17
J192005	XI	17
J192013	XI	17
J192014	XI	17
J192015	XI	17
J24010	XIII	9
J24020	XIII	9
J24030	XIII	9

Références References Referencias	Chapitre Chapter Capítulo	Page Page Página
J24040	XIII	9
J24050	XIII	9
J24060	XIII	9
J24070	XIII	9
J24078	XIII	9
J24080	XIII	9
J24090	XIII	9
J24100	XIII	9
J24110	XIII	9
J24120	XIII	9
J24130	XIII	9
J24140	XIII	10
J24150	XIII	10
J24160	XIII	10
J24170	XIII	10
J24180	XIII	10
J241810	XIII	10
J241811	XIII	10
J241901	XIII	11
J241902	XIII	11
J241903	XIII	11
J241904	XIII	11
J241905	XIII	11
J241906	XIII	11
J241907	XIII	11
J241908	XIII	11
J24192	XIII	12
J24193	XIII	12
J24194	XIII	12
J24195	XIII	12
J24200	XIII	12
J24215	XIII	12
J24219	XIII	13
J24220	XIII	13
J24230	XIII	13
J24240	XIII	13
J24250	XIII	13
J24260	XIII	13
J24270	XIII	13
J24280	XIII	14
J24282	XIII	14
J24284	XIII	14
J24290	XIII	14
J24300	XIII	14
J24310	XIII	14
J24320	XIII	14
J24371	XIII	15
J24372	XIII	15
J24373	XIII	15
J24374	XIII	16
J24376	XIII	16
J243770	XIII	16
J243775	XIII	16
J243776	XIII	16
J243777	XIII	16
J24378	XIII	17
J24380	XIII	17
J24390	XIII	17
J24400	XIII	17
J24405	XIII	17
J24410	XIII	17
J24415	XIII	17
J24420	XIII	17
J24425	XIII	17
J244650	XIII	18
J24470	XIII	18
J28005	XIII	19
J28010	XIII	19
J28020	XIII	19
J28030	XIII	19
J28040	XIII	19

Références References Referencias	Chapitre Chapter Capítulo	Page Page Página
J28050	XIII	19
J28060	XIII	19
J28070	XIII	19
J28080	XIII	19
J28090	XIII	19
J28110	XIII	19
J28130	XIII	19
J28150	XIII	19
J281507	XIII	19
J281508	XIII	19
J281509	XIII	19
J28151	XIII	19
J281515	XIII	19
J28152	XIII	19
J281525	XIII	19
J28153	XIII	19
J281535	XIII	19
J28155	XIII	19
J28156	XIII	19
J28157	XIII	19
J28158	XIII	19
J281620	XIII	20
J28163	XIII	20
J28170	XIII	20
J28180	XIII	20
J28190	XIII	20
J28200	XIII	20
J28210	XIII	20
J28220	XIII	20
J28230	XIII	20
J282310	XIII	20
J28232	XIII	20
J28234	XIII	20
J28236	XIII	20
J28240	XIII	20
J28250	XIII	20
J28260	XIII	20
J28270	XIII	20
J28280	XIII	20
J28290	XIII	20
J28300	XIII	20
J283100	XIII	21
J283101	XIII	21
J283102	XIII	21
J283103	XIII	21
J283104	XIII	21
J283105	XIII	21
J283106	XIII	21
J283107	XIII	21
J283108	XIII	21
J283200	XIII	22
J283201	XIII	22
J283202	XIII	22
J283203	XIII	22
J283204	XIII	22
J283205	XIII	22
J283206	XIII	22
J283207	XIII	22
J283208	XIII	22
J283210	XIII	22
J283211	XIII	22
J283212	XIII	22
J283213	XIII	22
J283214	XIII	22
J283215	XIII	22
J283216	XIII	22
J283217	XIII	22
J283218	XIII	22
J28350	XIII	23
J28360	XIII	23
J28370	XIII	23

# Index

Références References Referencias	Chapitre Chapter Capítulo	Page Page Página
J28400	XIII	23
J28402	XIII	24
J284030	XIII	24
J28404	XIII	24
J284050	XIII	24
J284060	XIII	24
J284070	XIII	24
J284080	XIII	24
J28412	XIII	24
J284130	XIII	24
J28414	XIII	24
J284150	XIII	24
J284160	XIII	24
J284170	XIII	24
J284180	XIII	24
J28420	XIII	25
J28425	XIII	25
J284260	XIII	25
J284275	XIII	25
J32010	XIII	26
J32020	XIII	26
J32030	XIII	26
J32040	XIII	26
J32050	XIII	26
J32060	XIII	26
J320800	XIII	27
J320802	XIII	27
J320803	XIII	27
J320804	XIII	27
J320805	XIII	27
J320810	XIII	27
J320812	XIII	27
J320813	XIII	27
J320814	XIII	27
J320815	XIII	27
J320990	XIII	27
J320991	XIII	27
J320992	XIII	27
J320993	XIII	27
J32100	XIII	27
J32110	XIII	27
J321101	XIII	27
J321102	XIII	27
J32140	XIII	27
J32150	XIII	27
J32160	XIII	27
J32170	XIII	27
J32190	XIII	27
J32200	XIII	27
J32210	XIII	27
J32220	XIII	27
J32235	XIII	26
J32240	XIII	28
J32250	XIII	28
J32260	XIII	28
J32270	XIII	28
J32280	XIII	28
J32290	XIII	28
J32300	XIII	28
J32310	XIII	28
J32320	XIII	28
J32330	XIII	28
J32340	XIII	28
J32350	XIII	28
J32360	XIII	28
J32370	XIII	28
J32380	XIII	28
J32390	XIII	28
J32400	XIII	28
J32410	XIII	28
J32420	XIII	28

Références References Referencias	Chapitre Chapter Capítulo	Page Page Página
J32430	XIII	29
J32440	XIII	29
J32450	XIII	29
J32460	XIII	29
J324620	XIII	31
J324621	XIII	31
J324622	XIII	31
J324623	XIII	31
J324624	XIII	31
J324625	XIII	31
J324626	XIII	31
J324627	XIII	31
J32465	XIII	30
J32470	XIII	30
J324750	XIII	30
J32480	XIII	30
J324850	XIII	30
J32490	XIII	30
J32500	XIII	30
J32510	XIII	30
J32520	XIII	30
J32530	XIII	30
J32540	XIII	30
J325420	XIII	30
J325421	XIII	30
J325422	XIII	30
J325423	XIII	30
J325424	XIII	30
J325425	XIII	30
J325426	XIII	30
J325427	XIII	30
J325428	XIII	30
J325429	XIII	30
J325430	XIII	30
J325450	XIII	30
J32550	XIII	30
J32555	XIII	30
J32560	XIII	30
J32565	XIII	30
J32570	XIII	30
J32580	XIII	30
J32590	XIII	30
J32600	XIII	30
J32610	XIII	30
J32620	XIII	30
J32621	XIII	31
J32622	XIII	31
J32623	XIII	31
J32624	XIII	31
J32625	XIII	31
J32627	XIII	33
J32628	XIII	33
J32629	XIII	33
J32630	XIII	33
J32640	XIII	33
J32650	XIII	33
J32660	XIII	33
J32665	XIII	33
J32675	XIII	23
J32678	XIII	32
J32682	XIII	32
J32684	XIII	32
J32686	XIII	32
J32688	XIII	32
J327006	XIII	34
J327008	XIII	34
J327010	XIII	34
J327012	XIII	34
J327015	XIII	34
J327020	XIII	34
J327025	XIII	34

Références References Referencias	Chapitre Chapter Capítulo	Page Page Página
J327030	XIII	34
J327106	XIII	34
J327108	XIII	34
J327110	XIII	34
J327112	XIII	34
J327115	XIII	34
J327120	XIII	34
J327125	XIII	34
J327130	XIII	34
J329010	XIII	34
J329015	XIII	34
J329020	XIII	34
J329025	XIII	34
J36020	XIII	35
J36030	XIII	35
J36040	XIII	35
J36042	XIII	35
J36044	XIII	35
J36060	XIII	35
J36070	XIII	35
J36080	XIII	35
J36100	XIII	36
J36110	XIII	36
J36120	XIII	36
J36130	XIII	36
J36140	XIII	36
J36150	XIII	36
J36180	XIII	37
J36190	XIII	37
J36200	XIII	37
J36210	XIII	37
J36220	XIII	37
J36230	XIII	37
J36240	XIII	37
J36250	XIII	37
J36260	XIII	37
J36270	XIII	37
J36280	XIII	37
J36290	XIII	37
J36300	XIII	37
J36310	XIII	37
J36320	XIII	37
J36330	XIII	37
J36335	XIII	38
J36340	XIII	38
J36345	XIII	38
J36350	XIII	39
J36360	XIII	39
J36370	XIII	39
J36380	XIII	39
J36390	XIII	39
J36400	XIII	39
J36410	XIII	39
J36420	XIII	39
J36430	XIII	39
J36440	XIII	39
J36450	XIII	39
J36460	XIII	39
J36560	XIII	40
J36570	XIII	40
J36580	XIII	40
J36590	XIII	40
J36600	XIII	40
J36620	XIII	41
J36625	XIII	41
J36635	XIII	41
J36650	XIII	23
J36700	XIII	42
J36705	XIII	42
J36710	XIII	42
J40010	XIII	43

# Index

Références References Referencias	Chapitre Chapter Capítulo	Page Page Página
J40020	XIII	43
J40025	XIII	43
J40030	XIII	43
J40040	XIII	44
J40045	XIII	44
J40050	XIII	44
J40055	XIII	44
J40060	XIII	45
J40070	XIII	45
J40075	XIII	45
J40080	XIII	45
J40090	XIII	45
J401180	XIII	46
J401190	XIII	46
J40120	XIII	46
J401300	XIII	46
J401301	XIII	46
J401302	XIII	46
J401303	XIII	46
J44005	XIII	47
J440070	XIII	47
J440075	XIII	47
J44010	XIII	47
J44020	XIII	47
J44032	XIII	47
J44035	XIII	47
J44040	XIII	47
J44045	XIII	47
J44050	XIII	47
J44055	XIII	47
J44060	XIII	47
J44065	XIII	47
J44066	XIII	47
J44068	XIII	47
J44070	XIII	47
J44071	XIII	47
J44075	XIII	48
J44085	XIII	48
J44100	XIII	48
J44105	XIII	48
J44110	XIII	48
J44115	XIII	48
J44116	XIII	48
J44117	XIII	48
J44121	XIII	49
J44122	XIII	49
J44123	XIII	49
J442008	XIII	49
J442010	XIII	49
J442012	XIII	49
J48020	XIII	50
J48030	XIII	50
J48040	XIII	50
J48050	XIII	50
J52010	VII	106
J52020	VII	106
J520230	VII	105
J520231	VII	105
J520240	VII	105
J520260	VII	105
J520280	VII	105
J52030	VII	105
J520320	VII	105
J520340	VII	105
J52040	VII	105
J520420	VII	105
J520440	VII	105
J52050	VII	104
J52060	VII	104
J52070	VII	104
J52072	VII	100

Références References Referencias	Chapitre Chapter Capítulo	Page Page Página
J52074	VII	100
J52076	VII	101
J52078	VII	101
J52082	VII	101
J52084	VII	102
J52086	VII	103
J52088	VII	103
J52092	VII	102
J52094	VII	99
J52096	VII	99
J52098	VII	99
J520990	VII	99
J52150	VII	108
J521505	VII	108
J521600	VII	108
J52170	VII	108
J52180	VII	81
J52190	VII	95
J52200	VII	95
J52205	VII	96
J52210	VII	107
J52220	VII	107
J52230	VII	107
J522400	VII	107
J538010	VII	98
J538040	VII	98
J538045	VII	98
J538050	VII	98
J538055	VII	98
J538060	VII	98
J538110	VII	98
J538140	VII	98
J538145	VII	98
J538150	VII	98
J538155	VII	98
J538160	VII	98
J538209	VII	97
J538211	VII	97
J56040	XIII	51
J56050	XIII	51
J56055	XIII	51
J56070	XIII	51
J61011	XIV	1
J61014	XIV	1
J61015	XIV	1
J61020	XIV	1
J61025	XIV	1
J61027	XIV	1
J61030	XIV	1
J61032	XIV	1
J61035	XIV	1
J61036	XIV	1
J61040	XIV	1
J61045	XIV	1
J61050	XIV	1
J61065	XIV	1
J61132	XIV	1
J61135	XIV	1
J61140	XIV	1
J61145	XIV	1
J61150	XIV	1
J61165	XIV	1
J61211	XIV	1
J61215	XIV	1
J61220	XIV	1
J61225	XIV	1
J61227	XIV	1
J61230	XIV	1
J61232	XIV	1
J61235	XIV	1
J61236	XIV	1

Références References Referencias	Chapitre Chapter Capítulo	Page Page Página
J61240	XIV	1
J61245	XIV	1
J61250	XIV	1
J61332	XIV	1
J61335	XIV	1
J61340	XIV	1
J61345	XIV	1
J61350	XIV	1
J61365	XIV	1
J64020	XIII	52
J64030	XIII	52
J64040	XIII	52
J64060	XIII	52
J64070	XIII	52
J64080	XIII	52
J64090	XIII	53
J64100	XIII	53
J64120	XIII	53
J64130	XIII	53
J64150	XIII	54
J64160	XIII	54
J64190	XIII	55
J64192	XIII	55
J64200	XIII	56
J64210	XIII	56
J64220	XIII	56
J64230	XIII	56
J64240	XIII	56
J64250	XIII	56
J64254	XIII	57
J64256	XIII	57
J64260	XIII	55
J64280	XIII	58
J64290	XIII	59
J64310	XIII	59
J64330	XIII	59
J64340	XIII	59
J64350	XIII	59
J64370	XIII	58
J64380	XIII	59
J64384	XIII	60
J643850	XIII	60
J64386	XIII	60
J64390	XIII	60
J643950	XIII	60
J64400	XIII	61
J644005	XIII	61
J64410	XIII	60
J64412	XIII	62
J64414	XIII	62
J64416	XIII	62
J64418	XIII	62
J64422	XIII	62
J64480	XIII	63
J644850	XIII	63
J64490	XIII	64
J644950	XIII	64
J644960	XIII	64
J644970	XIII	64
J644980	XIII	64
J644990	XIII	65
J644995	XIII	65
J644996	XIII	65
J645200	XIII	65
J645205	XIII	65
J68010	XIII	68
J68012	XIII	68
J68015	XIII	68
J68020	XIII	68
J68022	XIII	66
J68024	XIII	66

# Index

Références References Referencias	Chapitre Chapter Capítulo	Page Page Página
J68026	XIII	66
J68028	XIII	66
J68030	XIII	66
J68040	XIII	66
J68050	XIII	66
J68060	XIII	66
J68062	XIII	67
J68064	XIII	67
J68066	XIII	67
J68068	XIII	67
J68090	XIII	70
J68100	XIII	70
J68110	XIII	71
J68120	XIII	71
J681600	XIII	74
J681601	XIII	74
J68170	XIII	72
J68180	XIII	72
J68210	XIII	73
J68220	XIII	73
J68230	XIII	73
J68240	XIII	73
J68250	XIII	75
J68260	XIII	75
J68270	XIII	75
J68275	XIII	69
J68280	XIII	69
J72010	XIII	76
J72020	XIII	77
J72030	XIII	77
J72040	XIII	77
J72050	XIII	77
J72060	XIII	77
J72070	XIII	77
J72090	XIII	78
J72100	XIII	78
J72110	XIII	78
J72120	XIII	79
J72130	XIII	79
J72140	XIII	79
J72150	XIII	79
J72160	XIII	79
J72170	XIII	79
J72180	XIII	80
J72190	XIII	80
J721901	XIII	80
J72195	XIII	80
J72200	XIII	81
J72210	XIII	81
J72220	XIII	81
J72230	XIII	82
J72240	XIII	82
J72250	XIII	82
J72260	XIII	82
J72270	XIII	82
J72280	XIII	82
J72310	XIII	83
J72320	XIII	83
J72330	XIII	83
J72340	XIII	83
J72350	XIII	76
J72355	XIII	84
J72360	XIII	84
J72370	XIII	84
J72380	XIII	84
J72390	XIII	84
J72400	XIII	76
J72405	XIII	84
J72410	XIII	84
J72420	XIII	84
J72430	XIII	84

Références References Referencias	Chapitre Chapter Capítulo	Page Page Página
J72440	XIII	84
J72460	XIII	85
J72470	XIII	85
J72480	XIII	85
J72490	XIII	86
J72500	XIII	86
J72510	XIII	86
J725200	XIII	87
J725201	XIII	87
J725202	XIII	87
J725203	XIII	87
J725204	XIII	87
J72550	XIII	87
J72560	XIII	87
J72570	XIII	87
J72575	XIII	88
J725800	XIII	88
J725850	XIII	88
J72590	XIII	89
J72595	XIII	89
J72600	XIII	89
J72605	XIII	90
J72610	XIII	90
J72612	XIII	90
J72615	XIII	91
J72620	XIII	91
J72700	XIII	92
J72705	XIII	92
J727500	XIII	93
J731100	XIII	93
J731200	XIII	93
J732000	XIII	94
J732005	XIII	94
J732010	XIII	94
J732020	XIII	94
J733000	XIII	94
J733050	XIII	94
J733060	XIII	94
J756900	XIV	19
J757410	XIV	21
J757500	XIV	25
J757510	XIV	25
J757520	XIV	25
J757900	XIV	19
J758000	XIV	19
J758050	XIV	27
J758060	XIV	27
J758200	XIV	26
J758300	XIV	26
J758400	XIV	28
J758401	XIV	29
J758402	XIV	29
J758403	XIV	28
J758404	XIV	30
J758405	XIV	30
J758410	XIV	28
J758420	XIV	28
J758421	XIV	29
J758423	XIV	28
J758424	XIV	30
J758425	XIV	30
J758430	XIV	20
J758431	XIV	20
J759030	XIV	21
J759040	XIV	21
J759050	XIV	21
J759060	XIV	23
J759061	XIV	23
J759062	XIV	23
J759063	XIV	23
J759100	XIV	24

Références References Referencias	Chapitre Chapter Capítulo	Page Page Página
J759105	XIV	24
J759110	XIV	24
J759115	XIV	24
J76080	XV	18
J76090	XV	18
J76100	XV	18
J76110	XV	18
J76120	XV	18
J76128	XV	17
J76130	XV	17
J76140	XV	17
J80010	XIII	105
J80015	XIII	105
J80020	XIII	105
J80030	XIII	105
J80075	XIII	106
J80080	XIII	107
J80090	XIII	107
J80100	XIII	107
J80110	XIII	106
J80120	XIII	108
J80130	XIII	108
J80140	XIII	109
J80150	XIII	109
J80170	XIII	109
J80180	XIII	110
J80190	XIII	110
J80200	XIII	110
J80210	XIII	111
J80220	XIII	111
J80230	XIII	111
J80270	XIII	112
J80280	XIII	112
J80290	XIII	112
J80300	XIII	112
J80305	XIII	112
J80370	XIII	112
J80390	XIII	112
J80400	XIII	113
J80405	XIII	113
J80410	XIII	113
J80420	XIII	112
J80430	XIII	114
J80435	XIII	114
J80440	XIII	114
J80445	XIII	114
J80450	XIII	114
J804510	XIII	95
J804520	XIII	95
J804530	XIII	95
J80455	XIII	114
J80460	XIII	95
J80470	XIII	95
J80480	XIII	95
J804850	XIII	95
J804860	XIII	95
J804870	XIII	95
J80495	XIII	115
J80500	XIII	115
J805050	XIII	96
J80510	XIII	96
J80520	XIII	96
J80530	XIII	96
J805310	XIII	96
J80540	XIII	96
J80550	XIII	96
J82010	XIII	97
J82020	XIII	97
J82030	XIII	98
J82040	XIII	98
J82050	XIII	98

# Index

Références Referencias Referencias	Chapitre Chapter Capítulo	Page Page Página
J84010	XIII	99
J84020	XIII	99
J84030	XIII	99
J84040	XIII	99
J84070	XIII	100
J84110	XIII	100
J84120	XIII	100
J84130	XIII	100
J90030	XIII	101
J90040	XIII	101
J90050	XIII	101
J90060	XIII	102
J90065	XIII	102
J90070	XIII	102
J90080	XIII	101
J90090	XIII	101
J90100	XIII	101
J90110	XIII	103
J90120	XIII	103
J90130	XIII	103
J90140	XIII	103
J90150	XIII	103
J90220	XIII	104
J90230	XIII	104
J90240	XIII	104
J90250	XIII	104
J94020	XIV	35
J94030	XIV	3
J94035	XIV	3
J940410	XIV	3
J94150	XIV	31
J94160	XIV	31
J94170	XIV	31
J94180	XIV	31
J94190	XIV	31
M00010	XIV	32
M00011	XIV	32
M00012	XIV	32
M00013	XIV	32
M00014	XIV	32
M00015	XIV	32
M00016	XIV	32
M00017	XIV	32
M00018	XIV	32
M00019	XIV	32
M00020	XIV	32
M00021	XIV	32
M00022	XIV	32
M00023	XIV	32
M00024	XIV	32
M00025	XIV	32
M00026	XIV	32
M00027	XIV	32
M00028	XIV	32
M00029	XIV	32
M00030	XIV	32
M00031	XIV	32
M00032	XIV	32
M00033	XIV	32
M00034	XIV	32
M00100	XIV	32
M00101	XIV	32
M00102	XIV	32
M00103	XIV	32
M00104	XIV	32
M00105	XIV	32
M00106	XIV	32
M00107	XIV	32
M00108	XIV	32
M00109	XIV	32
M00110	XIV	32

Références Referencias Referencias	Chapitre Chapter Capítulo	Page Page Página
M00111	XIV	32
M00112	XIV	32
M00113	XIV	32
M00114	XIV	32
M00115	XIV	32
M00116	XIV	32
M00117	XIV	32
M00118	XIV	32
M00119	XIV	32
M00120	XIV	32
M00121	XIV	32
M00122	XIV	32
M00123	XIV	32
M00124	XIV	32
M00200	XIV	33
M00201	XIV	33
M00202	XIV	33
M00203	XIV	33
M00204	XIV	33
M00205	XIV	33
M00206	XIV	33
M00207	XIV	33
M00208	XIV	33
M00209	XIV	33
M00210	XIV	33
M00211	XIV	33
M00212	XIV	33
M00213	XIV	33
M00214	XIV	33
M00250	XIV	35
M00300	XIV	37
M00301	XIV	37
M00302	XIV	37
M00303	XIV	37
M00381	XIV	42
M00382	XIV	42
M00383	XIV	42
M003890	XIV	42
M004001	XIV	42
M00410	XIV	42
M00411	XIV	42
M00460	XIV	2
M00461	XIV	2
M00462	XIV	2
M004625	XIV	2
M00463	XIV	2
M00464	XIV	2
M00470	XIV	2
M00471	XIV	2
M00472	XIV	2
M00473	XIV	2
M00474	XIV	2
M00475	XIV	2
M00476	XIV	2
M00477	XIV	2
M00478	XIV	2
M00490	XIV	4
M00491	XIV	4
M00492	XIV	4
M00493	XIV	4
M00510	XIV	4
M01000	XIV	37
M01040	XIV	17
M01042	XIV	17
M01050	XIV	14
M01051	XIV	14
M01052	XIV	14
M01060	XIV	44
M01070	XIV	44
M01080	XIV	44
M01110	XIV	3

Références Referencias Referencias	Chapitre Chapter Capítulo	Page Page Página
M01111	XIV	3
M01112	XIV	3
M01120	XIV	5
M01122	XIV	5
M01124	XIV	5
M01126	XIV	5
M01128	XIV	5
M01130	XIV	5
M01132	XIV	6
M01134	XIV	6
M01136	XIV	6
M01138	XIV	6
M01140	XIV	6
M01150	XIV	6
M01160	XIV	6
M01170	XIV	6
M01175	XIV	6
M01176	XIV	6
M01177	XIV	6
M01200	XIV	7
M01210	XIV	7
M01220	XIV	7
M01230	XIV	7
M01235	XIV	7
M01240	XIV	7
M01241	XIV	7
M01250	XIV	14
M01251	XIV	14
M01252	XIV	14
M01253	XIV	14
M01260	XIV	17
M01270	XIV	17
M02000	XIV	36
M02001	XIV	36
M02002	XIV	36
M02003	XIV	36
M02010	XIV	36
M02020	XIV	36
M02021	XIV	36
M02030	XIV	38
M02040	XIV	38
M02050	XIV	38
M02070	XIV	40
M02071	XIV	40
M02072	XIV	40
M02080	XIV	39
M02090	XIV	39
M02091	XIV	39
M02092	XIV	39
M02100	XIV	46
M02110	XIV	46
M02120	XIV	46
M02122	XIV	47
M02124	XIV	47
M02126	XIV	47
M02130	XIV	11
M02140	XIV	11
M02150	XIV	13
M02170	XIV	35
M02190	XIV	35
M02200	XIV	4
M02215	XIV	11
M02220	XIV	11
M02230	XIV	11
M02235	XIV	11
M02240	XIV	13
M02241	XIV	13
M02270	XIV	18
M02271	XIV	18
M02272	XIV	18
M02273	XIV	18

# Index

Références References Referencias	Chapitre Chapter Capítulo	Page Page Página
M02274	XIV	18
M02275	XIV	18
M03001	XIV	41
M03002	XIV	41
M03010	XIV	45
M03011	XIV	45
M03012	XIV	45
M03020	XIV	4
M03022	XIV	4
M03024	XIV	4
M03030	XIV	12
M03031	XIV	12
M03032	XIV	12
M03033	XIV	12
M03034	XIV	13
M03035	XIV	13
M03036	XIV	13
M03037	XIV	13
M03040	XIV	41
M03050	XIV	40
M03060	XIV	4
M03110	XIV	15
M03120	XIV	15
M03125	XIV	15
M03126	XIV	15
M03130	XIV	16
M03135	XIV	16
M03170	XIV	19
M03200	XIV	34
M03201	XIV	34
M03202	XIV	34
M03203	XIV	34
M03210	XIV	37
M03211	XIV	37
M03212	XIV	37
M03213	XIV	37
M03220	XIV	38
M03240	XIV	34
M03241	XIV	34
M03250	XIV	34
M03280	XIV	34
M03290	XIV	34
M03291	XIV	34
M03320	XIV	39
M03321	XIV	39
M03340	XIV	43
M03350	XIV	43
M03355	XIV	43
M03356	XIV	43
M03357	XIV	43
M03360	XIV	45
M03361	XIV	45
M03362	XIV	45
M03380	XIV	8
M03381	XIV	8
M03382	XIV	8
M03390	XIV	8
M03391	XIV	8
M03392	XIV	8
M03393	XIV	8
M03400	XIV	8
M03410	XIV	9
M03420	XIV	9
M03422	XIV	9
M03430	XIV	9
M03431	XIV	9
M03432	XIV	9
M03433	XIV	9
M03435	XIV	9
M03436	XIV	9
M03437	XIV	9

Références References Referencias	Chapitre Chapter Capítulo	Page Page Página
M03438	XIV	9
M03440	XIV	12
M03450	XIV	10
M03460	XIV	10
M03470	XIV	10
M03480	XIV	10
M03490	XIV	10
M03500	XIV	17
M03510	XIV	17
M03520	XIV	14
M03530	XIV	14
M03600	XIV	19
M03700	XIV	48
M03710	XIV	48
M03745	XIV	48
M03770	XIV	48
O05050	XV	22
O05070	XV	22
O05080	XV	22
O10050	XV	22
O10070	XV	22
O10080	XV	22
O10150	XV	22
O10200	XV	22
O10270	XV	22
O10310	XV	22
O10400	XV	22
O10490	XV	22
P15055	XV	20
P15060	XV	20
P20010	XV	20
P20015	XV	20
P35010	XV	21
P35020	XV	21
P35030	XV	21
P35040	XV	21
P35050	XV	21
P35060	XV	21
P35070	XV	21
P35080	XV	21
P35090	XV	21
P35100	XV	21
P45010	XV	21
P45020	XV	21
P45030	XV	21
P75010	XV	21
P75020	XV	21
P75030	XV	21
P75050	XV	21
P75060	XV	21
P75070	XV	21
P75080	XV	21
P75090	XV	21
P75110	XV	21
P75120	XV	21
P75125	XV	21
P75130	XV	21
T90090	XV	19
T90095	XV	19
T90098	XV	19
T90100	XV	19
T90110	XV	19
T90120	XV	19
T90130	XV	19
T90140	XV	19
T90141	XV	19
T90143	XV	19
T90145	XV	19
V02210	XV	27
V02220	XV	27
V02230	XV	27

Références References Referencias	Chapitre Chapter Capítulo	Page Page Página
V02260	XV	27
V02265	XV	27
V02270	XV	27
V025650	XV	24
V02570	XV	24
V02575	XV	24
V02580	XV	24
V02610	XV	25
V02620	XV	25
V02630	XV	25
V02640	XV	25
V02650	XV	25
V02660	XV	25
V028000	XV	24
V028001	XV	24
V035110	XV	26
V035115	XV	26
V036000	XV	25
V78070	XV	30
V78090	XV	28
V78100	XV	28
V78110	XV	28
V781150	XV	28
V78120	XV	28
V78130	XV	29
V78150	XV	29
V78170	XV	28
V78300	XV	30
V78320	XV	30
V784000	XV	30

# Index alphabétique

## A

<b>ABADIE</b>	ECARTEUR	VII - 69
<i>ABAISSÉ-LANGUE</i>		XV - 3
<b>ABOULKER</b>	DILATATEUR ORL	XII - 6
	ECARTEUR	VII - 15
	SPATULE DISSECTEUR	XI - 10
<b>ADLERKREUTZ</b>	PINCE A DISSECTION	II - 11, 39
<b>ADSON</b>	ECARTEUR POUR HEMILAMINECTOMIE	VII - 94
	PINCE A DISSECTION	II - 17, 35 et XV - 12
<b>ADSON BROWN</b>	PINCE A DISSECTION	II - 18
<i>AGRAFES A SUTURES</i>		VI - 4
<i>AIGUILLE A CORPS ETRANGERS</i>		XII - 14
<i>AIGUILLE A EPILER</i>		XV - 26
<i>AIGUILLE A LIGATURES</i>		VI - 21, 22, 24
<i>AIGUILLE A PARACENTHESE</i>		XII - 14
<i>AIGUILLE A ROTULE</i>		XIII - 115
<i>AIGUILLE A SUTURES</i>		VI - 20, 23
<i>AIGUILLE PASSE-FIL</i>		VI - 22
<i>AIGUILLE POUR POSE DES DRAINS</i>		VI - 23
<b>ALAN PARKS</b>	ECARTEUR ANAL ET VALVE	VIII - 28
<i>ALESOIR A MAIN</i>		XIV - 35
<i>ALESOIR FLEXIBLE MEDULLAIRE</i>		XIV - 32
<i>ALESOIR RIGIDE MEDULLAIRE</i>		XIV - 33
<i>ALESOIR RIGIDE POUR CLOUS</i>		XIV - 37
<b>ALLAINE</b>	CISEAUX A DISSECTION	III - 16, 17
	PASSE-FIL - DISSECTEUR	IV - 45
<b>ALLAIRE</b>	CISEAUX DELICATS	III - 6
<b>ALLIS</b>	PINCE A PREHENSION	IV - 73
<b>ALM</b>	ECARTEUR	VII - 77
<b>AMERICAIN</b>	ETRIER ET CROCHET	XIII - 103
<i>AMNIOSCOPE METAL</i>		VIII - 29
<i>AMNIOSCOPE PLEXIGLAS</i>		VIII - 29
<i>AMPLIFICATEUR POUR GREFFE DE PEAU</i>		I - 8
<i>AMYGDALOTOME</i>		XII - 18
<b>ANDREW PYNCHON</b>	CANULE D'ASPIRATION	XV - 23
<i>ANSE ORL</i>		XII - 38
<i>ANUSCOPE</i>		VIII - 24
<i>ARRACHE CLOU ET CROCHET</i>		XIV - 36
<b>ARRUGA</b>	PINCE CAPSULAIRE	X - 11
<i>ATELLE MALLEABLE</i>		XV - 19
<b>AUBRY</b>	ECARTEUR EN Z	XII - 36
<b>AUFRICT</b>	RAPE ORL	XII - 30
<b>AUVERT</b>	CADRE, VALVES, FERS, ETAU ET VIS	VII - 64
	PINCE CLAMP	IV - 70
<b>B</b>		
<b>BABCOCK</b>	PINCE A PREHENSION	IV - 76
<b>BABINSKY</b>	MARTEAU A REFLEXES ET CAOUTCHOUC	XV - 1
<b>BABY-ADSON</b>	PASSE-FIL - DISSECTEUR	IV - 40
<b>BABY-ALLIS</b>	PINCE A PREHENSION	IV - 74
<b>BABY-CRILE-WOOD</b>	PORTE-AIGUILLES	VI - 9
<b>BABY-DOYEN</b>	PINCE CLAMP GASTRO INTESTINALE	IV - 58
<b>BABY-LEXER</b>	CISEAUX A DISSECTION	III - 12
<b>BABY-METZENBAUM</b>	CISEAUX A DISSECTION	III - 51
<b>BABY-MIKULICZ</b>	PINCE HEMOSTATIQUE SPECIALE	IV - 32
<b>BABY-SENN-MILLER</b>	ECARTEUR	VII - 20
<b>BACKHAUS</b>	PINCE A CHAMPS	IV - 79, 80 et XV - 15
<b>BAILLEY</b>	RAPPROCHEUR DE COTES	VII - 76
<b>BAINBRIDGE</b>	PINCE CLAMP ATRAUMA	V - 6
	PINCE HEMOSTATIQUE SPECIALE	IV - 29
<b>BAKES</b>	DILATATEUR POUR VOIES BILIAIRES	IX - 10
<b>BALFOUR</b>	ECARTEUR ET VALVE	VII - 67
<b>BALFOUR-BABY</b>	ECARTEUR	VII - 67
<b>BALLENGER</b>	GOUGE ORL	XII - 26
<i>BANDE EN CAOUTCHOUC</i>		XV - 2
<b>BAR</b>	CLAMP OMBILICAL ET PINCE A COUPER LES CLAMPS	VIII - 50
	ECARTEUR ANAL	VIII - 27
<b>BARRAQUER</b>	MICRO PORTE-AIGUILLES	X - 4
<b>BARRAYA</b>	PASSE-FIL - SEPARATEUR	IV - 53
	PINCE A DISSECTION	II - 9, 10, 39
<i>BARRE DE LIAISON POUR FORCEPS</i>		VIII - 20
<b>BECK</b>	PINCE CLAMP ATRAUMA	V - 14
<b>BECKMANN</b>	COUTEAU A VEGETATIONS	XII - 15
	ECARTEUR	VII - 82 à 85
	ECARTEUR, GRIFFES ET VALVES DEMONTABLES	VII - 86, 87
<b>BECKMANN CONE</b>	ECARTEUR	VII - 82 à 84
<b>BEEBEE</b>	CISEAUX COUPE-FILS	III - 20
<b>BENGOLEA</b>	PINCE HEMOSTATIQUE LONGUE	IV - 24, 25, 88

## Index alphabétique

<b>BENNET</b>	ECARTEUR	VII - 106
<b>BENSAUDE</b>	ANUSCOPE	VIII - 24
<b>BENSON</b>	PINCES DIVERSES	IV - 77
<b>BERGER</b>	PINCE A BIOPSIE UTERINE	VIII - 38
<b>BERGMANN</b>	CROCHET	VII - 17
<b>BESNIER</b>	CURETTE DERMATO	XIII - 24
<b>BEYER</b>	PINCE GOUGE	XIII - 60
<b>BEYER-ZAUFAL</b>	PINCE GOUGE	XIII - 63
<b>BILLEAU</b>	ANSE ORL	XII - 38
<b>BIRCHER</b>	PINCE A MENISQUE	XIII - 109
<i>BISTOURI</i>		I - 1
<i>BISTOURI COUPE-FILS STERILE</i>		I - 5
<i>BISTOURI STERILE</i>		I - 5
<b>BLUMENTHAL</b>	PINCE GOUGE	XIII - 65
<i>BOCK A DOUCHE</i>		XV - 20
<b>BOEHLER</b>	ETRIER ET CAVALIER	XIII - 104
	PINCE COUPANTE	XIII - 68
	PINCE GOUGE	XIII - 60
	CISEAUX DIVERS	III - 25
<b>BOETCHER</b>		
<i>BOITE DE STERILISATION ALU</i>		XV - 22
<i>BOITE DE STERILISATION INOX</i>		XV - 22
<b>BONNAIRE</b>	PINCE A FAUX GERMES	VIII - 17
<b>BONNIOT</b>	PINCE HEMOSTATIQUE	IV - 15
<b>BORDIER-MEUNIER</b>	TROCARD POUR BIOPSIE OSSEUSE	XV - 25
<i>BOUGIE DILATATRICE POUR L'URETRE</i>		IX - 9
<b>BOURGEOIS</b>	PINCE A PREHENSION ORL	XII - 7
<i>BOUTON POUR CADRE</i>		VII - 63
<b>BOZEMANN</b>	PINCE A PANSEMENTS	VIII - 3
	PINCE HEMOSTATIQUE LONGUE	IV - 39
<b>BRAND</b>	PINCE A TENDONS	XIII - 3
<b>BRAUN-STADLER</b>	CISEAUX A EPISIOTOMIE	VIII - 66
<b>BRIESKY</b>	VALVE VAGINALE	VIII - 47
<i>BROCHE GUIDE POUR VIS PERFOREE</i>		XIV - 43
<b>BROCK</b>	GRATTOIR DERMATO	XIII - 25
<b>BROWN RESANO</b>	PINCE A DISSECTION	II - 14
<b>BRUNNER</b>	ECARTEUR	VII - 33
<b>BRUNS</b>	CISEAUX POUR PLATRES	XV - 17
	CURETTE OSSEUSE	XIII - 21, 22
<b>BUCK</b>	PINCE A CORPS ETRANGERS	X - 15
<b>BUCK-GRAMCKO</b>	LEVIER A OS	VII - 99
<i>BURIN</i>		XIII - 26 à 34
<i>BURIN ORL</i>		XII - 24, 25
<i>BURIN PORTE-LAME - MANCHE, LAME ET CLE</i>		XIV - 18
<b>BUSCH</b>	CISEAUX	VIII - 65
<b>C</b>		
<i>CADRE (ECARTEUR)</i>		VII - 60 à 64 et XIII - 94
<i>CADRE SUPPORT INSTRUMENTS</i>		XV - 29
<b>CAIRNS (CLOVIS-VINCENT)</b>	SPATULE DECOLLE DURE MERE	XI - 2
<i>CANON POUR VISEUR DE GENOU</i>		XIII - 110
<i>CANULE A HYSTEROGRAPHIE</i>		VIII - 58
<i>CANULE - ROBINET - TUYAU</i>		XV - 20
<i>CANULE A HEPARINE</i>		XV - 24
<i>CANULE D'ASPIRATION</i>		XV - 23
<i>CANULE ORL</i>		XII - 40
<i>CANULE POUR SERRE-NŒUD</i>		XII - 13
<i>CAOUTCHOUC POUR MARTEAU A REFLEXE</i>		XV - 1
<i>CAPUCHON POUR ECARTEUR</i>		VII - 59
<b>CARPENTIER</b>	SPATULE DISSECTEUR	XI - 11
<b>CARREL</b>	CLAMP POUR LYMPHOGRAPHIE	V - 3
<b>CASTANEDA</b>	PINCE CLAMP ATRAUMA - PEDIATRIE	V - 28
<b>CASTROVIEJO</b>	MICRO PORTE-AIGUILLES	X - 1, 2
	PORTE-LAME	X - 20
<b>CAUCHOIX</b>	ECARTEUR	VII - 107
	GOUGE	XIII - 39
	OSTEOTOME	XIII - 33
<i>CAVALIER POUR ETRIER</i>		XIII - 104
<i>CHAINE AVEC CURSEUR</i>		VII - 51
<i>CHAINE POUR ECARTEUR</i>		VII - 59
<i>CHAINE POUR PIQUET</i>		VII - 51
<b>CHAPUT</b>	PINCE A PREHENSION	IV - 72
<b>CHAPUT-MAYO</b>	PINCE A PREHENSION	IV - 72
<b>CHARNLEY</b>	CADRE ET VALVES	XIII - 94
	CURETTE OSSEUSE	XIII - 23
<b>CHARRIERE</b>	SCIE A AMPUTATION ET LAME	XIII - 5
<i>CHASSE-GREFFON</i>		XIII - 95, 96
<b>CHATELIER</b>	PINCE A PREHENSION ORL	XII - 7
<i>CHAUSSE VEINE</i>		VII - 17



## Index alphabétique

<b>CHERON</b>	PINCE A PANSEMENTS	VIII - 1
<b>CHEVALIER-JACKSON</b>	PINCE POUR OESOPHAGOSCOPIE	XII - 23
<b>CHIGOT</b>	ECARTEUR	VII - 11
<b>CHRISTOPHE</b>	PINCE HEMOSTATIQUE	IV - 22, 90
<b>CHROBAK</b>	PINCE UTERINE	VIII - 14
CISAILLE		XIII - 67
CISAILLE ORL		XII - 22
CISEAU CONDUCTEUR POUR PLAQUES		XIV - 11, 13
CISEAU ORL		III - 56 et XII - 35
CISEAU POUR LE GENOU		XIII - 114
CISEAUX A DECAPSULER		XIII - 92
CISEAUX A DISSECTION		III - 7 à 17, 42 à 51 et XV - 11, 12
CISEAUX A ENUCLEATION		III - 5
CISEAUX A EPISIOTOMIE		VIII - 66, 67
CISEAUX A IRIDECTOMIE		III - 4, 52 et XV - 11
CISEAUX A MENISQUE		XIII - 109
CISEAUX A ONGLES		XV - 6, 10
CISEAUX A PANSEMENT		III - 19, 47 et XV - 11
CISEAUX A STRABISME		III - 4
CISEAUX COIFFEUR		III - 37
CISEAUX COLLEUR		III - 37
CISEAUX COUPE-FILS		III - 20, 47
CISEAUX COUTURIERE		III - 38
CISEAUX DAUPHIN		III - 3 et XV - 11
CISEAUX DELICATS		III - 5, 6, 52
CISEAUX DIVERS		III - 18, 25, 34, 39, 49 et VIII - 65
CISEAUX EN S		III - 34
CISEAUX ENTEROTOME		XIII - 8
CISEAUX FINS		III - 26, 29 à 31, 41, 52, 53
CISEAUX LONGS ET FINS		III - 31 à 33, 46, 53
CISEAUX MOUSSES		III - 1, 41 et XV - 11
CISEAUX PINCE		VI - 18
CISEAUX POINTUS		III - 2, 41 et XV - 11
CISEAUX POUR CORDON OMBILICAL		VIII - 65
CISEAUX POUR COTON		III - 39
CISEAUX POUR FISTULE		III - 33
CISEAUX POUR LOBECTOMIE		III - 35
CISEAUX POUR PLATRES		XV - 17
CISEAUX PRESTIGE		III - 52 à 56
CISEAUX UNIVERSELS		III - 40
CISEAUX UTERINS		III - 36, 49, 56
CISEAUX VAGINAUX		VIII - 67
CISEAUX VASCULAIRES		III - 21 à 24, 54, 55
<b>CITELLI</b>	EMPORTE PIECES O.R.L.	XII - 19
CLAMP BULLDOG		V - 1 à 3
CLAMP DISSECTEUR		VIII - 10
CLAMP OMBILICAL		VIII - 50
CLAMP PLASTIQUE		XV - 16
CLAMP POUR LYMPHOGRAPHIE		V - 3
<b>CLAQUE</b>	RETRACTEUR ORL	XII - 36
CLE A CARDAN		XIV - 17
CLE DE SERRAGE POUR ETRIER		XIII - 101
CLE MIXTE		XIV - 17
CLE PLATE		XIII - 102 et XIV - 17
CLE POUR MANDRIN		XIV - 3
<b>CLOVIS-VINCENT</b>	CURETTE ORL	XII - 38
	FRAISE	XI - 7
	RUGINE A SCIATIQUE	XI - 1
	SPATULE NEURO	XI - 3
<b>CLOWARD</b>	ECARTEUR	VII - 96, 97
	ECARTEUR ET VALVES	VII - 98
<b>COBB</b>	GOUGE	XIII - 42
	RUGINE	XIII - 16
<b>COLLIN</b>	COSTOTOME	XIII - 72
	PINCE A PREHENSION	IV - 69
	SPECULUM VAGINAL	VIII - 30 à 32
<b>COLVER</b>	PINCE A PREHENSION ORL	XII - 10
COMPAS (ECARTEUR)		VII - 47, 52, 57
COMPRESSEUR POUR L'URETRE		IX - 8
CONDUCTEUR POUR FIL SCIE		XIII - 7
<b>COOLEY</b>	PINCE A DISSECTION	II - 34
	PINCE CLAMP ATRAUMA - ANASTOMOSE	V - 25, 26
	PINCE CLAMP ATRAUMA - COARCTATION	V - 24, 25
	PINCE CLAMP ATRAUMA - LIGATURES	V - 25
	PINCE CLAMP ATRAUMA - PEDIATRIE	V - 26, 27
	PINCE CLAMP ATRAUMA - USAGES MULTIPLES	V - 24
COSTOTOME		XIII - 72 à 75

## Index alphabétique

<b>COTT</b>	COMPAS ET VALVES	VII - 57
	PINCE A LAMBEAUX	VIII - 14
<b>COTTLE</b>	BURIN ORL	XII - 24
	CROCHET ORL	XII - 31
	RAPE ORL	XII - 29
	<i>COURONNE TREPAN</i>	XI - 7
	<i>COUTEAU A AMPUTATION</i>	XIII - 4
	<i>COUTEAU A CERVEAU</i>	XIII - 8
	<i>COUTEAU A VEGETATIONS</i>	XII - 15, 16
<b>CRABE</b>	PINCE A CHAMPS	IV - 78
<b>CRAFOORD</b>	CISEAUX POUR LOBECTOMIE	III - 35
<b>CRAFOORD (SELLORS)</b>	PINCE HEMOSTATIQUE SPECIALE	IV - 30
<b>CREED</b>	SPATULE POUR SCIATIQUE	XI - 2
<b>CRILE</b>	CROCHET NEURO	XI - 9
	PINCE HEMOSTATIQUE	IV - 19, 90
<b>CRILE-WOOD</b>	PORTE-AIGUILLES	VI - 9 et XV - 13
	<i>CROCHET</i>	VII - 17, 18 et XIII - 50, 101 à 103
	<i>CROCHET A DURE MERE</i>	XI - 1
	<i>CROCHET A MENISQUE</i>	XIII - 112
	<i>CROCHET A PHLEBECTOMIE</i>	V - 29
	<i>CROCHET A TENDONS</i>	XIII - 2
	<i>CROCHET D'EXTRACTION</i>	XIV - 36
	<i>CROCHET EXPLORATEUR</i>	XIII - 112
	<i>CROCHET NETTOYAGE TETES DE VIS</i>	XIV - 4
	<i>CROCHET NEURO</i>	XI - 9
	<i>CROCHET ORL</i>	XII - 31, 34
	<i>CUPULE A BEC</i>	XV - 21
	<i>CURETTE A SCIATIQUE</i>	XI - 1
	<i>CURETTE DERMATO</i>	XIII - 24
	<i>CURETTE ORL</i>	XII - 38, 39
	<i>CURETTE OSSEUSE</i>	XIII - 19 à 23
	<i>CURETTE POUR VOIES BILIAIRES</i>	IX - 6
	<i>CURETTE UTERINE</i>	VIII - 52 à 57
	<i>CURSEUR POUR CHAINE</i>	VII - 51
	<i>CURSEUR POUR HYSTEROMETRE</i>	VIII - 64
<b>CUSCO</b>	SPECULUM VAGINAL	VIII - 33
<b>CUSHING</b>	CROCHET NEURO	XI - 9
	ECARTEUR	VII - 16
	ECARTEUR A DECOMPRESSION	VII - 20
	MICRO CROCHET	X - 19
	PINCE A DISSECTION	II - 19, 36
	PINCE RONGEUR A LAMINECTOMIE	XI - 12
	SPATULE NEURO	XI - 4
	<i>CUVETTE RENIFORME HARICOT</i>	XV - 21
	<i>CYLINDRE VERRE POUR SERINGUE</i>	XV - 27
<b>CZERNY</b>	PINCE A PREHENSION UTERINE	VIII - 15
<b>D</b>		
<b>DALE</b>	PINCE CLAMP ATRAUMA - PERIPHERIQUE	V - 21
<b>DANDY</b>	MICRO CROCHET	X - 19
	PINCE HEMOSTATIQUE	IV - 17
<b>DANIS</b>	ECARTEURS	XIII - 99
	PASSE-FIL TUBULAIRE POUR CERCLAGE	XIII - 100
	REFOULOIR	XIII - 100
	SPATULE	XIII - 99
	TENDEUR	XIII - 93
<b>DARGENT</b>	CLAMP DISSECTEUR	VIII - 10
	VALVE VAGINALE	VIII - 48
<b>DARTIGUES</b>	LAPAROSTAT	VII - 70
	PINCE HYSTEROLABLE	VIII - 18
<b>DAUTREY</b>	ECARTEUR ORL	XII - 36
<b>DAVID</b>	PINCE GOUGE	XIII - 58
	<i>DAVIER</i>	XIII - 76 à 91
	<i>DAVIER A POINTES</i>	XIII - 88
	<i>DAVIER A RESECTION</i>	XIII - 78
	<i>DAVIER AUTO-CENTREUR</i>	XIII - 87
	<i>DAVIER DENTS DE LION</i>	XIII - 78
	<i>DAVIER POUR OS DE LA MAIN</i>	XIII - 76
	<i>DAVIER POUR PETITS FRAGMENTS</i>	XIII - 88
<b>DAVIS</b>	SPATULE POUR DURE MERE	XI - 9
<b>DAVIS-BOYLE</b>	OUVRE-BOUCHE ET PROTECTIONS	XII - 4
<b>DEBAKEY</b>	CISEAUX VASCULAIRES	III - 22
	CLAMP BULLDOG	V - 1
	PINCE A DISSECTION	II - 33, 34
	PINCE CLAMP ATRAUMA	V - 5, 14, 18, 19, 23
	PINCE CLAMP ATRAUMA - ANEVRISEME AORTE	V - 7, 8
	PINCE CLAMP ATRAUMA - AORTE	V - 11, 12
	PINCE CLAMP ATRAUMA - ARTERE RENALE	V - 7

## Index alphabétique

<b>DEBAKEY</b>	PINCE CLAMP ATRAUMA - LIGATURES	V - 5, 11, 12
	PINCE CLAMP ATRAUMA - USAGES MULTIPLES	V - 15
	PORTE-AIGUILLES	VI - 13
<b>DEBAKEY-BAHNSON</b>	PINCE CLAMP ATRAUMA - ANEURISME ARTERE	V - 16
<b>DEBAKEY-CAROTID</b>	CLAMP BULLDOG	V - 2
<b>DEBAKEY-FINE</b>	PORTE-AIGUILLES	VI - 13
<b>DEBAKEY-GLOVER</b>	CLAMP BULLDOG	V - 1
<b>DEBAKEY-MOSQUITO</b>	PINCE CLAMP ATRAUMA	V - 18
<b>DEBAKEY-PEAN</b>	PINCE CLAMP ATRAUMA	V - 17
<b>DEBAKEY-POTTS</b>	PINCE CLAMP ATRAUMA - ANASTOMOSE	V - 4
	PINCE CLAMP ATRAUMA - COARCTATION	V - 4
<b>DEBAKEY-RANKIN</b>	PINCE CLAMP ATRAUMA	V - 18
<b>DEBAKEY-SATINSKY</b>	CLAMP BULLDOG	V - 2
<b>DE MARTEL</b>	CISEAUX VASCULAIRES	III - 24
	CONDUCTEUR POUR FIL SCIE	XIII - 7
	DISSECTEUR NEUROCHIRURGIE	XI - 9
	PINCE A PREHENSION	IV - 63
<b>DEAVER</b>	ECARTEUR	VII - 42, 43
<i>DECOLLEUR A TENDONS</i>		XIII - 1
<b>DECOULX</b>	ECARTEUR	VII - 88
<b>DELESTRE</b>	CISEAUX A EPISIOTOMIE	VIII - 66
<b>DEMLIN-SUZOR</b>	FORCEPS ET ACCESSOIRES	VIII - 20
<b>DEMOISELLE</b>	CHASSE-GREFFON	XIII - 95
<b>DENIS-BROWN</b>	CADRE ET VALVES	VII - 62
<i>DERMATOME A MAIN</i>		I - 6, 7
<b>DERRA</b>	PINCE CLAMP ATRAUMA - ANASTOMOSE	V - 20
<b>DESCHAMPS</b>	AIGUILLE A LIGATURES	VI - 24
<b>DESCHAMPS-SCHAUTA</b>	AIGUILLE A LIGATURES	VI - 24
<b>DESGOUTTES</b>	PINCE A DISSECTION	II - 14
<b>DESJARDINS</b>	CURETTE POUR VOIES BILIAIRES	IX - 6
	DRAGUE POUR VOIES BILIAIRES	IX - 6
	EXPLORATEUR POUR VOIES BILIAIRES	IX - 6
	PINCE POUR VOIES BILIAIRES	IX - 3, 5
<b>DESMARETS</b>	ECARTEUR - VALVES	VII - 50
<b>DESMARRES</b>	ECARTEUR	VII - 15, 17
<b>DIETRICH</b>	PINCE CLAMP ATRAUMA - AORTE	V - 9
<b>DIGMANN</b>	DAVIER	XIII - 80
<i>DILATATEUR ANAL</i>		VIII - 25
<i>DILATATEUR ORL</i>		XII - 6
<i>DILATATEUR POUR VOIES BILIAIRES</i>		IX - 10
<i>DILATATEUR TRACHEO</i>		XII - 5
<i>DILATATEUR UTERIN</i>		VIII - 61 à 63
<i>DISSECTEUR (SPATULE)</i>		XIII - 17
<b>DIXON-LOVELACE</b>	PINCE HEMOSTATIQUE	IV - 18
<b>DOUAY</b>	PINCE A BIOPSIE UTERINE	VIII - 38
<b>DOUGLAS</b>	VALVE VAGINALE	VIII - 46
<i>DOUILLE DE CENTRAGE POUR MECHE</i>		XIV - 9
<i>DOUILLE PROTECTRICE POUR VIS PERFOREE</i>		XIV - 43
<b>DOYEN</b>	AIGUILLE	VI - 21
	CISEAUX	III - 18
	COSTOTOME	XIII - 75
	OUVRE-BOUCHE	XII - 2
	PERFORATEUR, COURONNE ET FRAISES	XI - 7
	PINCE A CHAMPS	IV - 78
	PINCE A OVAIRES	VIII - 17
	PINCE CLAMP GASTRO INTESTINALE	IV - 59
	PINCE COPROSTASE	IV - 57
	PORTE-AIGUILLES	VI - 5
	RUGINE COSTALE	XIII - 10
	TRACTEUR POUR FIBROME	VIII - 49
	VALVE VAGINALE	VIII - 42
<b>DOYEN-ROCHARD</b>	VALVE	VII - 49
<b>DR BARRE</b>	PINCE POUR VOIES BILIAIRES	IX - 5
<i>DRAGUE POUR VOIES BILIAIRES</i>		IX - 6
<b>DUBOIS</b>	CISEAUX UTERINS	III - 36
<b>DUBOST</b>	CISEAUX A DISSECTION	III - 11, 48
	ECARTEUR	VII - 75
<b>DUFOURMENTEL</b>	RAPE ORL	XII - 28
<b>DUMONT</b>	PINCE A DISSECTION MICRO	II - 28
<b>DUPLAY</b>	SPECULUM NASAL	XII - 11
<b>DUPONT</b>	OSTEOTOME	XIII - 32
<b>DURAND</b>	PINCE A DISSECTION	II - 12, 40
<b>DUVAL</b>	PINCE A DISSECTION	II - 16
	PINCE A PREHENSION	IV - 67, 68
<b>E</b>		
<i>ECARTEUR A DECOMPRESSION</i>		VII - 18
<i>ECARTEUR A RACINE</i>		VII - 12

# Index alphabétique

<i>ECARTEUR ANAL</i>		VIII - 27, 28
<i>ECARTEUR EN Z</i>		XII - 36
<i>ECARTEUR HEMILAMINECTOMIE</i>		VII - 93, 94
<i>ECARTEUR ORL</i>		XII - 36
<i>ECARTEUR POUR AVANT-BRAS</i>		VII - 106
<i>ECARTEUR POUR EPAULE</i>		XIII - 111
<i>ECARTEUR POUR EPAULE (BANKART)</i>		XIII - 97, 98
<i>ECARTEUR POUR GENOU</i>		XIII - 106, 107
<i>ECARTEUR POUR GOITRE</i>		VII - 89
<i>ECARTEUR POUR VOIES BILIAIRES</i>		IX - 7
<i>ECARTEUR VALVES MALLEABLES</i>		XII - 10
<i>ECARTEURS DIVERS</i>		VII - 1 à 108 et XIII - 99
<b>ECHLIN</b>	PINCE GOUGE	XIII - 57
<i>ELEVATEUR A META</i>		VII - 99
<i>ELEVATEUR ORL</i>		XII - 32, 33, 35
<b>EMMET</b>	AIGUILLE	VI - 22
<i>ENDOSPECULUM</i>		VIII - 36
<b>ENEMA</b>	POIRE	XV - 28
<i>EPINGLE POUR INSTRUMENTS</i>		XV - 28
<b>ESMARCH</b>	BANDE EN CAOUTCHOUC	XV - 2
<i>ETALON D'ANGLE POUR PLAQUES</i>		XIV - 12, 13
<i>ETAU POUR CADRE</i>		VII - 64
<i>ETRIER</i>		XIII - 101 à 104
<b>EUFRATE</b>	PORTE-AIGUILLES	VI - 16
<b>EUFRATE-PASQUE</b>	PORTE-AIGUILLES	VI - 15
<b>EVANS</b>	PINCE A DISSECTION	II - 36
<i>EXPLORATEUR POUR VOIES BILIAIRES</i>		IX - 6
<i>EXTRACTEUR EN T</i>		VII - 108
<i>EXTRACTEUR POUR AGRAFES</i>		XIV - 46
<i>EXTRACTEUR POUR CLOUS</i>		XIV - 38
<b>F</b>		
<b>FARABEUF</b>	BISTOURI	I - 1
	BURIN	XIII - 27
	DAVIER	XIII - 77
	ECARTEUR	VII - 1, 2
	GOUGE	XIII - 40
	RUGINE	XIII - 9
	SCIE ET LAMES	XIII - 6
<b>FARABEUF-CORTI</b>	ECARTEUR	VII - 3
<b>FARKAS</b>	PINCE A DISSECTION	II - 15
<b>FAURE (J.L)</b>	PINCE A BIOPSIE	VIII - 40
	PINCE A DISSECTION	II - 13
	PINCE A LIGAMENT	VIII - 12
	PINCE A PLATEAUX	VIII - 12
	PINCE POUR ARTERE UTERINE	VIII - 11
<i>FAUX POUR AMYGDALECTOMIE</i>		XII - 17
<b>FEILCHENFELD</b>	PINCE A ECHARDES	II - 28
<i>FER A CINTRER LES CLOUS</i>		XIV - 37
<i>FER A CINTRER LES PLAQUES</i>		XIV - 14
<i>FER A CINTRER LES VALVES</i>		VII - 64
<b>FERRIS-SMITH-CUSHING</b>	PINCE RONGEUR A LAMINECTOMIE	XI - 13
<b>FERRIS-SMITH-KERRISSON</b>	PINCE EMPORTE-PIECE	XI - 15 à 17
<b>FICAT</b>	TREPAN	XIII - 49
<i>FIL POUR SERRE-NŒUD</i>		XII - 13
<i>FIL SCIE</i>		XIII - 7
<b>FINOCHIETTO</b>	ECARTEUR	VII - 71 à 74
	PASSE-FIL - DISSECTEUR	IV - 54
	PORTE-AIGUILLES	VI - 6
<b>FINSEN</b>	ECARTEUR	VII - 77
<b>FOERSTER</b>	PINCE PORTE-EPONGE	VIII - 2, 3
<b>FOMON</b>	CROCHET ORL	XII - 31
<i>FORCEPS</i>		VIII - 19 à 23
<i>FORET A OS</i>		XIV - 1
<i>FORET POUR PERFORATEUR</i>		XI - 8 et XIV - 31
<i>FORET POUR VIS PERFOREE</i>		XIV - 42
<i>FRAISE A CHAMBRER POUR VIS</i>		XIV - 4
<i>FRAISE POUR PERFORATEUR</i>		XI - 7, 8
<b>FRAZIER</b>	CANULE ORL	XII - 40
	CROCHET ORL	XII - 32
	MICRO CROCHET	X - 19
<b>FREER</b>	BURIN ORL	XII - 24
	CROCHET ORL	XII - 31
	ELEVATEUR ORL	XII - 32
	GOUGE ORL	XII - 26
<b>FRITSCH</b>	ECARTEUR	VII - 44
<b>G</b>		
<i>GABARIT DE FORAGE POUR PLAQUES</i>		XIV - 11

## Index alphabétique

<i>GABARIT DE CINTRAGE POUR PLAQUES</i>		XIV - 14
<b>GALLAHER</b>	RAPE ORL	XII - 28
<i>GARROT CAOUTCHOUC</i>		XV - 2
<b>GELPI</b>	ECARTEUR	VII - 89
<b>GERALD</b>	PINCE A DISSECTION	II - 23
<b>GIGLI</b>	FIL SCIE ET POIGNEE	XIII - 7
<b>GILLIES</b>	CISEAUX PINCE	VI - 18
	CROCHET	VII - 18
<b>GILLIES (WAUGH)</b>	PINCE A DISSECTION	II - 25
<b>GILLIES-BABY</b>	CISEAUX PINCE	VI - 18
<b>GIL-VERNET</b>	ECARTEUR POUR VOIES BILIAIRES	IX - 7
<b>GLOVER</b>	CLAMP BULLDOG	V - 2
	PINCE CLAMP ATRAUMA	V - 19
	PINCE CLAMP ATRAUMA - LIGATURES	V - 20
<b>GOLDMANN-FOX</b>	CISEAUX FINS	III - 30
<i>GOMME DE POLISSAGE</i>		XV - 30
<b>GOSSET</b>	ECARTEUR, VALVE ET SUPPORT	VII - 64, 65
<i>GOUGE</i>		XIII - 23, 35 à 42
<i>GOUGE ORL</i>		XII - 25, 26
<b>GOUILLOUD</b>	PINCE CLAMP	IV - 38
<b>GOURDET</b>	CURETTE UTERINE	VIII - 54
<b>GRAEFE</b>	MICRO CROCHET	X - 17
<b>GRAHAM</b>	MICRO CROCHET	X - 19
<i>GRATTOIR DERMATO</i>		XIII - 25
<b>GREGOIRE</b>	PINCE A DISSECTION	II - 12
	PINCE EN LOSANGE	IV - 71
<b>GREGORY</b>	PINCE CLAMP ATRAUMA - PROFONDEUR	V - 22
<b>GREGORY-SOFT</b>	CLAMP BULLDOG	V - 2
<i>GRIFFES POUR BECKMANN</i>		VII - 86
<b>GROSS-MAYER</b>	PINCE A PANSEMENTS	IV - 3
<i>GUIDE ET EXTRACTEUR POUR CLOUS</i>		XIV - 37
<i>GUIDE-FIL TUBULAIRE POUR CERCLAGE</i>		XIII - 100 et XIV - 48
<i>GUIDE-CLOU</i>		XIV - 38
<i>GUIDE-MECHE</i>		XIV - 8 à 10, 17
<i>GUIDE POUR TARAUD</i>		XIV - 9
<b>GUILLAUME</b>	GOUGE	XIII - 35
<b>GUNNAR-HEY</b>	PINCE A TRAIER LES DRAINS	IV - 82
<b>GUTHRIE</b>	MICRO CROCHET	X - 18
<b>GUYON</b>	BOUGIE DILATATRICE POUR L'URETRE	IX - 9
	PINCE CLAMP RENALE	IV - 36
<b>GUYON-FREUDENBERG</b>	MANDRIN	XV - 28
<b>H</b>		
<b>HALSEY</b>	PORTE-AIGUILLES	VI - 8
<b>HALSTEAD</b>	PINCE HEMOSTATIQUE	IV - 12, 86 et XV - 14
<b>HALSTEAD-MOSQUITO</b>	PINCE HEMOSTATIQUE	IV - 14
<b>HANK</b>	DILATATEUR UTERIN	VIII - 63
<b>HARKEN</b>	PINCE CLAMP ATRAUMA - OREILLETTE	V - 9
<b>HARRINGTON</b>	ECARTEUR	VII - 40
	PASSE-FIL - DISSECTEUR	IV - 53
<b>HARRINGTON-PEMBERTON</b>	ECARTEUR	VII - 40
<b>HARTMANN</b>	ECARTEUR	VII - 4
	PINCE A CORPS ETRANGERS	X - 13, 16
	PINCE A POLYPES	X - 14
	PINCE COPROSTASE	IV - 56
	PINCE EMPORTE-PIECE	XII - 21
	PINCE RONGEUR	X - 14
<b>HARTMANN-CITELLI</b>	PINCE A POLYPES	X - 14
<b>HARTMANN-WEINGARTNER</b>	PINCE A CORPS ETRANGERS	X - 13
<b>HARVEY</b>	CISEAUX COUPE-FILS	III - 20
<b>HAUTANT</b>	BURIN ORL	XII - 25
	GOUGE ORL	XII - 25
<b>HAUTEFEUILLE</b>	PIQUETS	VII - 51
<b>HEANEY</b>	ECARTEUR	VII - 5
<b>HEATH</b>	PINCE A RETIRER LES AGRAFES	VI - 1
<b>HEGAR</b>	DILATATEUR UTERIN	VIII - 61 à 63
<b>HEGAR-OLSEN</b>	PORTE-AIGUILLES	VI - 17
<b>HEGAR-OLSEN-BABY</b>	PORTE-AIGUILLES	VI - 17
<b>HEGEMANN</b>	CISEAUX VASCULAIRES	III - 23
<b>HEGEMANN (DIETRICH)</b>	CISEAUX VASCULAIRES	III - 23
<b>HEIFETZ</b>	SPATULE NEURO	XI - 5
<b>HEISS</b>	PINCE HEMOSTATIQUE LONGUE	IV - 23
<b>HEISS (HOLZHEIMER)</b>	ECARTEUR	VII - 77
<b>HENLEY</b>	ECARTEUR	VII - 80
<b>HENNING</b>	PINCE ECARTANTE - PLATRES	XV - 18
<b>HERCULES</b>	MORS CAOUTCHOUC	XIV - 28
	MORS TUNGSTENE	XIV - 28 à 30
	PINCE COUPE-CABLES	XIV - 30

## Index alphabétique

<b>HERCULES</b>	PINCE COUPE-FILS ET BROCHES	XIV - 28 à 30
	PINCE D'EXTRACTION	XIV - 20
<b>HIBBS</b>	ECARTEUR	VII - 5
<b>HI-LEVEL (KNOWLES)</b>	CISEAUX	III - 18
<b>HOFFMAN</b>	PRESSE-TUBE	IV - 84
<b>HOLSHER</b>	RETRACTEUR A RACINE	XI - 6
<b>HOSEL</b>	ECARTEUR	VII - 31
<b>HRYNTSCHAK</b>	ECARTEUR ET VALVE	VII - 68
<b>HUDSON</b>	PERFORATEUR, FRAISE ET RALLONGE	XI - 8
<b>HUDSON-CUSHING</b>	FORET	XI - 8
<b>HUNTER</b>	PINCE A ECHARDES	II - 28
<b>HURD</b>	ELEVATEUR ORL	XII - 33
<b>HYSTEROGRAPHIE</b>	PINCE	VIII - 59
	SERINGUE, CANULE ET JOINTS	VIII - 58
<i>HYSTEROMETRE</i>		VIII - 64
<b>I</b>		
<b>IMA</b>	MICRO PINCE DISSECTION	X - 12
<i>IMPACTEUR EXTRACTEUR POUR CLOUS</i>		XIV - 38
<i>IMPACTEUR POUR AGRAFES</i>		XIV - 46, 47
<i>IMPACTEUR POUR CLOUS</i>		XIV - 39, 40
<i>IMPACTEUR POUR PLAQUES</i>		XIV - 11
<b>INGE-MEHARY</b>	ECARTEUR	VII - 95
<b>IP SPRAY</b>	LUBRIFIANT	XV - 30
<b>ISRAEL</b>	ECARTEUR	VII - 27
<b>J</b>		
<b>JACOB</b>	POIGNEE EN T AVEC MANDRIN ET CLE	XIV - 3
<b>JACOBSON</b>	MICRO PORTE-AIGUILLES	X - 3
<b>JACOBSON-ADSON</b>	PASSE-FIL - DISSECTEUR	IV - 48
<b>JAMESON</b>	CISEAUX LONGS ET FINS	III - 31, 53
<b>JANSEN</b>	ECARTEUR	VII - 77
	EMPORTE PIECES O.R.L.	XII - 21
<i>JAUGE DE LONGUEUR POUR VIS PERFOREE</i>		XIV - 45
<i>JAUGE DE PROFONDEUR POUR CLOUS</i>		XIV - 41
<i>JAUGE DE PROFONDEUR POUR VIS</i>		XIV - 4
<i>JAUGE POUR ALESOIR ET VIS</i>		XIV - 41
<b>JAVID</b>	PINCE CLAMP ATRAUMA - CAROTIDE	V - 24
<b>JAYLE</b>	SPECULUM VAGINAL	VIII - 35
	VALVE VAGINALE ET POIDS	VIII - 41
<b>JEANNINGS</b>	OUVRE-BOUCHE	XII - 3
<b>JESCO</b>	CISEAUX UNIVERSELS	III - 40
<i>JOINT POUR SERINGUE</i>		VIII - 58
<b>JOLL</b>	ECARTEUR POUR GOITRE	VII - 89
<b>JONES</b>	PINCE A CHAMPS	IV - 78
<b>JOSEPH</b>	CISEAU ORL	III - 56 et XII - 35
	CROCHET ORL	XII - 34
	ELEVATEUR ORL	XII - 35
	RAPE ORL	XII - 34
	RUGINE ORL	XII - 35
	SCIE ORL	XII - 34
<b>JUDD-ALLIS</b>	PINCE A PREHENSION	IV - 74
<b>JUDET</b>	MARTEAU	XIII - 46
<b>K</b>		
<b>KANTROWITZ</b>	PASSE-FIL - DISSECTEUR	IV - 49
<b>KELLY</b>	CISEAUX POUR FISTULE	III - 33
	ECARTEUR	VII - 32
	PINCE HEMOSTATIQUE	IV - 20, 89
<b>KELLY-RANKIN</b>	PINCE HEMOSTATIQUE	IV - 21
<b>KERRISSON</b>	PINCE EMPORTE-PIECE	XII - 19
<b>KIELAND</b>	FORCEPS	VIII - 21
<b>KIENNY</b>	CHAUSSE VEINE	VII - 19
<b>KILLIAN</b>	ELEVATEUR ORL	XII - 32
	GOUGE ORL	XII - 26
	SPECULUM NASAL	XII - 12
<b>KILNER</b>	PORTE-AIGUILLES	VI - 8
<b>KILNER (RAGNELL)</b>	CISEAUX DELICATS	III - 6
<b>KIRSCHNER</b>	CADRE ET VALVES	VII - 60, 61
	ETRIER, CROCHET ET CLE	XIII - 101
	TENDEUR ET CLE	XIII - 101
<b>KLIKENBERG</b>	CISEAUX	III - 34, 49
<b>KNAPP</b>	CISEAUX FINS	III - 26
<b>KOCHER</b>	ECARTEUR	VII - 25, 26, 29
	PINCE CLAMP GASTRO INTESTINALE	IV - 60
	PINCE HEMOSTATIQUE	IV - 6 à 8, 87 et XV - 13
	SPATULE ORL	XII - 17
<b>KOCHER-LANGENBECK</b>	ECARTEUR	VII - 30
<b>KOCHER-WAGNER</b>	ECARTEUR	VII - 31
<b>KOENING</b>	CROCHET	XIII - 50

## Index alphabétique

KOGAN	ENDOSPECULUM	VIII - 36
KRISTELLER	VALVE VAGINALE	VIII - 47
<b>L</b>		
LA GRANGE	CISEAUX FINS	III - 26
LABORDE	DILATATEUR TRACHEO	XII - 5
LAGROT	DERMATOME A MAIN ET LAMES	I - 7
LAHEY	ECARTEUR	VII - 26
	PINCE A PREHENSION ORL	XII - 7
LAMBERT KAY	PINCE CLAMP ATRAUMA - AORTE	V - 13
LAMBOTTE	CROCHET	XIII - 50
	DAVIER	XIII - 81, 82
	LEVIER	VII - 108
	OSTEOTOME	XIII - 31
	PINCE PORTE-VIS	XIV - 19
	RUGINE	XIII - 13
	<i>LAME COUPE-FILS STERILE</i>	I - 2, 5
	<i>LAME DE BISTOURI STERILE</i>	I - 2, 3
	<i>LAME DE RASOIR</i>	X - 20
	<i>LAME MALLEABLE</i>	VII - 7, 8
	<i>LAME MALLEABLE SUR MANCHE</i>	VII - 9, 10
	<i>LAME POUR AMYGDALOTOME</i>	XII - 18
	<i>LAME POUR DERMATOME</i>	I - 6, 7
	<i>LAME POUR SCIE</i>	XIII - 4 à 6
LANDANGER	DAVIER	XIII - 89 à 91
	PINCE A BIOPSIE UTERINE	VIII - 39
	PINCE A MENISQUE	XIII - 109
	PINCE A PANSEMENTS	IV - 2
	PINCE A RETIRER LES AGRAFES	VI - 1
	PORTIQUE SUPPORT INSTRUMENTS	XV - 29
LANDAX 101	PRODUIT RENOVATION	XV - 30
LANE	DAVIER	XIII - 83
	PINCE A DISSECTION	II - 7
LANGE-HOHMANN	ECARTEUR	VII - 100, 102
LANGENBECK	ECARTEUR	VII - 33
	<i>LAPAROSTAT</i>	VII - 70
LARDENOIS	LAME MALLEABLE	VII - 7, 8
LAZAR	MICRO PINCE DISSECTION	X - 11
LE MEE	SPECULUM AURICULAIRE	XII - 11
LE PETIT	PINCE A DISSECTION	II - 16
LEBSCHÉ	STERNOTOME	XIII - 75
LEES	PINCE CLAMP ATRAUMA - BRONCHES	V - 10
LEGUEU	PINCE CLAMP	IV - 37
	PINCE POUR VOIES BILIAIRES	IX - 4
LEKSELL-STILLE	PINCE GOUGE	XIII - 62
LELAND-JONES	PINCE CLAMP ATRAUMA - VAISSEAUX PERIPHERIQUES	V - 6
LEMAIRE	RIFLOIR (RAPE)	XIII - 115
LEMPERT	ELEVATEUR ORL	XII - 33
	PINCE GOUGE	XIII - 55
LEPAGE	PINCE A FAUX GERMES	VIII - 16
LERICHE	CROCHET	VII - 17
	DISSECTEUR (SPATULE)	XIII - 17
	PINCE HEMOSTATIQUE	IV - 16, 87 et XV - 14
	VALVE	VII - 41
LERICHE-BUGATTI	VALVE	VII - 41
LERMOYER	COUTEAU A VEGETATIONS	XII - 15
LETOURNEL	BURIN	XIII - 23
	CURETTE OSSEUSE	XIII - 23
	GOUGE	XIII - 23
	<i>LEVIER A OS</i>	VII - 99, 108
LEWIS	RAPE ORL	XII - 29
LEXER	CISEAUX A DISSECTION	III - 12
	OSTEOTOME	XIII - 34
LIEGE	PINCE A PREHENSION	IV - 75
LIMA	CURETTE ORL	XII - 37
LIPSETT	RAPE ORL	XII - 28
LISTER (CROIX ROUGE)	CISEAUX A PANSEMENT	III - 19, 47 et XV - 10
LISTON	CISAILLE	XIII - 67
	COUTEAU A AMPUTATION	XIII - 4
	PINCE COUPANTE	XIII - 66, 67, 70, 71
LITTAUER	CISEAUX COUPE-LIGATURES	III - 28
LOCHARD	PINCE OUVRE CAPSULE	IV - 83
LOCKLIN	CISEAUX FINS	III - 30
LOMBARD	PINCE GOUGE	XIII - 55
LORNA	PINCE A CHAMPS	IV - 81
LORTAT-JACOB	CADRE SUPPORT INSTRUMENTS	XV - 29
LOUTE	TENDEUR SERRE-FILS	XIII - 93
LOVE-GRUENWALD	PINCE RONGEUR A LAMINECTOMIE	XI - 12

## Index alphabétique

<b>LOVELACE</b>	PINCE A PREHENSION	IV - 70
<b>LOWE</b>	ECARTEUR A RACINE	VII - 14
<b>LOWMAN-HOGLUND</b>	DAVIER	XIII - 93
<b>LUBET-BARBON</b>	PINCE A PREHENSION ORL	XII - 9
<i>LUBRIFIANT</i>		XV - 30
<b>LUC</b>	PINCE A PREHENSION ORL	XII - 8
<b>LUCAE</b>	MICRO CROCHET	X - 20
	PINCE POUR OREILLE	II - 32
<b>LUCAS-CHAMPIONNIERE</b>	BURIN	XIII - 26
	PERFORATEUR A MAIN	XIV - 31
<b>LUER</b>	ECARTEUR	VII - 33
	PINCE GOUGE	XIII - 64
<b>LUER-FRIEDMANN</b>	PINCE GOUGE	XIII - 61
<b>M</b>		
<b>MAC EVEN</b>	MAILLET	XIII - 44, 45
	OSTEOTOME	XIII - 29
<b>MAC INDOE</b>	PINCE COUPANTE	XIII - 68
<b>MAC KEE</b>	ECARTEUR	VII - 81
<b>MAC PHERSON</b>	MICRO PINCE DISSECTION	X - 10
<i>MAGASIN A AGRAFES</i>		VI - 4
<b>MAGILL</b>	PINCE A SONDES	XV - 5
<i>MAILLET ET MASSE</i>		XIII - 43 à 46
<i>MAILLET ORL</i>		XII - 37
<i>MAIN DE PLOMB</i>		XIII - 94
<i>MAIN MALLEABLE SILICONNEE</i>		XIII - 94
<i>MANCHE DE BISTOURI</i>		I - 2 à 4
<i>MANCHE ENCLIQUETAGE RAPIDE</i>		XIV - 3
<i>MANCHE POUR CANULE A IVG</i>		VIII - 51
<i>MANDRIN DE CENTRAGE POUR CLOUS</i>		XIV - 39
<i>MANDRIN POUR TOURNIQUET</i>		V - 29
<b>MANGIAGALLI</b>	VALVE VAGINALE	VIII - 46
<b>MARKHAM-MEYERDING</b>	ECARTEUR	VII - 92
<i>MARTEAU</i>		XIII - 46
<i>MARTEAU A REFLEXES</i>		XV - 1
<i>MARTEAU DIAPASON</i>		XIV - 11, 35
<b>MARTIN</b>	ECARTEUR	VII - 34
<b>MASING</b>	ELEVATEUR ORL	XII - 32
	PORTE-AIGUILLES	VI - 8
<b>MATHIEU</b>	PINCE A POLYPES	VIII - 7
<b>MAURER</b>	COSTOTOME	XIII - 73
	RUGINE	XIII - 14
<b>MAYO</b>	CISEAUX A DISSECTION	III - 7, 42, 50 et XV - 11
	CISEAUX VAGINAL	VIII - 67
	EPINGLE POUR INSTRUMENTS	XV - 29
	PINCE A DISSECTION	II - 12
<b>MAYO-ALSACE</b>	CISEAUX A DISSECTION	III - 9
<b>MAYO-GUYON</b>	PINCE CLAMP RENALE	IV - 36
<b>MAYO-HARRINGTON</b>	CISEAUX A DISSECTION	III - 10
<b>MAYO-HEGAR</b>	PORTE-AIGUILLES	VI - 7, 10, 11 et XV - 13
<b>MAYO-LEGER</b>	CISEAUX A DISSECTION	III - 9
<b>MAYO-LEXER</b>	CISEAUX A DISSECTION	III - 43, 50
<b>MAYO-LYON</b>	CISEAUX A DISSECTION	III - 9
<b>MAYO-NOBLE</b>	CISEAUX A DISSECTION	III - 10
<b>MAYO-ROBSON</b>	PINCE CLAMP GASTRO INTESTINALE	IV - 58
<b>MAYO-SANTY</b>	CISEAUX A DISSECTION	III - 10
<b>MAYO-STILLE</b>	CISEAUX A DISSECTION	III - 8, 50
<b>MC INDOE</b>	PINCE A DISSECTION	II - 18
<b>MEAD</b>	PINCE GOUGE	XIII - 65
<b>MEEKER</b>	PASSE-FIL - DISSECTEUR	IV - 51
<i>MENISCOTOME</i>		XIII - 106
<b>MERIAM</b>	PINCE A DISSECTION	II - 22
<b>MERLE D'AUBIGNE</b>	ECARTEUR	VII - 104, 105
	ECARTEUR EPAULE (BANKART)	XIII - 97, 98
	PASSE-FIL (BANKART)	XIII - 97
	POINTE QUADRANGULAIRE	XIII - 48
	POINTE TRIANGULAIRE	XIII - 48
	RUGINE	XIII - 12
<b>MERVEILLEUX</b>	CISEAUX VASCULAIRES	III - 55
<b>METZENBAUM</b>	CISEAUX A DISSECTION	III - 13, 14, 44, 51 et XV - 12
<b>METZENBAUM-FINO</b>	CISEAUX A DISSECTION	III - 15, 45, 46, 51
<b>MEYERDING</b>	ECARTEUR	VII - 13
<b>MICHEL</b>	AGRAFES A SUTURES	VI - 4
	PINCE A POSER LES AGRAFES	VI - 3
	PINCE A RETIRER LES AGRAFES	VI - 2
	PINCE DOUBLE USAGE	VI - 2
<b>MICHON</b>	PINCE CLAMP	IV - 37
<i>MICRO CISEAUX</i>		X - 6 à 9



## Index alphabétique

<i>MICRO CROCHET</i>		X - 17 à 20
<i>MICRO PINCE A SUTURES</i>		II - 27
<i>MICRO PINCE DISSECTION</i>		X - 10 à 12
<i>MICRO PORTE-AIGUILLES</i>		X - 1 à 5
<b>MICRO-ADSON</b>	PINCE A DISSECTION	II - 17
<b>MICRO-HALSTEAD</b>	PINCE HEMOSTATIQUE	IV - 12
<b>MICRO-MOSQUITO</b>	PINCE HEMOSTATIQUE	IV - 13
<b>MICRO-RYDER</b>	PORTE-AIGUILLES	VI - 14
<b>MIDDELDORPF</b>	ECARTEUR	VII - 45, 46
<b>MIKULICZ</b>	ECARTEUR	VII - 36
	PINCE PERITONEALE	IV - 32
<b>MILLER</b>	RAPE ORL	XII - 30
<b>MILLIN</b>	PINCE POUR VOIES BILIAIRES	IX - 4
<b>MINI-FRIEDMANN</b>	PINCE GOUGE	XIII - 61
<b>MINI-LANGENBECK</b>	ECARTEUR	VII - 11
<b>MINI-TOWSEND</b>	PINCE A BIOPSIE UTERINE	VIII - 37
<b>MIRIZZI</b>	PINCE POUR VOIES BILIAIRES	IX - 1, 2
<i>MIROIR LARYNGIEN ET MANCHE</i>		XV - 4
<b>MOHR</b>	PRESSE-TUBE	IV - 84
<b>MONOD</b>	TROCART	XV - 26
<b>MOORE</b>	CISAILLE ORL	XII - 22
	COUTEAU A VEGETATIONS	XII - 16
<b>MOORE LAMBOTTE</b>	EXTRACTEUR EN T	VII - 108
<b>MOREL-FATIO</b>	RUGINE	XIII - 15
<b>MORRIS</b>	ECARTEUR	VII - 35
<b>MORRIS-DE BAKEY</b>	PINCE CLAMP ATRAUMA - AORTE	V - 15
<i>MORS CAOUTCHOUC - HERCULES</i>		XIV - 28
<i>MORS POUR PINCE COUPE-BROCHES</i>		XIV - 27
<i>MORS TUNGSTENE - HERCULES</i>		XIV - 28 à 30
<b>MOSQUITO</b>	PINCE HEMOSTATIQUE	IV - 11
<b>MOSQUITO-DANDY</b>	PINCE HEMOSTATIQUE	IV - 17
<b>MOYNIHAN</b>	PINCE HEMOSTATIQUE LONGUE	IV - 28
<b>MULLER</b>	CROCHET A PHLEBECTOMIE	V - 29
<b>MURPHY</b>	CISEAU POUR GENOU	XIII - 114
	PINCE PRESSE-TUBE	IV - 85 et XV - 15
<b>MUSEUX</b>	PINCE A GRANDE CREMAILLERE	XIII - 80
	PINCE UTERINE	VIII - 4, 5
<b>MUSEUX PALMER</b>	PINCE UTERINE	VIII - 6
<b>MUSEUX PALMER-CHERON</b>	PINCE UTERINE	VIII - 6
<b>N</b>		
<b>NAGELE</b>	FORCEPS	VIII - 22
<b>NAKATA PAUCHET</b>	AIGUILLE A LIGATURE	VI - 22
<b>NANCY</b>	CISEAUX	III - 18
	GOUGE	XIII - 35
<b>NEGUS</b>	PINCES A PREHENSION	IV - 57
<b>NELATON</b>	BISTOURI	I - 1
	PERFORATEUR A MAIN ET FORETS	XIV - 31
	SONDE	XV - 8
<b>NICOLLET-KOCHER</b>	PINCE A MENISQUE	XIII - 109
<b>NICOLLET-MUSEUX</b>	PINCE A MENISQUE	XIII - 108
<b>NOTTER</b>	PERCE MEMBRANE - AMNIOTOME	VIII - 49
<b>NOVACK</b>	SONDE CURETTE	VIII - 58
<b>NUBOER</b>	CANULE D'ASPIRATION	XV - 23
<b>O</b>		
<b>OCHSNER</b>	PINCE CLAMP ATRAUMA - AORTE	V - 8
<b>ODWYER</b>	OUVRE-BOUCHE	XII - 1
<b>OLIVECRONA</b>	FIL SCIE	XIII - 7
	SPATULE NEURO	XI - 4
<b>OLIVIER</b>	ECARTEUR, CHAINE ET CAPUCHON	VII - 59
<b>OLLIER</b>	DAVIER	XIII - 78, 79
	ECARTEUR	VII - 28
	POINCON	XIII - 111
	RUGINE	XIII - 10
<b>OMBREDANNE</b>	BURIN	XIII - 28
	MAILLET (MASSE)	XIII - 43
	PINCE A PREHENSION	IV - 33
	POINTE CARREE	XIII - 47
<b>ORDINAIRE</b>	CLAMP BULLDOG	V - 3
<b>O'SHAUGNESSY</b>	PASSE-FIL - DISSECTEUR	IV - 41 à 45
<i>OSTEOTOME</i>		XIII - 29 à 34
<i>OUVRE-BOUCHE</i>		XII - 1 à 4
<b>OVERHOLT-GEISSENDORFER</b>	PASSE-FIL - DISSECTEUR	IV - 46
<b>OVERHOLT-SLIM</b>	PASSE-FIL - DISSECTEUR	IV - 47
<b>P</b>		
<b>PAJOT</b>	FORCEPS	VIII - 21
<b>PALMER</b>	ECARTEUR	VII - 58
	PINCE A POLYPES	VIII - 8

# Index alphabétique

<b>PALMER</b>	SPECULUM VAGINAL	VIII - 34
<b>PALMER (BOWMAN)</b>	SPECULUM NASAL	XII - 11
<b>PARKER-LANGENBECK (US ARMY)</b>	E CARTEUR	VII - 48
<i>PASSE-FIL - DISSECTEUR</i>		IV - 40 à 55
<i>PASSE-FIL - SEPARATEUR</i>		IV - 53 à 59
<i>PASSE-FIL (BANKART)</i>		XIII - 97
<i>PASSE-FIL POUR TENDONS</i>		XIII - 1
<i>PASSE-FIL POUR VISEUR DE GENOU</i>		XIII - 111
<i>PASSE-FIL TUBULAIRE POUR CERCLAGE</i>		XIII - 100 et XIV - 48
<b>PAUCHET</b>	PINCE A POSER LES AGRAFES	VI - 3
	PINCES TENAILLE	IV - 34
	SABRE (AIGUILLE)	VI - 22
<b>PAUWELLS</b>	OSTEOTOME	XIII - 30
<b>PAYR</b>	PINCE CLAMP GASTRO INTESTINALE	IV - 61
<b>PEAN</b>	PINCE A PANSEMENTS	IV - 1 et XV - 12
<b>PEERS</b>	PINCE A CHAMPS	IV - 80
<b>PEET</b>	PINCE A ECHARDES	IV - 33
<b>PENNINGTON</b>	PINCE A PREHENSION	IV - 69
	RUGINE ORL	XII - 27
<i>PERCE MEMBRANE - AMNIOTOME</i>		VIII - 49
<b>PERCY</b>	RETRACTEUR POUR AMPUTATION	XIII - 8
<i>PERFORATEUR A MAIN</i>		XI - 7, 8 et XIV - 31
<i>PERFORATEUR A MAIN (BANKART)</i>		XIII - 98
<i>PERFORATEUR INITIAL</i>		XI - 7 et XIV - 35
<b>PERRY</b>	PINCE A DISSECTION	II - 24
<i>PIED A COULISSE</i>		XIII - 51
<i>PINCE A AFFRONTER</i>		VI - 3
<i>PINCE A BIOPSIE UTERINE</i>		VIII - 37 à 40
<i>PINCE A CHAMPS</i>		IV - 78 à 81 et XV - 15
<i>PINCE A CORPS ETRANGERS</i>		X - 13, 15, 16
<i>PINCE A COUPER LES CLAMPS</i>		VIII - 50
<i>PINCE A DECAPSULER</i>		XIII - 92
<i>PINCE A DISSECTION</i>		II - 1 à 40 et XV - 12
<i>PINCE A DISSECTION FINE</i>		II - 4, 5, 24 et XV - 12
<i>PINCE A DISSECTION MICRO</i>		II - 27
<i>PINCE A DISSECTION OPHTHALMO</i>		II - 29
<i>PINCE A DISSECTION PLASTIQUE</i>		XV - 16
<i>PINCE A DISSECTION PRESTIGE</i>		II - 37
<i>PINCE A ECHARDES</i>		II - 24, 27, 28 et IV - 33
<i>PINCE A EPILER</i>		II - 25
<i>PINCE A FAUX GERMES</i>		VIII - 16, 17
<i>PINCE A FILS METALLIQUES</i>		VI - 19 et XIV - 23, 24
<i>PINCE A GRANDE CREMAILLERE (MUSEUX)</i>		XIII - 80
<i>PINCE A LAMBEAUX</i>		VIII - 14
<i>PINCE A LIGAMENT</i>		VIII - 12
<i>PINCE A MENISQUE</i>		XIII - 109, 110
<i>PINCE A ONGLES</i>		XV - 6, 15
<i>PINCE A OVAIRES</i>		VIII - 17
<i>PINCE A PANSEMENTS</i>		IV - 1 à 3 et VIII - 1, 3 et XV - 15
<i>PINCE A PARAMETRE</i>		VIII - 13
<i>PINCE A PLATEAUX</i>		VIII - 12
<i>PINCE A POLYPES</i>		IV - 75 et VIII - 7, 8 et X - 14
<i>PINCE A POSER LES AGRAFES</i>		VI - 3
<i>PINCE A POSER LES CLAMPS</i>		V - 1
<i>PINCE A PREHENSION</i>		IV - 33, 55, 61 à 74
<i>PINCE A PREHENSION ORL</i>		XII - 7 à 10
<i>PINCE A PREHENSION UTERINE</i>		VIII - 15
<i>PINCE A RETIRER LES AGRAFES</i>		VI - 1, 2
<i>PINCE A SEQUESTRE</i>		XIII - 87
<i>PINCE A SONDAS</i>		XV - 5
<i>PINCE A TENDONS</i>		XIII - 2, 3
<i>PINCE A TRAIRES LES DRAINS</i>		IV - 82
<i>PINCE CAPSULAIRE</i>		X - 11
<i>PINCE CLAMP</i>		IV - 35 à 38, 70
<i>PINCE CLAMP A BRONCHES</i>		IV - 62
<i>PINCE CLAMP ATRAUMA</i>		V - 4 à 26
<i>PINCE CLAMP ATRAUMA - ANASTOMOSE</i>		V - 4, 20, 25, 26
<i>PINCE CLAMP ATRAUMA - ANEVRISSME AORTE</i>		V - 7, 8
<i>PINCE CLAMP ATRAUMA - ANEVRISSME ARTERE</i>		V - 16
<i>PINCE CLAMP ATRAUMA - AORTE</i>		V - 8, 9, 11, 12, 13, 15, 22
<i>PINCE CLAMP ATRAUMA - ARTERE RENALE</i>		V - 7
<i>PINCE CLAMP ATRAUMA - BRONCHES</i>		V - 10
<i>PINCE CLAMP ATRAUMA - CAROTIDE</i>		V - 24
<i>PINCE CLAMP ATRAUMA - COARCTATION</i>		V - 4, 16, 17, 24, 25
<i>PINCE CLAMP ATRAUMA - LIGATURES</i>		V - 5, 11, 12, 20, 25
<i>PINCE CLAMP ATRAUMA - OCCLUSION TANGENTIELLE</i>		V - 13
<i>PINCE CLAMP ATRAUMA - OREILLETTE</i>		V - 9

## Index alphabétique

PINCE CLAMP ATRAUMA - PEDIATRIE	V - 26 à 28
PINCE CLAMP ATRAUMA - PERIPHERIQUE	V - 21
PINCE CLAMP ATRAUMA - PROFONDEUR	V - 22
PINCE CLAMP ATRAUMA - USAGES MULTIPLES	V - 15, 24
PINCE CLAMP ATRAUMA - VAISSEAUX PERIPHERIQUES	V - 6
PINCE CLAMP GASTRO INTESTINALE	IV - 56 à 61
PINCE CLAMP HEMORROIDALE	IV - 77
PINCE CLAMP RENALE	IV - 36
PINCE COPROSTASE	IV - 56, 57
PINCE COUPANTE	XIII - 66 à 75
PINCE COUPANTE UNIVERSELLE	XIV - 25
PINCE COUPE-BROCHES	XIV - 27
PINCE COUPE-CABLES	XIV - 30
PINCE COUPE-FILS ET BROCHES	XIV - 25 à 30
PINCE D'EXTRACTION	XIV - 20
PINCE D'EXTRACTION POUR CLOUS	XIV - 40
PINCE DOUBLE USAGE POUR AGRAFES	VI - 2
PINCE ECARTANTE POUR PLATRES	XV - 18
PINCE EMPORTE-PIECE	XI - 15 à 17 et XII -19, 21
PINCE EN COEUR	IV - 64
PINCE EN LOSANGE	IV - 66, 71
PINCE EN TRIANGLE	IV - 66, 71
PINCE ETAU	XIV - 21
PINCE GOUGE	XIII - 52 à 65
PINCE HEMOSTATIQUE	IV - 4 à 22, 31, 86 à 90 et XV - 13, 14
PINCE HEMOSTATIQUE LONGUE	IV - 23 à 28, 39, 90
PINCE HEMOSTATIQUE PRESTIGE	IV - 86 à 90
PINCE HEMOSTATIQUE SPECIALE	IV - 29 à 32
PINCE HYSTEROLABLE	VIII - 18
PINCE MORS PARALLELES	XIV - 21
PINCE MULTISERVICE	XIV - 22
PINCE OUVRE CAPSULE	IV - 83
PINCE OVALAIRE	IV - 66, 71
PINCE PERITONEALE	IV - 32
PINCE PORTE-EPONGE	VIII - 2, 3
PINCE PORTE-VIS	XIV - 19
PINCE POUR ARTERE UTERINE	VIII - 11, 16
PINCE POUR CINTRER LES CLOUS	XIV - 41
PINCE POUR CINTRER LES PLAQUES	XIV - 15, 16
PINCE POUR EPAULE (BANKART)	XIII - 97
PINCE POUR HYSTEROGRAPHIE	VIII - 59
PINCE POUR LES PLATRES	XV - 17
PINCE POUR MINI PLAQUES	XIV - 19
PINCE POUR OESOPHAGOSCOPIE	XII - 23
PINCE POUR OREILLE	II - 30 à 32
PINCE POUR SAISIR LES VIS	XIV - 4
PINCE POUR STERILET	VIII - 51
PINCE POUR VOIES BILIAIRES	IX - 1 à 5
PINCE PRECELLE	II - 24
PINCE PRESSE-TUBE	IV - 83, 85 et XV - 15
PINCE RONGEUR	X - 14 et XII - 20
PINCE RONGEUR A LAMINECTOMIE	XI - 12 à 14
PINCE TENAILLE	IV - 34
PINCE TIRE-BROCHES	XIV - 19
PINCE UNIVERSELLE	XIV - 21
PINCE UTERINE	VIII - 4 à 17
PIQUET POUR TABLE D'OPERATION	VII - 51
PLAQUE POUR TENDRE LA PEAU	I - 6
PLAQUE REPERE ANGLE POUR PLAQUES	XIV - 11
PLATEAU RECTANGULAIRE	XV - 21
POIDS POUR VALVES VAGINALES	VIII - 41
POIGNEE (MINI) A MANDRIN	XIV - 3
POIGNEE EN T AVEC MANDRIN	XIV - 3
POIGNEE ENCLIQUETAGE RAPIDE	XIV - 3
POIGNEE POUR FIL SCIE	XIII - 7
POINCON	XIII - 49, 112
POINTE CARREE	XIII - 47
POINTE QUADRANGULAIRE	XIII - 48
POINTE TRIANGULAIRE	XIII - 48
POIRE	XV - 29
<b>POIRIER</b>	BURIN XIII - 26
	GOUGE XIII - 36
<b>POLITZER</b>	II - 31
<b>POLOSSON</b>	VII - 38, 39
PORTE-AGRAFES	XIV - 46
PORTE-AIGUILLES	VI - 5 à 16 et XV - 13, 14
PORTE-COTON	XV - 9

## Index alphabétique

<i>PORTE-LAME</i>		X - 20
<i>PORTE-PLAQUE IMPACTEUR EXTRACTEUR</i>		XIV - 11, 13
<i>PORTIQUE SUPPORT INSTRUMENTS</i>		XV - 29
<b>POST AVORTUM</b>	PINCE A FAUX GERMES	
<b>POSTEL</b>	ECARTEUR	VII - 108
	SCIE A MAIN ET LAME	XIII - 4
<b>POTTS-SMITH</b>	CISEAUX VASCULAIRES	III - 21, 54
	PINCE A DISSECTION	II - 20, 36
<b>POTTS DE MARTEL</b>	CISEAUX VASCULAIRES	III - 24
<i>POUSSE-CLOU</i>		XIV - 38
<b>POZZI</b>	PINCE EPAULE (BANKART)	XIII - 98
	PINCE UTERINE	VIII - 9
<b>POZZI-PALMER</b>	PINCE UTERINE	VIII - 9
<b>PRATT</b>	PINCE CLAMP HEMORROIDALE	IV - 77
<i>PRESSE POUR CINTRER LES PLAQUES</i>		XIV - 16
<i>PRESSE-TUBE</i>		IV - 84
<b>PRICE-THOMAS</b>	PINCE CLAMP A BRONCHES	IV - 62
<b>PRIMA</b>	BISTOURI STERILE	I - 5
<i>PRODUIT RENOVATION</i>		XV - 30
<i>PROTECTION SILICONE</i>		XII - 4
<b>PROVIDENCE</b>	PINCE HEMOSTATIQUE	IV - 17
<b>Q</b>		
<b>QUENU</b>	PINCE A DISSECTION	II - 15
	PINCE CLAMP GASTRO INTESTINALE	IV - 56
<b>QUILICY-FARISSE</b>	PASSE-FIL - DISSECTEUR	IV - 50
<b>QUIRE</b>	PINCE A CORPS ETRANGERS	X - 15
<b>R</b>		
<i>RACCORD LUER-LOCK</i>		XV - 24
<b>RAGNEL</b>	ECARTEUR	VII - 19
<i>RALLONGE POUR PERFORATEUR</i>		XI - 8
<i>RAPE A OS</i>		XIII - 18
<i>RAPE ORL</i>		XII - 28 à 30, 34
<i>RAPPROCHEUR DE COTES</i>		VII - 76
<b>RECAMIER</b>	CURETTE UTERINE	VIII - 56
<b>REDON</b>	AIGUILLE	VI - 23
	PASSE-FIL - DISSECTEUR	IV - 40
<i>REFOULOIR</i>		XIII - 100
<i>REGLET - MESUREUR</i>		XIII - 51
<b>RESANO</b>	PINCE CLAMP GASTRO INTESTINALE	IV - 55
<i>RETRACTEUR A RACINE</i>		XI - 6
<i>RETRACTEUR ORL</i>		XII - 36
<i>RETRACTEUR POUR AMPUTATION</i>		XIII - 8
<i>RETRACTEUR PROSTATIQUE</i>		VII - 43
<b>REVERDIN</b>	AIGUILLE A SUTURES	VI - 20
<b>REYNOLDS</b>	CISEAUX FINS	III - 31, 53
<b>RICARD</b>	ECARTEUR COMPLET	VII - 53
	VALVE	VII - 52
<b>RICARD-BEGOIN</b>	COMPAS	VII - 52
	ECARTEUR COMPLET	VII - 55
	VALVE	VII - 54
<b>RICHARDSON</b>	ECARTEUR	VII - 32
<b>RICHARDSON-EASTMAN</b>	ECARTEUR	VII - 6
<i>RIFLOIR (RAPE)</i>		XIII - 115
<b>RIZZUTI</b>	SPATULE DISSECTEUR	XI - 10
<b>ROBB</b>	SPATULE DISSECTEUR	XI - 11
<b>ROBERTS</b>	PINCE HEMOSTATIQUE LONGUE	IV - 26
<b>ROBIN</b>	BURIN ORL	XII - 24
<b>ROCHARD</b>	COMPAS	VII - 47
	PINCE POUR ARTERE UTERINE	VIII - 16
	VALVE	VII - 48
<b>ROCHER</b>	POINCON	XIII - 49
<b>ROCHESTER-CARMALT</b>	PINCE HEMOSTATIQUE	IV - 31
<b>ROCHESTER-OSCHNER</b>	PINCE HEMOSTATIQUE	IV - 10
<b>ROCHESTER-PEAN</b>	PINCE HEMOSTATIQUE	IV - 9
<b>ROGERS</b>	PINCE A PARAMETRE	VIII - 13
<b>ROUENNAIS</b>	CISEAUX	III - 39
<b>ROUX</b>	ECARTEUR	VII - 4
<b>RUALT</b>	FAUX POUR AMYGDALECTOMIE	XII - 17
<i>RUGINE</i>		XIII - 9 à 16, 112
<i>RUGINE A LIGAMENTS JAUNES</i>		XIII - 15
<i>RUGINE A PERIOSTOMIE</i>		XIII - 11
<i>RUGINE A SCIATIQUE</i>		XI - 1
<i>RUGINE A TENDONS</i>		XIII - 1
<i>RUGINE COSTALE</i>		XIII - 10
<i>RUGINE ORL</i>		XII - 27, 35
<b>RUMEL</b>	PASSE-FIL - DISSECTEUR	IV - 51
<b>RUMMEL-BELMONT</b>	TOURNIQUET VASCULAIRE ET MANDRIN	V - 29

## Index alphabétique

<b>RUSKIN-LISTON</b>	PINCE COUPANTE	XIII - 69
<b>RYDER</b>	PORTE-AIGUILLES	VI - 14
<b>S</b>		
<i>SABRE (AIGUILLE)</i>		VI - 22
<b>SANTULLI</b>	CLAMP BULLDOG	V - 2
<b>SANTY</b>	CANULE D'ASPIRATION	XV - 23
	PINCE HEMOSTATIQUE LONGUE	IV - 27
<b>SAROT</b>	PINCE HEMOSTATIQUE LONGUE	IV - 26
	PORTE-AIGUILLES	VI - 15
<b>SATINSKY</b>	CISEAUX EN S	III - 34
	PINCE CLAMP ATRAUMA - OCCLUSION TANGENTIELLE	V - 13
<b>SAUERBRUCH</b>	COSTOTOME	XIII - 74
	PINCE GOUGE	XIII - 58
<b>SAUERBRUCH-FREY</b>	COSTOTOME	XIII - 74
<b>SCHADEL</b>	PINCE A CHAMPS	IV - 78
<b>SCHIEBE</b>	PINCE CLMAP INTESTINALE ET STOMACALE	IV - 58
<b>SCHINK</b>	DERMATOME A MAIN, LAME ET PLAQUE	I - 6
<b>SCHNIDT</b>	PASSE-FIL - DISSECTEUR	IV - 48
<b>SCHROEDER</b>	PINCE UTERINE	VIII - 10
<b>SCHUMAKER</b>	PINCE A BIOPSIE UTERINE	VIII - 39
<i>SCIE A AMPUTATION</i>		XIII - 5, 6
<i>SCIE A MAIN</i>		XIII - 4
<i>SCIE COUPE-BAGUE ET LAME</i>		XV - 7
<i>SCIE ORL</i>		XII - 34
<b>SEBILEAU</b>	CURETTE ORL	XII - 39
	RUGINE ORL	XII - 27
<b>SEGURA</b>	MAILLET ORL	XII - 37
<b>SEMB</b>	DAVIER	XIII - 80
	PASSE-FIL - DISSECTEUR	IV - 52
	RUGINE	XIII - 12
<b>SEMB-SAYLOR</b>	PASSE-FIL - DISSECTEUR	IV - 52
<b>SEMKEN</b>	PINCE A DISSECTION	II - 26
<b>SENN-MILLER</b>	ECARTEUR	VII - 19
<i>SERINGUE</i>		VIII - 58 et XV - 27
<i>SERRE-NOEUD ORL</i>		XII - 13
<b>SHUBERT</b>	PINCE A BIOPSIE UTERINE	VIII - 40
<b>SICARD</b>	PINCE GOUGE	XIII - 59
<b>SICART</b>	SPATULE DECOLLE DURE MERE	XI - 1
<b>SIEBOLD</b>	CISEAUX EN S	III - 34
<b>SIMON</b>	CURETTE UTERINE	VIII - 52
	ECARTEUR	VII - 34
<b>SIMS</b>	BISTOURI	I - 1
	CISEAUX UTERINS	III - 36, 49, 56
	CURETTE UTERINE	VIII - 53
	HYSTEROMETRE	VIII - 64
	SPECULUM RECTAL	VIII - 26
<b>SINGLEY-TUTTLE</b>	PINCE A DISSECTION	II - 16
<b>SISTERON</b>	PINCE POUR VOIES BILIAIRES	IX - 3
<b>SLUDDER-BALLENGER</b>	AMYGDALOTOME ET LAMES	XII - 18
<b>SMILLIE-TRILLAT</b>	ECARTEUR POUR GENOU	XIII - 106, 107
	MENISCOTOME	XIII - 105
	WISEUR, CANON ET PASSE-FIL POUR GENOU	XIII - 110
<b>SMITH-PETERSEN</b>	GOUGE	XIII - 38
	PINCE GOUGE	XIII - 62
<b>SNELLEN</b>	CURETTE ORL	XII - 38
<i>SONDE</i>		XV - 8
<i>SONDE CANNELEE</i>		XV - 8
<i>SONDE CURETTE</i>		VIII - 57
<i>SONDE METALLIQUE</i>		IX - 8
<i>SPATULE</i>		XIII - 99
<i>SPATULE DISSECTEUR</i>		XI - 10, 11
<i>SPATULE NEURO</i>		XI - 3 à 5
<i>SPATULE ORL</i>		XII - 17
<i>SPATULE POUR DURE MERE</i>		XI - 1, 2, 9
<i>SPATULE POUR SCIATIQUE</i>		XI - 2
<i>SPATULES (FORCEPS)</i>		VIII - 22, 23
<i>SPECULUM AURICULAIRE</i>		XII - 11
<i>SPECULUM NASAL</i>		XII - 11, 12
<i>SPECULUM RECTAL</i>		VIII - 26
<i>SPECULUM VAGINAL</i>		VIII - 30 à 35
<i>SPECULUM VAGINAL POUR VIERGE</i>		VIII - 34
<b>SPENCER</b>	CISEAUX COUPE-LIGATURES	III - 27
<b>SPENCER-FINO</b>	CISEAUX COUPE-LIGATURES	III - 28
<b>SPENCER-WELLS</b>	PINCE HEMOSTATIQUE	IV - 4, 5
<b>SPURLING</b>	PINCE RONGEUR A LAMINECTOMIE	XI - 12
<b>STAGNARA</b>	GOUGE	XIII - 41
<b>STAMEY</b>	AIGUILLE	VI - 22

## Index alphabétique

<b>STEIMANN</b>	PINCE A TENDONS	XIII - 2
<i>STERNOTOME</i>		XIII - 75
<b>STEVENS</b>	CISEAUX FINS	III - 29, 53
<b>STILLE</b>	BURIN	XIII - 28
	GOUGE	XIII - 37
	OSTEOTOME	XIII - 34
	PINCE CLAMP	IV - 35
	PINCE GOUGE	XIII - 56
<b>STRASBOURG</b>	PINCE A DISSECTION (A TALON)	II - 8
<b>STRATT</b>	PORTE-AIGUILLES	VI - 12
<b>STRAUSS</b>	COMPRESSEUR POUR L'URETRE	IX - 8
<b>STRELI</b>	PORTE-AIGUILLES	VI - 5
<b>STRULLY</b>	CISEAUX LONGS ET FINS	III - 33
<i>STYLET OLIVAIRE</i>		XV - 8
<i>STYLET PORTE-COTON</i>		XV - 8
<b>SUBRAMANIAN</b>	PINCE CLAMP ATRAUMA - AORTE	V - 22
<i>SUPPORT DE GENOU</i>		XIII - 113
<i>SUPPORT POUR VALVE</i>		VII - 65
<i>SYSTEME DE SERRAGE POUR FORCEPS</i>		VIII - 20
<b>T</b>		
<b>TAKAHASHI</b>	RAPE ORL	XII - 28
	PINCE RONGEUR	XII - 20
<i>TARAUD</i>		XIV - 2
<i>TARAUD POUR VIS PERFOREE</i>		XIV - 42
<b>TARNIER</b>	FORCEPS ET TRACTEUR	VIII - 19
<b>TAYLOR</b>	PINCE A DISSECTION	II - 21
	RETRACTEUR A RACINE	XI - 6
<b>TEISSIER</b>	SPATULES ET TRACTEUR	VIII - 23
<i>TENDEUR POUR ETRIER</i>		XIII - 101
<i>TENDEUR POUR PLAQUES</i>		XIV - 17
<i>TENDEUR SERRE-FILS POUR CERCLAGE</i>		XIII - 93 et XIV - 48
<i>TENOTOME</i>		I - 1
<b>TERRIER</b>	OUVRE-BOUCHE	XII - 1
	PINCE HEMOSTATIQUE	IV - 4
<b>THERUM</b>	PINCE POUR STERILET	VIII - 51
<b>THIERRY</b>	SPATULES (FORCEPS)	VIII - 22
<i>TIGE DE NETTOYAGE POUR VIS PERFOREE</i>		XIV - 45
<i>TIGE GUIDE POUR ALESOIRS ET CLOUS</i>		XIV - 34
<i>TIRE-COMEDONS</i>		XIII - 25
<b>TISCHLER-MORGAN</b>	PINCE A BIOPSIE	VIII - 37
<b>TOENNIS</b>	CISEAUX LONGS ET FINS	III - 32, 46
<b>TOENNIS-ADSON</b>	CISEAUX LONGS ET FINS	III - 32
<b>TOHOKU</b>	PINCE A CHAMPS	IV - 81
<i>TORD-BROCHES</i>		XIV - 19
<b>TOUPET</b>	DEPRESSEUR DOUBLE	VII - 56
	PINCE CLAMP	IV - 38
	PIQUET, CHAINE ET CURSEUR	VII - 51
	VALVES	VII - 52
<i>TOURNEVIS</i>		XIV - 5 à 7
<i>TOURNEVIS - MANCHE ET TIGE</i>		XIV - 6, 7
<i>TOURNEVIS - PREHENSEUR</i>		XIV - 6
<i>TOURNEVIS POUR VIS PERFOREE</i>		XIV - 44
<i>TOURNIQUET VASCULAIRE</i>		V - 29
<i>TRACTEUR POUR FIBROME</i>		VIII - 49
<i>TRACTEUR POUR FORCEPS</i>		VIII - 19, 23
<b>TRELAT</b>	DILATATEUR ANAL	VIII - 25
<i>TREPAN</i>		XIII - 49
<i>TRICOISE</i>		XIII - 75
<b>TRILLAT</b>	CROCHET A MENISQUE	XIII - 112
	CROCHET EXPLORATEUR	XIII - 112
	ECARTEUR POUR AVANT-BRAS	VII - 106
	ECARTEUR POUR EPAULE	XIII - 111
	RUGINE	XIII - 112
	TROCART	XIII - 112
<i>TROCART</i>		XIII - 112 et XV - 25
<i>TROCART AVEC GUIDE POUR CLOUS</i>		XIV - 39
<i>TROCART POUR BIOPSIE OSSEUSE</i>		XV - 25
<b>TROELTSCH</b>	PINCE POUR OREILLE	II - 30
<b>TROUSSEAU</b>	DILATATEUR TRACHEO	XII - 5
<b>TUBIANA</b>	PORTE-AIGUILLES	VI - 5
<b>TUFFIER</b>	ECARTEUR	VII - 76
	PINCE A PREHENSION	IV - 75
<b>U</b>		
<b>ULTRA-ASEPT</b>	SERINGUES ET CYLINDRES VERRE	XV - 27
<b>UNIVERSEL</b>	CISEAUX COUPE-FILS	III - 20, 47
<b>UNIVERSELLE</b>	PINCE	XIV - 21
	PINCE COUPANTE	XIV - 25

## Index alphabétique

<b>UNNA</b>	TIRE-COMEDONS	XIII - 25
<i>URINAL</i>		XV - 20
<b>V</b>		
<b>VACHER</b>	SERRE-NŒUD ORL, CANULE ET FIL	XII - 13
	SPECULUM NASAL	XII - 11
<b>VALLEIX</b>	HYSTEROMETRE ET CURSEUR	VIII - 64
<i>VALVE</i>		VII - 36 à 39
<i>VALVE A POUMON</i>		VII - 8
<i>VALVE POUR ECARTEUR</i>		VII - 48 à 68, 87, 98 et VIII - 28 et XIII - 94
<i>VALVE SURMOULEE SILICONE</i>		VII - 8
<i>VALVE VAGINALE</i>		VIII - 41 à 48
<b>VANNAS</b>	MICRO CISEAUX	X - 6, 7
<b>VELPEAU</b>	TRICOISE	XIII - 75
<i>VENTOUSE OBSTETRICALE ET ACCESSOIRES</i>		VIII - 60
<b>VERBRUGGE</b>	DAVIER	XIII - 76, 84 à 86
<b>VERBRUGGE-MULLER</b>	ECARTEUR	VII - 103
<b>VERNON</b>	MARTEAU A RELEXES	XV - 1
<b>VERWYNIL</b>	CADRE, VALVES ET BOUTON	VII - 63
<b>VEZIEN</b>	CISEAUX	VIII - 65
<b>VIDAL</b>	GRATTOIR DERMATO	XIII - 25
<b>VINCENT</b>	PINCE A DISSECTION	II - 6, 38
	PINCE GOUGE	XIII - 59
<b>VINCENT (SCHMIEDEN TAYLOR)</b>	CISEAUX DIVERS	III - 25
<i>VIS ANNEAU POUR CADRE</i>		VII - 64
<i>VISEUR A POINTE</i>		XIV - 8
<i>VISEUR POUR BROCHES GUIDE</i>		XIV - 43
<i>VISEUR POUR GENOU</i>		XIII - 110
<i>VISEUR POUR PLAQUES</i>		XIV - 12
<b>VOLKMANN</b>	CURETTE OSSEUSE	XIII - 19, 20
	CURETTE UTERINE	VIII - 57
	ECARTEUR	VII - 21 à 24
<b>W</b>		
<b>WAGENER</b>	MICRO CROCHET	X - 18
<b>WAGNER</b>	CISEAUX DELICATS	III - 5, 52
<b>WALDMANN</b>	CISEAUX A EPISIOTOMIE	VIII - 67
<b>WALLICH</b>	CURETTE UTERINE	VIII - 55
<b>WALTER-CARMALT</b>	PINCE A DISSECTION	II - 28
<b>WALTER-DUVAL</b>	PINCE A PREHENSION	IV - 65
<b>WALTON</b>	ECARTEUR POUR HEMILAMINECTOMIE	VII - 93
<b>WEBER</b>	PINCE CLAMP ATRAUMA - AORTE	V - 12
<b>WEIL-BLAKESLEY</b>	PINCE RONGEUR A LAMINECTOMIE	XI - 14
<b>WEISS</b>	PINCE PRESSE-TUBE	IV - 83
<b>WEITLANER</b>	ECARTEUR	VII - 78, 79
<b>WEITLANER NEURO</b>	ECARTEUR	VII - 91
<b>WEITLANER-WULLSTEIN</b>	ECARTEUR	VII - 90
<b>WERTHEIM (BOZEMANN)</b>	PORTE-AIGUILLES	VI - 12
<b>WERTHEIMER</b>	CANULE ORL	XII - 40
<b>WHITE</b>	PINCE A PREHENSION ORL	XII - 10
<b>WILLIAMS</b>	TOURNEVIS	XIV - 6
<b>WILLIGER</b>	RUGINE	XIII - 15
<b>WOLF</b>	PINCE POUR PLATRES	XV - 18
<b>Y</b>		
<b>YANKAUER</b>	CANULE D'ASPIRATION	XV - 23
<b>YASARGIL</b>	MICRO CISEAUX	X - 9
	MICRO PORTE-AIGUILLES	X - 5

# Alphabetical index

## A

<b>ABADIE</b>	RETRACTOR	VII - 69
<b>ABOULKER</b>	E.N.T. DILATOR	XII - 6
	NEUROSURGERY DISSECTOR	XI - 10
	RETRACTOR	VII - 15
<i>ADENOIDS CURETTES</i>		XII - 15, 16
<b>ADLERKREUTZ</b>	DISSECTING FORCEPS	II - 11, 39
<b>ADSON</b>	DISSECTING FORCEPS	II - 17, 35 et XV - 12
	RETRACTOR FOR LAMINECTOM	VII - 94
<b>ADSON BROWN</b>	DISSECTING FORCEPS	II - 18
<b>ALAN PARKS</b>	RECTAL RETRACTOR AND BLADE	VIII - 28
<b>ALLAINE</b>	DISSECTING SCISSORS	III - 16, 17
	LIGATURE FORCEPS - DISSECTORS	IV - 45
<b>ALLAIRE</b>	DELICATE SCISSORS	III - 6
<b>ALLIS</b>	GRASPING FORCEPS	IV - 73
<b>ALM</b>	RETRACTOR	VII - 77
<i>ALUMINIUM TREATED BOX</i>		XV - 22
<b>AMERICAIN</b>	OSSEOUS INSTRUMENTATION WIRE TRACTION BOW	XIII - 103
<i>AMPUTATION KNIFE</i>		XIII - 4
<i>AMYGDALOTOME</i>		XII - 18
<i>ANAL DILATOR</i>		VIII - 25
<b>ANDREW PYNCHON</b>	SUCTION CANNULA	XV - 23
<i>ANGLED FORCEPS</i>		II - 24
<i>ANUSCOPE</i>		VIII - 24
<b>ARRUGA</b>	CAPSULE FORCEPS	X - 11
<i>ATRAUMA CARDIOVASCULAR FORCEPS</i>		V - 4 à 26
<i>ATRAUMA CARDIOVASCULAR FORCEPS FOR ANASTOMOSIS</i>		V - 4, 20, 25, 26
<i>ATRAUMA CARDIOVASCULAR FORCEPS FOR AORTIC</i>		V - 8, 9, 11, 12, 13, 15, 22
<i>ATRAUMA CARDIOVASCULAR FORCEPS FOR AORTIC ANEURYSM</i>		V - 7, 8
<i>ATRAUMA CARDIOVASCULAR FORCEPS FOR ARTERY ANEURYSM</i>		V - 16
<i>ATRAUMA CARDIOVASCULAR FORCEPS FOR AURICLE</i>		V - 9
<i>ATRAUMA CARDIOVASCULAR FORCEPS FOR BRONCHUS</i>		V - 10
<i>ATRAUMA CARDIOVASCULAR FORCEPS FOR CAROTID</i>		V - 24
<i>ATRAUMA CARDIOVASCULAR FORCEPS FOR COACTATION</i>		V - 4, 16, 17, 24, 25
<i>ATRAUMA CARDIOVASCULAR FORCEPS FOR LIGATURE</i>		V - 5, 11, 12, 20, 25
<i>ATRAUMA CARDIOVASCULAR FORCEPS FOR PERIPHERAL VASCULAR</i>		V - 6
<i>ATRAUMA CARDIOVASCULAR FORCEPS FOR RENAL ARTERY</i>		V - 7
<i>ATRAUMA CARDIOVASCULAR FORCEPS FOR TANGENTIAL OCCLUSION</i>		V - 13
<i>ATRAUMA FORCEPS - MULTI-PURPOSE</i>		V - 15, 24
<i>ATRAUMA FORCEPS - PERIPHERAL</i>		V - 21
<i>ATRAUMA FORCEPS - PROFUNDA</i>		V - 22
<b>AUBRY</b>	Z SHAPE RETRACTOR	XII - 36
<b>AUFRIEHT</b>	E.N.T. RAPS	XII - 30
<i>AURICULAR SPECULUM</i>		XII - 11
<i>AUTO-CENTERING BONE HOLDING FORCEPS</i>		XIII - 87
<b>AUVERT</b>	CLAMP FORCEPS	IV - 70
	FRAME, BLADES, VICE AND SCREW	VII - 64
<i>AXE TRACTION FOR OBSTETRICAL FORCEPS</i>		VIII - 19, 23
<b>B</b>		
<b>BABCOCK</b>	GRASPING FORCEPS	IV - 76
<b>BABINSKY</b>	PERCUSSION HAMMER	XV - 1
<b>BABY-ADSON</b>	LIGATURE FORCEPS - DISSECTORS	IV - 40
<b>BABY-ALLIS</b>	GRASPING FORCEPS	IV - 74
<b>BABY-CRILE-WOOD</b>	NEEDLE HOLDER	VI - 9
<b>BABY-DOYEN</b>	INTESTINAL CLAMP FORCEPS	IV - 58
<b>BABY-LEXER</b>	DISSECTING SCISSORS	III - 12
<b>BABY-METZENBAUM</b>	DISSECTING SCISSORS	III - 51
<b>BABY-MIKULICZ</b>	SPECIAL HAEMOSTATIC FORCEPS	IV - 32
<b>BABY-SENN-MILLER</b>	RETRACTOR	VII - 20
<b>BACKHAUS</b>	TOWEL FORCEPS	IV - 79,80 et XV - 15
<b>BAILLEY</b>	RIB CONTRACTOR	VII - 76
<b>BAINBRIDGE</b>	ATRAUMA CARDIOVASCULAR FORCEPS	V - 6
	SPECIAL HAEMOSTATIC FORCEPS	IV - 29
<b>BAKES</b>	DILATOR FOR BILE DUCTS	IX - 10
<b>BALFOUR</b>	RETRACTOR AND BLADES	VII - 67
<b>BALFOUR-BABY</b>	RETRACTOR	VII - 67
<b>BALLENGER</b>	GOUGE FOR NASAL PARTITION	XII - 26
<i>BANDAGE SCISSORS</i>		III - 19, 47 et XV - 11
<b>BAR</b>	RECTAL RETRACTOR	VIII - 27
	UMBILICAL CLAMP AND FORCEPS TO CUT THE CLAMPS	VIII - 50
<b>BARRAQUER</b>	MICROSURGERY NEEDLE HOLDER	X - 4
<b>BARRAYA</b>	DISSECTING FORCEPS	II - 9, 10, 39
	LIGATURE FORCEPS - SEPARATOR	IV - 53
<b>BECK</b>	ATRAUMA CARDIOVASCULAR FORCEPS	V - 14
<b>BECKMANN</b>	ADENOIDS CURETTES	XII - 15
	RETRACTOR	VII - 82 à 85
	RETRACTOR AND EXCHANGEABLE BLADES	VII - 86, 87



## Alphabetical index

<b>BECKMANN CONE</b>	RETRACTOR	VII - 82 à 84
<b>BEEBEE</b>	WIRE CUTTING SCISSORS	III - 20
<i>BENDING PRESS FOR PLATES</i>		XIV - 16
<i>BENDING TEMPLATE FOR NAILS</i>		XIV - 41
<b>BENGOLEA</b>	LONG HAEMOSTATIC FORCEPS	IV - 24, 25, 88
<b>BENNET</b>	RETRACTOR	VII - 106
<b>BENSAUDE</b>	ANUSCOPE	VIII - 24
<b>BENSON</b>	MISCELLANEOUS FORCEPS	IV - 77
<b>BERGER</b>	UTERINE BIOPSY FORCEPS	VIII - 38
<b>BERGMANN</b>	HOOK	VII - 17
<b>BESNIER</b>	DERMATOLOGY CURETTE	XIII - 24
<b>BEYER</b>	BONE RONGEUR FORCEPS	XIII - 60
<b>BEYER-ZAUFAL</b>	BONE RONGEUR FORCEPS	XIII - 63
<b>BILLEAU</b>	E.N.T. CURETTE	XII - 38
<b>BIRCHER</b>	MENISCUS FORCEPS	XIII - 109
<i>BLADE</i>		VII - 36 à 39
<i>BLADE FOR AMYGDALOTOME</i>		XII - 18
<i>BLADE FOR LUNG</i>		VII - 8
<i>BLADE FOR RETRACTOR</i>		VII - 48 à 68, 87, 98 et VIII - 28 et XIII - 94
<i>BLADE FOR SAW</i>		XIII - 4 à 6
<i>BLADE HOLDER</i>		X - 20
<b>BLUMENTHAL</b>	BONE RONGEUR FORCEPS	XIII - 65
<i>BLUNT SCISSORS</i>		III - 1, 41 et XV - 11
<b>BOEHLER</b>	WIRE TRACTION BOW AND HOOK	XIII - 104
<b>BOETCHER</b>	MISCELLANEOUS SCISSORS	III - 25
<b>BOHLER</b>	BONE RONGEUR FORCEPS	XIII - 60
	CUTTING FORCEPS	XIII - 68
<i>BONE CHISEL</i>		XIII - 19 à 23 et 26 à 34
<i>BONE CHISEL - BLADE - HANDLE AND WRENCH</i>		XIV - 18
<i>BONE HOLDING FORCEPS</i>		XIII - 76 à 91
<i>BONE HOLDING FORCEPS WITH LION TEETH</i>		XIII - 78
<i>BONE HOLDING FORCEPS WITH POINTS</i>		XIII - 88
<i>BONE LEVER</i>		VII - 99, 108
<i>BONE RASP</i>		XIII - 18
<i>BONE RONGEUR FORCEPS</i>		XIII - 52 à 65
<i>BONE RONGEURS</i>		X - 14 et XII - 20
<i>BONE WIRE TIGHTENER</i>		XIII - 93 et XIV - 48
<i>BONES DRILL</i>		XIV - 1
<b>BONNAIRE</b>	OVUM FORCEPS	VIII - 17
<b>BONNIOT</b>	HAEMOSTATIC FORCEPS	IV - 15
<b>BORDIER-MEUNIER</b>	TROCAR	XV - 25
<b>BOURGEOIS</b>	E.N.T. GRASPING FORCEPS	XII - 7
<b>BOZEMANN</b>	DRESSING FORCEPS	VIII - 3
	LONG HAEMOSTATIC FORCEPS	IV - 39
<i>BRAIN KNIFE</i>		XIII - 8
<b>BRAND</b>	TENDON'S FORCEPS	XIII - 3
<b>BRAUN-STADLER</b>	EPISTOMY SCISSORS	VIII - 66
<b>BRIESKY</b>	VAGINAL BLADE	VIII - 47
<b>BROCK</b>	SCRAPPER	XIII - 25
<b>BROWN RESANO</b>	DISSECTING FORCEPS	II - 14
<b>BRUNNER</b>	RETRACTOR	VII - 33
<b>BRUNS</b>	BONE CHISEL	XIII - 21, 22
	PLASTER SCISSORS	XV - 17
<b>BUCK</b>	FORCEPS LOOSE FOREIGN BODY	X - 15
<b>BUCK-GRAMCKO</b>	BONE LEVER	VII - 99
<i>BULB</i>		XV - 29
<i>BULLDOG CLAMP</i>		V - 1 à 3
<b>BUSCH</b>	SCISSORS	VIII - 65
<b>C</b>		
<i>CABLE CUT FORCEPS</i>		XIV - 30
<b>CAIRNS (CLOVIS-VINCENT)</b>	SPATULA FOR CIATIC	XI - 2
<i>CALIPER</i>		XIII - 51
<i>CANAL CLEANER FOR CANNULATED SCREW</i>		XIV - 45
<i>CANNULA</i>		VIII - 58
<i>CANNULA FOR SNARE</i>		XII - 13
<i>CANNULAS - TAP - TUBING</i>		XV - 20
<i>CAPS FOR RETRACTOR</i>		VII - 59
<i>CAPSULE FORCEPS</i>		X - 11
<i>CAPSULE OPENING FORCEPS</i>		IV - 83
<b>CARPENTIER</b>	NEUROSURGERY DISSECTOR	XI - 11
<b>CARREL</b>	LYMPHOGRAPHIA CLAMP	V - 3
<b>CASTANEDA</b>	PEDIATRIC CLAMP	V - 28
<b>CASTROVIEJO</b>	BLADE HOLDER	X - 20
	MICROSURGERY NEEDLE HOLDER	X - 1, 2
<i>CATHETER FORCEPS</i>		XV - 5
<b>CAUCHOIX</b>	GOUGE	XIII - 39
	OSTEOTOME	XIII - 33

## Alphabetical index

<b>CAUCHOIX</b>	RETRACTOR	VII - 107
<i>CENTERING SLEEVE FOR NAILS</i>		XIV - 39
<i>CHAIN FOR PEG</i>		VII - 51
<i>CHAIN FOR RETRACTOR</i>		VII - 59
<i>CHAIN WITH CURSOR</i>		VII - 51
<b>CHAPUT</b>	GRASPING FORCEPS	IV - 72
<b>CHAPUT-MAYO</b>	GRASPING FORCEPS	IV - 72
<b>CHARNLEY</b>	BONE CHISEL	XIII - 23
	FRAME AND BLADES	XIII - 94
<b>CHARRIERE</b>	AMPUTATION SAW AND BLADE	XIII - 5
<b>CHATELIER</b>	E.N.T. GRASPING FORCEPS	XII - 7
<b>CHERON</b>	DRESSING FORCEPS	VIII - 1
<b>CHEVALIER-JACKSON</b>	FORCEPS FOR OESOPHAGOSCOPY	XII - 23
<b>CHIGOT</b>	RETRACTOR	VII - 11
<i>CHISEL FOR NASAL PARTITION</i>		XII - 24, 25
<i>CHISEL GUIDE FOR PLATES</i>		XIV - 11
<b>CHRISTOPHE</b>	HAEMOSTATIC FORCEPS	IV - 22, 90
<b>CHROBAK</b>	UTERINES FORCEPS	VIII - 14
<i>CLAMP DISSECTOR</i>		VIII - 10
<i>CLAMP FORCEPS</i>		IV - 35 à 38, 70
<i>CLAMP FORCEPS FOR BRONHUS</i>		IV - 62
<b>CLAOUÉ</b>	E.N.T. RETRACTOR	XII - 36
<i>CLEANING OF INSTRUMENTS</i>		XV - 30
<i>CLIP APPLYING FORCEPS</i>		VI - 3
<i>CLIP APPLYING FORCEPS WITH FIXED MAGAZINE</i>		VI - 3
<i>CLIP APPLYING AND REMOVING FORCEPS</i>		VI - 2
<i>CLIP MAGAZINE</i>		VI - 4
<i>CLIP REMOVING FORCEPS</i>		VI - 1, 2
<b>CLOVIS-VINCENT</b>	E.N.T. CURETTE	XII - 38
	RASPATORY FOR SCIATIC	XI - 1
	REAMER	XI - 7
	SPATULA FOR NEUROSURGERY	XI - 3
<b>CLOWARD</b>	RETRACTOR	VII - 96, 97
	RETRACTOR AND VALVE	VII - 98
<b>COBB</b>	GOUGE	XIII - 42
	RASPATORY	XIII - 16
<i>COIL FORCEPS</i>		VIII - 51
<b>COLLIN</b>	COSTOTOME	XIII - 72
	GRASPING FORCEPS	IV - 69
	VAGINAL SPECULUM	VIII - 30 à 32
<b>COLVER</b>	E.N.T. GRASPING FORCEPS	XII - 10
<i>COMEDONE EXTRACTOR</i>		XIII - 25
<i>COMPASS (RETRACTOR)</i>		VII - 47, 52, 57
<i>CONDUCTOR FOR WIRE SAW</i>		XIII - 7
<i>CONNECTING PLATE FOR OBSTETRICAL FORCEPS</i>		VIII - 20
<b>COOLEY</b>	ATRAUMA CARDIOVASCULAR FORCEPS FOR ANASTOMOSIS	V - 25, 26
	ATRAUMA CARDIOVASCULAR FORCEPS FOR COACTATION	V - 24, 25
	ATRAUMA CARDIOVASCULAR FORCEPS FOR LIGATURE	V - 25
	ATRAUMA FORCEPS - MULTI-PURPOSE	V - 24
	DISSECTING FORCEPS	II - 34
	PEDIATRIC CLAMP	V - 26, 27
<i>COPROSTASIS FORCEPS</i>		IV - 56, 57
<i>COSTAL RASPATORY</i>		XIII - 10
<i>COSTOTOME</i>		XIII - 72 à 75
<b>COTT</b>	COMPASS AND BLADES	VII - 57
	COTTE TATTERS FORCEPS	VIII - 14
<i>COTTE TATTERS FORCEPS</i>		VIII - 14
<b>COTTLE</b>	CHISEL FOR NASAL PARTITION	XII - 24
	E.N.T. RAPS	XII - 29
	NASAL HOOK	XII - 31
<i>COTTON HOLDER</i>		XV - 8, 9
<b>CRABE</b>	TOWEL FORCEPS	IV - 78
<b>CRAFOORD</b>	SCISSORS FOR LOBECTOMY	III - 35
<b>CRAFORD (SELLORS)</b>	SPECIAL HAEMOSTATIC FORCEPS	IV - 30
<b>CREED</b>	SPATULA FOR SCIATIC	XI - 2
<b>CRILE</b>	HAEMOSTATIC FORCEPS	IV - 19, 90
	HOOK	XI - 9
<b>CRILE-WOOD</b>	NEEDLE HOLDER	VI - 9 et XV - 13
<i>CUPPING GLASS OBSTETRIC AND ACCESSORIES</i>		VIII - 60
<i>CURETTE FOR BILE DUCTS</i>		IX - 6
<i>CURETTE PROBE</i>		VIII - 57
<i>CURSOR FOR CHAIN</i>		VII - 51
<i>CURSOR FOR UTERINE SOLIND</i>		VIII - 64
<b>CUSCO</b>	VAGINAL SPECULUM	VIII - 33
<b>CUSHING</b>	DECOMPRESSION RETRACTOR	VII - 20
	DISSECTING FORCEPS	II - 19, 36
	HOOK	XI - 9

# Alphabetical index

<b>CUSHING</b>	LAMINECTOMY RONGEURS	XI - 12
	MICROSURGERY HOOKS	X - 19
	RETRACTOR	VII - 16
	SPATULA FOR NEUROSURGERY	XI - 4
<i>CUTTING FORCEPS</i>		XIII - 66 à 75
<i>CYLINDER FOR KNEE WIEWFINDER</i>		XIII - 110
<b>CZERNY</b>	GRASPING UTERINE FORCEPS	VIII - 15
<b>D</b>		
<b>DALE</b>	ATRAUMA FORCEPS - PERIPHERAL	V - 21
<b>DANDY</b>	HAEMOSTATIC FORCEPS	IV - 17
	MICROSURGERY HOOKS	X - 19
<b>DANIS</b>	SPATULA	XIII - 99
	TAMPING TOOL	XIII - 100
	TIGHTENER	XIII - 93
	TUBULAR WIRE GUIDE	XIII - 100
	VARIOUS RETRACTORS	XIII - 99
<b>DARGENT</b>	CLAMP DISSECTOR	VIII - 10
	VAGINAL BLADE	VIII - 48
<b>DARTIGUES</b>	LAPAROSTAT	VII - 70
	UTERINE ELEVATING FORCEPS	VIII - 18
<i>DAUPHIN SCISSORS</i>		III - 3 et XV - 11
<b>DAUTREY</b>	E.N.T. RETRACTOR	XII - 36
<b>DAVID</b>	BONE RONGEUR FORCEPS	XIII - 58
<b>DAVIS</b>	DURE MERE SPATULA	XI - 9
<b>DAVIS-BOYLE</b>	MOUTH GAG	XII - 4
<b>DE BAKEY</b>	ATRAUMA CARDIOVASCULAR FORCEPS	V - 5, 14, 18, 19, 23
	ATRAUMA CARDIOVASCULAR FORCEPS FOR AORTIC	V - 11, 12
	ATRAUMA CARDIOVASCULAR FORCEPS FOR AORTIC ANEURYSM	V - 7, 8
	ATRAUMA CARDIOVASCULAR FORCEPS FOR LIGATURE	V - 5, 11, 12
	ATRAUMA CARDIOVASCULAR FORCEPS FOR MULTI PORPOSE	V - 15
	ATRAUMA CARDIOVASCULAR FORCEPS FOR RENAL ARTERY	V - 7
	BULLDOG CLAMP	V - 1
	DISSECTING FORCEPS	II - 33, 34
	NEEDLE HOLDER	VI - 13
	SCISSORS FOR VASCULAR SURGERY	III - 22
<b>DE BAKEY-BAHNSON</b>	ATRAUMA CARDIOVASCULAR FORCEPS FOR ARTERY ANEURYSM	V - 16
<b>DE BAKEY-CAROTID</b>	BULLDOG CLAMP	V - 2
<b>DE BAKEY-FINE</b>	NEEDLE HOLDER	VI - 13
<b>DE BAKEY-GLOVER</b>	BULLDOG CLAMP	V - 1
<b>DE BAKEY-MOSQUITO</b>	ATRAUMA CARDIOVASCULAR FORCEPS	V - 18
<b>DE BAKEY-PEAN</b>	ATRAUMA CARDIOVASCULAR FORCEPS	V - 17
<b>DE BAKEY-POTTS</b>	ATRAUMA CARDIOVASCULAR FORCEPS FOR ANASTOMOSIS	V - 4
	ATRAUMA CARDIOVASCULAR FORCEPS FOR COACTATION	V - 4
<b>DE BAKEY-RANKIN</b>	ATRAUMA CARDIOVASCULAR FORCEPS	V - 18
<b>DE BAKEY-SATINSKY</b>	BULLDOG CLAMP	V - 2
<b>DE MARTEL</b>	CONDUCTOR FOR WIRE SAW	XIII - 7
	GRASPING FORCEPS	IV - 63
	SCISSORS FOR VASCULAR SURGERY	III - 24
<b>DEAVER</b>	RETRACTOR	VII - 42, 43
<i>DECOMPRESSION RECRACTOR</i>		VII - 18
<b>DECOULX</b>	RETRACTOR	VII - 88
<b>DELESTRE</b>	EPISIOTOMY SCISSORS	VIII - 66
<i>DELICATE SCISSORS</i>		III - 5, 6, 52
<b>DEMLIN-SUZOR</b>	OBSTETRICAL FORCEPS AND ACCESSORIE	VIII - 20
<b>DEMOISELLE</b>	GRAFT REMOVER	XIII - 95
<b>DENIS-BROWN</b>	FRAME AND BLADES	VII - 62
<i>DEPTH GAUGE FOR SCREW</i>		XIV - 4
<i>DERMATOLOGY CURETTE</i>		XIII - 24
<i>DERMATOME BLADE</i>		I - 6, 7
<b>DERRA</b>	ATRAUMA CARDIOVASCULAR FORCEPS FOR ANASTOMOSIS	V - 20
<b>DESCHAMPS</b>	LIGATURE NEEDLE	VI - 24
<b>DESCHAMPS-SCHAUTA</b>	LIGATURE NEEDLE	VI - 24
<b>DESGOUTTES</b>	DISSECTING FORCEPS	II - 14
<b>DESJARDINS</b>	CURETTE FOR BILE DUCTS	IX - 6
	FORCEPS FOR BILE DUCTS	IX - 3, 5
	PROBE FOR BILE DUCTS	IX - 6
	SCOOP FOR BILE DUCTS	IX - 6
<b>DESMARETS</b>	RETRACTOR	VII - 50
<b>DESMARRES</b>	RETRACTOR	VII - 15, 17
<i>DETACHER FOR TENDONS</i>		XIII - 1
<i>DIAMAND JAW FORCEPS</i>		IV - 66, 71
<b>DIETRICH</b>	ATRAUMA CARDIOVASCULAR FORCEPS FOR AORTIC	V - 9
<b>DIGMANN</b>	BONE HOLDING FORCEPS	XIII - 80
<i>DILATOR</i>		XII - 5
<i>DILATOR FOR BILE DUCTS</i>		IX - 10
<i>DILATOR FOR URETHRA</i>		IX - 9
<i>DIRECTOR</i>		XV - 8

## Alphabetical index

<i>DISSECTING FORCEPS</i>		II - 1 à 40 et XV - 12
<i>DISSECTING SCISSORS</i>		III - 7 à 17, 42 à 51 et XV - 11, 12
<i>DISSECTOR (SPATULA)</i>		XIII - 17
<b>DIXON-LOVELACE</b>	HAEMOSTATIC FORCEPS	IV - 18
<b>DOUAY</b>	UTERINE BIOPSY FORCEPS	VIII - 38
<i>DOUCHE CAN</i>		XV - 20
<b>DOUGLAS</b>	VAGINAL BLADE	VIII - 46
<b>DOYEN</b>	BONE DRILL, TREPAN AND REAMERS	XI - 7
	COPROSTASIS FORCEPS	IV - 57
	COSTAL RASPATORY	XIII - 10
	COSTOTOME	XIII - 75
	INTESTINAL CLAMP FORCEPS	IV - 59
	MIOMA SCREW	VIII - 49
	MISCELLANEOUS SCISSORS	III - 18
	MOUTH GAG	XII - 2
	NEEDLE	VI - 21
	NEEDLE HOLDER	VI - 5
	OVARIAN FORCEPS	VIII - 17
	TOWEL FORCEPS	IV - 78
	VAGINAL BLADE	VIII - 42
<b>DOYEN-ROCHARD</b>	BLADE	VII - 49
<b>DR BARRE</b>	FORCEPS FOR BILE DUCTS	IX - 5
<i>DRESSING FORCEPS</i>		IV - 1 à 3 et VIII - 1, 3 et XV - 15
<i>DRESSMAKER SCISSORS</i>		III - 38
<i>DRILL FOR BONE DRILL</i>		XI - 7, 8 et XIV - 31
<i>DRILL FOR CANNULATED SCREW</i>		XIV - 42
<i>DRILL GUIDE</i>		XIV - 8 à 10, 17
<i>DRILL GUIDE FOR PLATES</i>		XIV - 11
<i>DRIVER AND EXTRACTOR FOR NAILS</i>		XIV - 37
<b>DUBOIS</b>	UTERINE SCISSORS	III - 36
<b>DUBOST</b>	DISSECTING SCISSORS	III - 11, 48
	RETRACTOR	VII - 75
<b>DUFOURMENTEL</b>	E.N.T. RAPS	XII - 28
<b>DUMONT</b>	MICRO DISSECTING FORCEPS	II - 28
<b>DUPLAY</b>	E.N.T. SPECULUM	XII - 11
<b>DUPONT</b>	OSTEOTOME	XIII - 32
<b>DURAND</b>	DISSECTING FORCEPS	II - 12, 40
<i>DURE MERE HOOK</i>		XI - 1
<i>DURE MERE SPATULA</i>		XI - 1, 2, 9
<b>DUVAL</b>	DISSECTING FORCEPS	II - 16
	GRASPING FORCEPS	IV - 67, 68
<b>E</b>		
<i>E.N.T. CANNULA</i>		XII - 40
<i>E.N.T. CURETTE</i>		XII - 38, 39
<i>E.N.T. DILATOR</i>		XII - 6
<i>E.N.T. FROCEP</i>		II - 30 à 32
<i>E.N.T. GRASPING FORCEPS</i>		XII - 7 à 10
<i>E.N.T. HOOK EXO-LEVER</i>		XII - 32, 33, 35
<i>E.N.T. MALLET</i>		XII - 37
<i>E.N.T. RAPS</i>		XII - 28 à 30, 34
<i>E.N.T. RASPATORIES</i>		XII - 27, 35
<i>E.N.T. RETRACTOR</i>		XII - 36
<i>E.N.T. SAW</i>		XII - 34
<i>E.N.T. SCISSORS</i>		III - 56 et XII - 35
<i>E.N.T. SHEAR FORCEPS</i>		XII - 22
<i>E.N.T. SPATULA</i>		XII - 17
<i>E.N.T. SPECULUM</i>		XII - 11, 12
<b>ECHLIN</b>	BONE RONGEUR FORCEPS	XIII - 57
<b>EMMET</b>	NEEDLE	VI - 22
<i>ENDOSPECULAS</i>		VIII - 36
<b>ENEMA</b>	BULB	XV - 28
<i>ENT SNARE</i>		XII - 13
<i>ENUCLEATION SCISSORS</i>		III - 5
<i>EPILATION FORCEPS</i>		II - 25
<i>EPILATION NEEDLE</i>		XV - 26
<i>EPISIOTOMY SCISSORS</i>		VIII - 66, 67
<b>ESMARCH</b>	RUBBER BANDAGE	XV - 2
<b>EUFRATE</b>	NEEDLE HOLDER	VI - 16
<b>EUFRATE-PASQUE</b>	NEEDLE HOLDER	VI - 15
<b>EVANS</b>	DISSECTING FORCEPS	II - 36
<i>EXTENSION PIECE FOR DRILL</i>		XI - 8
<i>EXTRACTION FORCEPS</i>		XIV - 20
<i>EXTRACTION FORCEPS FOR NAILS</i>		XIV - 40
<i>EXTRACTION HOOK</i>		XIV - 36
<i>EXTRACTOR FOR NAILS</i>		XIV - 38
<b>F</b>		
<b>FARABEUF</b>	BONE CHISEL	XIII - 27

## Alphabetical index

<b>FARABEUF</b>	BONE HOLDING FORCEPS	XIII - 77	
	GOUGE	XIII - 40	
	RASPATORY	XIII - 9	
	RETRACTOR	VII - 1	
	SAW AND BLADES	XIII - 6	
	SCALPEL	I - 1	
<b>FARABEUF-CORTI</b>	RETRACTOR	VII - 3	
<b>FARKAS</b>	DISSECTING FORCEPS	II - 15	
<b>FAURE (J.L)</b>	DISSECTING FORCEPS	II - 13	
	FORCEPS FOR LIGAMENT	VIII - 12	
	FORCEPS FOR UTERINE ARTERY	VIII - 11	
	FORCEPS WITH PLATES	VIII - 12	
<b>FEILCHENFELD</b>	SPLINTERS FORCEPS	II - 28	
<b>FERRIS-SMITH-CUSHING</b>	LAMINECTOMY RONGEURS	XI - 13	
<b>FERRIS-SMITH-KERRISSON</b>	PUNCHES FORCEPS	XI - 15 à 17	
<b>FICAT</b>	PUNCH	XIII - 49	
	<i>FINE DISSECTION FORCEPS</i>	II - 4, 5, 24 et XV - 12	
	<i>FINE SCISSORS</i>	III - 26, 29 à 31, 41, 52, 53	
<b>FINOCHIETTO</b>	LIGATURE FORCEPS - DISSECTORS	IV - 54	
	NEEDLE HOLDER	VI - 6	
	RETRACTOR	VII - 71 à 74	
<b>FINSEN</b>	RETRACTOR	VII - 77	
	<i>FLAT WRENCH</i>	XIII - 102 et XIV - 17	
	<i>FLEXIBLE MEDULLARY REAMER</i>	XIV - 32	
	<i>FLUTED DIRECTOR</i>	XV - 8	
<b>FOERSTER</b>	FORCEPS FOR SPONGE	VIII - 2, 3	
<b>FOMON</b>	NASAL HOOK	XII - 31	
	<i>FORCEPS FOR BILE DUCTS</i>	IX - 1 à 5	
	<i>FORCEPS FOR DRAWING DRAINAGE-TUBE</i>	IV - 82	
	<i>FORCEPS FOR LIGAMENT</i>	VIII - 12	
	<i>FORCEPS FOR OESOPHAGOSCOPY</i>	XII - 23	
	<i>FORCEPS FOR SCREW</i>	XIV - 4	
	<i>FORCEPS FOR SPONGE</i>	VIII - 2, 3	
	<i>FORCEPS FOR UTERINE ARTERY</i>	VIII - 11, 16	
	<i>FORCEPS LOOSE FOREIGN BODY</i>	X - 13, 15, 16	
	<i>FORCEPS TO CUT THE CLAMPS</i>	VIII - 50	
	<i>FORCEPS TO TAKE CAPSULES OFF</i>	XIII - 92	
	<i>FORCEPS WITH LONG RACK (MUSEUX)</i>	XIII - 80	
	<i>FORCEPS WITH PLATES</i>	VIII - 12	
	<i>FRAME (RETRACTOR)</i>	VII - 60 à 64 et XIII - 94	
	<b>FRAZIER</b>	E.N.T. CANNULA	XII - 40
		MICROSURGERY HOOKS	X - 19
		NASAL HOOK	XII - 32
		<b>FREER</b>	CHISEL FOR NASAL PARTITION
		E.N.T. HOOK EXO-LEVER	XII - 32
		GOUGE FOR NASAL PARTITION	XII - 26
		NASAL HOOK	XII - 31
<b>FRITSCH</b>	RETRACTOR	VII - 44	
<b>G</b>			
<b>GALLAHER</b>	E.N.T. RAPS	XII - 28	
<b>GELPI</b>	RETRACTOR	VII - 89	
<b>GERALD</b>	DISSECTING FORCEPS	II - 23	
<b>GIGLI</b>	WIRE SAW AND HANDLE	XIII - 7	
<b>GILLIES</b>	HOOK	VII - 18	
	SCISSOR FORCEPS	VI - 18	
<b>GILLIES (WAUGH)</b>	DISSECTING FORCEPS	II - 25	
<b>GILLIES-BABY</b>	SCISSOR FORCEPS	VI - 18	
<b>GIL-VERNET</b>	RETRACTOR FOR BILE DUCTS	IX - 7	
<b>GLOVER</b>	ATRAUMA CARDIOVASCULAR FORCEPS	V - 19	
	ATRAUMA CARDIOVASCULAR FORCEPS FOR LIGATURE	V - 20	
	BULLDOG CLAMP	V - 2	
	<i>GLUER SCISSORS</i>	III - 37	
<b>GOLDMANN-FOX</b>	FINE SCISSORS	III - 30	
<b>GOSSET</b>	RETRACTOR	VII - 64, 65	
	<i>GOUGE</i>	XIII - 23, 35 à 42	
	<i>GOUGE FOR NASAL PARTITION</i>	XII - 25, 26	
<b>GOUILLOUD</b>	CLAMP FORCEPS	IV - 38	
<b>GOURDET</b>	UTERINE CURETTE	VIII - 54	
	<i>GRADUATED CHISEL FOR PLATES</i>	XIV - 11, 13	
<b>GRAEFE</b>	MICROSURGERY HOOKS	X - 17	
	<i>GRAFT REMOVER</i>	XIII - 95, 96	
	<i>GRAFTS SKIN AMPLIFIER</i>	I - 8	
<b>GRAHAM</b>	MICROSURGERY HOOKS	X - 19	
	<i>GRASPING FORCEPS</i>	IV - 33, 55, 61 à 74	
	<i>GRASPING UTERINE FORCEPS</i>	VIII - 15	
<b>GREGOIRE</b>	DIAMAND JAW FORCEPS	IV - 71	
	DISSECTING FORCEPS	II - 12	

## Alphabetical index

<b>GREGORY</b>	ATRAUMA FORCEPS - PROFUNDA	V - 22
<b>GREGORY-SOFT</b>	BULLDOG CLAMP	V - 2
<b>GROSS-MAYER</b>	DRESSING FORCEPS	IV - 3
<i>GUIDE FOR REAMERS AND NAILS</i>		XIV - 34
<i>GUIDE PIN FOR CANNULATED SCREW</i>		XIV - 43
<b>GUILLAUME</b>	GOUGE	XIII - 35
<b>GUNNAR-HEY</b>	FORCEPS FOR DRAWING DRAINAGE-TUBE	IV - 82
<b>GUTHRIE</b>	MICROSURGERY HOOKS	X - 18
<b>GUYON</b>	DILATOR FOR URETHRA	IX - 9
	KIDNEY CLAMPS FORCEPS	IV - 36
<b>GUYON-FREUDENBERG</b>	CHUCK	XV - 28
<b>H</b>		
<i>HAEMOSTATIC FORCEPS</i>		IV - 4 à 22, 31, 86 à 90 et XV - 13, 14
<i>HAIRDRESSER SCISSORS</i>		III - 37
<b>HALSEY</b>	NEEDLE HOLDER	VI - 8
<b>HALSTEAD</b>	HAEMOSTATIC FORCEPS	IV - 12, 86 et XV - 14
<b>HALSTEAD-MOSQUITO</b>	HAEMOSTATIC FORCEPS	IV - 14
<i>HAMMER</i>		XIII - 46
<i>HAND DERMATOME</i>		I - 6, 7
<i>HAND DRILL</i>		XI - 7, 8 et XIV - 31
<i>HAND DRILL (BANKART)</i>		XIII - 98
<i>HAND REAMER</i>		XIV - 35
<i>HAND SAW</i>		XIII - 4
<i>HANDLE FOR CANNULA IVG</i>		VIII - 51
<i>HANDLE FOR WIRE SAW</i>		XIII - 7
<i>HAND'S BONES HOLDING FORCEPS</i>		XIII - 76
<b>HANK</b>	UTERINE DILATOR	VIII - 63
<b>HARKEN</b>	ATRAUMA CARDIOVASCULAR FORCEPS FOR AURICLE	V - 9
<b>HARRINGTON</b>	LIGATURE FORCEPS - DISSECTORS	IV - 53
	RETRACTOR	VII - 40
<b>HARRINGTON-PEMBERTON</b>	RETRACTOR	VII - 40
<b>HARTMANN</b>	BONE RONGEURS	X - 14
	COPROSTASIS FORCEPS	IV - 56
	FORCEPS LOOSE FOREIGN BODY	X - 13, 16
	PUNCH FORCEPS	XII - 21
	RETRACTOR	VII - 4
	UTERINES FORCEPS (POLYPUS)	X - 14
<b>HARTMANN-CITELLI</b>	UTERINES FORCEPS (POLYPUS)	X - 14
<b>HARTMANN-WEINGARTNER</b>	FORCEPS LOOSE FOREIGN BODY	X - 13
<b>HARVEY</b>	WIRE CUTTING SCISSORS	III - 20
<b>HAUTANT</b>	CHISEL FOR NASAL PARTITION	XII - 25
	GOUGE FOR NASAL PARTITION	XII - 25
<b>HAUTEFEUILLE</b>	RETRACTOR	VII - 51
<b>HEANEY</b>	RETRACTOR	VII - 5
<i>HEART-SHAPED FORCEPS</i>		IV - 64
<b>HEATH</b>	CLIP REMOVING FORCEPS	VI - 1
<b>HEGAR</b>	UTERINE DILATOR	VIII - 61 à 63
<b>HEGAR-OLSEN</b>	NEEDLE HOLDER	VI - 17
<b>HEGAR-OLSEN-BABY</b>	NEEDLE HOLDER	VI - 17
<b>HEGEMANN</b>	SCISSORS FOR VASCULAR SURGERY	III - 23
<b>HEGEMANN (DIETRICH)</b>	SCISSORS FOR VASCULAR SURGERY	III - 23
<b>HEIFETZ</b>	SPATULA FOR NEUROSURGERY	XI - 5
<b>HEISS</b>	LONG HAEMOSTATIC FORCEPS	IV - 23
<b>HEISS (HOLZHEIMER)</b>	RETRACTOR	VII - 77
<i>HEMORRHOIDAL CLAMP</i>		IV - 77
<b>HENLEY</b>	RETRACTOR	VII - 80
<b>HENNING</b>	PLASTER CAST SPREADER	XV - 18
<i>HEPARIN CANNULA</i>		XV - 24
<b>HERCULES</b>	CABLE CUT FORCEPS	XIV - 30
	EXTRACTION FORCEPS	XIV - 20
	RUBBER JAWS	XIV - 28
	TUNGSTEN JAW	XIV - 28 à 30
	WIRE CUTTING PLIERS	XIV - 28 à 30
<b>HIBBS</b>	RETRACTOR	VII - 5
<b>HI-LEVEL (KNOWLES)</b>	MISCELLANEOUS SCISSORS	III - 18
<b>HOFFMAN</b>	TUBING FORCEPS	IV - 84
<i>HOLDING FORCEPS FOR MINI PLATES</i>		XIV - 19
<b>HOLSHER</b>	RETRACTOR FOR ROOTS	XI - 6
<i>HOOK</i>		VII - 17, 18 et XI - 9 et XIII - 50, 101 à 103
<i>HOOK FOR SCREW HEAD</i>		XIV - 4
<b>HOSEL</b>	RETRACTOR	VII - 31
<b>HRYNTSCHAK</b>	RETRACTOR AND BLADES	VII - 68
<b>HUDSON</b>	BONE DRILL, REAMER AND EXTENSION	XI - 8
<b>HUDSON-CUSHING</b>	DRILL	XI - 8
<b>HUNTER</b>	SPLINTERS FORCEPS	II - 28
<b>HURD</b>	E.N.T. HOOK EXO-LEVER	XII - 33
<b>HYSTEROGRAPHY</b>	FORCEPS	VIII - 59

# Alphabetical index

<b>HYSTEROGRAPHY</b>	SYRINGE, CANNULA AND SEALS	VIII - 58
<i>HYSTEROGRAPHY FORCEPS</i>		VIII - 59
<b>I</b>		
<b>IMA</b>	MICROSURGERY DISSECTING FORCEPS	X - 12
<i>IMPACTOR EXTRACTOR FOR NAILS</i>		XIV - 38
<i>IMPACTOR FOR NAILS</i>		XIV - 39, 40
<i>IMPACTOR FOR PLATES</i>		XIV - 11
<i>IMPACTOR GUIDE</i>		XIV - 38
<b>INGE-MEHARY</b>	RETRACTOR	VII - 95
<i>INITIAL DRILL</i>		XI - 7 et XIV - 35
<i>INOX TREATED BOX</i>		XV - 22
<i>INSERT DRILL SLEEVE</i>		XIV - 9
<i>INSERTER EXTRACTOR</i>		XIV - 11, 13
<i>INSTRUMENTS HOLDER</i>		XV - 29
<i>INSTRUMENTS HOLDER FRAME</i>		XV - 29
<i>INSTRUMENTS PINS</i>		XV - 28
<i>INTESTINAL CLAMP FORCEPS</i>		IV - 56 à 61
<b>IP SPRAY</b>	LUBRIFICANT	XV - 30
<i>IRIDECTOMIE SCISSORS</i>		III - 4, 52 et XV - 11
<i>IRON FOR PINS</i>		XIV - 19
<b>ISRAEL</b>	RETRACTOR	VII - 27
<b>J</b>		
<b>JACOB</b>	CHUCK AND KEY	XIV - 3
<b>JACOBSON</b>	MICROSURGERY NEEDLE HOLDER	X - 3
<b>JACOBSON-ADSON</b>	LIGATURE FORCEPS - DISSECTORS	IV - 48
<b>JAMESON</b>	LONG FINE SCISSORS	III - 31, 53
<b>JANSEN</b>	E.N.T. PUNCH FORCEPS	XII - 21
	RETRACTOR	VII - 77
<b>JAVID</b>	ATRAUMA CARDIOVASCULAR FORCEPS FOR CAROTID	V - 24
<i>JAWS FOR PIN CUTTING PLIER</i>		XIV - 27
<b>JAYLE</b>	VAGINAL BLADE	VIII - 41
	VAGINAL SPECULUM	VIII - 35
<b>JEANNINGS</b>	MOUTH GAG	XII - 3
<b>JESCO</b>	UNIVERSAL SCISSORS	III - 40
<b>JOLL</b>	RETRACTOR FOR GOITRE	VII - 89
<b>JONES</b>	TOWEL FORCEPS	IV - 78
<b>JOSEPH</b>	E.N.T. HOOK EXO-LEVER	XII - 35
	E.N.T. RAPS	XII - 34
	E.N.T. RASPATORIES	XII - 35
	E.N.T. SAW	XII - 34
	E.N.T. SCISSORS	III - 56 et XII - 35
	NASAL HOOK	XII - 34
<b>JUDD-ALLIS</b>	GRASPING FORCEPS	IV - 74
<b>JUDET</b>	HAMMER	XIII - 46
<b>K</b>		
<b>KANTROWITZ</b>	LIGATURE FORCEPS - DISSECTORS	IV - 49
<b>KELLY</b>	HAEMOSTATIC FORCEPS	IV - 20, 89
	RETRACTOR	VII - 32
	SCISSORS FOR FISTULA	III - 33
<b>KELLY-RANKIN</b>	HAEMOSTATIC FORCEPS	IV - 21
<b>KERRISSON</b>	PUNCHES FORCEPS	XII - 19
<i>KEY FOR CHUCK</i>		XIV - 3
<i>KIDNEY DISH</i>		XV - 21
<b>KIELAND</b>	OBSTETRICAL FORCEPS	VIII - 21
<b>KIENNY</b>	VEIN HOLDER	VII - 19
<b>KILLIAN</b>	E.N.T. HOOK EXO-LEVER	XII - 32
	E.N.T. SPECULUM	XII - 12
	GOUGE FOR NASAL PARTITION	XII - 26
<b>KILNER</b>	NEEDLE HOLDER	VI - 8
<b>KILNER (RAGNELL)</b>	DELICATE SCISSORS	III - 6
<b>KIRSCHNER</b>	FRAME AND BLADES	VII - 60, 61
	TENSIONER AND KEY	XIII - 101
	WIRE TRACTION BOW, HOOK AND WRENCH	XIII - 101
<b>KLIKENBERG</b>	MISCELLANEOUS SCISSORS	III - 34, 49
<b>KNAPP</b>	FINE SCISSORS	III - 26
<i>KNEE RETRACTOR</i>		XIII - 106, 107
<i>KNEE SCISSORS</i>		XIII - 114
<i>KNEE SUPPORT</i>		XIII - 113
<b>KOCHER</b>	E.N.T. SPATULA	XII - 17
	HAEMOSTATIC FORCEPS	IV - 6 à 8, 87 et XV - 13
	INTESTINAL CLAMP FORCEPS	IV - 60
	RETRACTOR	VII - 25, 26, 29
<b>KOCHER-LANGENBECK</b>	RETRACTOR	VII - 30
<b>KOCHER-WAGNER</b>	RETRACTOR	VII - 31
<b>KOENING</b>	HOOK	XIII - 50
<b>KOGAN</b>	ENDOSPECULAS	VIII - 36
<b>KRISTELLER</b>	VAGINAL BLADE	VIII - 47

## Alphabetical index

### L

<b>LA GRANGE</b>	FINE SCISSORS	III - 26
<b>LABORDE</b>	DILATOR	XII - 5
<b>LAGROT</b>	HAND DERMATOME AND BLADES	I - 7
<b>LAHEY</b>	E.N.T. GRASPING FORCEPS	XII - 7
	RETRACTOR	VII - 26
<b>LAMBERT KAY</b>	ATRAUMA CARDIOVASCULAR FORCEPS FOR AORTIC	V - 13
<b>LAMBOTTE</b>	BONE HOLDING FORCEPS	XIII - 81, 82
	HOOK	XIII - 50
	LEVER	VII - 108
	OSTEOTOME	XIII - 31
	RASPATORY	XIII - 13
	SCREW HOLDER	XIV - 19
	<i>LAMINECTOMY RONGEURS</i>	XI - 12 à 14
<b>LANDANGER</b>	BONE HOLDING FORCEPS	XIII - 89 à 91
	CLIP REMOVING FORCEPS	VI - 1
	DRESSING FORCEPS	IV - 2
	INSTRUMENTS HOLDER	XV - 29
	MENISCUS FORCEPS	XIII - 109
	UTERINE BIOPSY FORCEPS	VIII - 39
<b>LANDAX 101</b>	CLEANING OF INSTRUMENTS	XV - 30
<b>LANE</b>	BONE HOLDING FORCEPS	XIII - 83
	DISSECTING FORCEPS	II - 7
<b>LANGE-HOHMANN</b>	RETRACTOR	VII - 100, 102
<b>LANGENBECK</b>	RETRACTOR	VII - 33
	<i>LAPAROSTAT</i>	VII - 70
<b>LARDENOIS</b>	MALLEABLE BLADE	VII - 7, 8
	<i>LARYNGEAL MIRROR AND HANDLE</i>	XV - 4
<b>LAZAR</b>	MICROSURGERY DISSECTING FORCEPS	X - 11
<b>LE MEE</b>	AURICULAR SPECULUM	XII - 11
<b>LE PETIT</b>	DISSECTING FORCEPS	II - 16
	<i>LEAD HANDS</i>	XIII - 94
<b>LEBSCHÉ</b>	STERNUM CHISEL	XIII - 75
<b>LEES</b>	ATRAUMA CARDIOVASCULAR FORCEPS FOR BRONCHUS	V - 10
<b>LEGUEU</b>	CLAMP FORCEPS	IV - 37
	FORCEPS FOR BILE DUCTS	IX - 4
<b>LEKSELL-STILLE</b>	BONE RONGEUR FORCEPS	XIII - 62
<b>LELAND-JONES</b>	ATRAUMA CARDIOVASCULAR FORCEPS	V - 6
<b>LEMAIRE</b>	RASP	XIII - 115
<b>LEMPERT</b>	BONE RONGEUR FORCEPS	XIII - 55
	E.N.T. HOOK EXO-LEVER	XII - 33
	<i>LENGTH GAUGE FOR CANNULATED SCREW</i>	XIV - 45
<b>LEPAGE</b>	OVUM FORCEPS	VIII - 16
<b>LERICHE</b>	BLADE	VII - 41
	DISSECTOR (SPATULA)	XIII - 17
	HAEMOSTATIC FORCEPS	IV - 16, 87 et XV - 14
	HOOK	VII - 17
<b>LERICHE-BUGATTI</b>	BLADE	VII - 41
<b>LERMOYER</b>	ADENOIDS CURETTES	XII - 15
<b>LETOURNEL</b>	BONE CHISEL	XIII - 23
	GOUGE	XIII - 23
	<i>LEVER FOR SHOULDER</i>	XIII - 111
<b>LEWIS</b>	E.N.T. RAPS	XII - 29
<b>LEXER</b>	DISSECTING SCISSORS	III - 12
	OSTEOTOME	XIII - 34
<b>LIEGE</b>	GRASPING FORCEPS	IV - 75
	<i>LIGATURE FORCEPS - DISSECTORS</i>	IV - 40 à 55
	<i>LIGATURE FORCEPS - SEPARATOR</i>	IV - 53 à 59
	<i>LIGATURE NEEDLE</i>	VI - 21, 22, 24
<b>LIMA</b>	E.N.T. CURETTE	XII - 37
<b>LIPSETT</b>	E.N.T. RAPS	XII - 28
<b>LISTER (CROIX ROUGE)</b>	BANDAGE SCISSORS	III - 19, 47 et XV - 10
<b>LISTON</b>	AMPUTATION KNIFE	XIII - 4
	CUTTING FORCEPS	XIII - 66, 67, 70, 71
	SHEAR	XIII - 67
<b>LITTAUER</b>	LIGATURE CUTTING SCISSORS	III - 28
<b>LOCHARD</b>	CAPSULE OPENING FORCEPS	IV - 83
<b>LOCKLIN</b>	FINE SCISSORS	III - 30
<b>LOMBARD</b>	BONE RONGEUR FORCEPS	XIII - 55
	<i>LONG FINE SCISSORS</i>	III - 31 à 33, 46, 53
	<i>LONG HAEMOSTATIC FORCEPS</i>	IV - 23 à 28, 39, 90
<b>LORNA</b>	TOWEL FORCEPS	IV - 81
<b>LORTAT-JACOB</b>	INSTRUMENTS HOLDER FRAME	XV - 29
	<i>LOTION BOWL</i>	XV - 21
<b>LOUTE</b>	TIGHTENER FOR WIRE	XIII - 93
<b>LOVE-GRUENWALD</b>	LAMINECTOMY RONGEURS	XI - 12
<b>LOVELACE</b>	GRASPING FORCEPS	IV - 70



## Alphabetical index

<b>LOWE</b>	ROOTS RETRACTOR	VII - 14
<b>LOWMAN-HOGLUND</b>	BONE HOLDING FORCEPS	XIII - 93
<b>LUBET-BARBON</b>	E.N.T. GRASPING FORCEPS	XII - 9
<i>LUBRIFICANT</i>		XV - 30
<b>LUC</b>	E.N.T. GRASPING FORCEPS	XII - 8
<b>LUCAE</b>	E.N.T. FROCEP	II - 32
	MICROSURGERY HOOKS	X - 20
<b>LUCAS-CHAMPIONNIERE</b>	BONE CHISEL	XIII - 26
	HAND DRILL	XIV - 31
<b>LUER</b>	BONE RONGEUR FORCEPS	XIII - 64
	RETRACTOR	VII - 33
<b>LUER-FRIEDMANN</b>	BONE RONGEUR FORCEPS	XIII - 61
<i>LUER-LOCK TIP</i>		XV - 24
<i>LYMPHOGRAPHIA CLAMP</i>		V - 3
<b>M</b>		
<b>MAC EVEN</b>	MALLET	XIII - 44, 45
	OSTEOTOME	XIII - 29
<b>MAC INDOE</b>	CUTTING FORCEPS	XIII - 68
<b>MAC KEE</b>	RETRACTOR	VII - 81
<b>MAC PHERSON</b>	MICROSURGERY DISSECTING FORCEPS	X - 10
<b>MAGILL</b>	CATHETER FORCEPS	XV - 5
<i>MALLEABLE BLADE</i>		VII - 7, 8
<i>MALLEABLE BLADE ON HANDLE</i>		VII - 9, 10
<i>MALLEABLE HAND</i>		XIII - 94
<i>MALLEABLES SPLINTS</i>		XV - 19
<i>MALLET AND MASS</i>		XIII - 43 à 46
<b>MANGIAGALLI</b>	VAGINAL BLADE	VIII - 46
<b>MARKHAM-MEYERDING</b>	RETRACTOR	VII - 92
<b>MARTIN</b>	RETRACTOR	VII - 34
<b>MASING</b>	E.N.T. HOOK EXO-LEVER	XII - 32
	NEEDLE HOLDER	VI - 8
<b>MATHIEU</b>	UTERINES FORCEPS (POLYPUS)	VIII - 7
<b>MAURER</b>	COSTOTOME	XIII - 73
	RASPATORY	XIII - 14
<b>MAYO</b>	DISSECTING FORCEPS	II - 12
	DISSECTING SCISSORS	III - 7, 42, 50 et XV - 11
	INSTRUMENTS PINS	XV - 29
	VAGINAL SCISSORS	VIII - 67
<b>MAYO-ALSACE</b>	DISSECTING SCISSORS	III - 9
<b>MAYO-HARRINGTON</b>	DISSECTING SCISSORS	III - 10
<b>MAYO-HEGAR</b>	NEEDLE HOLDER	VI - 7, 10, 11 et XV - 13
<b>MAYO-LEGER</b>	DISSECTING SCISSORS	III - 9
<b>MAYO-LEXER</b>	DISSECTING SCISSORS	III - 43, 50
<b>MAYO-LYON</b>	DISSECTING SCISSORS	III - 9
<b>MAYO-NOBLE</b>	DISSECTING SCISSORS	III - 10
<b>MAYO-ROBSON</b>	INTESTINAL CLAMP FORCEPS	IV - 58
<b>MAYO-SANTY</b>	DISSECTING SCISSORS	III - 10
<b>MAYO-STILLE</b>	DISSECTING SCISSORS	III - 8, 50
<b>MC INDOE</b>	DISSECTING FORCEPS	II - 18
<b>MEAD</b>	BONE RONGEUR FORCEPS	XIII - 65
<b>MEEKER</b>	LIGATURE FORCEPS - DISSECTORS	IV - 51
<i>MEMBRANE PUNCH</i>		VIII - 49
<i>MENISCUS FORCEPS</i>		XIII - 109, 110
<i>MENISCUS HOOK</i>		XIII - 112
<i>MENISCUS HOOK</i>		XIII - 112
<i>MENISCUS INSTRUMENT</i>		XIII - 106
<i>MENISCUS SCISSORS</i>		XIII - 109
<b>MERIAM</b>	DISSECTING FORCEPS	II - 22
<b>MERLE D'AUBIGNE</b>	QUADRANGULAR POINT	XIII - 48
	RASPATORY	XIII - 12
	RETRACTOR	VII - 104, 105
	SHOULDER RETRACTOR (BANKART)	XIII - 97, 98
	TRIANGULAR POINT	XIII - 48
	WIRE GUIDE (BANKART)	XIII - 97
<b>MERVEILLEUX</b>	SCISSORS FOR VASCULAR SURGERY	III - 55
<i>METAL AMNIOSCOPE</i>		VIII - 29
<b>METZENBAUM</b>	DISSECTING SCISSORS	III - 13, 14, 44, 51 et XV - 12
<b>METZENBAUM-FINO</b>	DISSECTING SCISSORS	III - 15, 45, 46, 51
<b>MEYERDING</b>	RETRACTOR	VII - 13
<b>MICHEL</b>	CLIP APPLYING FORCEPS	VI - 3
	CLIP APPLYING AND REMOVING FORCEPS	VI - 2
	CLIP REMOVING FORCEPS	VI - 2
	SUTURE CLIPS	VI - 4
<b>MICHON</b>	CLAMP FORCEPS	IV - 37
<i>MICRO DISSECTING FORCEPS</i>		II - 27
<b>MICRO-ADSON</b>	DISSECTING FORCEPS	II - 17
<b>MICRO-HALSTEAD</b>	HAEMOSTATIC FORCEPS	IV - 12

## Alphabetical index

<b>MICRO-MOSQUITO</b>	HAEMOSTATIC FORCEPS	IV - 13
<b>MICRO-RYDER</b>	NEEDLE HOLDER	VI - 14
<i>MICROSURGERY DISSECTING FORCEPS</i>		X - 10 à 12
<i>MICROSURGERY HOOKS</i>		X - 17 à 20
<i>MICROSURGERY NEEDLE HOLDER</i>		X - 1 à 5
<i>MICROSURGERY SCISSORS</i>		X - 6 à 9
<b>MIDDELDORPF</b>	RETRACTOR	VII - 45, 46
<b>MIKULICZ</b>	PERITONEAL FORCEPS	IV - 32
	RETRACTOR	VII - 36
<b>MILLER</b>	E.N.T. RAPS	XII - 30
<b>MILLIN</b>	FORCEPS FOR BILE DUCTS	IX - 4
<i>MINI HANDLE WITH CHUCKS</i>		XIV - 3
<b>MINI-FRIEDMANN</b>	BONE RONGEUR FORCEPS	XIII - 61
<b>MINI-LANGENBECK</b>	RETRACTOR	VII - 11
<b>MINI-TOWNSEND</b>	UTERINE BIOBSY FORCEPS	VIII - 37
<i>MIOMA SCREW</i>		VIII - 49
<b>MIRIZZI</b>	FORCEPS FOR BILE DUCTS	IX - 1, 2
<i>MISCELLANEOUS SCISSORS</i>		III - 18, 25, 34, 39, 49 et VIII - 65
<b>MOHR</b>	TUBING FORCEPS	IV - 84
<b>MONOD</b>	TROCAR	XV - 26
<b>MOORE</b>	ADENOIDS CURETTES	XII - 16
	E.N.T. SHEAR FORCEPS	XII - 22
<b>MOORE LAMBOTTE</b>	T-SHAPED' EXTRACTOR	VII - 108
<b>MOREL-FATIO</b>	RASPATORY	XIII - 15
<b>MORRIS</b>	RETRACTOR	VII - 35
<b>MORRIS-DE BAKEY</b>	ATRAUMA CARDIOVASCULAR FORCEPS FOR AORTIC	V - 15
<b>MOSQUITO</b>	HAEMOSTATIC FORCEPS	IV - 11
<b>MOSQUITO-DANDY</b>	HAEMOSTATIC FORCEPS	IV - 17
<i>MOUTH GAG</i>		XII - 1 à 4
<b>MOYNIHAN</b>	LONG HAEMOSTATIC FORCEPS	IV - 28
<b>MULLER</b>	PHLEBECTOMY HOOK	V - 29
<i>MULTISERVICES FORCEPS</i>		XIV - 22
<b>MURPHY</b>	KNEE SCISSORS	XIII - 114
	TUBING FORCEPS	IV - 85 et XV - 15
<b>MUSEUX</b>	FORCEPS WITH LONG TRAMMEL	XIII - 80
	UTERINES FORCEPS	VIII - 4, 5
<b>MUSEUX PALMER</b>	UTERINES FORCEPS	VIII - 6
<b>MUSEUX PALMER-CHERON</b>	UTERINES FORCEPS	VIII - 6
<b>N</b>		
<b>NAGELE</b>	OBSTETRICAL FORCEPS	VIII - 22
<i>NAIL CUTTERS</i>		XV - 6, 15
<i>NAIL DEPTH GAUGE</i>		XIV - 41
<i>NAIL EXTRACTOR</i>		XIV - 36
<i>NAIL INSERTER</i>		XIV - 38
<i>NAIL SCISSORS</i>		XV - 6, 10
<b>NAKATA PAUCHET</b>	SUTURE NEEDLE	VI - 22
<b>NANCY</b>	GOUGE	XIII - 35
	MISCELLANEOUS SCISSORS	III - 18
<i>NASAL HOOK</i>		XII - 31, 34
<i>NEEDLE FOR KNEECAP</i>		XIII - 115
<i>NEEDLE HOLDER</i>		VI - 5 à 16 et XV - 13, 14
<i>NEEDLES FOR FOREIGN BODIES</i>		XII - 14
<b>NEGUS</b>	GRASPING FORCEPS	IV - 57
<b>NELATON</b>	DIRECTOR	XV - 8
	HAND PERFORATEUR AND DRILLS	XIV - 31
	SCALPEL	I - 1
<i>NEUROSURGERY DISSECTOR</i>		XI - 10, 11
<b>NICOLLET-KOCHER</b>	MENISCUS FORCEPS	XIII - 109
<b>NICOLLET-MUSEUX</b>	MENISCUS FORCEPS	XIII - 108
<b>NOTTER</b>	MEMBRANE PUNCH	VIII - 49
<b>NOVACK</b>	CURETTE PROBE	VIII - 58
<b>NUBOER</b>	SUCTION CANNULA	XV - 23
<b>O</b>		
<i>OBSTETRICAL FORCEPS</i>		VIII - 19 à 23
<b>OCHSNER</b>	ATRAUMA CARDIOVASCULAR FORCEPS FOR AORTIC	V - 8
<b>ODWYER</b>	MOUTH GAG	XII - 1
<i>OLIVAIRE PROBES</i>		XV - 8
<b>OLIVECRONA</b>	SPATULA FOR NEUROSURGERY	XI - 4
	WIRE SAW	XIII - 7
<b>OLIVIER</b>	RETRACTOR, CHAIN AND HOOD	VII - 59
<b>OLLIER</b>	BONE HOLDING FORCEPS	XIII - 78, 79
	POINT	XIII - 111
	RASPATORY	XIII - 10
	RETRACTOR	VII - 28
<b>OMBREDANNE</b>	BONE CHISEL	XIII - 28
	GRASPING FORCEPS	IV - 33
	MALLET	XIII - 43

# Alphabetical index

<b>OMBREDANNE</b>	SQUARE POINT	XIII - 47
<i>OPEN-END WRENCH</i>		XIV - 17
<i>OPHTHALMOLOGIC DISSECTING FORCEPS</i>		II - 29
<b>ORDINAIRE</b>	BULLDOG CLAMP	V - 3
<b>O'SHAUGNESSY</b>	LIGATURE FORCEPS - DISSECTORS	IV - 41 à 45
<i>OSTEOTOME</i>		XIII - 29 à 34
<i>OVAL JAW FORCEPS</i>		IV - 66, 71
<i>OVARIAN FORCEPS</i>		VIII - 17
<b>OVERHOLT-GEISSENDORFER</b>	LIGATURE FORCEPS - DISSECTORS	IV - 46
<b>OVERHOLT-SLIM</b>	LIGATURE FORCEPS - DISSECTORS	IV - 47
<i>OVUM FORCEPS</i>		VIII - 16, 17
<b>P</b>		
<i>PAD FOR TOURNIQUET</i>		V - 29
<b>PAJOT</b>	OBSTETRICAL FORCEPS	VIII - 21
<b>PALMER</b>	RETRACTOR	VII - 58
	UTERINES FORCEPS (POLYPUS)	VIII - 8
	VAGINAL SPECULUM	VIII - 34
<b>PALMER (BOWMAN)</b>	E.N.T. SPECULUM	XII - 11
<i>PARACENTESIS NEEDLES</i>		XII - 14
<i>PARALLEL JAWS FORCEPS</i>		XIV - 21
<i>PARAMETER FORCEPS</i>		VIII - 13
<b>PARKER-LANGENBECK (US ARMY)</b>	RETRACTOR	VII - 48
<b>PAUCHET</b>	CLIP APPLYING FORCEPS	VI - 3
	PLIER FORCEPS	IV - 34
	SABER NEEDLE	VI - 22
<b>PAUWELLS</b>	OSTEOTOME	XIII - 30
<b>PAYR</b>	INTESTINAL CLAMP FORCEPS	IV - 61
<b>PEAN</b>	DRESSING FORCEPS	IV - 1 et XV - 12
<i>PEDIATRIC CLAMP</i>		V - 26 à 28
<b>PEERS</b>	TOWEL FORCEPS	IV - 80
<b>PEET</b>	SLINTER FORCEPS	IV - 33
<i>PEG FOR OPERATING TABLE</i>		VII - 51
<b>PENNINGTON</b>	E.N.T. RASPARTORIES	XII - 27
	GRASPING FORCEPS	IV - 69
<i>PERCUSSION HAMMER</i>		XV - 1
<b>PERCY</b>	RETRACTOR FOR AMPUTATION	XIII - 8
<i>PERIOSTOMY RASPARTORY</i>		XIII - 11
<i>PERITONEAL FORCEPS</i>		IV - 32
<b>PERRY</b>	DISSECTING FORCEPS	II - 24
<i>PHLEBECTOMY HOOK</i>		V - 29
<i>PIN CUTTING PLIER</i>		XIV - 27
<i>PLASTER CAST SPREADER</i>		XV - 18
<i>PLASTER SCISSORS</i>		XV - 17
<i>PLASTIC CLAMP</i>		XV - 16
<i>PLASTIC DRESSING FORCEPS</i>		XV - 16
<i>PLATE BENDER FOR NAILS</i>		XIV - 37
<i>PLATE BENDER FOR PLATES</i>		XIV - 14
<i>PLATE BENDING PLIERS</i>		XIV - 15, 16
<i>PLATE TO STRETCH THE SKIN</i>		I - 6
<i>PLEXIGLAS AMNIOSCOPE</i>		VIII - 29
<i>PLIER FORCEPS</i>		IV - 34
<i>PLUG FOR FRAME</i>		VII - 63
<i>PLYERS FOR MALLEABLE BLADES</i>		VII - 64
<b>POIRIER</b>	BONE CHISEL	XIII - 26
	GOUGE	XIII - 36
<i>POLISH RUBBER</i>		XV - 30
<b>POLITZER</b>	E.N.T. FROCEP	II - 31
<b>POLOSSON</b>	BLADE	VII - 38, 39
<i>POSITIONING PLATE</i>		XIV - 12, 13
<b>POST AVORTUM</b>	OVUM FORCEPS	VIII - 16
<b>POSTEL</b>	HANDSAW AND BLADE	XIII - 4
	RETRACTOR	VII - 108
<b>POTTS-SMITH</b>	DISSECTING FORCEPS	II - 20, 36
	SCISSORS FOR VASCULAR SURGERY	III - 21, 54
<b>POZZI</b>	SHOULDER FORCEPS (BANKART)	XIII - 98
	UTERINES FORCEPS	VIII - 9
<b>POZZI-PALMER</b>	UTERINES FORCEPS	VIII - 9
<b>PRATT</b>	HEMORRHOIDAL CLAMP	IV - 77
<b>PRICE-THOMAS</b>	CLAMP FORCEPS FOR BRONHUS	IV - 62
<b>PRIMA</b>	STERILE SUTURE CUTTING SCALPEL	I - 5
<i>PROBE FOR BILE DUCTS</i>		IX - 6
<i>PROSTATIC RETRACTOR</i>		VII - 43
<b>PROVIDENCE</b>	HAEMOSTATIC FORCEPS	IV - 17
<i>PUNCH</i>		XIII - 49, 112
<i>PUNCHES FORCEPS</i>		XI - 15 à 17 et XII - 19, 21
<b>Q</b>		
<i>QUADRANGULAR POINT</i>		XIII - 48

## Alphabetical index

<b>QUENU</b>	DISSECTING FORCEPS	II - 15
	INTESTINAL CLAMP FORCEPS	IV - 56
<i>QUICK LOCKING HANDLE</i>		XIV - 3
<b>QUILICY-FARISSE</b>	LIGATURE FORCEPS - DISSECTORS	IV - 50
<b>QUIRE</b>	FORCEPS LOOSE FOREIGN BODY	X - 15
<b>R</b>		
<b>RAGNEL</b>	RETRACTOR	VII - 19
<i>RASP</i>		XIII - 115
<i>RASPATORY</i>		XIII - 9 à 16, 112
<i>RASPATORY FOR SCIATIC</i>		XI - 1
<i>RASPATORY FOR TENDONS</i>		XIII - 1
<i>RASPATORY FOR YELLOW LIGAMENT</i>		XIII - 15
<i>RAZOR BLADE</i>		X - 20
<i>REAMER AND NAILS TEMPLATE</i>		XIV - 41
<i>REAMER FOR SCREWS</i>		XIV - 4
<b>RECAMIER</b>	UTERINE CURETTE	VIII - 56
<i>RECTAL RETRACTOR</i>		VIII - 27, 28
<i>RECTAL SPECULUM</i>		VIII - 26
<i>RECTANGULAR TRAY</i>		XV - 21
<b>REDON</b>	LIGATURE FORCEPS - DISSECTORS	IV - 40
	NEEDLE	VI - 23
<i>RENAL CLAMP</i>		IV - 36
<b>RESANO</b>	INTESTINAL CLAMP FORCEPS	IV - 55
<i>RESECTION BONE HOLDING FORCEPS</i>		XIII - 78
<i>RETRACTOR FOR AMPUTATION</i>		XIII - 8
<i>RETRACTOR FOR BILE DUCTS</i>		IX - 7
<i>RETRACTOR FOR FOREARM</i>		VII - 106
<i>RETRACTOR FOR GOITRE</i>		VII - 89
<i>RETRACTOR FOR HEMILAMINECTOMIE</i>		VII - 93, 94
<i>RETRACTOR FOR ROOTS</i>		XI - 6
<b>REVERDIN</b>	SUTURE NEEDLE	VI - 20
<b>REYNOLDS</b>	FINE SCISSORS	III - 31, 53
<i>RIB CONTRACTOR</i>		VII - 76
<i>RIB SHEARS</i>		XIII - 75
<b>RICARD</b>	BLADE	VII - 52
	COMPLETE RETRACTOR	VII - 53
<b>RICARD-BEGOIN</b>	BLADE	VII - 54
	COMPASS	VII - 52
	COMPLETE RETRACTOR	VII - 55
<b>RICHARDSON</b>	RETRACTOR	VII - 32
<b>RICHARDSON-EASTMAN</b>	RETRACTOR	VII - 6
<i>RIGID MEDULLARY REAMER</i>		XIV - 33
<i>RIGID REAMER FOR NAILS</i>		XIV - 37
<i>RING SCREW FOR FRAME</i>		VII - 64
<b>RIZZUTI</b>	NEUROSURGERY DISSECTOR	XI - 10
<b>ROBB</b>	NEUROSURGERY DISSECTOR	XI - 11
<b>ROBERTS</b>	LONG HAEMOSTATIC FORCEPS	IV - 26
<b>ROBIN</b>	CHISEL FOR NASAL PARTITION	XII - 24
<b>ROCHARD</b>	BLADE	VII - 48
	COMPASS	VII - 47
	FORCEPS FOR UTERINE ARTERY	VIII - 16
<b>ROCHER</b>	PUNCH	XIII - 49
<b>ROCHESTER-CARMALT</b>	HAEMOSTATIC FORCEPS	IV - 31
<b>ROCHESTER-OSCHNER</b>	HAEMOSTATIC FORCEPS	IV - 10
<b>ROCHESTER-PEAN</b>	HAEMOSTATIC FORCEPS	IV - 9
<b>ROGERS</b>	PARAMETER FORCEPS	VIII - 13
<i>ROOTS RETRACTOR</i>		VII - 12
<b>ROUENNAIS</b>	MISCELLANEOUS SCISSORS	III - 39
<b>ROUX</b>	RETRACTOR	VII - 4
<b>RUAULT</b>	TONSILLECTOMY KNIFE	XII - 17
<i>RUBBER BANDANGE</i>		XV - 2
<i>RUBBER FOR PERCUSSION HAMMER</i>		XV - 1
<i>RUBBER JAWS - HERCULES</i>		XIV - 28
<i>RUBBER TOURNIQUET</i>		XV - 2
<i>RULER - CALIPER</i>		XIII - 51
<b>RUMEL</b>	LIGATURE FORCEPS - DISSECTORS	IV - 51
<b>RUMMEL-BELMONT</b>	TOURNIQUET AND CHUCK	V - 29
<b>RUSKIN-LISTON</b>	CUTTING FORCEPS	XIII - 69
<b>RYDER</b>	NEEDLE HOLDER	VI - 14
<b>S</b>		
<i>S SHAPE SCISSORS</i>		III - 34
<i>SABER NEEDLE</i>		VI - 22
<b>SANTULLI</b>	BULLDOG CLAMP	V - 2
<b>SANTY</b>	LONG HAEMOSTATIC FORCEPS	IV - 27
	SUCTION CANNULA	XV - 23
<b>SAROT</b>	LONG HAEMOSTATIC FORCEPS	IV - 26
	NEEDLE HOLDER	VI - 15

# Alphabetical index

<b>SATINSKY</b>	CARDIOVASCULAR FORCEPS FOR TANGENTIAL OCCLUSION	V - 13
	S SHAPE SCISSORS	III - 34
<b>SAUERBRUCH</b>	BONE RONGEUR FORCEPS	XIII - 58
	COSTOTOME	XIII - 74
<b>SAUERBRUCH-FREY</b>	COSTOTOME	XIII - 74
	SAW FOR AMPUTATION	XIII - 5, 6
	SAW TO CUT THE RING	XV - 7
	SCALPEL	I - 1
	SCALPEL BLADE	I - 2, 3
	SCALPEL HANDLE	I - 2 à 4
<b>SCHADEL</b>	TOWEL FORCEPS	IV - 78
<b>SCHEIBE</b>	INTESTINAL CLAMP FORCEPS	IV - 58
<b>SCHINK</b>	HAND DERMATOME, BLADES AND PLATE	I - 6
<b>SCHNIDT</b>	LIGATURE FORCEPS - DISSECTORS	IV - 48
<b>SCHROEDER</b>	UTERINES FORCEPS	VIII - 10
<b>SCHUMAKER</b>	UTERINE BIOPSY FORCEPS	VIII - 39
	SCIATIC CURETTE	XI - 1
	SCISSOR FORCEPS	VI - 18
	SCISSORS ENTEROTOME	XIII - 8
	SCISSORS FOR COTTON	III - 39
	SCISSORS FOR FISTULA	III - 33
	SCISSORS FOR LOBECTOMY	III - 35
	SCISSORS FOR STRABISMUS	III - 4
	SCISSORS FOR UMBILICAL CORD	VIII - 65
	SCISSORS FOR VASCULAR SURGERY	III - 21 à 24, 54, 55
	SCISSORS TO TAKE CAPSULES OFF	XIII - 92
	SCOOP FOR BILE DUCTS	IX - 6
	SCRAPPER	XIII - 25
	SCREW DRIVER	XIV - 5 à 7
	SCREW DRIVER - HOLDING SLEEVE	XIV - 6
	SCREW DRIVER AND HANDLE	XIV - 6, 7
	SCREW DRIVER FOR CANNULATED SCREW	XIV - 44
	SCREW HOLDER	XIV - 19
	SCREW SYSTEM FOR OBSTETRICAL FORCEPS	VIII - 20
<b>SEBILEAU</b>	E.N.T. CURETTE	XII - 39
	E.N.T. RASPATORIES	XII - 27
<b>SEGURA</b>	E.N.T. MALLETT	XII - 37
<b>SEMB</b>	BONE HOLDING FORCEPS	XIII - 80
	LIGATURE FORCEPS - DISSECTORS	IV - 52
	RASPATORY	XIII - 12
<b>SEMB-SAYLOR</b>	LIGATURE FORCEPS - DISSECTORS	IV - 52
<b>SEMKEN</b>	DISSECTING FORCEPS	II - 26
<b>SENN-MILLER</b>	RETRACTOR	VII - 19
	SEQUESTER FORCEPS	XIII - 87
	SHARP SCISSORS	III - 2, 41 et XV - 11
	SHEAR	XIII - 67
	SHOULDER FORCEPS (BANKART)	XIII - 97
	SHOULDER RETRACTOR (BANKART)	XIII - 97, 98
<b>SHUBERT</b>	UTERINE BIOPSY FORCEPS	VIII - 40
<b>SICARD</b>	BONE RONGEUR FORCEPS	XIII - 59
<b>SICART</b>	SPATULA FOR CIATIC	XI - 1
<b>SIEBOLD</b>	S SHAPE SCISSORS	III - 34
	SILICONE PROTECTION	XII - 4
	SILICONE VALVE	VII - 8
<b>SIMON</b>	RETRACTOR	VII - 34
	UTERINE CURETTE	VIII - 52
<b>SIMS</b>	RECTAL SPECULUM	VIII - 26
	SCALPEL	I - 1
	UTERINE CURETTE	VIII - 53
	UTERINE SCISSORS	III - 36, 49, 56
	UTERINE SOLIND	VIII - 64
<b>SINGLEY-TUTTLE</b>	DISSECTING FORCEPS	II - 16
<b>SISTERON</b>	FORCEPS FOR BILE DUCTS	IX - 3
	SLOTTED HAMMER	XIV - 11, 35
<b>SLUDDER-BALLENGER</b>	TONSILLOTOME AND BLADES	XII - 18
<b>SMILLIE-TRILLAT</b>	GUIDE WITH CANON FOR KNEE	XIII - 110
	KNEE RETRACTOR	XIII - 106, 107
	MENISCUS INSTRUMENT	XIII - 105
<b>SMITH-PETERSEN</b>	BONE RONGEUR FORCEPS	XIII - 62
	GOUGE	XIII - 38
<b>SNELLEN</b>	E.N.T. CURETTE	XII - 38
	SOCKET WRENCH	XIV - 17
	SPARE CYLINDER FOR SYRINGE	XV - 27
	SPATULA	XIII - 99
	SPATULA FOR NEUROSURGERY	XI - 3 à 5
	SPATULA FOR SCIATIC	XI - 2
	SPATULES (OBSTETRICAL FORCEPS)	VIII - 22, 23

## Alphabetical index

<i>SPECIAL HAEMOSTATIC FORCEPS</i>		IV - 29 à 32
<b>SPENCER</b>	LIGATURE CUTTING SCISSORS	III - 27
<b>SPENCER-FINO</b>	LIGATURE CUTTING SCISSORS	III - 28
<b>SPENCER-WELLS</b>	HAEMOSTATIC FORCEPS	IV - 4, 5
<i>SPLINTERS FORCEPS</i>		II - 24, 27, 28 et IV - 33
<b>SPURLING</b>	LAMINECTOMY RONGEURS	XI - 12
<i>SQUARE POINT</i>		XIII - 47
<b>STAGNARA</b>	GOUGE	XIII - 41
<i>STAINLESS WIRE FOR SNARE</i>		XII - 13
<b>STAMEY</b>	NEEDLE	VI - 22
<i>STAPLES DRIVER</i>		XIV - 46
<i>STAPLES EXTRACTOR</i>		XIV - 46
<i>STAPLES INSERTER</i>		XIV - 46, 47
<b>STEIMANN</b>	TENDON'S FORCEPS	XIII - 2
<i>STERILE SCALPEL</i>		I - 5
<i>STERNUM CHISEL</i>		XIII - 75
<b>STEVENS</b>	FINE SCISSORS	III - 29, 53
<b>STILLE</b>	BONE CHISEL	XIII - 28
	BONE RONGEUR FORCEPS	XIII - 56
	CLAMP FORCEPS	IV - 35
	GOUGE	XIII - 37
	OSTEOTOME	XIII - 34
<i>STITCH CUTTER</i>		I - 5
<i>STITCH CUTTER BLADE</i>		I - 2, 5
<b>STRASBOURG</b>	DISSECTING FORCEPS WITH HEELS	II - 8
<b>STRATT</b>	NEEDLE HOLDER	VI - 12
<b>STRAUSS</b>	URETRE'S COMPRESSOR	IX - 8
<b>STRELI</b>	NEEDLE HOLDER	VI - 5
<b>STRULLY</b>	LONG FINE SCISSORS	III - 33
<b>SUBRAMANIAN</b>	ATRAUMA CARDIOVASCULAR FORCEPS FOR AORTIC	V - 22
<i>SUCTION CANNULA</i>		XV - 23
<i>SUPPORT FOR BLADE</i>		VII - 65
<i>SUTURE CLIPS</i>		VI - 4
<i>SUTURE MICRO FORCEPS</i>		II - 27
<i>SUTURE NEEDLE</i>		VI - 20, 23
<i>SYRINGE</i>		VIII - 58 et XV - 27
<i>SYRINGE SEAL</i>		VIII - 58
<b>T</b>		
<i>T HANDLE WITH CHUCK</i>		XIV - 3
<b>TAKA-ASHI</b>	E.N.T. RAPS	XII - 28
<b>TAKAHASHI</b>	BONE RONGEURS	XII - 20
<i>TAMPING TOOL</i>		XIII - 100
<i>TAP DRILL GUIDE</i>		XIV - 8
<i>TAP FOR CANNULATED SCREW</i>		XIV - 42
<i>TAPS</i>		XIV - 2
<i>TARGET DEVICE FOR GUIDE PIN</i>		XIV - 43
<b>TARNIER</b>	OBSTETRICAL FORCEPS AND TRACTION HANDLE	VIII - 19
<b>TAYLOR</b>	DISSECTING FORCEPS	II - 21
	RETRACTOR FOR ROOTS	XI - 6
<i>TEETH FOR BECKMANN</i>		VII - 86
<b>TEISSIER</b>	STATULAS AND TRACTION HANDLE	VIII - 23
<i>TEMPLATE BENDING FOR PLATES</i>		XIV - 14
<i>TENDON'S FORCEPS</i>		XIII - 2, 3
<i>TENDON'S HOOK</i>		XIII - 2
<i>TENOTOME</i>		I - 1
<i>TENSION DEVICE FOR PLATE</i>		XIV - 17
<i>TENSIONER FOR WIRE TRACTION BOW</i>		XIII - 101
<b>TERRIER</b>	HAEMOSTATIC FORCEPS	IV - 4
	MOUTH GAG	XII - 1
<b>THERUM</b>	COIL FORCEPS	VIII - 51
<b>THIERRY</b>	SPATULES (OBSTETRICAL FORCEPS)	VIII - 22
<i>TISSUE PROTECTOR SLEEVE FOR CANNULATED SCREW</i>		XIV - 43
<b>TISHLER-MORGAN</b>	BIOSBY FORCEPS	VIII - 37
<b>TOENNIS</b>	LONG FINE SCISSORS	III - 32, 46
<b>TOENNIS-ADSON</b>	LONG FINE SCISSORS	III - 32
<b>TOHOKU</b>	TOWEL FORCEPS	IV - 81
<i>TONGUE DEPRESSOR</i>		XV - 3
<i>TONSILLECTOMY KNIFE</i>		XII - 17
<b>TROUPET</b>	CLAMP FORCEPS	IV - 38
	DOUBLE DEPRESSOR	VII - 56
	PEG, CHAIN AND CURSOR	VII - 51
<i>TOWEL FORCEPS</i>		IV - 78 à 81 et XV - 15
<b>TRELAT</b>	ANAL DILATOR	VIII - 25
<i>TREPAN CROWN</i>		XI - 7
<i>TRIANGULAR JAW FORCEPS</i>		IV - 66, 71
<i>TRIANGULAR POINT</i>		XIII - 48
<b>TRILLAT</b>	MENISCUS HOOK	XIII - 112

## Alphabetical index

<b>TRILLAT</b>	MENISCUS HOOK	XIII - 112	
	RASPATORY	XIII - 112	
	RETRACTOR FOR FOREARM	VII - 106	
	RETRACTOR FOR SHOULDER	XIII - 111	
	TROCAR	XIII - 112	
<i>TROCAR</i>		XIII - 112 et XV - 25	
<i>TROCAR WITH SLEEVE</i>		XIV - 39	
<b>TROELTSCH</b>	E.N.T. FROCEP	II - 30	
<b>TROUSSEAU</b>	DILATOR	XII - 5	
	<i>T-SHAPED EXTRACTOR</i>	VII - 108	
<b>TUBIANA</b>	NEEDLE HOLDER	VI - 5	
	<i>TUBING FORCEPS</i>	IV - 83 à 85 et XV - 15	
	<i>TUBULAR WIRE GUIDE</i>	XIII - 100 et XIV - 48	
<b>TUFFIER</b>	GRASPING FORCEPS	IV - 75	
	RETRACTOR	VII - 76	
	<i>TUNGSTEN JAW - HERCULES</i>	XIV - 28 à 30	
<b>U</b>			
<b>ULTRA-ASEPT</b>	SYRINGE AND SPARE CYLINDER	XV - 27	
<i>UMBILICAL CLAMP</i>		VIII - 50	
<i>UNIVERSAL CUTTING FORCEPS</i>		XIV - 25	
<i>UNIVERSAL FORCEPS</i>		XIV - 21	
<i>UNIVERSAL SCISSORS</i>		III - 40	
<b>UNIVERSEL</b>	WIRE CUTTING SCISSORS	III - 20, 47	
<b>UNIVERSELLE</b>	CUTTING FORCEPS	XIV - 25	
	FORCEPS	XIV - 21	
	COMEDONE EXTRACTOR	XIII - 25	
<b>UNNA</b>	<i>URETRE'S COMPRESSOR</i>	IX - 8	
	<i>URINAL</i>	XV - 20	
	<i>UTERINE BIOBSY FORCEPS</i>	VIII - 37 à 40	
	<i>UTERINE CURETTE</i>	VIII - 52 à 57	
	<i>UTERINE DILATOR</i>	VIII - 61 à 63	
	<i>UTERINE ELEVATING FORCEPS</i>	VIII - 18	
	<i>UTERINE SCISSORS</i>	III - 36, 49, 56	
	<i>UTERINE SOLIND</i>	VIII - 64	
	<i>UTERINES FORCEPS</i>	VIII - 4 à 17	
	<i>UTERINES FORCEPS (POLYPUS)</i>	IV - 75 et VIII - 7, 8 et X - 14	
	<b>V</b>		
	<b>VACHER</b>	E.N.T. SNARE	XII - 13
		E.N.T. SPECULUM	XII - 11
<i>VAGINAL BLADE</i>		VIII - 41 à 48	
<i>VAGINAL SCISSORS</i>		VIII - 67	
<i>VAGINAL SPECULUM</i>		VIII - 30 à 35	
<i>VAGINAL SPECULUM FOR VIRGIN</i>	VIII - 34		
<b>VALLEIX</b>	UTERINE SOUND AND CURSOR	VIII - 64	
<b>VANNAS</b>	MICROSURGERY SCISSORS	X - 6, 7	
	<i>VARIOUS RETRACTORS</i>	VII - 1 à 108 et XIII - 99	
	<i>VASCULAR TOURNIQUET</i>	V - 29	
	<i>VEIN HOLDER</i>	VII - 17	
<b>VELPEAU</b>	RIB SHEARS	XIII - 75	
<b>VERBRUGGE</b>	BONE HOLDING FORCEPS	XIII - 76, 84 à 86	
<b>VERBRUGGE-MULLER</b>	RETRACTOR	VII - 100, 101	
<b>VERNON</b>	PERCUSSION HAMMER	XV - 1	
<b>VERWYNIL</b>	FRAME, BLADES AND KNOB	VII - 63	
<b>VEZIEN</b>	SCISSORS	VIII - 65	
	<i>VICE FOR FRAME</i>	VII - 64	
	<i>VICE FORCEPS</i>	XIV - 21	
<b>VIDAL</b>	SCRAPPER	XIII - 25	
<b>VINCENT</b>	BONE RONGEUR FORCEPS	XIII - 59	
	DISSECTING FORCEPS	II - 6, 38	
	MISCELLANEOUS SCISSORS	III - 25	
<b>VINCENT (SCHMIEDEN TAYLOR)</b>			
<b>VOLKMANN</b>	BONE CHISEL	XIII - 19, 20	
	RETRACTOR	VII - 21 à 24	
	UTERINE CURETTE	VIII - 57	
<b>W</b>			
<b>WAGENER</b>	MICROSURGERY HOOKS	X - 18	
<b>WAGNER</b>	DELICATE SCISSORS	III - 5, 52	
<b>WALDMANN</b>	EPISIOTOMY SCISSORS	VIII - 67	
<b>WALLICH</b>	UTERINE CURETTE	VIII - 55	
<b>WALTER-CARMALT</b>	DISSECTING FORCEPS	II - 28	
<b>WALTER-DUVAL</b>	GRASPING FORCEPS	IV - 65	
<b>WALTON</b>	RETRACTOR FOR HEMILAMINECTOMY	VII - 93	
<b>WEBER</b>	ATRAUMA CARDIOVASCULAR FORCEPS FOR AORTIC	V - 12	
	<i>WEIGHT FOR VAGINAL BLADES</i>	VIII - 41	
<b>WEIL-BLAKESLEY</b>	LAMINECTOMY RONGEURS	XI - 14	
<b>WEISS</b>	TUBING FORCEPS	IV - 83	
<b>WEITLANER</b>	RETRACTOR	VII - 78, 79	
<b>WEITLANER NEURO</b>	RETRACTOR	VII - 91	

## Alphabetical index

<b>WEITLANER-WULLSTEIN</b>	RETRACTOR	VII - 90
<b>WERTHEIM (BOZEMANN)</b>	NEEDLE HOLDER	VI - 12
<b>WERTHEIMER</b>	E.N.T. CANNULA	XII - 40
<b>WHITE</b>	E.N.T. GRASPING FORCEPS	XII - 10
<b>WILLIAMS</b>	SCREW DRIVER	XIV - 6
<b>WILLIGER</b>	RASPATORY	XIII - 15
<i>WIRE CUTTING PLIERS</i>		XIV - 25 à 30
<i>WIRE CUTTING SCISSORS</i>		III - 20, 47
<i>WIRE GUIDE</i>		XIII - 111
<i>WIRE GUIDE (BANKART)</i>		XIII - 97
<i>WIRE GUIDE FOR TENDONS</i>		XIII - 1
<i>WIRE PLIERS</i>		VI - 19 et XIV - 23, 24
<i>WIRE SAW</i>		XIII - 7
<i>WIRE SEIZING FORCEPS</i>		XIV - 19
<i>WIRE TRACTION BOW</i>		XIII - 101 à 104
<i>WIRE-STAINER FOR WIRE TRACTION BOW</i>		XIII - 101
<b>WOLF</b>	FORCEPS FOR PLASTER	XV - 18
<i>WOLF PLASTER FORCEPS</i>		XV - 17
<b>Y</b>		
<b>YANKAUER</b>	SUCTION CANNULA	XV - 23
<b>YASARGIL</b>	MICROSURGERY NEEDLE HOLDER	X - 5
	MICROSURGERY SCISSORS	X - 9
<b>Z</b>		
<i>Z SHAPE RETRACTOR</i>		XII - 36



# LANDANGER

1947

## Indications importantes

Ce catalogue reste la propriété de LANDANGER. Nous pouvons demander le retour du catalogue dans le cas où celui-ci n'est pas utilisé conformément à nos intérêts, pour la vente ou l'achat de nos produits. Dans ce cas nous nous réservons le droit de mener des actions juridiques.

La reproduction ou la copie totale de ce catalogue est interdite sans notre accord écrit.  
Sous réserve des modifications techniques.

## Important notice

This catalogue remains property of LANDANGER. We can at any time recall the catalogue, in case that it has been not used according to our interests, i.e. sale or purchase of our products. We preserve the right for further steps in that case.

Reproduction or copying of this catalogue in whole or in parts is forbidden without our written permission.  
Patterns are subject to change.

## Avisos importantes

Este catálogo es la propiedad de LANDANGER. Podemos solicitar la devolución del catálogo en caso de que no sea utilizado para la compra o venta de nuestros productos. En este caso nos reservamos el derecho de tomar medidas jurídicas.

La reproducción o copió total o parcial de este catálogo está prohibida sin nuestro consentimiento escrito.  
Salvo modificaciones técnicas.

## Version 2010-01

Concept and design : LANDANGER - Photos et illustrations non contractuelles.

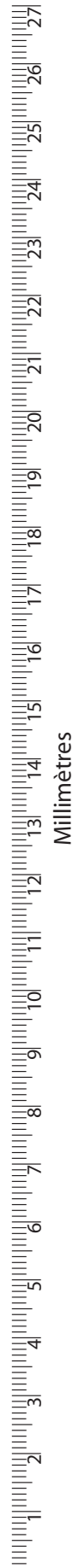



LANDANGER

1947

*Siège - Corporate Office*

13, Avenue de la République - 75011 Paris - France

*Service Clients et Production - Customer Service and Manufacturing*

Z.I. la Vendue - B.P. 2152 - 52906 Chaumont Cedex 9 - France

Tél : +33 (0) 3 25 02 10 10 - Fax : +33 (0) 3 25 02 10 20 - Email : [contact@landanger.com](mailto:contact@landanger.com)  
[www.landanger.com](http://www.landanger.com)



**NEUROCHIRURGIE**  
*NEUROSURGERY*

L A N D A N G E R



# LANDANGER

---

*Notre passion,  
notre histoire,  
créent  
la différence.*

Benoît Landanger

*Our passion, our history, make the difference*

## Logos & Pictos



Échelle des instruments représentés sur la page.  
Scale for the instruments presented on the page.



Pinces ou clamps avec mors DeBakey.  
Forceps or clamps with DeBakey jaws.



Instruments avec parties en Aluminium.  
Instruments with Aluminum parts.



Manches contrebalancés.  
Counterbalanced handles.



Instruments avec mors en Diamonite.  
Instruments with Diamonite jaws.



Instruments avec manches streamline.  
Instruments with streamline handles.



Instruments avec lames ou mors en carbure de tungstène.  
Instruments with tungsten carbide blades or jaws.

## Manches de bistouris - Scalpel handles

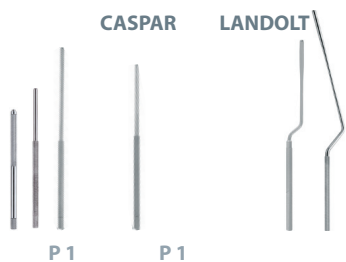

## Lames - Blades

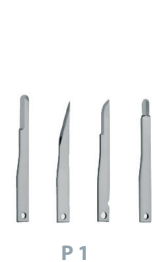

## Instruments pour sciatique - Instruments for sciatic

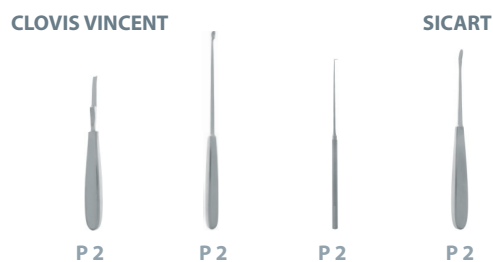

## Rugines et dissecteurs - Raspatories and elevators

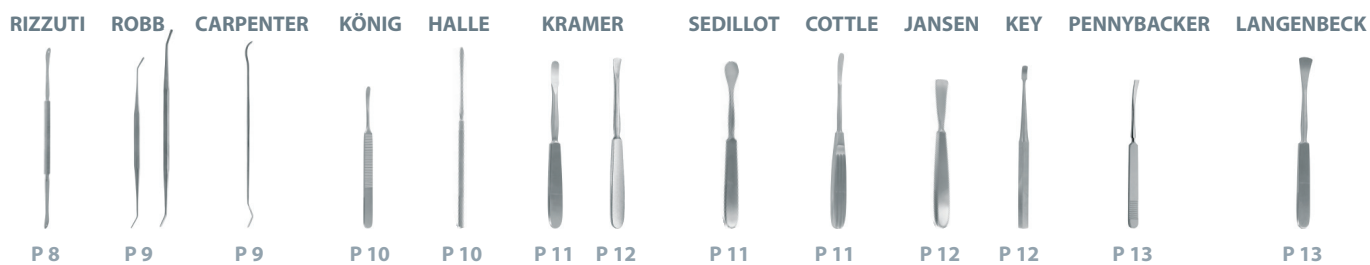
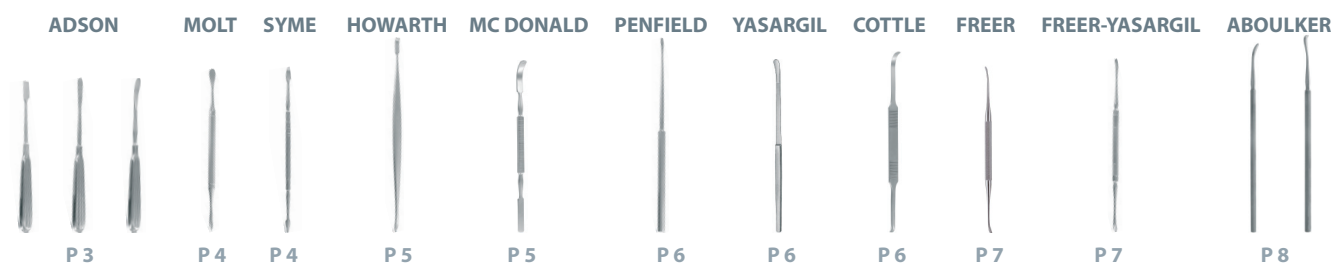

## Crochets - Hooks

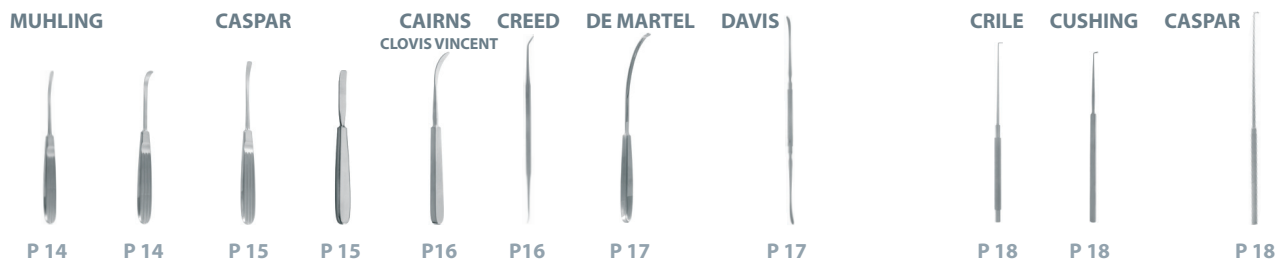

## Curettes osseuses - Bone curettes



## Maillets - Mallets



## Spatules - Spatulas

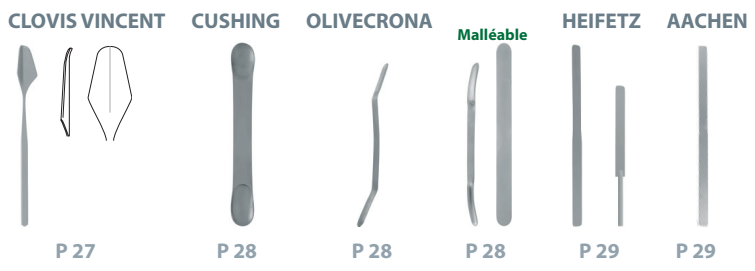

## Écarteurs à nerf - Nerve retractors

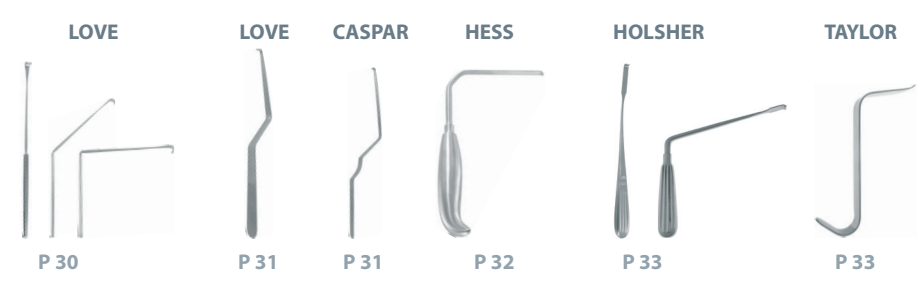





### LANDOLT

Paquet de 10 lames stériles  
Sterile packing unit 10 blades

### CASPAR



**B160013**  
13,5 cm - 5 1/4 "



**B160015**  
15,5 cm - 6 "



**B160080**  
18 cm - 7 "



**B160020**  
20 cm - 8 "



**B160021**  
21 cm - 8 1/4 "



**B160025**  
25 cm - 10 "



N° 64

**B161064**



N° 65

**B161065**



N° 67

**B161067**



N° 69

**B161069**

### CLOVIS VINCENT



- 5 mm **J08030**
- 7 mm **J08031**

- 17 cm - 6 3/4" **J08010**
- 19 cm - 7 1/2" **J080101**



Rugine  
Raspatory

**J08010**  
17 cm - 6 3/4"



Curette  
Curette

**J08030**  
22 cm - 8 3/4"

2 mm



Crochet  
Hook

**J08035**  
19 cm - 7 1/2"



**J08060**  
20 cm - 8"

ADSON



Tranchante  
Sharp

8 mm



**J241910**  
17 cm - 6 <sup>3</sup>/<sub>4</sub> "

Tranchante  
Sharp

7 mm



**J241912**  
17 cm - 6 <sup>3</sup>/<sub>4</sub> "

Mousse  
Blunt

7 mm



**J241911**  
17 cm - 6 <sup>3</sup>/<sub>4</sub> "

Tranchante  
Sharp

7 mm



**J241913**  
17 cm - 6 <sup>3</sup>/<sub>4</sub> "

### MOLT

### SYME



Tranchante  
Sharp

Tranchante  
Sharp

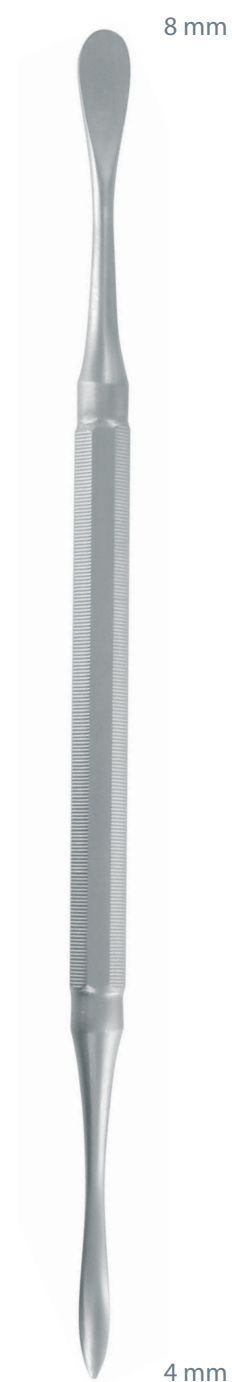

**J235504**  
18 cm - 7"

**J235505**  
18,5 cm - 7 1/4"



HOWARTH

MC DONALD

5 mm



Tranchante  
Sharp

Mousse  
Blunt

6 mm



5 mm

Mousse  
Blunt

6 mm

**J243722**  
21,5 cm - 8 1/2 "

**J243724**  
19 cm - 7 1/2 "

### PENFIELD



**J243725**  
21,5 cm - 8 1/2"

### YASARGIL

Tige flexible  
Flexible rod



**J243726**  
19,5 cm - 7 3/4"

### COTTLE



Tranchante - Tranchante  
Sharp - Sharp



**J243727**  
20 cm - 8"

**FREER**

**FREER-YASARGIL**



Tranchant - Mousse  
Sharp - Blunt

Tranchant - Tranchant  
Sharp - Sharp



**J243720**  
18,5 cm - 7 1/4 "



**J243721**  
19 cm - 7 1/2 "

### ABOULKER

RIZZUTI



Fine légèrement courbe  
Fine slightly curved

Fine 1/2 courbe  
Fine 1/2 curved

Fine très courbe  
Fine very curved

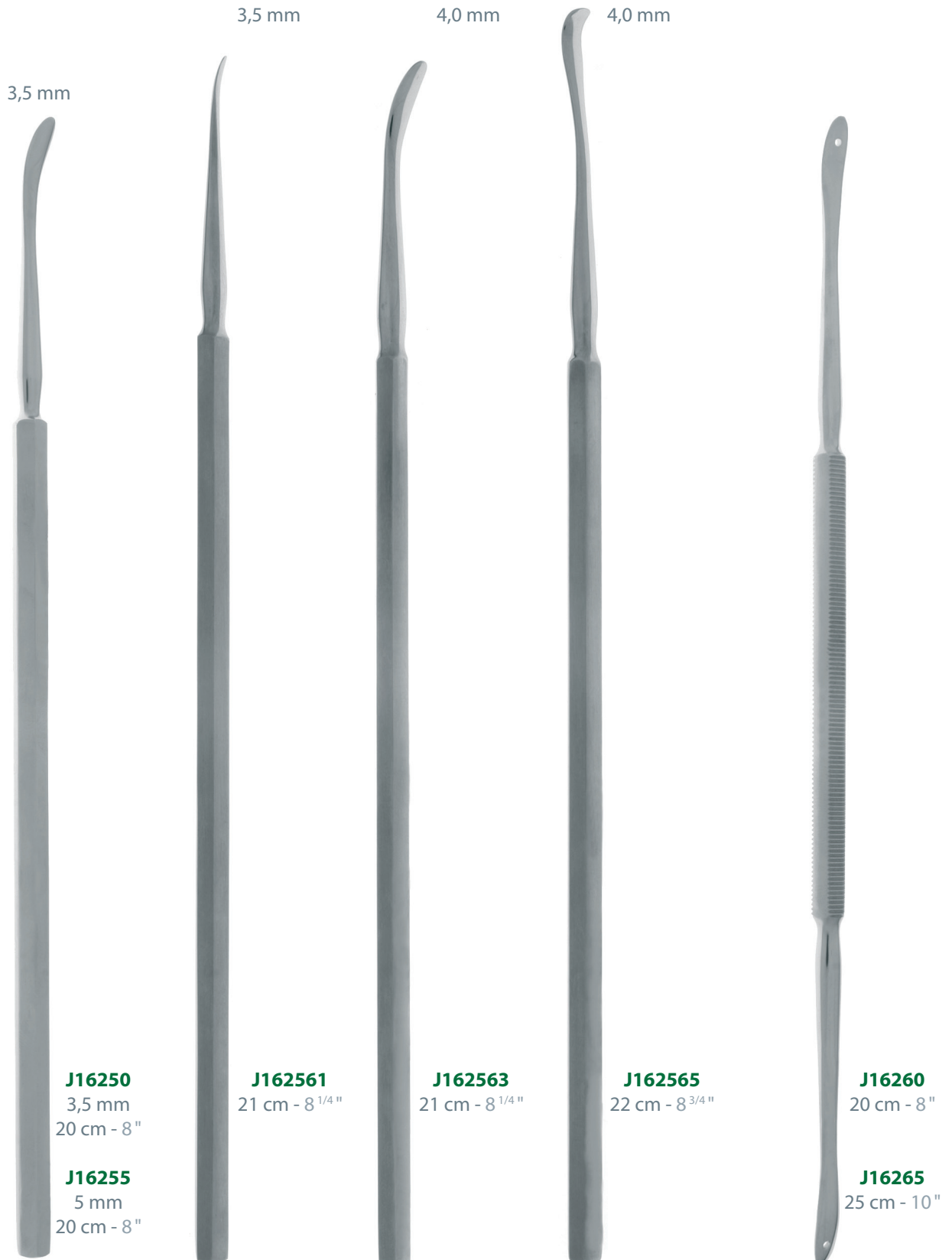





### ROBB

### CARPENTER

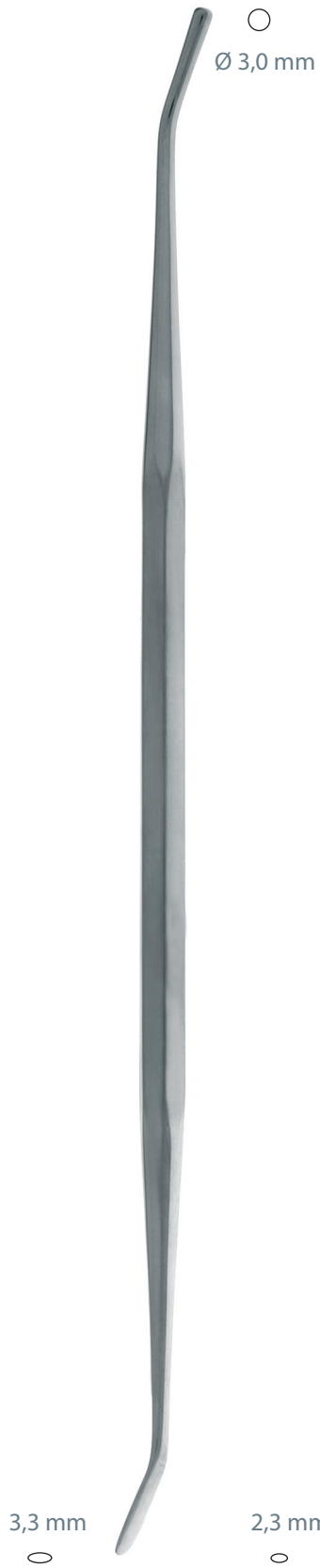

**J16270**  
22 cm - 8 <sup>3</sup>/<sub>4</sub> "

**J162702**  
19 cm - 7 <sup>1</sup>/<sub>2</sub> "

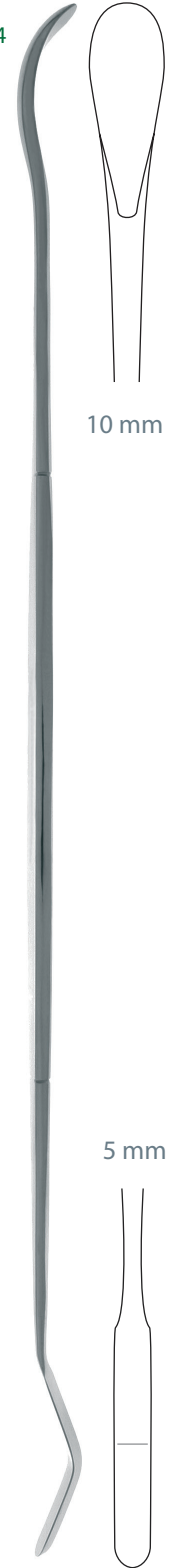

**J16275**  
26 cm - 10 <sup>1</sup>/<sub>4</sub> "

### KÖNIG

### HALLE



**J243735**  
15,5 cm - 6 "



**J243735**  
4,5 mm



**J243736**  
4,5 mm

4 mm



**J243738**  
19,5 cm - 7 <sup>3</sup>/<sub>4</sub> "

### KRAMER

10 mm



**J244900**  
18,5 cm - 7 1/4 "

### SEDILLOT

18 mm

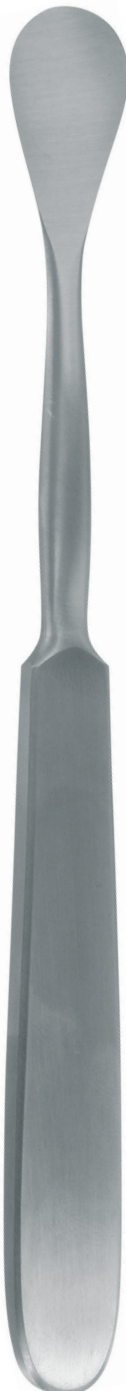

**J245000**  
18,5 cm - 7 1/4 "

### COTTLE

8 mm



**J245020**  
19,5 cm - 7 3/4 "



### JANSEN

### KRAMER

### KEY



15 mm



**J245110**  
16,5 cm - 6 1/4 "

10 mm



**J245120**  
19 cm - 7 1/2 "

6 mm



**J245130**  
18 cm - 7"

PENNYBACKER

LANGENBECK



6 mm



**J245140**  
16,5 cm - 6 1/4 "

16 mm



**J245150**  
19 cm - 7 1/2 "

### MUHLING

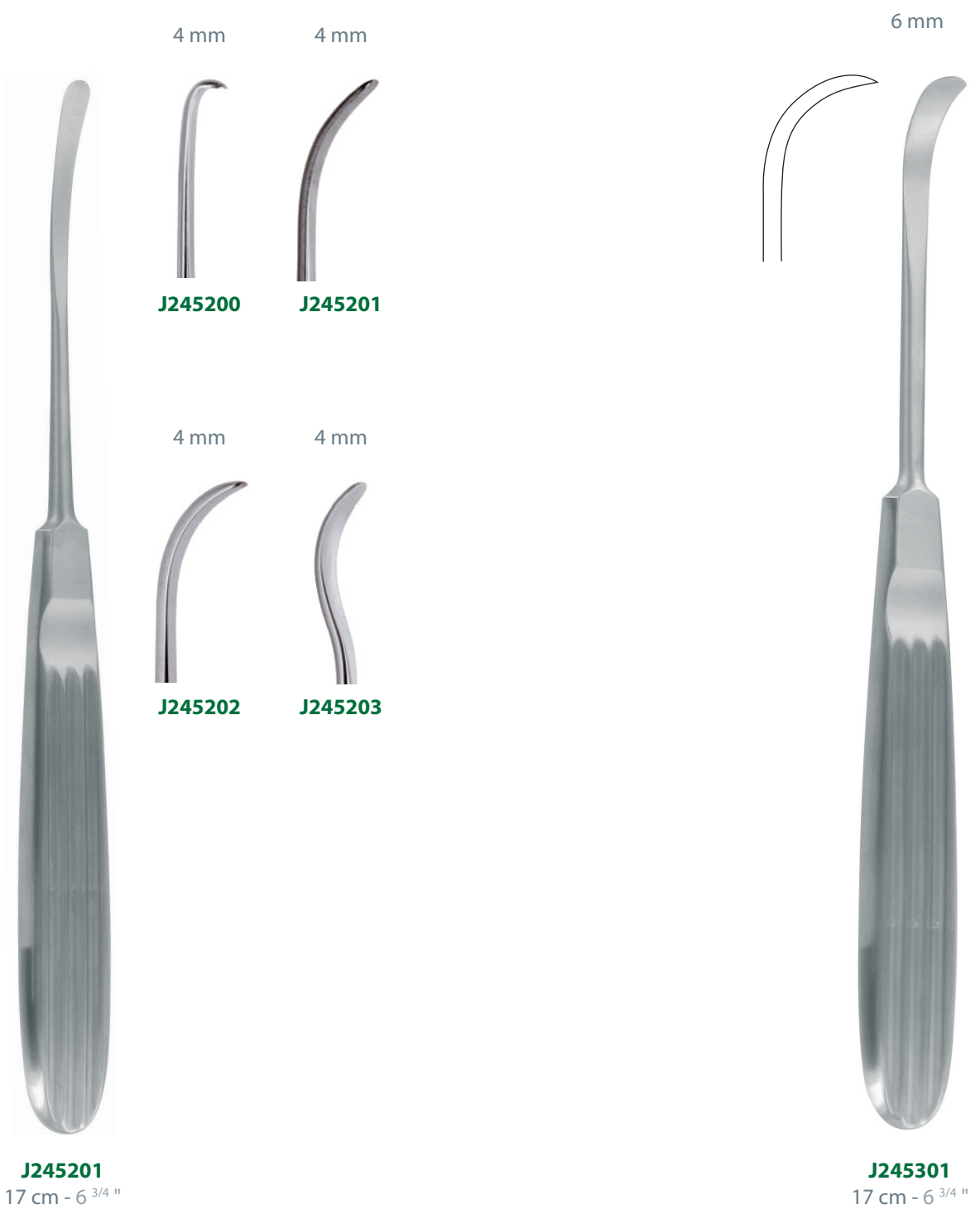

CASPAR



6,2 mm



**J245302**  
18 cm - 7 "

8 mm



**J245304**  
17 cm - 6 <sup>3</sup>/<sub>4</sub> "

6 mm

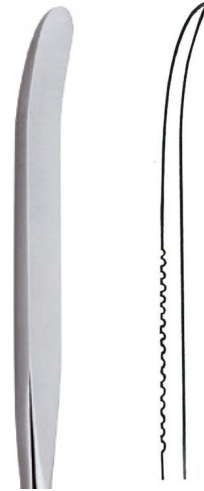

**J245303**  
17 cm - 6 <sup>3</sup>/<sub>4</sub> "

### CAIRNS (CLOVIS VINCENT)

### CREED



**J08070**  
19 cm - 7 1/2"



**J08080**  
21 cm - 8 1/4"

3,5 mm



DE MARTEL

DAVIS

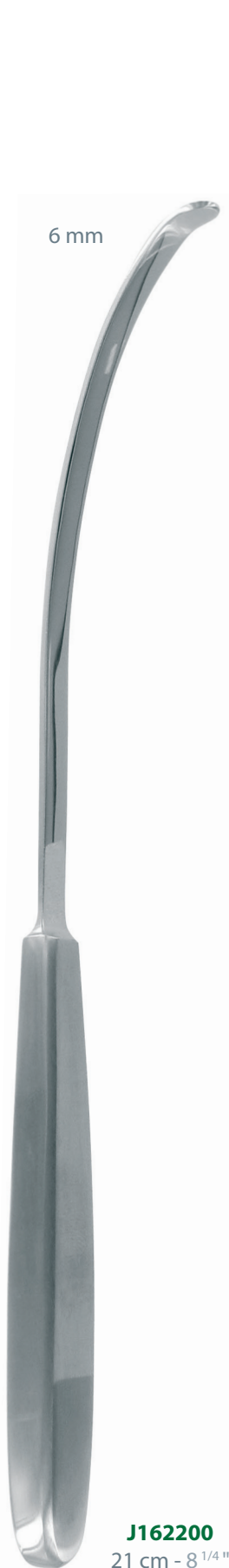

6 mm

**J162200**  
21 cm - 8 1/4"



6 mm

Mousse  
Blunt

Tranchant  
Sharp

6 mm

**J16230**  
24 cm - 9 1/2"

## Crochets - Hooks

### CRILE



### CUSHING

Mousse  
Blunt



### CASPAR



**J162801**



**J162802**



**J162803**

**J162802**  
24,5 cm - 9 5/8"

### BRUNS



#### Ronde - Round



3,3 mm



4,5 mm



5,0 mm



7,0 mm



8,5 mm



10 mm



12,5 mm



14 mm



15 mm

3,3 mm

**J283100**

4,5 mm

**J283101**

5,0 mm

**J283102**

7,0 mm

**J283103**

8,5 mm

**J283104**

10 mm

**J283105**

12,5 mm

**J283106**

14 mm

**J283107**

15 mm

**J283108**

**J283100**

17 cm - 6 <sup>3</sup>/<sub>4</sub> "

## Curettes osseuses - Bone curettes



### BRUNS

#### Ovale - Oval



3,3 mm



3,9 mm



4,7 mm



5,3 mm



6,0 mm



7,2 mm



8,2 mm



9,8 mm



12 mm

Droite  
Straight

Coudée 45°  
Angled 45°

<b>J283200</b>	3,3 mm
<b>J283201</b>	3,9 mm
<b>J283202</b>	4,7 mm
<b>J283203</b>	5,3 mm
<b>J283204</b>	6,0 mm
<b>J283205</b>	7,2 mm
<b>J283206</b>	8,2 mm
<b>J283207</b>	9,8 mm
<b>J283208</b>	12 mm

<b>J283210</b>	3,3 mm
<b>J283211</b>	3,9 mm
<b>J283212</b>	4,7 mm
<b>J283213</b>	5,3 mm
<b>J283214</b>	6,0 mm
<b>J283215</b>	7,2 mm
<b>J283216</b>	8,2 mm
<b>J283217</b>	9,8 mm
<b>J283218</b>	12 mm

**J283204**  
23 cm - 9 "

**J283214**  
23 cm - 9 "



HALLE

DAUBENSPECK

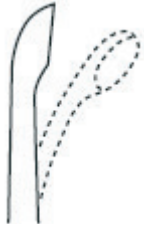

Malléable  
Malleable



**J283790**  
4,8 mm



**J283791**  
5,8 mm



**J283792**  
6,8 mm

**J283791**  
21 cm - 8 1/4 "



**J283800**  
2,8 mm



**J283801**  
3,6 mm



**J283802**  
4,4 mm



**J283803**  
5,2 mm

**J283801**  
20 cm - 8 "

### LEMPERT



**J283812**  
21 cm - 8 "



○  
**J283810**  
1,7 mm



○  
**J283811**  
2 mm



○  
**J283812**  
2,4 mm



○  
**J283813**  
2,7 mm



○  
**J283814**  
3 mm



**J283821**  
25 cm - 10 "



○  
**J283820**  
3,6 mm



○  
**J283821**  
4,4 mm



○  
**J283822**  
5,2 mm



○  
**J283823**  
6,0 mm



○  
**J283830**  
3,6 mm



○  
**J283831**  
4,4 mm



○  
**J283832**  
5,2 mm





○  
**J283833**  
6,0 mm

### CASPAR



  
**J283850**  
3,6 mm

  
**J283851**  
4,4 mm

  
**J283852**  
5,2 mm

**J283851**  
22 cm - 8 3/4"



  
**J283860**  
3,6 mm

  
**J283861**  
4,4 mm

  
**J283862**  
5,2 mm

**J283861**  
22 cm - 8 3/4"



  
**J283840**  
3 mm

  
**J283841**  
4 mm

  
**J283842**  
5 mm

**J283841**  
22 cm - 8 3/4"

## Curettes osseuses - Bone curettes

### MARTINI

### WILLIGER



Ronde  
Round

Ovale  
Oval



Ø 4,2 mm



2,5 mm

Ø 3,1 mm

3,0 mm

**J284280**  
14 cm - 5 1/2 "

**J284274**  
13,5 cm - 5 1/4 "



### HAJEK

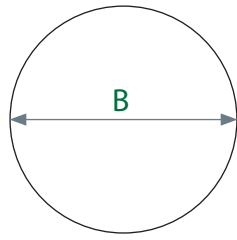

Poids  
Weight

140 g - 0,31 lbs

A

44 mm

B

27 mm

**J401600**

**J401600**

21,5 cm - 8 "

## Maillets - Mallets



Aluminium  
Aluminum

COTTLE



	Poids Weight	A	B
<b>J401400</b>	135 g - 0,40 lbs	55 mm	25 mm
<b>J401405</b>	240 g - 0,77 lbs	50 mm	30 mm

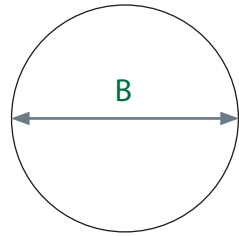

Paire de disques interchangeable  
Pair of spare disks

**J401401**

**J401400**  
19 cm - 7 1/2 "

**J401405**  
19 cm - 7 1/2 "

### CLOVIS VINCENT



**J150140**  
20 cm - 8"

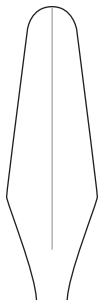

**A J150100**  
18 cm - 7"



**B J150110**  
19 cm - 7 1/2"

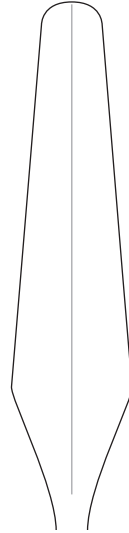

**C J150120**  
21 cm - 8 1/4"



**D J150130**  
21 cm - 8 1/4"

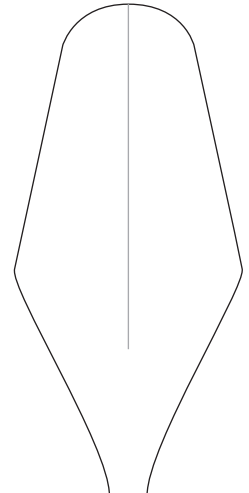

**F J150140**  
20 cm - 8"

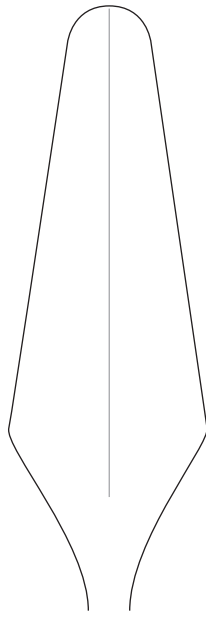

**G J150150**  
22 cm - 8 3/4"

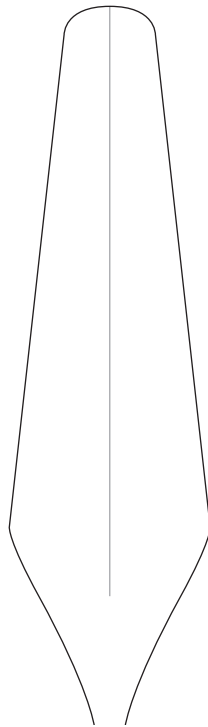

**I J150160**  
23,5 cm - 9 1/4"

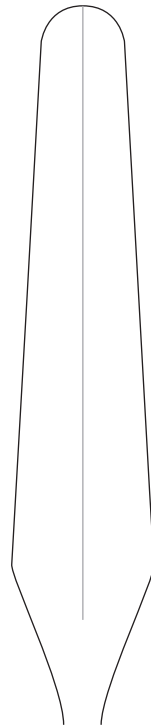

**J J150170**  
23,5 cm - 9 1/4"



**K J150180**  
23,5 cm - 9 1/4"

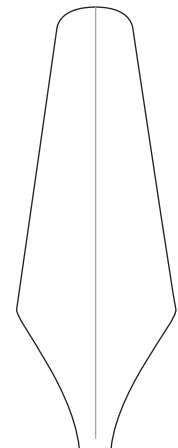

**L J150190**  
20 cm - 8"

# LANDANGER

## Spatules - Spatulas

### CUSHING

- 17 cm - 6 1/2" **J151001**
- 20 cm - 7 3/4" **J151002**

### OLIVECRONA

- 7 x 9 mm **J151010**
- 11 x 13 mm **J151011**
- 15 x 18 mm **J151012**
- 18 x 22 mm **J151013**

### Lame malléable - Malleable spatula



- 12 mm **J151030**
- 17 mm **J151031**



**J151002**  
20 cm - 8"

Concave  
Concave

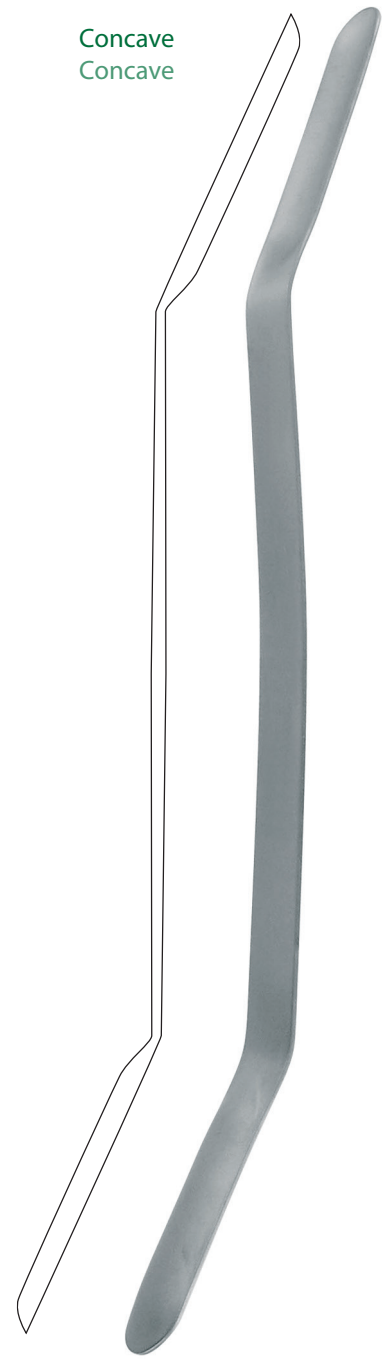

**J151010**  
18 cm - 7"

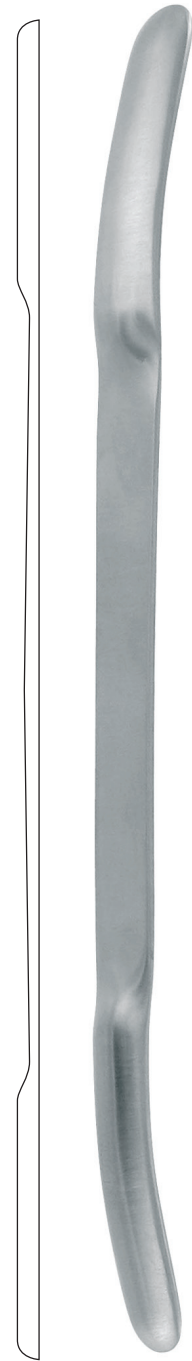

**J151021**  
18 cm - 7"



**J151031**  
20 cm - 8"

## Spatules - Spatulas

### HEIFETZ

7 x 8 mm	<b>J151040</b>
10 x 11 mm	<b>J151041</b>
13 x 14 mm	<b>J151042</b>
16 x 17 mm	<b>J151043</b>
19 x 20 mm	<b>J151044</b>
22 x 25 mm	<b>J151045</b>

8 mm	<b>J151050</b>
11 mm	<b>J151051</b>
14 mm	<b>J151052</b>
17 mm	<b>J151053</b>

### AACHEN

7 x 8 mm	<b>J151060</b>
10 x 11 mm	<b>J151061</b>



Lame malléable  
Malleable spatula

10 cm



**J151041**  
20 cm - 8"



**J151051**  
15,5 cm - 6"



**J151061**  
20 cm - 8"

## Écarteurs à nerf - Nerve retractors

### LOVE



**J152001**  
7 mm  
19,5 cm - 8"



**J152002**  
7 mm  
19,5 cm - 8"



**J152003**  
7 mm  
19,5 cm - 8"

LOVE



4 mm

**J152000**  
21 cm - 8 1/4 "

CASPAR

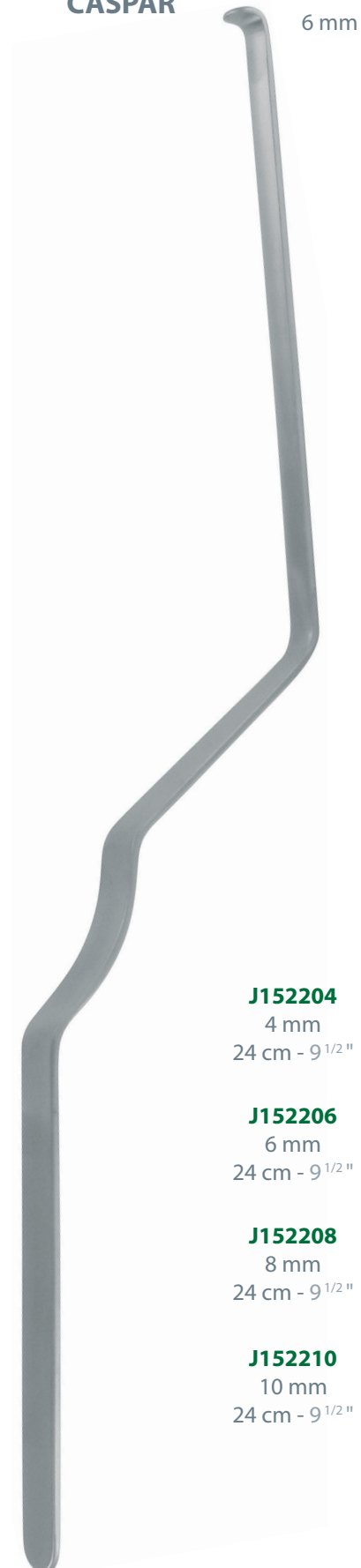

6 mm



**J152204**  
4 mm  
24 cm - 9 1/2 "

**J152206**  
6 mm  
24 cm - 9 1/2 "

**J152208**  
8 mm  
24 cm - 9 1/2 "

**J152210**  
10 mm  
24 cm - 9 1/2 "

**J152206**  
24 cm - 9 1/2 "

### HESS

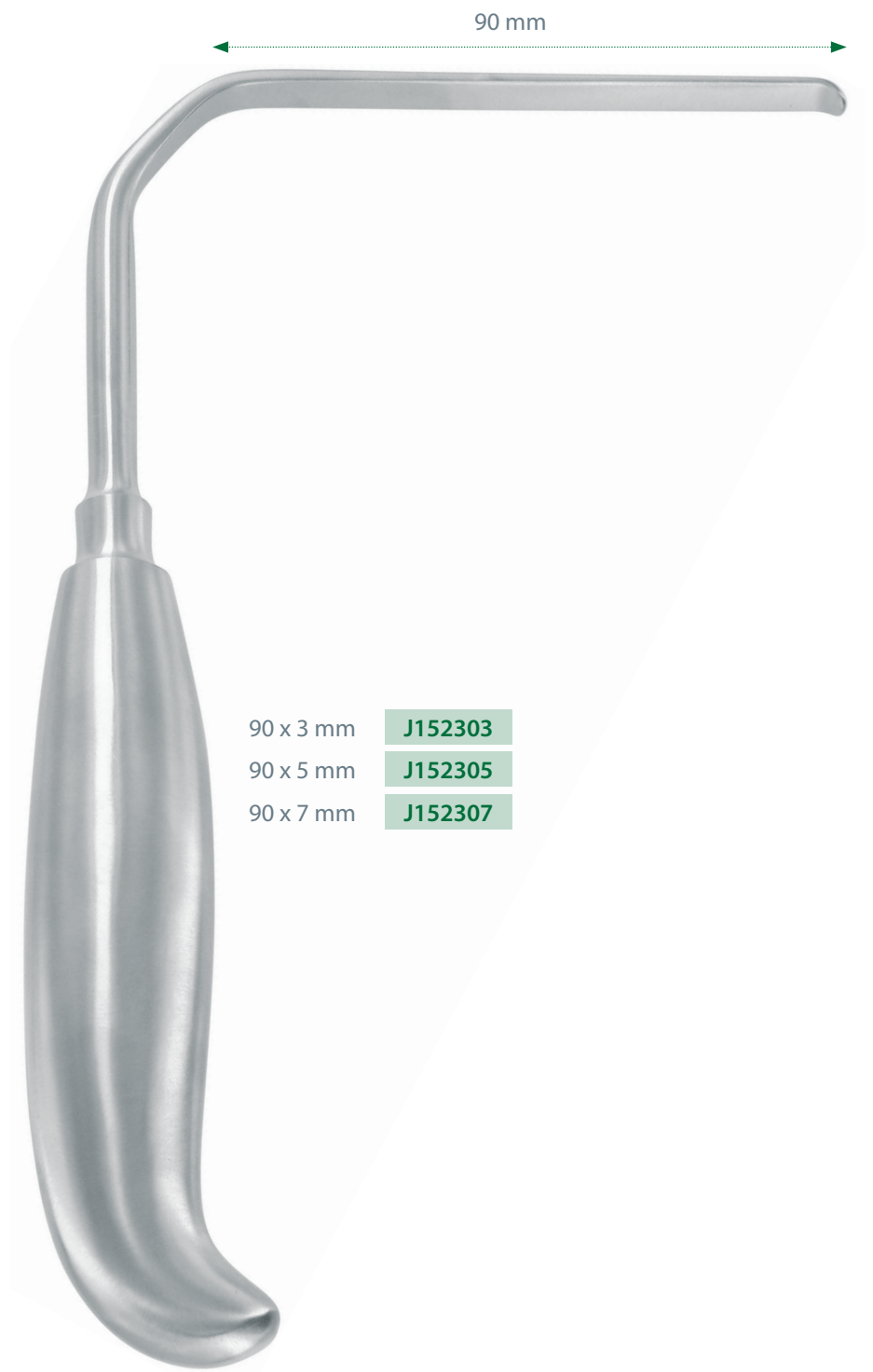

- 90 x 3 mm **J152303**
- 90 x 5 mm **J152305**
- 90 x 7 mm **J152307**

**J152305**  
18,5 cm - 7<sup>1/4</sup>"



HOLSHER



Courbe  
Curved

- 7 mm **J152100**
- 9 mm **J152101**

**J152100**  
24 cm - 9 1/2 "

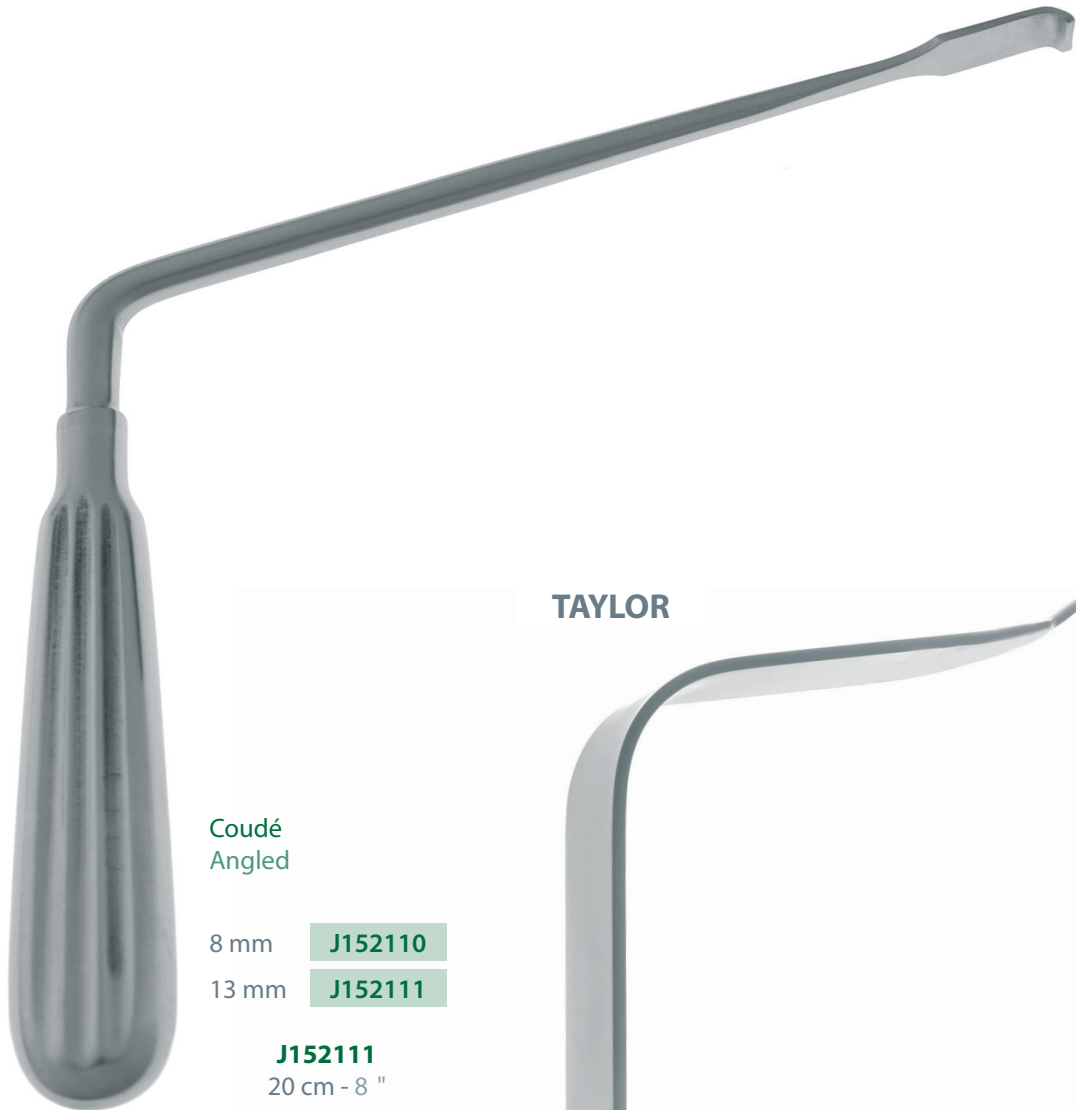

Coudé  
Angled

- 8 mm **J152110**
- 13 mm **J152111**

**J152111**  
20 cm - 8 "

TAYLOR

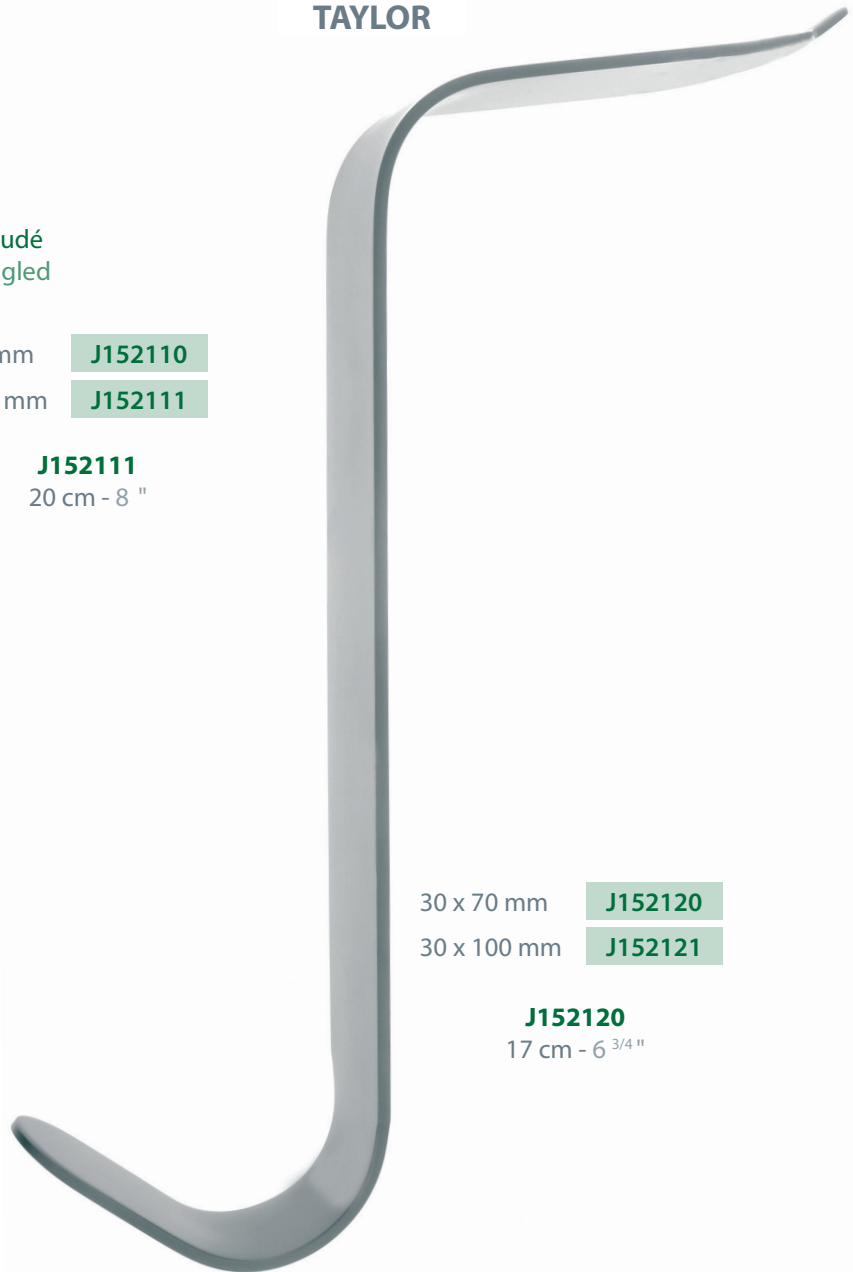

- 30 x 70 mm **J152120**
- 30 x 100 mm **J152121**

**J152120**  
17 cm - 6 3/4 "



## Micro pinces à dissection - Micro dissecting forceps

## Pinces dissection - Dissecting forceps

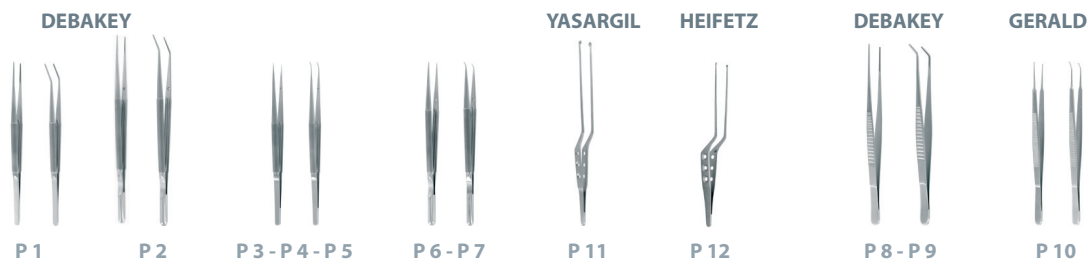

II - Micro-instruments  
II - Micro-instruments

## Micro ciseaux - Micro scissors

## Micro ciseaux baïonnette - Bayonet micro scissors

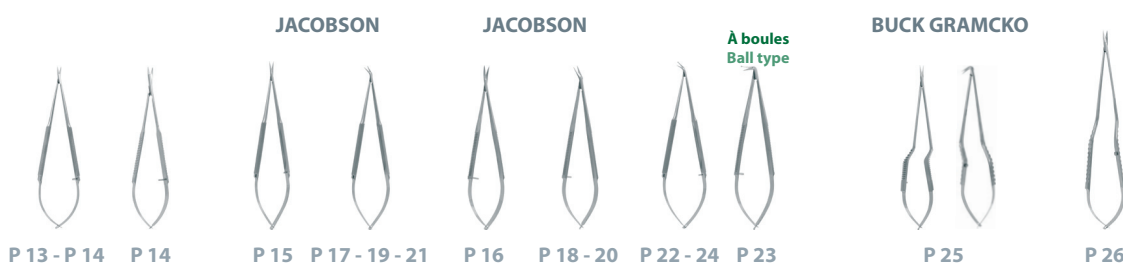

## Pousse noeuds Knot pusher

## Micro porte-aiguilles - Micro needle holders



## HEAVY STYLE JACOBSON JACOBSON JACOBSON CASTROVIEJO

## Porte-aiguilles - Needle holders



## Crochets - Hooks

## Micro crochets - Micro hooks

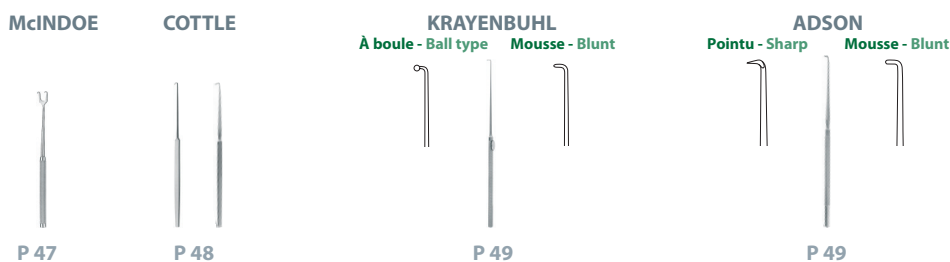

## Pousse noeuds - Knot pusher

CASPAR



P 50

## Dissecteurs - Dissectors

TÖNNIS



P 50

NATALI



P 50

## Sondes - Probes

JACOBSON

À boules  
Ball type

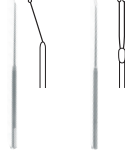

P 52

## Micro rugines - Micro raspatories

YASARGIL

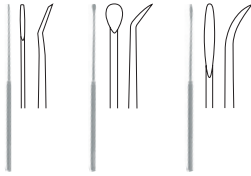

P 53

## Micro dissecteurs - Micro dissectors

CASPAR

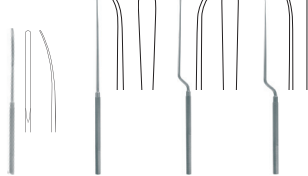

P 51

P 51 - 52

YASARGIL



P 53

## Micro crochets - Micro hooks

FISH



P 54

## Micro-couteaux - Micro knife

SAMII

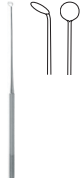

P 54

JACOBSON



P 54

KOOS



P 55

YASARGIL



P 55

### DEBAKEY



Manche rond - Mors 1,3 mm - Round Handle - Jaws 1,3 mm



Droite, Manche Ø 8 mm  
Pression 180 g  
Straight, Ø 8 mm Handle  
Pressure 180 gr



**DC12000-12**

120 mm - 4 3/4 "

**DC12000-15**

150 mm - 6 "

**DC12000-18**

180 mm - 7 "

**DC12000-21**

210 mm - 8 "

**DC12000-23**

230 mm - 9 "

Droite, Manche Ø 10 mm  
Pression 250 gr  
Straight, Ø 10 mm Handle  
Pressure 250 gr

**DC12010-18**

180 mm - 7 "

**DC12010-21**

210 mm - 8 "

**DC12000-18**  
180 mm - 7 "



Coudée, Manche Ø 8 mm  
Pression 180 g  
Angled, Ø 8 mm Handle  
Pressure 180 gr



**DC12001-12**

120 mm - 4 3/4 "

**DC12001-15**

150 mm - 6 "

**DC12001-18**

180 mm - 7 "

**DC12001-21**

210 mm - 8 "

**DC12001-23**

230 mm - 9 "

**DC12001-18**  
180 mm - 7 "

### DEBAKEY



Manche rond - Mors 1,3 mm - Contrebalancée - Round Handle - Jaws 1,3 mm - Counterbalanced

II - Micro-instruments  
II - Micro-instruments



Droite, Manche Ø 8 mm  
Pression 180 g  
Straight, Ø 8 mm Handle  
Pressure 180 gr



**DC12500-18**  
180 mm - 7 "  
**DC12500-21**  
210 mm - 8 "

**DC12500-21**  
210 mm - 8 "



Coudée, Manche Ø 8 mm  
Pression 180 g  
Angled, Ø 8 mm Handle  
Pressure 180 gr



**DC12501-18**  
180 mm - 7 "  
**DC12501-21**  
210 mm - 8 "

**DC12501-21**  
210 mm - 8 "

Manche rond - Sans plateforme - Round Handle - Without platform



Droite, Manche Ø 8 mm  
Pression 180 g  
Straight, Ø 8 mm Handle  
Pressure 180 gr

0,4 mm



**DC12100-12**

120 mm - 4 3/4 "

**DC12100-15**

150 mm - 6 "

**DC12100-18**

180 mm - 7 "

**DC12100-21**

210 mm - 8 "

**DC12100-18**  
180 mm - 7 "



Courbe, Manche Ø 8 mm  
Pression 180 g  
Curved, Ø 8 mm Handle  
Pressure 180 gr

0,4 mm



**DC12101-12**

120 mm - 4 3/4 "

**DC12101-15**

150 mm - 6 "

**DC12101-18**

180 mm - 7 "

**DC12101-21**

210 mm - 8 "

**DC12101-18**  
180 mm - 7 "

### Manche rond - Avec plateforme - Round Handle - With platform



Droite, Manche Ø 8 mm  
Pression 180 g  
Straight, Ø 8 mm Handle  
Pressure 180 gr

0,4 x 6 mm



**DC12310-12**  
120 mm - 4 <sup>3/4</sup> "

**DC12310-15**   
150 mm - 6 "

**DC12310-18**   
180 mm - 7 "

**DC12310-21**   
210 mm - 8 "

0,8 x 6 mm



**DC12320-15**  
150 mm - 6 "

**DC12320-18**  
180 mm - 7 "

**DC12320-21**  
210 mm - 8 "

Droite, Manche Ø 10 mm  
Pression 250 g  
Straight, Ø 10 mm Handle  
Pressure 250 gr

0,4 x 6 mm



**DC12330-18**   
180 mm - 7 "

**DC12330-21**   
210 mm - 8 "

0,8 x 6 mm



**DC12340-18**   
180 mm - 7 "

**DC12340-21**   
210 mm - 8 "

Courbe, Manche Ø 8 mm  
Pression 180 g  
Curved, Ø 8 mm Handle  
Pressure 180 gr

0,4 x 6 mm



**DC12311-12**  
120 mm - 4 <sup>3/4</sup> "

**DC12311-15**   
150 mm - 6 "

**DC12311-18**   
180 mm - 7 "

**DC12311-21**   
210 mm - 8 "

0,8 x 6 mm



**DC12321-15**  
150 mm - 6 "

**DC12321-18**  
180 mm - 7 "

**DC12321-21**  
210 mm - 8 "

**DC12310-18**  
180 mm - 7 "

**DC12311-18**  
180 mm - 7 "



Manche rond - À griffes avec plateforme - Round Handle - With platform and teeth



Droit, Manche Ø 8 mm  
Griffes : 1 x 2  
Pression 180 g  
Straight, Ø 8 mm Handle  
Teeth : 1 x 2  
Pressure 180 gr

0,5 x 6 mm



**DC12410-12**  
120 mm - 4 <sup>3</sup>/<sub>4</sub> "

**DC12410-15**   
150 mm - 6 "

**DC12410-18**   
180 mm - 7 "

**DC12410-21**   
205 mm - 8 "



**DC12410-18**  
180 mm - 7 "

Courbe, Manche Ø 8 mm  
Griffes : 1 x 2  
Pression 180 g  
Curved, Ø 8 mm Handle  
Teeth : 1 x 2  
Pressure 180 gr

0,5 x 6 mm



**DC12411-12**  
120 mm - 4 <sup>3</sup>/<sub>4</sub> "

**DC12411-15**   
150 mm - 6 "

**DC12411-18**   
180 mm - 7 "

**DC12411-21**   
205 mm - 8 "



Manche rond - Contrebalancée - Round Handle - Counterbalanced

Droite, Manche Ø 8 mm  
Sans plateforme  
Pression 180 g  
Straight, Ø 8 mm Handle  
Without platform  
Pressure 180 gr

0,4 mm



**DC12600-15**

150 mm - 6 "

**DC12600-18**

180 mm - 7 "

**DC12600-21**

205 mm - 8 "

Avec plateforme  
Pression 180 g

With platform  
Pressure 180 gr

0,4 x 6 mm



**DC12710-15**

150 mm - 6 "

**DC12710-18**

180 mm - 7 "

**DC12710-21**

205 mm - 8 "

Griffes : 1 x 2  
Avec plateforme  
Pression 180 g

Teeth : 1 x 2  
With platform  
Pressure 180 gr

0,5 x 6 mm



**DC12810-15**

150 mm - 6 "

**DC12810-18**

180 mm - 7 "

**DC12810-21**

205 mm - 8 "

Courbe, Manche Ø 8 mm  
Sans plateforme  
Pression 180 g  
Curved, Ø 8 mm Handle  
Without platform  
Pressure 180 gr

0,4 mm



**DC12601-15**

150 mm - 6 "

**DC12601-18**

180 mm - 7 "

**DC12601-21**

205 mm - 8 "



**DC12710-18**  
180 mm - 7 "



**DC12601-18**  
L : 180 mm - 7 "

Manche rond - Extrémité anneau - Round Handle - Ring Tip



Diamorite

Manche Ø 8 mm  
Pression 180 g  
Ø 8 mm Handle  
Pressure 180 gr

Ø 1 mm



**DC12900-12**

120 mm - 4 <sup>3</sup>/<sub>4</sub> "

**DC12900-15**

150 mm - 6 "

**DC12900-18**

180 mm - 7 "

**DC12900-21**

210 mm - 8 "



Ø 2 mm



**DC12905-12**

120 mm - 4 <sup>3</sup>/<sub>4</sub> "

**DC12905-15**

150 mm - 6 "

**DC12905-18**

180 mm - 7 "

**DC12905-21**

210 mm - 8 "



Counterbalanced

Manche Ø 8 mm  
Pression 180 g  
Ø 8 mm Handle  
Pressure 180 gr

Ø 1 mm



**DC12920-15**

150 mm - 6 "

**DC12920-18**

180 mm - 7 "

**DC12920-21**

210 mm - 8 "

Ø 2 mm



**DC12925-15**

150 mm - 6 "

**DC12925-18**

180 mm - 7 "

**DC12925-21**

210 mm - 8 "



**DC12905-18**

180 mm - 7 "



**DC12925-18**

180 mm - 7 "

### DEBAKEY



II - Micro-instruments  
II - Micro-instruments



Droite - Pression 200 g - Straight - Pressure 200 gr

1 mm



**DC13101-12**

120 mm - 4 <sup>3</sup>/<sub>4</sub> "

**DC13101-16**

160 mm - 6 "

**DC13101-20**

200 mm - 8 "

**DC13101-24**

240 mm - 9 <sup>1</sup>/<sub>2</sub> "

**DC13101-30**

300 mm - 12 "

1,5 mm



**DC13100-16**

160 mm - 6 "



**DC13100-20**

200 mm - 8 "



**DC13100-24**

240 mm - 9 <sup>1</sup>/<sub>2</sub> "



**DC13100-30**

300 mm - 12 "

2,0 mm



**DC13200-16**

160 mm - 6 "



**DC13200-20**

200 mm - 8 "



**DC13200-24**

240 mm - 9 <sup>1</sup>/<sub>2</sub> "



**DC13200-30**

300 mm - 12 "

2,8 mm



**DC13300-16**

160 mm - 6 "



**DC13300-20**

200 mm - 8 "



**DC13300-24**

240 mm - 9 <sup>1</sup>/<sub>2</sub> "



**DC13300-30**

300 mm - 12 "

3,5 mm



**DC13400-16**

160 mm - 6 "

**DC13400-20**

200 mm - 8 "

**DC13400-24**

240 mm - 9 <sup>1</sup>/<sub>2</sub> "

**DC13400-30**

300 mm - 12 "

**DC13100-20**

200 mm - 8 "



### DEBAKEY



Coudée - Pression 200 g - Angled - Pressure 200 gr



2,0 mm



**DC13500-16**

160 mm - 6 "



**DC13500-20**

200 mm - 8 "



**DC13500-24**

240 mm - 9<sup>1/2</sup> "



**DC13500-30**

300 mm - 12 "

**DC13500-20**

200 mm - 8 "

### GERALD



Droite - Extrémité anneau  
Straight - Ring Tip

Ø 1 mm



**DC14000-14**  
140 mm - 5 1/2 "

**DC14000-18**  
180 mm - 7 "

Avec plateforme  
With platform

1 mm



**DC14110-14**  
140 mm - 5 1/2 "

**DC14110-18**  
180 mm - 7 "

Courbe - Extrémité anneau  
Curved - Ring Tip

Ø 1 mm



**DC14001-14**  
140 mm - 5 1/2 "

**DC14001-18**  
180 mm - 7 "

Avec plateforme - Griffes : 1 x 2  
With platform - Teeth : 1 x 2

1 mm



**DC14100-14**  
140 mm - 5 1/2 "

**DC14100-18**  
180 mm - 7 "

1 mm



**DC14210-14**  
140 mm - 5 1/2 "

**DC14210-18**  
180 mm - 7 "

Avec plateforme - Griffes : 1 x 2  
With platform - Teeth : 1 x 2

1 mm



**DC14211-14**  
140 mm - 5 1/2 "

**DC14211-18**  
180 mm - 7 "



**DC14000-18**  
180 mm - 7 "



**DC14001-18**  
180 mm - 7 "

YASARGIL



Mors cuillère  
Jaw spoon-shaped

⊙  
Ø: 3 mm  
**DC12305-22**  
220 mm - 8 3/4"

⊙  
Ø: 5 mm  
**DC12304-22**  
220 mm - 8 3/4"

⊙  
Ø: 3 mm  
**DC12305-24**  
240 mm - 9 1/2"

⊙  
Ø: 5 mm  
**DC12304-24**  
240 mm - 9 1/2"

⊙  
Ø: 7 mm  
**DC12306-24**  
240 mm - 9 1/2"

**DC12304-24**  
240 mm - 9 1/2"

HEIFETZ



II - Micro-instruments  
II - Micro-instruments



Mors curette dentelés  
Curette toothed jaws

⊙  
Ø : 3 mm  
**DC12302-22**  
220 mm - 8 3/4 "

⊙  
Ø : 5 mm  
**DC12303-22**  
220 mm - 8 3/4 "

**DC12302-22**  
220 mm - 8 3/4 "



Lames 10 mm - 10 mm blades



**DC20110-18**  
180 mm - 7 "

Droit  
Straight



**DC20110-12**  
120 mm - 4 <sup>3</sup>/<sub>4</sub> "

**DC20110-18**  
180 mm - 7 "

Courbe  
Curved



**DC20111-12**  
120 mm - 4 <sup>3</sup>/<sub>4</sub> "

**DC20111-18**  
180 mm - 7 "



**DC20113-18**  
180 mm - 7 "

Ténotomie (Vannas)  
Tenotomy (Vannas)  
Droit  
Straight



**DC20112-09**  
90 mm - 3 <sup>1</sup>/<sub>2</sub> "

**DC20112-12**  
120 mm - 4 <sup>3</sup>/<sub>4</sub> "

**DC20112-18**  
180 mm - 7 "

Ténotomie (Vannas)  
Tenotomy (Vannas)  
Courbe  
Curved



**DC20113-09**  
90 mm - 3 <sup>1</sup>/<sub>2</sub> "

**DC20113-12**  
120 mm - 4 <sup>3</sup>/<sub>4</sub> "

**DC20113-18**  
180 mm - 7 "

Lames 10 mm - Streamline - 10 mm blades - Streamline



Streamline Design



**DC20150-18**  
180 mm - 7 "

Manche plat  
Flat Handle

Droit  
Straight



**DC20150-18**  
180 mm - 7 "

Courbe  
Curved



**DC20151-18**  
180 mm - 7 "

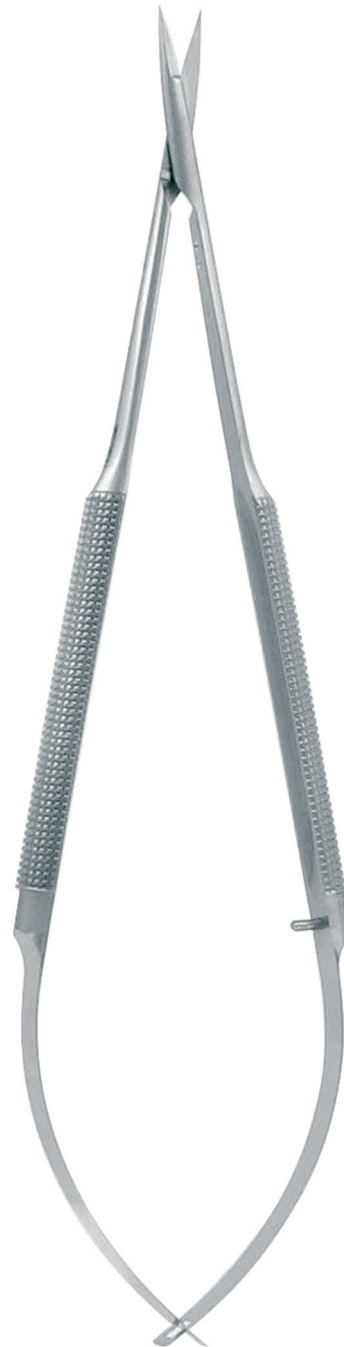

**DC20140-18**  
180 mm - 7 "

Manche rond  
Round Handle

Droit  
Straight



**DC20140-18**  
180 mm - 7 "

Courbe  
Curved



**DC20141-18**  
180 mm - 7 "

JACOBSON



Lames 14 mm - 14 mm blades

Droit  
Straight

Pointu  
Sharp



**DC20010-18**  
180 mm - 7 "



Courbe  
Curved

Pointu  
Sharp



**DC20011-18**  
180 mm - 7 "



Mousse  
Blunt



**DC20114-18**  
180 mm - 7 "



**DC20010-18**  
180 mm - 7 "

JACOBSON



Lames 14 mm - 14 mm blades

II - Micro-instruments  
II - Micro-instruments

Droit  
Straight



**DC20000-18**  
180 mm - 7 "

Courbe  
Curved



**DC20001-18**  
180 mm - 7 "



**DC20001-18**  
180 mm - 7 "

### JACOBSON



Lames 7 mm - Coudé - 7 mm blades - Angled

II - Micro-instruments  
II - Micro-instruments

**25°**  
**DC20055-12**  
 120 mm - 4 3/4 "  
**DC20055-18**  
 180 mm - 7 "

**45°**  
**DC20056-12**  
 120 mm - 4 3/4 "  
**DC20056-18**  
 180 mm - 7 "

**60°**  
**DC20057-12**  
 120 mm - 4 3/4 "  
**DC20057-18**  
 180 mm - 7 "

**90°**  
**DC20058-12**  
 120 mm - 4 3/4 "  
**DC20058-18**  
 180 mm - 7 "

**125°**  
 Axe  
**DC20059-12**  
 120 mm - 4 3/4 "  
**DC20059-18**  
 180 mm - 7 "

Circumflex  
 Axe  
**DC20065-12**  
 120 mm - 4 3/4 "  
**DC20065-18**  
 180 mm - 7 "

**DC20056-18**  
 180 mm - 7 "

JACOBSON



Lames 10 mm - Coudé - 10 mm blades - Angled

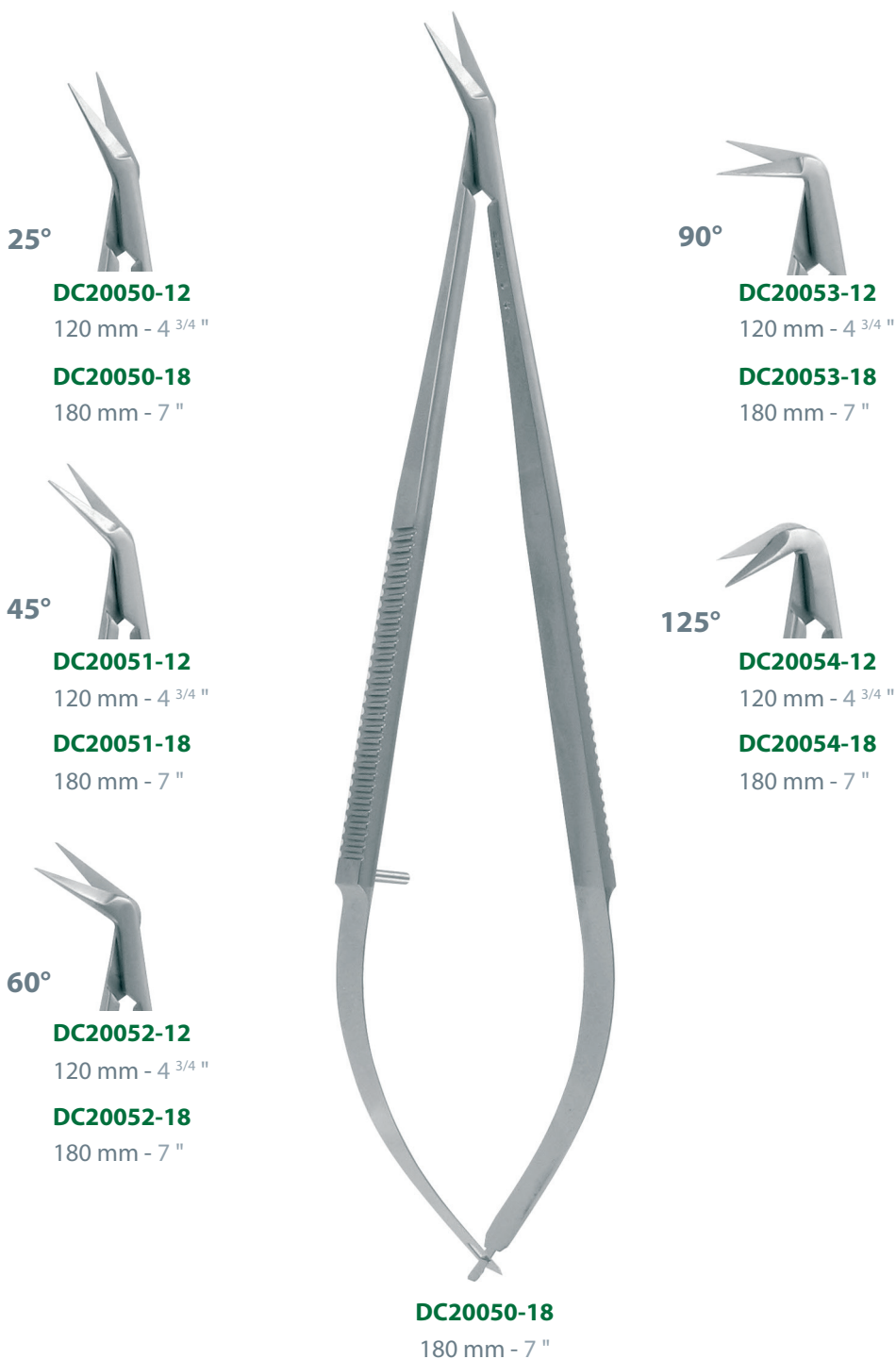

### JACOBSON



Lames 10 mm - Coudé - 10 mm blades - Angled



25°

**DC20060-12**

120 mm - 4 3/4 "

**DC20060-18**

180 mm - 7 "

**DC20060-21**

210 mm - 8 "



90°

**DC20063-12**

120 mm - 4 3/4 "

**DC20063-18**

180 mm - 7 "

**DC20063-21**

210 mm - 8 "



45°

**DC20061-12**

120 mm - 4 3/4 "

**DC20061-18**

180 mm - 7 "

**DC20061-21**

210 mm - 8 "



125°

**DC20064-12**

120 mm - 4 3/4 "

**DC20064-18**

180 mm - 7 "

**DC20064-21**

210 mm - 8 "



60°

**DC20062-12**

120 mm - 4 3/4 "

**DC20062-18**

180 mm - 7 "

**DC20062-21**

210 mm - 8 "



**DC20061-18**

180 mm - 7 "

JACOBSON



II - Micro-instruments  
II - Micro-instruments

Lames 10 mm - Coudé - Streamline - 10 mm blades - Angled - Streamline



Streamline Design

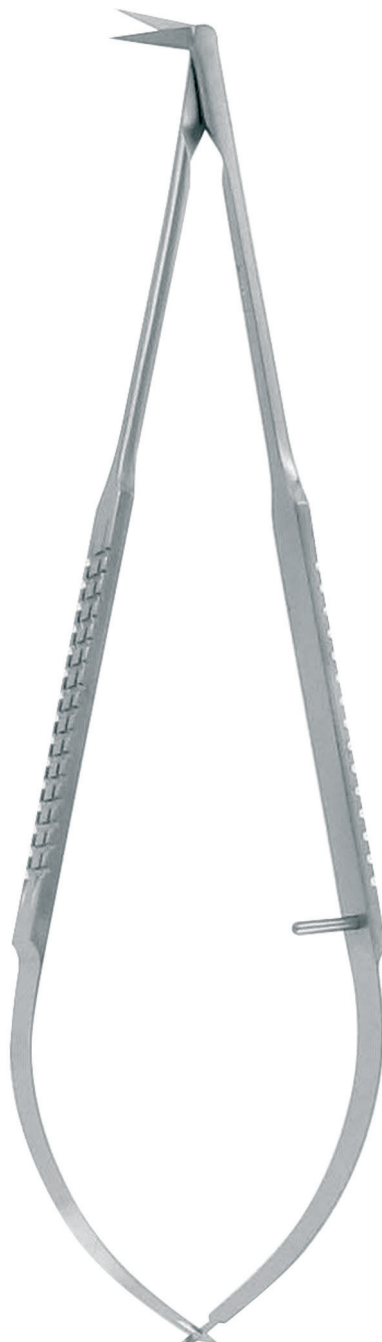

**DC20155-18**  
180 mm - 7 "

25°



**DC20152-18**  
180 mm - 7 "

45°



**DC20153-18**  
180 mm - 7 "

60°



**DC20154-18**  
180 mm - 7 "

90°



**DC20155-18**  
180 mm - 7 "

125°



**DC20156-18**  
180 mm - 7 "



JACOBSON



Lames 10 mm - Coudé - Streamline - 10 mm blades - Angled - Streamline



Streamline Design



**DC20143-18**  
180 mm - 7 "

25°



**DC20142-18**  
180 mm - 7 "

45°



**DC20143-18**  
180 mm - 7 "

60°



**DC20144-18**  
180 mm - 7 "

90°



**DC20145-18**  
180 mm - 7 "

125°



**DC20146-18**  
180 mm - 7 "

Lames 7 mm - Coudé - Boule 1 mm - 7 mm blades - Angled - Ball 1 mm

25°



**DC20160-12**  
120 mm - 4 <sup>3</sup>/<sub>4</sub> "

**DC20160-18**  
180 mm - 7 "

90°



**DC20163-12**  
120 mm - 4 <sup>3</sup>/<sub>4</sub> "

**DC20163-18**  
180 mm - 7 "

45°



**DC20161-12**  
120 mm - 4 <sup>3</sup>/<sub>4</sub> "

**DC20161-18**  
180 mm - 7 "

125°



**DC20164-12**  
120 mm - 4 <sup>3</sup>/<sub>4</sub> "

**DC20164-18**  
180 mm - 7 "

60°



**DC20162-12**  
120 mm - 4 <sup>3</sup>/<sub>4</sub> "

**DC20162-18**  
180 mm - 7 "



**DC20162-18**  
180 mm - 7 "

Lames 10 mm - Coudé - Boule 1,5 mm - 10 mm blades - Angled - Ball 1.5 mm



**DC20133-18**  
180 mm - 7 "

25°



**DC20130-18**  
180 mm - 7 "

45°



**DC20131-18**  
180 mm - 7 "

60°



**DC20132-18**  
180 mm - 7 "

90°



**DC20133-18**  
180 mm - 7 "

125°



**DC20134-18**  
180 mm - 7 "

Lames 10 mm - Coudé - Boule 1,5 mm - 10 mm blades - Angled - Ball 1.5 mm



**DC20121-18**  
180 mm - 7 "

BUCK GRAMCKO



Droit  
Straight



**DC20032-18**  
185 mm - 7 1/4 "

Courbe  
Curved



**DC20033-18**  
185 mm - 7 1/4 "



125°



**DC20040-18**  
180 mm - 7 "

**DC20032-18**  
185 mm - 7 1/4 "

**DC20040-18**  
180 mm - 7 "

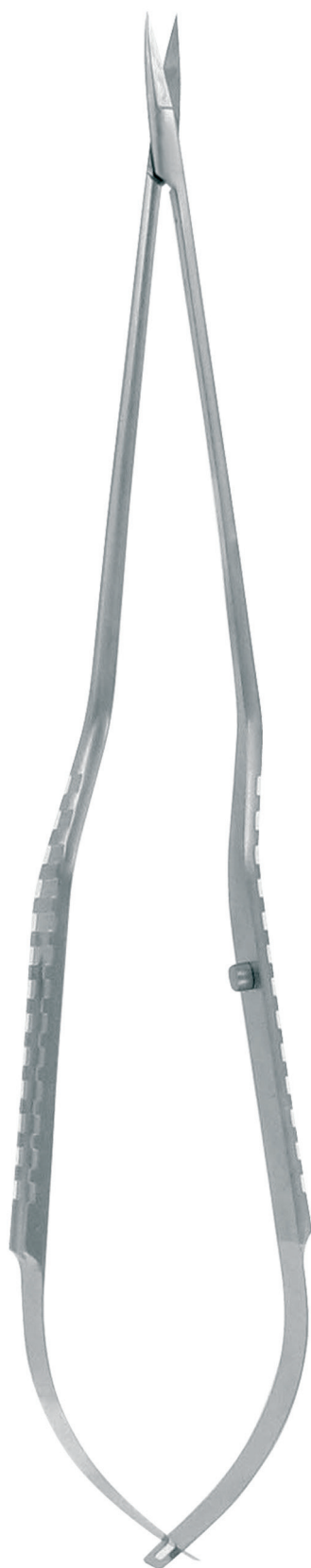

**DC20100-22**  
225 mm - 9"

Droit  
Straight



- DC20100-19**  
190 mm - 7 1/2"
- DC20100-22**   
225 mm - 9"
- DC20100-24**  
240 mm - 9 1/2"

Courbe  
Curved



- DC20101-19**  
190 mm - 7 1/2"
- DC20101-22**   
225 mm - 9"
- DC20101-24**  
240 mm - 9 1/2"



**DC20102-22**  
225 mm - 9"

Ténotomie (Vannas)  
Tenotomy (Vannas)  
Droit  
Straight



- DC20102-19**  
190 mm - 7 1/2"
- DC20102-22**   
225 mm - 9"
- DC20102-24**  
240 mm - 9 1/2"

Ténotomie (Vannas)  
Tenotomy (Vannas)  
Courbe  
Curved



- DC20103-19**  
190 mm - 7 1/2"
- DC20103-22**   
225 mm - 9"
- DC20103-24**  
240 mm - 9 1/2"



Scale : 4/1

**DC71700-24**

240 mm - 9 1/2 "

YASARGIL



Streamline Design

Largueur 0,9 mm - Streamline - Width 0.9 mm - Streamline

**For** 7/0, 8/0, 9/0, 10/0  
*Suture*



**DC51510-22**  
225 mm - 9 "

Sans verrou  
Without ratchet  
Droit  
Straight

**DC51510-20**  
200 mm - 8 "

**DC51510-22**  
225 mm - 9 "



Sans verrou  
Without ratchet  
Courbe en haut  
Upwards curved

**DC51511-20**  
200 mm - 8 "

**DC51511-22**  
225 mm - 9 "





Largeur 0,3 mm - Width 0.3 mm

**For Suture** 8/0, 9/0, 10/0, 11/0, 12/0

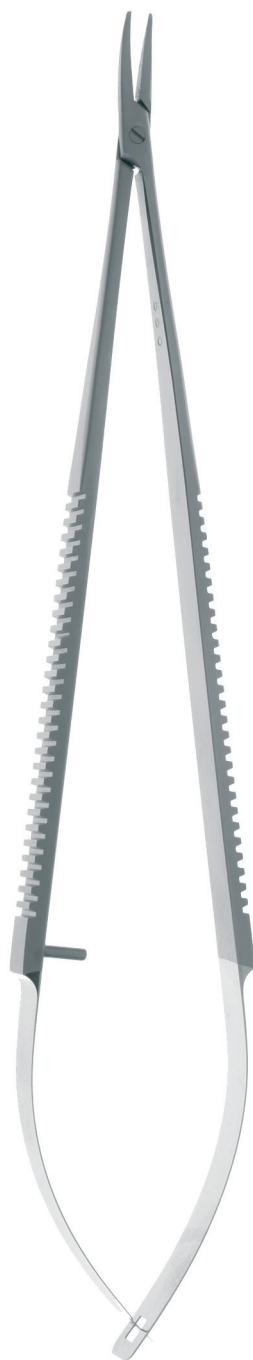

**DC50071-18**  
180 mm - 7 "

Sans verrou  
Without ratchet  
Droit  
Straight



**DC50060-14**  
145 mm - 5 <sup>3</sup>/<sub>4</sub> "

**DC50061-18**  
180 mm - 7 "

**DC50062-21**  
215 mm - 8 <sup>1</sup>/<sub>2</sub> "

Sans verrou  
Without ratchet  
Courbe  
Curved



**DC50070-14**  
145 mm - 5 <sup>3</sup>/<sub>4</sub> "

**DC50071-18**  
180 mm - 7 "

**DC50072-21**  
215 mm - 8 <sup>1</sup>/<sub>2</sub> "

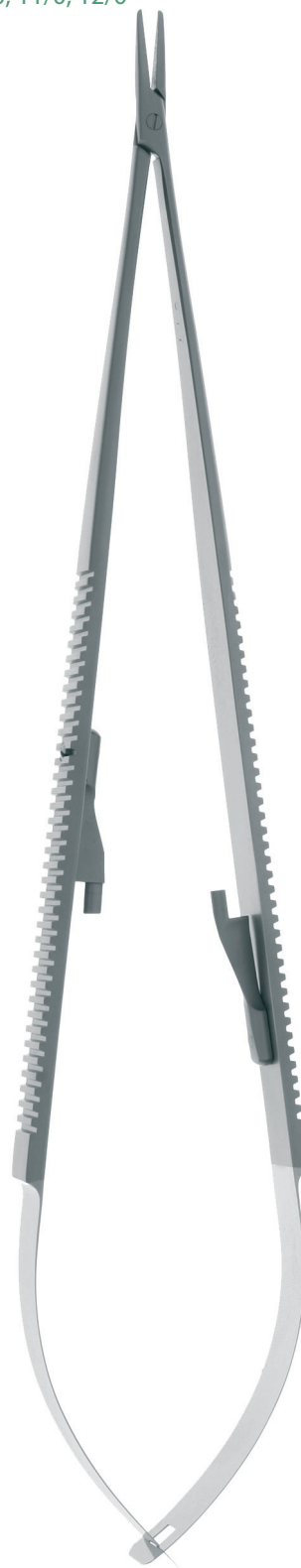

**DC50042-21**  
215 mm - 8 <sup>1</sup>/<sub>2</sub> "

Avec verrou  
With ratchet  
Droit  
Straight



**DC50040-14**  
145 mm - 5 <sup>3</sup>/<sub>4</sub> "

**DC50041-18**  
180 mm - 7 "

**DC50042-21**  
215 mm - 8 <sup>1</sup>/<sub>2</sub> "

Avec verrou  
With ratchet  
Courbe  
Curved



**DC50050-14**  
145 mm - 5 <sup>3</sup>/<sub>4</sub> "

**DC50051-18**  
180 mm - 7 "

**DC50052-21**  
215 mm - 8 <sup>1</sup>/<sub>2</sub> "



Largeur 0,3 mm - Width 0.3 mm

**For** 8/0, 9/0, 10/0, 11/0, 12/0  
*Suture*

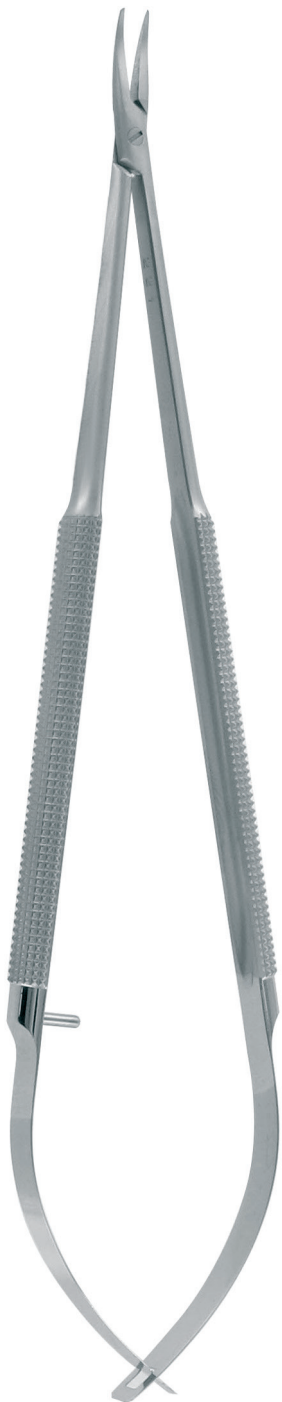

**DC50031-18**  
180 mm - 7 "

Sans verrou  
Without ratchet  
Droit  
Straight



- DC50020-12**  
120 mm - 4 <sup>3</sup>/<sub>4</sub> "
- DC50020-14**  
145 mm - 5 <sup>3</sup>/<sub>4</sub> "
- DC50021-18** 
- 180 mm - 7 "
- DC50022-21** 
- 205 mm - 8 "
- DC50023-23** 
- 225 mm - 9 "

Sans verrou  
Without ratchet  
Courbe  
Curved



- DC50030-12**  
120 mm - 4 <sup>3</sup>/<sub>4</sub> "
- DC50030-14**  
145 mm - 5 <sup>3</sup>/<sub>4</sub> "
- DC50031-18** 
- 180 mm - 7 "
- DC50032-21** 
- 205 mm - 8 "
- DC50033-23** 
- 225 mm - 9 "



**DC50002-21**  
205 mm - 8 "

Avec verrou  
With ratchet  
Droit  
Straight



- DC50000-12**  
120 mm - 4 <sup>3</sup>/<sub>4</sub> "
- DC50000-14**  
145 mm - 5 <sup>3</sup>/<sub>4</sub> "
- DC50001-18** 
- 180 mm - 7 "
- DC50002-21** 
- 205 mm - 8 "
- DC50003-23** 
- 225 mm - 9 "

Avec verrou  
With ratchet  
Courbe  
Curved



- DC50010-12**  
120 mm - 4 <sup>3</sup>/<sub>4</sub> "
- DC50010-14**  
145 mm - 5 <sup>3</sup>/<sub>4</sub> "
- DC50011-18** 
- 180 mm - 7 "
- DC50012-21** 
- 205 mm - 8 "
- DC50013-23** 
- 225 mm - 9 "



Largeur 0,5 mm - Width 0.5 mm

**For** 8/0, 9/0, 10/0, 11/0  
*Suture*

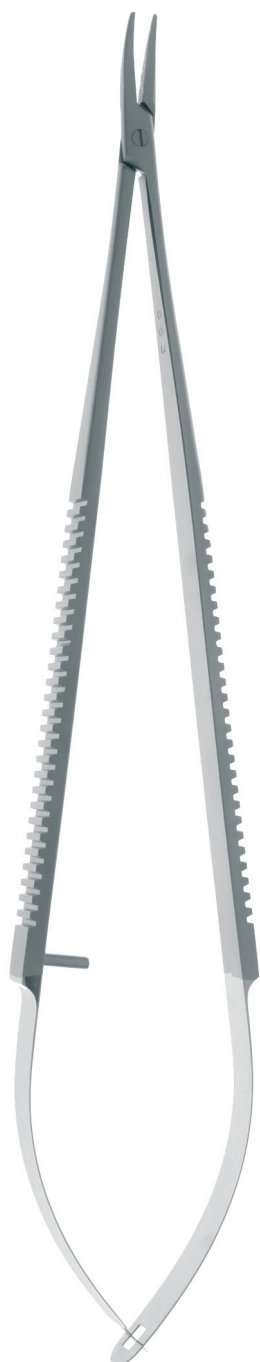

**DC50171-18**  
180 mm - 7 "

Sans verrou  
Without ratchet  
Droit  
Straight



**DC50160-14**

145 mm - 5 <sup>3</sup>/<sub>4</sub> "

**DC50161-18**

180 mm - 7 "

**DC50162-21**

215 mm - 8 <sup>1</sup>/<sub>2</sub> "



Sans verrou  
Without ratchet  
Courbe  
Curved



**DC50170-14**

145 mm - 5 <sup>3</sup>/<sub>4</sub> "

**DC50171-18**

180 mm - 7 "

**DC50172-21**

215 mm - 8 <sup>1</sup>/<sub>2</sub> "

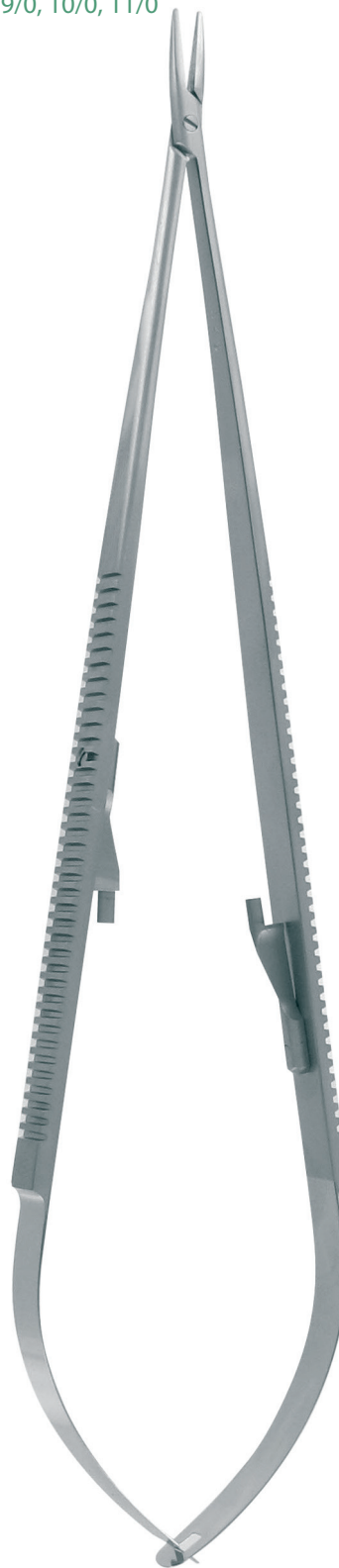

**DC50142-21**  
215 mm - 8 <sup>1</sup>/<sub>2</sub> "

Avec verrou  
With ratchet  
Droit  
Straight



**DC50140-14**

145 mm - 5 <sup>3</sup>/<sub>4</sub> "

**DC50141-18**

180 mm - 7 "

**DC50142-21**

215 mm - 8 <sup>1</sup>/<sub>2</sub> "



Avec verrou  
With ratchet  
Courbe  
Curved



**DC50150-14**

145 mm - 5 <sup>3</sup>/<sub>4</sub> "

**DC50151-18**

180 mm - 7 "

**DC50152-21**

215 mm - 8 <sup>1</sup>/<sub>2</sub> "





Largeur 0,5 mm - Width 0.5 mm

**For** 8/0, 9/0, 10/0, 11/0  
*Suture*

Sans verrou  
Without ratchet  
Droit  
Straight



**DC50120-12**  
120 mm - 4 <sup>3</sup>/<sub>4</sub> "

**DC50120-14**  
145 mm - 5 <sup>3</sup>/<sub>4</sub> "

**DC50121-18**   
180 mm - 7 "

**DC50122-21**   
205 mm - 8 "

**DC50123-23**   
225 mm - 9 "

**DC50124-25**  
250 mm - 9 <sup>4</sup>/<sub>5</sub> "

Sans verrou  
Without ratchet  
Courbe  
Curved



**DC50130-12**  
120 mm - 4 <sup>3</sup>/<sub>4</sub> "

**DC50130-14**  
145 mm - 5 <sup>3</sup>/<sub>4</sub> "

**DC50131-18**   
180 mm - 7 "

**DC50132-21**   
205 mm - 8 "

**DC50133-23**   
225 mm - 9 "

**DC50134-25**  
250 mm - 9 <sup>4</sup>/<sub>5</sub> "

Avec verrou  
With ratchet  
Droit  
Straight



**DC50100-12**  
120 mm - 4 <sup>3</sup>/<sub>4</sub> "

**DC50100-14**  
145 mm - 5 <sup>3</sup>/<sub>4</sub> "

**DC50101-18**   
180 mm - 7 "

**DC50102-21**   
205 mm - 8 "

**DC50103-23**   
225 mm - 9 "

**DC50104-25**  
250 mm - 9 <sup>4</sup>/<sub>5</sub> "

Avec verrou  
With ratchet  
Courbe  
Curved



**DC50110-12**  
120 mm - 4 <sup>3</sup>/<sub>4</sub> "

**DC50110-14**  
145 mm - 5 <sup>3</sup>/<sub>4</sub> "

**DC50111-18**   
180 mm - 7 "

**DC50112-21**   
205 mm - 8 "

**DC50113-23**   
225 mm - 9 "

**DC50114-25**  
250 mm - 9 <sup>4</sup>/<sub>5</sub> "

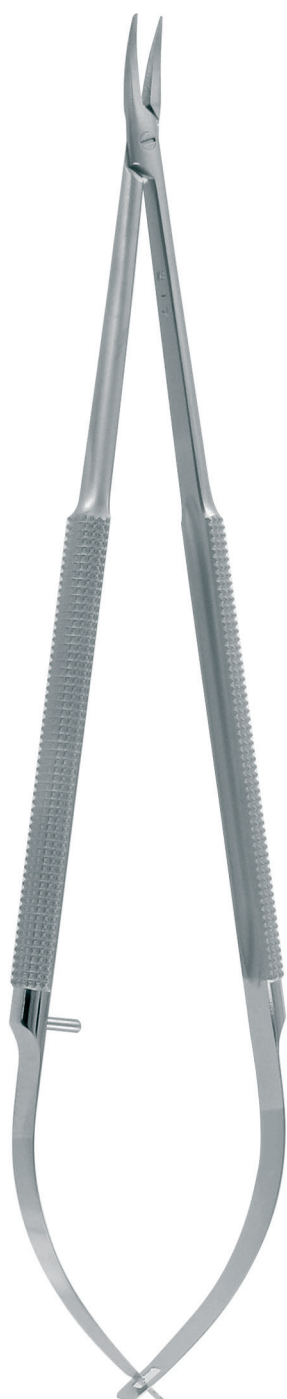

**DC50131-18**  
180 mm - 7 "



**DC50102-21**  
205 mm - 8 "



Largeur 0,8 mm - Width 0.8 mm

**For** Suture 7/0, 8/0, 9/0, 10/0

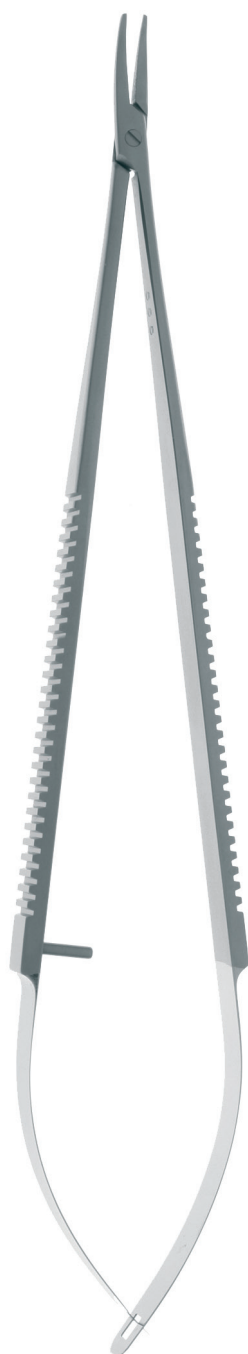

**DC50271-18**  
180 mm - 7 "

Sans verrou  
Without ratchet  
Droit  
Straight



- DC50260-14**  
145 mm - 5 <sup>3</sup>/<sub>4</sub> "
- DC50261-18**  
180 mm - 7 "
- DC50262-21**  
215 mm - 8 <sup>1</sup>/<sub>2</sub> "

Sans verrou  
Without ratchet  
Courbe  
Curved



- DC50270-14**  
145 mm - 5 <sup>3</sup>/<sub>4</sub> "
- DC50271-18**  
180 mm - 7 "
- DC50272-21**  
215 mm - 8 <sup>1</sup>/<sub>2</sub> "

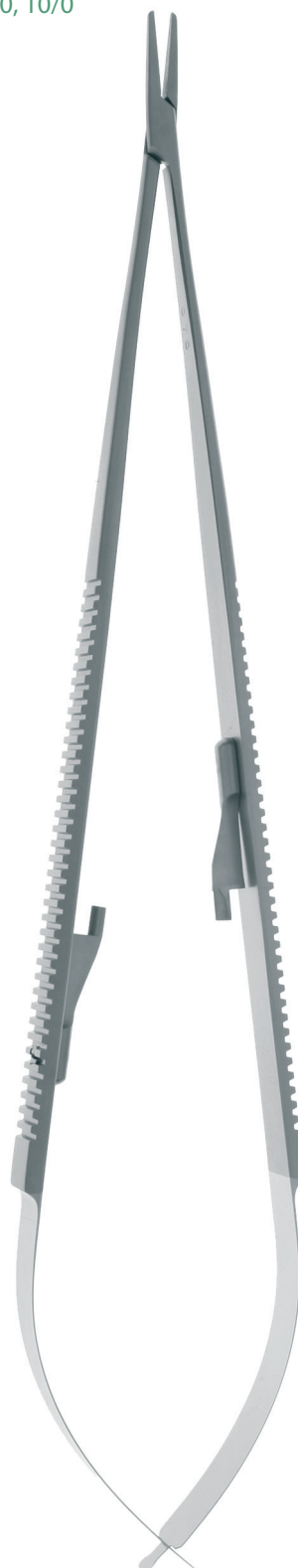

**DC50242-21**  
215 mm - 8 <sup>1</sup>/<sub>2</sub> "

Avec verrou  
With ratchet  
Droit  
Straight



- DC50240-14**  
145 mm - 5 <sup>3</sup>/<sub>4</sub> "
- DC50241-18**  
180 mm - 7 "
- DC50242-21**  
215 mm - 8 <sup>1</sup>/<sub>2</sub> "

Avec verrou  
With ratchet  
Courbe  
Curved



- DC50250-14**  
145 mm - 5 <sup>3</sup>/<sub>4</sub> "
- DC50251-18**  
180 mm - 7 "
- DC50252-21**  
215 mm - 8 <sup>1</sup>/<sub>2</sub> "



Largeur 0,8 mm - Width 0.8 mm

**For** 7/0, 8/0, 9/0, 10/0  
*Suture*

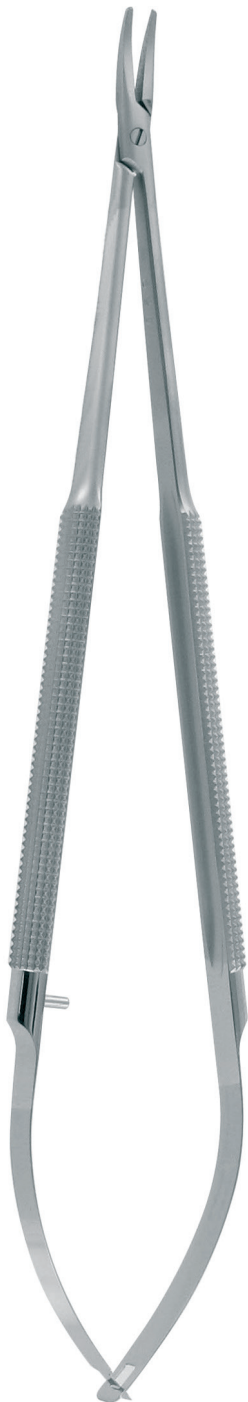

**DC50231-18**  
180 mm - 7 "

Sans verrou  
Without ratchet  
Droit  
Straight



- DC50220-12**  
120 mm - 4 <sup>3</sup>/<sub>4</sub> "
- DC50220-14**  
145 mm - 5 <sup>3</sup>/<sub>4</sub> "
- DC50221-18**  
180 mm - 7 "
- DC50222-21**  
205 mm - 8 "
- DC50223-23**  
225 mm - 9 "

Sans verrou  
Without ratchet  
Courbe  
Curved



- DC50230-12**  
120 mm - 4 <sup>3</sup>/<sub>4</sub> "
- DC50230-14**  
145 mm - 5 <sup>3</sup>/<sub>4</sub> "
- DC50231-18**  
180 mm - 7 "
- DC50232-21**  
205 mm - 8 "
- DC50233-23**  
225 mm - 9 "



**DC50202-21**  
205 mm - 8 "

Avec verrou  
With ratchet  
Droit  
Straight



- DC50200-12**  
120 mm - 4 <sup>3</sup>/<sub>4</sub> "
- DC50200-14**  
145 mm - 5 <sup>3</sup>/<sub>4</sub> "
- DC50201-18**  
180 mm - 7 "
- DC50202-21**  
205 mm - 8 "
- DC50203-23**  
225 mm - 9 "

Avec verrou  
With ratchet  
Courbe  
Curved



- DC50210-12**  
120 mm - 4 <sup>3</sup>/<sub>4</sub> "
- DC50210-14**  
145 mm - 5 <sup>3</sup>/<sub>4</sub> "
- DC50211-18**  
180 mm - 7 "
- DC50212-21**  
205 mm - 8 "
- DC50213-23**  
225 mm - 9 "



Largeur 1,0 mm - Width 1.0 mm

**For** 7/0, 8/0, 9/0  
*Suture*

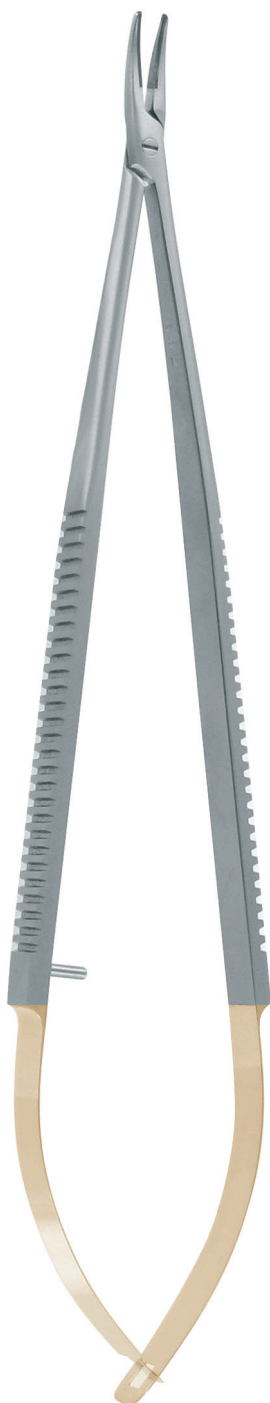

Sans verrou  
Without ratchet  
Droit  
Straight



**DC50310-14**

145 mm - 5 <sup>3</sup>/<sub>4</sub> "

**DC50311-18**

180 mm - 7 "

**DC50312-21**

215 mm - 8 <sup>1</sup>/<sub>2</sub> "

Sans verrou  
Without ratchet  
Courbe  
Curved



**DC50330-14**

145 mm - 5 <sup>3</sup>/<sub>4</sub> "

**DC50331-18**

180 mm - 7 "

**DC50332-21**

215 mm - 8 <sup>1</sup>/<sub>2</sub> "

**DC50331-18**

180 mm - 7 "

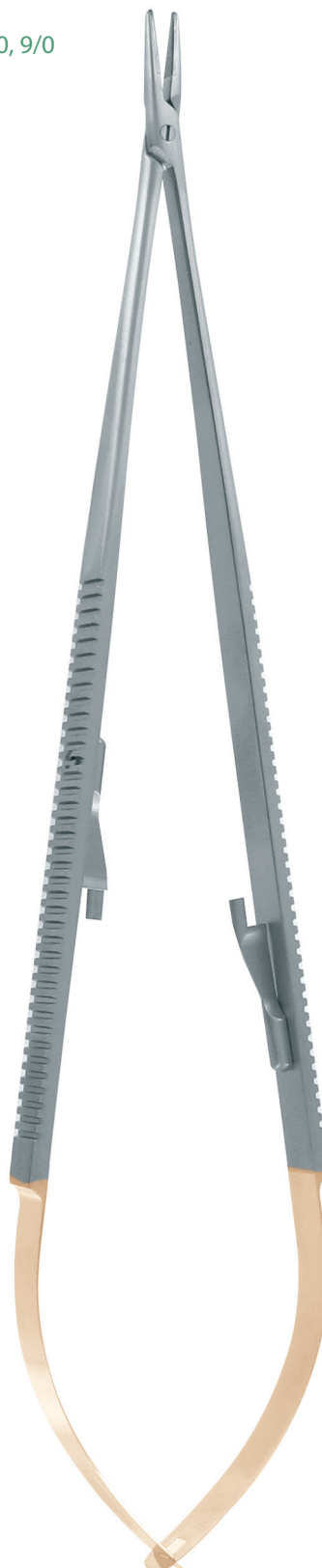

Avec verrou  
With ratchet  
Droit  
Straight



**DC50300-14**

145 mm - 5 <sup>3</sup>/<sub>4</sub> "

**DC50301-18**

180 mm - 7 "

**DC50302-21**

215 mm - 8 <sup>1</sup>/<sub>2</sub> "

Avec verrou  
With ratchet  
Courbe  
Curved



**DC50320-14**

145 mm - 5 <sup>3</sup>/<sub>4</sub> "

**DC50321-18**

180 mm - 7 "

**DC50322-21**

215 mm - 8 <sup>1</sup>/<sub>2</sub> "

**DC50302-21**

215 mm - 8 <sup>1</sup>/<sub>2</sub> "



Largeur 1,0 mm - Width 1.0 mm

**For** 7/0, 8/0, 9/0  
*Suture*



**DC50371-18**  
 180 mm - 7 "

Sans verrou  
 Without ratchet  
 Droit  
 Straight



- DC50350-12**  
120 mm - 4 <sup>3</sup>/<sub>4</sub> "
- DC50350-14**  
145 mm - 5 <sup>3</sup>/<sub>4</sub> "
- DC50351-18**  
180 mm - 7 "
- DC50352-21**  
205 mm - 8 "
- DC50353-23**  
225 mm - 9 "

Sans verrou  
 Without ratchet  
 Courbe  
 Curved



- DC50370-12**  
120 mm - 4 <sup>3</sup>/<sub>4</sub> "
- DC50370-14**  
145 mm - 5 <sup>3</sup>/<sub>4</sub> "
- DC50371-18**  
180 mm - 7 "
- DC50372-21**  
205 mm - 8 "
- DC50373-23**  
225 mm - 9 "



**DC50342-21**  
 205 mm - 8 "

Avec verrou  
 With ratchet  
 Droit  
 Straight



- DC50340-12**  
120 mm - 4 <sup>3</sup>/<sub>4</sub> "
- DC50340-14**  
145 mm - 5 <sup>3</sup>/<sub>4</sub> "
- DC50341-18**  
180 mm - 7 "
- DC50342-21**  
205 mm - 8 "
- DC50343-23**  
225 mm - 9 "

Avec verrou  
 With ratchet  
 Courbe  
 Curved



- DC50360-12**  
120 mm - 4 <sup>3</sup>/<sub>4</sub> "
- DC50360-14**  
145 mm - 5 <sup>3</sup>/<sub>4</sub> "
- DC50361-18**  
180 mm - 7 "
- DC50362-21**  
205 mm - 8 "
- DC50363-23**  
225 mm - 9 "





Largeur 1,2 mm - Width 1.2 mm

**For** 7/0, 8/0, 9/0  
*Suture*

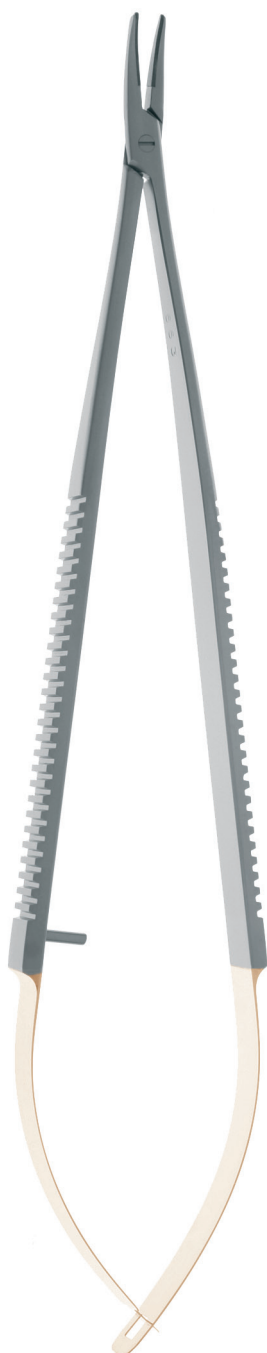

**DC50431-18**  
180 mm - 7 "

Sans verrou  
Without ratchet  
Droit  
Straight



- DC50410-14**  
145 mm - 5 3/4 "
- DC50411-18**  
180 mm - 7 "
- DC50412-21**  
215 mm - 8 1/2 "

Sans verrou  
Without ratchet  
Courbe  
Curved



- DC50430-14**  
145 mm - 5 3/4 "
- DC50431-18**  
180 mm - 7 "
- DC50432-21**  
215 mm - 8 1/2 "

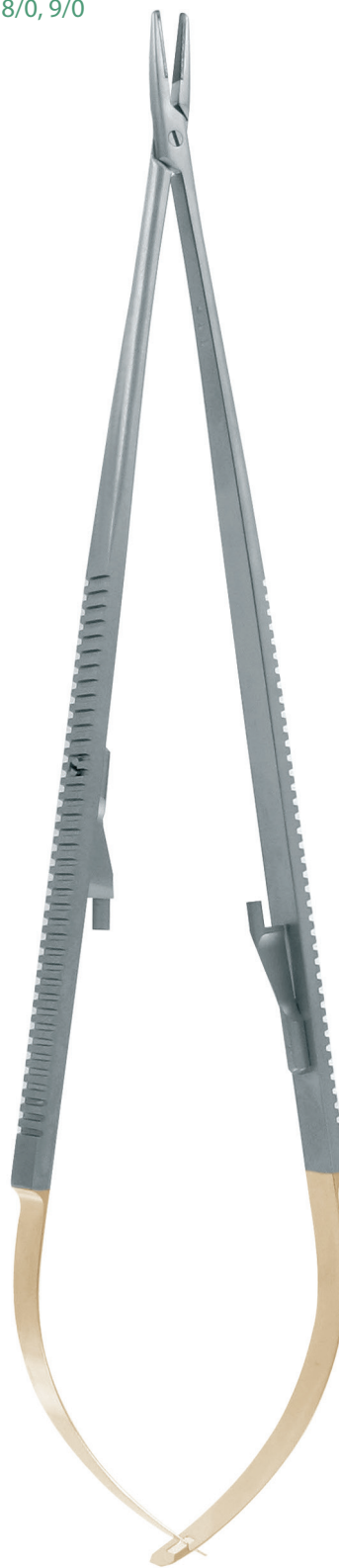

**DC50402-21**  
215 mm - 8 1/2 "

Avec verrou  
With ratchet  
Droit  
Straight



- DC50400-14**  
145 mm - 5 3/4 "
- DC50401-18**  
180 mm - 7 "
- DC50402-21**  
215 mm - 8 1/2 "

Avec verrou  
With ratchet  
Courbe  
Curved



- DC50420-14**  
145 mm - 5 3/4 "
- DC50421-18**  
180 mm - 7 "
- DC50422-21**  
215 mm - 8 1/2 "



Largeur 1,2 mm - Width 1.2 mm

**For** 7/0, 8/0, 9/0  
*Suture*

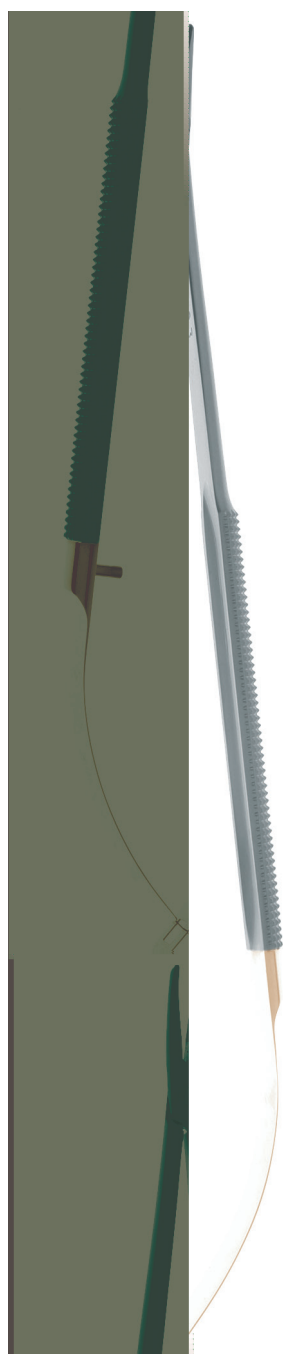

**DC50471-18**  
180 mm - 7 "

Sans verrou  
Without ratchet  
Droit  
Straight



- DC50450-14**  
145 mm - 5 <sup>3</sup>/<sub>4</sub> "
- DC50451-18**  
180 mm - 7 "
- DC50452-21**  
205 mm - 8 "
- DC50453-23**   
225 mm - 9 "

Sans verrou  
Without ratchet  
Courbe  
Curved



- DC50470-14**  
145 mm - 5 <sup>3</sup>/<sub>4</sub> "
- DC50471-18**  
180 mm - 7 "
- DC50472-21**  
205 mm - 8 "
- DC50473-23**   
225 mm - 9 "



**DC50442-21**  
205 mm - 8 "

Avec verrou  
With ratchet  
Droit  
Straight



- DC50440-14**  
145 mm - 5 <sup>3</sup>/<sub>4</sub> "
- DC50441-18**  
180 mm - 7 "
- DC50442-21**  
205 mm - 8 "
- DC50443-23**   
225 mm - 9 "

Avec verrou  
With ratchet  
Courbe  
Curved



- DC50460-14**  
145 mm - 5 <sup>3</sup>/<sub>4</sub> "
- DC50461-18**  
180 mm - 7 "
- DC50462-21**  
205 mm - 8 "
- DC50463-23**   
225 mm - 9 "

Largeur 1,5 mm - Width 1.5 mm

**For** 6/0, 7/0, 8/0  
*Suture*

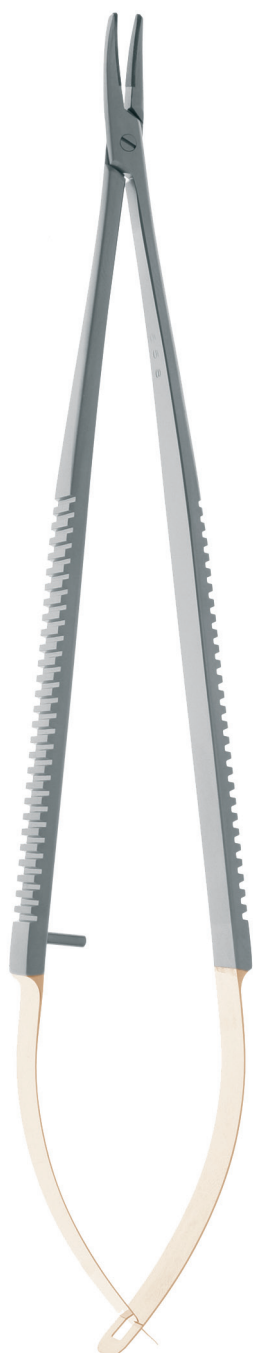

**DC50531-18**  
180 mm - 7 "

Sans verrou  
Without ratchet  
Droit  
Straight



- DC50510-14**  
145 mm - 5 <sup>3</sup>/<sub>4</sub> "
- DC50511-18**  
180 mm - 7 "
- DC50512-21**  
215 mm - 8 <sup>1</sup>/<sub>2</sub> "

Sans verrou  
Without ratchet  
Courbe  
Curved



- DC50530-14**  
145 mm - 5 <sup>3</sup>/<sub>4</sub> "
- DC50531-18**  
180 mm - 7 "
- DC50532-21**  
215 mm - 8 <sup>1</sup>/<sub>2</sub> "

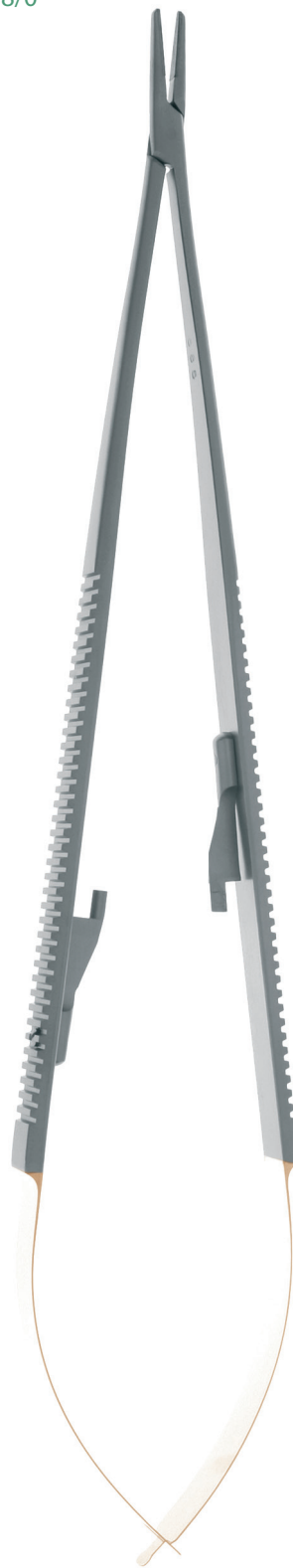

**DC50502-21**  
215 mm - 8 <sup>1</sup>/<sub>2</sub> "

Avec verrou  
With ratchet  
Droit  
Straight



- DC50500-14**  
145 mm - 5 <sup>3</sup>/<sub>4</sub> "
- DC50501-18**  
180 mm - 7 "
- DC50502-21**  
215 mm - 8 <sup>1</sup>/<sub>2</sub> "

Avec verrou  
With ratchet  
Courbe  
Curved



- DC50520-14**  
145 mm - 5 <sup>3</sup>/<sub>4</sub> "
- DC50521-18**  
180 mm - 7 "
- DC50522-21**  
215 mm - 8 <sup>1</sup>/<sub>2</sub> "



Largeur 1,5 mm - Width 1.5 mm

**For** 6/0, 7/0, 8/0  
*Suture*

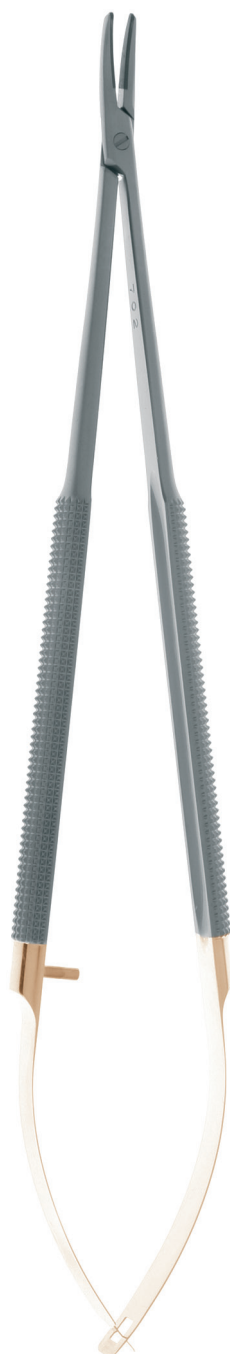

Sans verrou  
Without ratchet  
Droit  
Straight



- DC50550-14**  
145 mm - 5 3/4 "
- DC50551-18**  
180 mm - 7 "
- DC50552-21**  
205 mm - 8 "
- DC50553-23**  
225 mm - 9 "

Sans verrou  
Without ratchet  
Courbe  
Curved



- DC50570-14**  
145 mm - 5 3/4 "
- DC50571-18**  
180 mm - 7 "
- DC50572-21**  
205 mm - 8 "
- DC50573-23**  
225 mm - 9 "

**DC50571-18**  
180 mm - 7 "



Avec verrou  
With ratchet  
Droit  
Straight



- DC50540-14**  
145 mm - 5 3/4 "
- DC50541-18**  
180 mm - 7 "
- DC50542-21**  
205 mm - 8 "
- DC50543-23**  
225 mm - 9 "

Avec verrou  
With ratchet  
Courbe  
Curved



- DC50560-14**  
145 mm - 5 3/4 "
- DC50561-18**  
180 mm - 7 "
- DC50562-21**  
205 mm - 8 "
- DC50563-23**  
225 mm - 9 "

**DC50542-21**  
205 mm - 8 "

### HEAVY STYLE JACOBSON



Manche rond Ø 10 mm - Streamline - Round Handle Ø 10 mm - Streamline



Streamline Design



**DC50631-19**  
190 mm - 7 1/2 "

Sans verrou  
Without ratchet  
Droit  
Straight



**DC50631-19**

190 mm - 7 1/2 "



**DC50635-23**

230 mm - 9 "



**DC50641-25**

250 mm - 10 "



Sans verrou  
Without ratchet  
Courbe  
Curved



**DC50633-19**

190 mm - 7 1/2 "



**DC50637-23**

230 mm - 9 "



**DC50643-25**

250 mm - 10 "

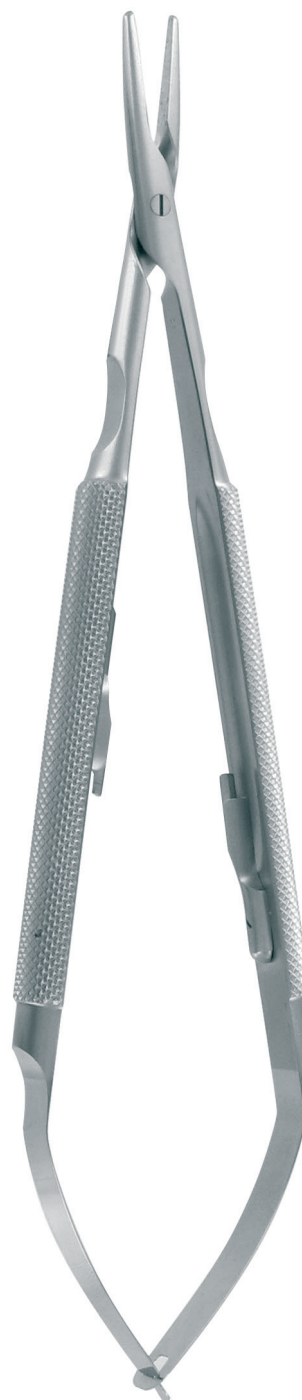

**DC50630-19**  
190 mm - 7 1/2 "

Avec verrou  
With ratchet  
Droit  
Straight



**DC50630-19**

190 mm - 7 1/2 "



**DC50634-23**

230 mm - 9 "



**DC50640-25**

250 mm - 10 "



Avec verrou  
With ratchet  
Courbe  
Curved



**DC50632-19**

190 mm - 7 1/2 "



**DC50636-23**

230 mm - 9 "



**DC50642-25**

250 mm - 10 "



JACOBSON

II - Micro-instruments  
II - Micro-instruments



Largeur 1,2 mm - Width 1.2 mm

**For** 8/0, 9/0  
*Suture*

Sans verrou  
Without ratchet  
Droit  
Straight



**DC50611-23**  
230 mm - 9 "



Sans verrou  
Without ratchet  
Courbe  
Curved



**DC50613-23**  
230 mm - 9 "



**DC50613-23**  
230 mm - 9 "

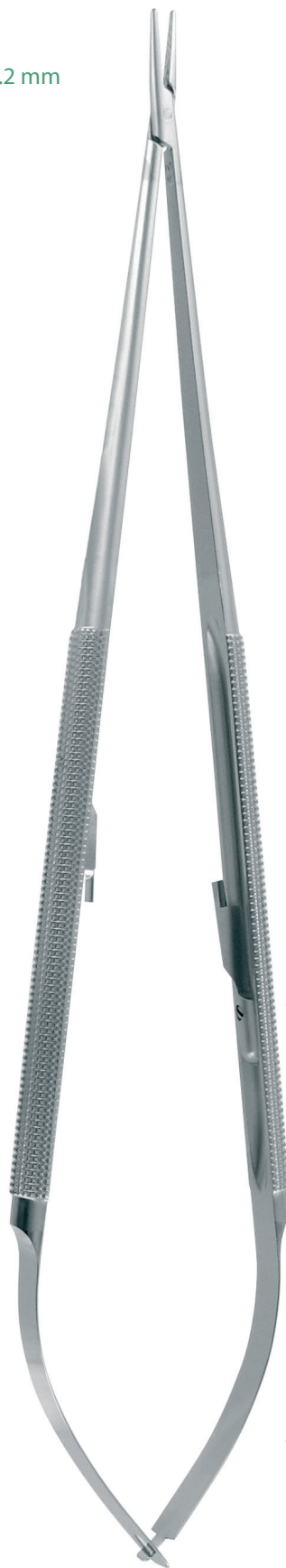

Avec verrou  
With ratchet  
Droit  
Straight



**DC50610-23**  
230 mm - 9 "



Avec verrou  
With ratchet  
Courbe  
Curved



**DC50612-23**  
230 mm - 9 "



**DC50610-23**  
230 mm - 9 "

### JACOBSON

### CASTROVIEJO



Diamonte

**For** 8/0, 9/0, 10/0  
*Suture*

II - Micro-instruments  
II - Micro-instruments

À anneaux - Avec verrou  
Ring Handle - With ratchet  
Droit  
Straight

**DC50614-18**

185 mm - 7 1/4 "

**DC50616-23**

230 mm - 9 "

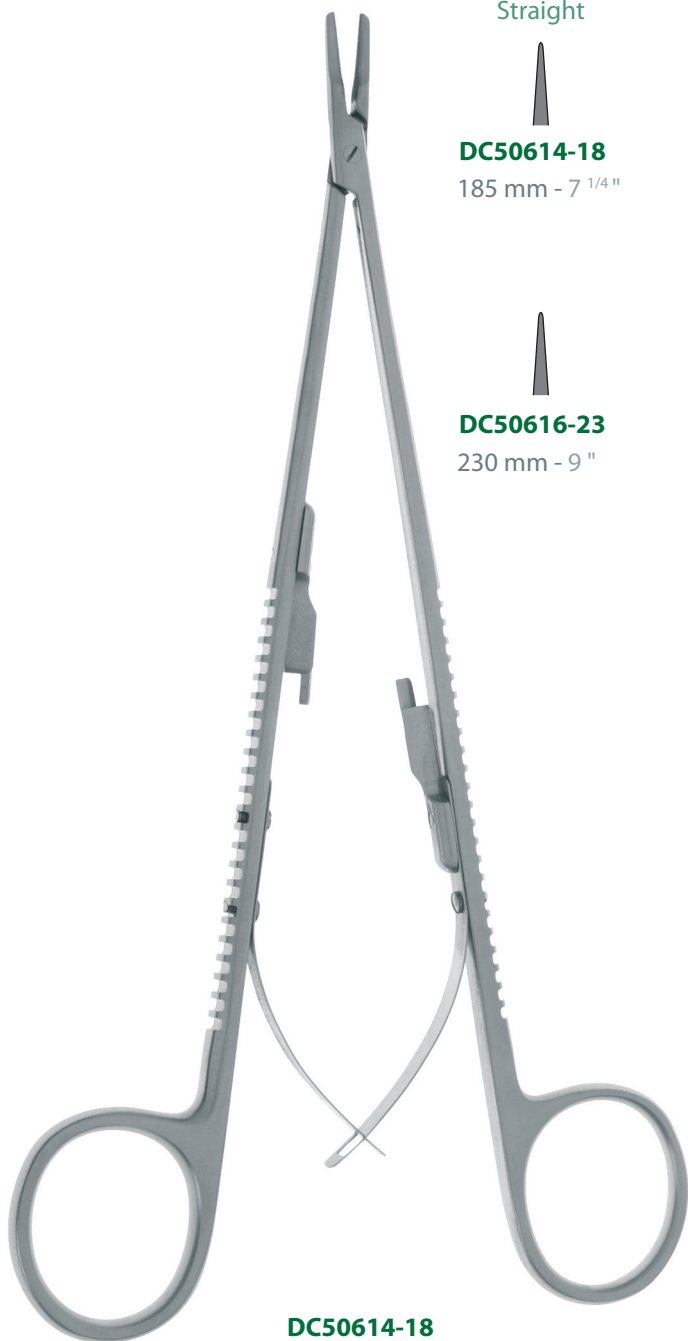

**DC50614-18**

185 mm - 7 1/4 "

Avec verrou  
With ratchet  
Droit  
Straight

**DC50661-14**

140 mm - 5 1/2 "

Courbe  
Curved

**DC50662-14**

140 mm - 5 1/2 "

Sans verrou  
Without ratchet  
Droit  
Straight

**DC50663-14**

140 mm - 5 1/2 "

Courbe  
Curved

**DC50664-14**

140 mm - 5 1/2 "

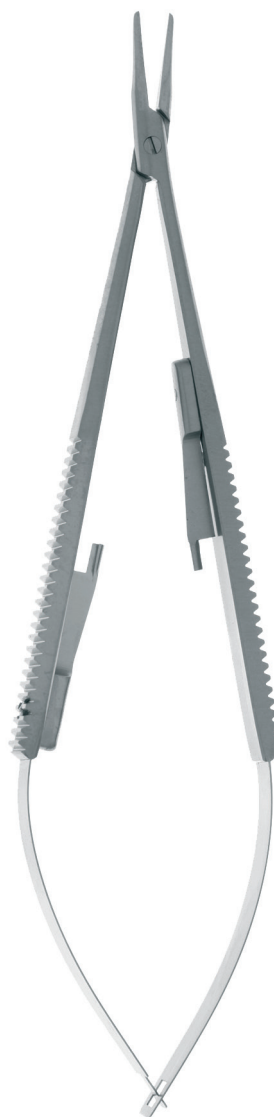

**DC50661-14**

140 mm - 5 1/2 "

### 3 ARTICULATIONS



Contrebalancé - Largeur 1,0 - Counterbalanced - Width 1.0 mm

**For** 8/0, 9/0, 10/0  
*Suture*

II - Micro-instruments  
II - Micro-instruments



Diamonite  
Counterbalanced



Sans verrou  
Without ratchet  
Droit  
Straight

**DC50621-23**  
230 mm - 9 "

Sans verrou  
Without ratchet  
Courbe  
Curved

**DC50623-23**  
230 mm - 9 "

**DC50623-23**  
230 mm - 9 "

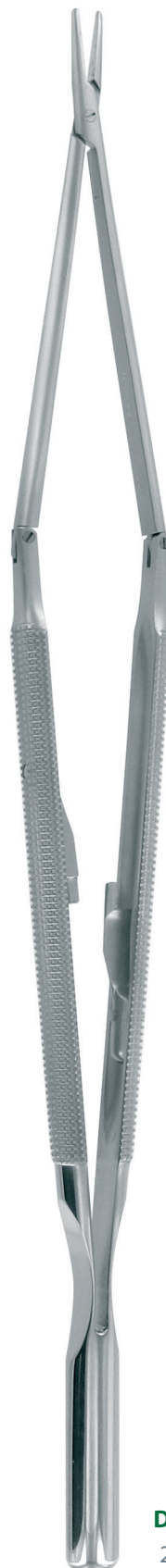

Avec verrou  
With ratchet  
Droit  
Straight

**DC50620-23**  
230 mm - 9 "

Avec verrou  
With ratchet  
Courbe  
Curved

**DC50622-23**  
230 mm - 9 "

**DC50620-23**  
230 mm - 9 "



VASCULAR



Pitch 0,3 mm - Pitch 0.3 mm

**For** 7/0, 8/0, 9/0  
*Suture*



II - Micro-instruments  
II - Micro-instruments

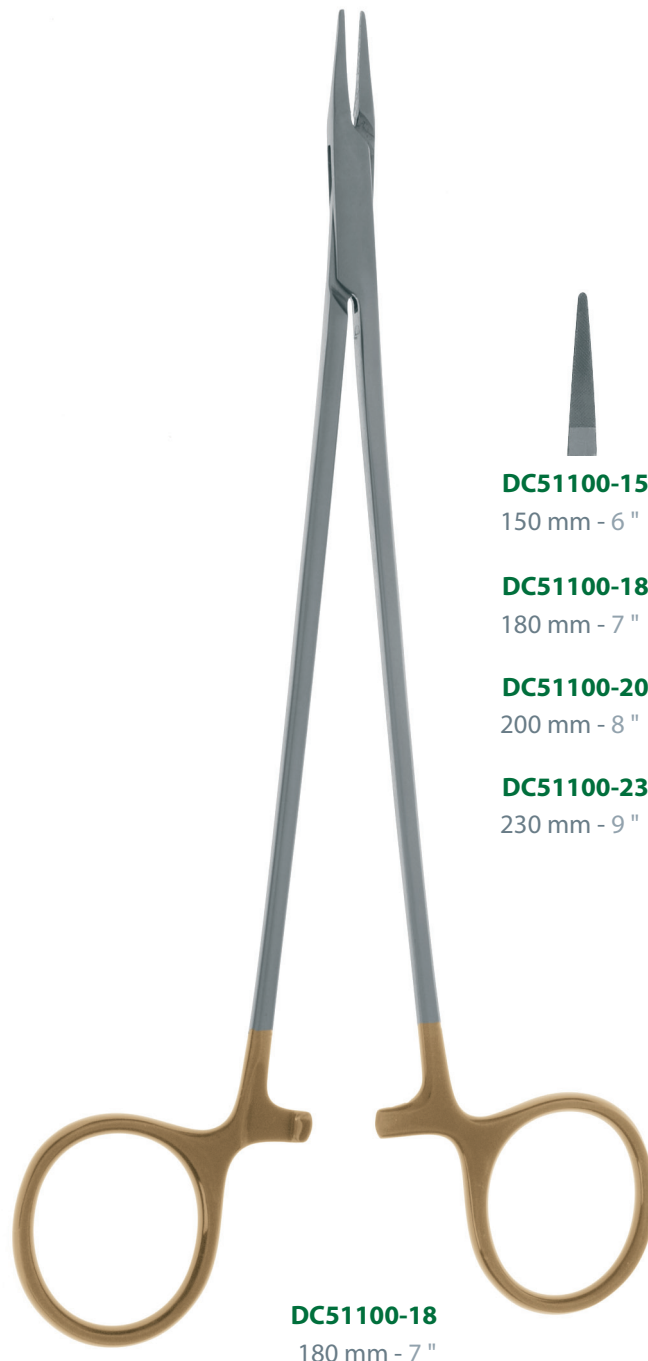

**DC51100-15**  
150 mm - 6 "

**DC51100-18**  
180 mm - 7 "

**DC51100-20**  
200 mm - 8 "

**DC51100-23**  
230 mm - 9 "

**DC51100-18**  
180 mm - 7 "

MICRO RYDER



Pitch 0,3 mm - Pitch 0.3 mm

**For** 7/0, 8/0, 9/0  
*Suture*



II - Micro-instruments  
II - Micro-instruments

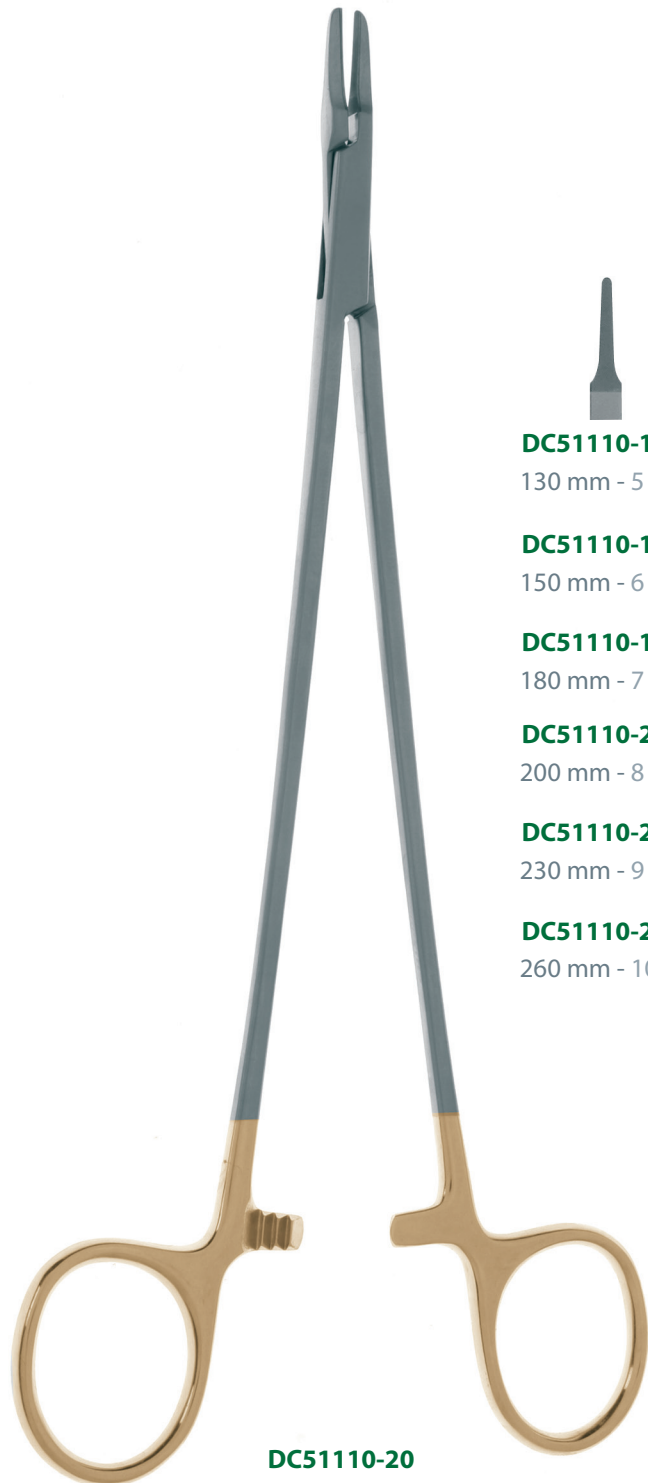

**DC51110-13**

130 mm - 5 "

**DC51110-15**

150 mm - 6 "

**DC51110-18**

180 mm - 7 "

**DC51110-20**

200 mm - 8 "

**DC51110-23**

230 mm - 9 "

**DC51110-26**

260 mm - 10 "

**DC51110-20**

200 mm - 8 "

McINDOE



9 mm

**DC34205-09**

15 cm - 6 "

10 mm

**DC34205-10**

15 cm - 6 "

**DC34205-09**

15 cm - 6 "

COTTLE



II - Micro-instruments  
II - Micro-instruments



**B803550**  
16 cm - 6 1/4"



**B803551**  
16 cm - 6 1/4"

### KRAYENBUHL

### ADSON



Embout à boule  
Ball Tip



**DC34400-00**  
185 mm - 7 1/4 "



**DC34400-01**  
185 mm - 7 1/4 "

Embout mousse  
Blunt Tip



**DC34400-02**  
185 mm - 7 1/4 "

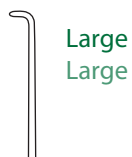

**DC34400-03**  
185 mm - 7 1/4 "

**DC34400-01**  
185 mm - 7 1/4 "



Embout mousse  
Blunt Tip



**DC34410-01**  
190 mm - 7 1/2 "

Embout pointu  
Sharp Tip



**DC34410-02**  
190 mm - 7 1/2 "

**DC34410-01**  
190 mm - 7 1/2 "

TÖNNIS

NATALI

CASPAR



II - Micro-instruments  
II - Micro-instruments



Mousse  
Blunt

Etroit  
Narrow



**DC34200-01**  
240 mm - 10 "

Large  
Large



**DC34200-02**  
240 mm - 10 "



**DC34100-00**  
200 mm - 7 1/2 "



5 mm  
Pousse-noeud  
Knot pusher

**DC34210-10**  
230 mm - 9 "

CASPAR



### CASPAR

### JACOBSON



II - Micro-instruments  
II - Micro-instruments

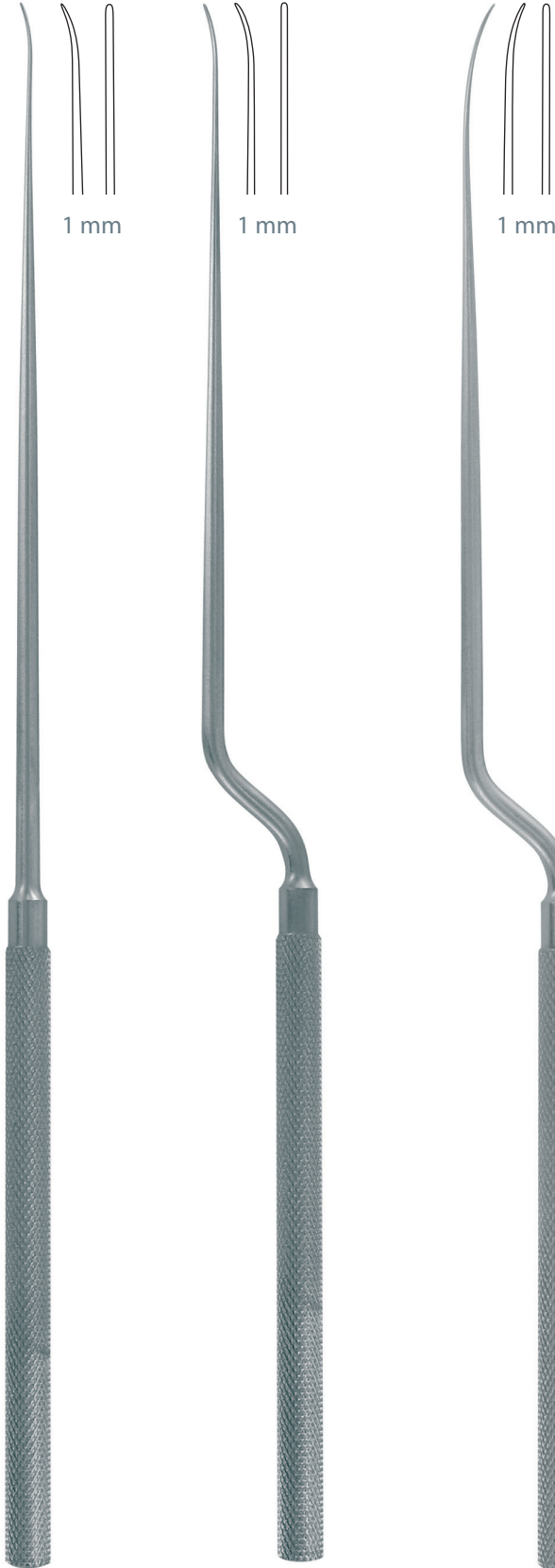

**DC34210-07**  
220 mm - 8 3/4 "

**DC34210-08**  
220 mm - 8 3/4 "

**DC34210-09**  
220 mm - 8 3/4 "

Sonde avec boules  
Probe with ball tip

Coudée  
Angled

Support pour vaisseaux  
Vessel supporter



**DC34208-01**  
185 mm - 7 "

**DC34208-02**  
185 mm - 7 "



YASARGIL

Micro rugine  
Micro raspatory

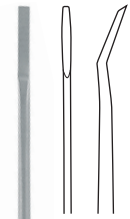

Coudée  
Angled



**DC34220-01**  
185 mm - 7 "

Micro dissecteur  
Micro dissector



Coudée  
Angled



**DC34220-02**  
185 mm - 7 "

Micro rugine  
Micro raspatory



Coudée  
Angled



**DC34220-03**  
185 mm - 7 "

Micro rugine  
Micro raspatory



Courbe  
Curved



**DC34220-04**  
185 mm - 7 "

Micro rugine  
Micro raspatory



Très courbe  
Strongly curved



**DC34220-05**  
185 mm - 7 "



### SAMII

### JACOBSON

### FISCH

Micro couteaux pour tumeur  
Micro knives for tumor

II - Micro-instruments  
II - Micro-instruments

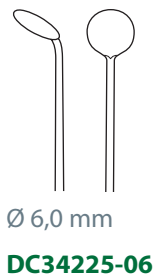
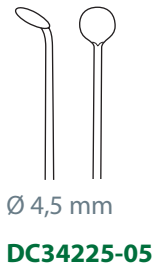

**DC34225-05**  
230 mm - 9 "

Micro couteau à vaisseaux  
Micro vessel knife



**DC34230-03**  
185 mm - 7 "

Micro crochet  
Micro hook



Pointu, coudé 90°  
Sharp, angled 90°

**DC34230-01**  
185 mm - 7 "

KOOS

YASARGIL



Micro couteaux à vaisseaux  
Micro vessel knives



Courbe en haut  
Curved up  
**DC34250-18**



Courbe en bas  
Curved down  
**DC34251-18**

**DC34250-18**  
185 mm - 7 "



Courbe en haut  
Curved up  
**DC34256-18**



Courbe en bas  
Curved down  
**DC34255-18**

**DC34256-18**  
185 mm - 7 "



## Canules aspiratrices - Suction tubes

BABY YANKAUER



P 1

YANKAUER



P 1

ANDREWS-PYNCHON



P 1

DEBAKEY



P 2

FUKUSHIMA



P 3

FRAZIER



P 4

FERGUSSON



P 5

PLESTER



P 6

VERHOEVEN



P 7

BARON



P 8

SCHUHKNECHT



P 9

CONE



P 10

FRAZIER



P 10



### YANKAUER

Avec embout amovible  
With removable tip

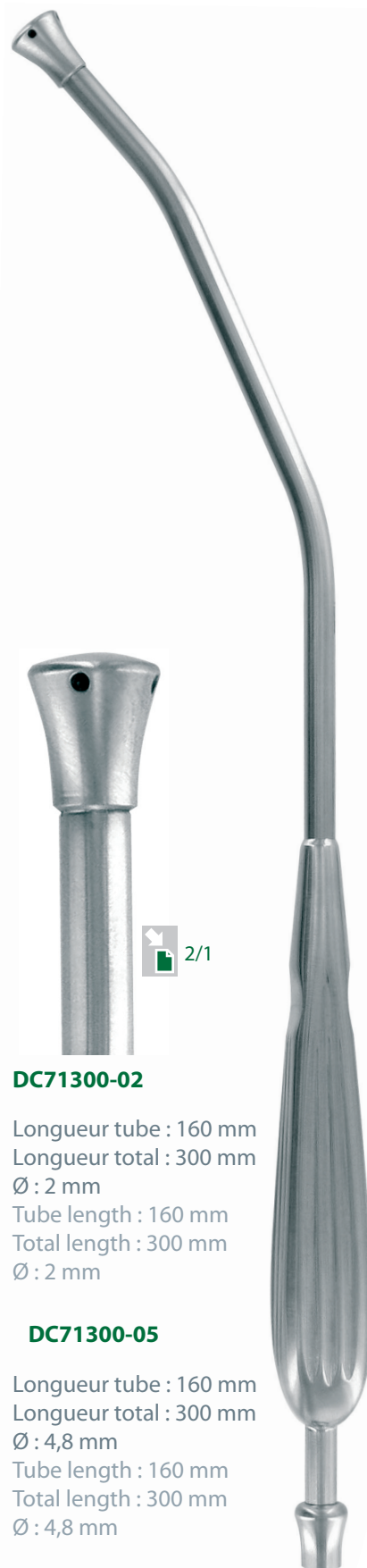

### ANDREWS-PYNCHON

#### BABY YANKAUER

Avec embout amovible  
With removable tip



#### DC71320-02

Longueur tube : 110 mm  
Longueur total : 210 mm  
Ø : 1,8 mm  
Tube length : 110 mm  
Total length : 210 mm  
Ø : 1,8 mm

#### DC71310-02

Longueur tube : 100 mm  
Longueur total : 240 mm  
Ø : 2 mm  
Tube length : 100 mm  
Total length : 240 mm  
Ø : 2 mm

#### DC71300-02

Longueur tube : 160 mm  
Longueur total : 300 mm  
Ø : 2 mm  
Tube length : 160 mm  
Total length : 300 mm  
Ø : 2 mm

#### DC71300-05

Longueur tube : 160 mm  
Longueur total : 300 mm  
Ø : 4,8 mm  
Tube length : 160 mm  
Total length : 300 mm  
Ø : 4,8 mm

### DEBAKEY



Avec embout amovible - Connecteur Luer mâle  
With removable tip - Male Luer connector

III - Canules d'aspiration  
III - Suction tubes



**DC71330-03**

L : 285 mm  
Ø : 3 mm



### FUKUSHIMA

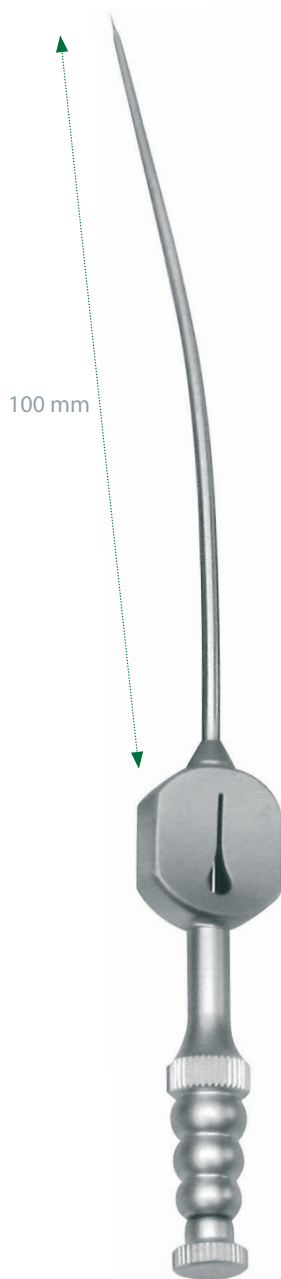

**DC71396-04**  
16,5 cm - 6 1/2 "

III - Canules d'aspiration  
III - Suction tubes

Longueur utile - Working length	100 mm	115 mm	140 mm	165 mm
Longueur totale - Total length	165 mm	180 mm	205 mm	230 mm

CH 4 - Ø : 1,3 mm ○	<b>DC71396-04</b>	<b>DC71397-04</b>	<b>DC71398-04</b>	<b>DC71399-04</b>
CH 5 - Ø : 1,7 mm ○	<b>DC71396-05</b>	<b>DC71397-05</b>	<b>DC71398-05</b>	<b>DC71399-05</b>
CH 6 - Ø : 2,0 mm ○	<b>DC71396-06</b>	<b>DC71397-06</b>	<b>DC71398-06</b>	<b>DC71399-06</b>
CH 7 - Ø : 2,3 mm ○	<b>DC71396-07</b>	<b>DC71397-07</b>	<b>DC71398-07</b>	<b>DC71399-07</b>
CH 8 - Ø : 2,7 mm ○	<b>DC71396-08</b>	<b>DC71397-08</b>	<b>DC71398-08</b>	<b>DC71399-08</b>
CH 9 - Ø : 3,0 mm ○	<b>DC71396-09</b>	<b>DC71397-09</b>	<b>DC71398-09</b>	<b>DC71399-09</b>
CH 12 - Ø : 4,0 mm ○	<b>DC71396-12</b>	<b>DC71397-12</b>	<b>DC71398-12</b>	<b>DC71399-12</b>

### FRAZIER



III - Canules d'aspiration  
III - Suction tubes

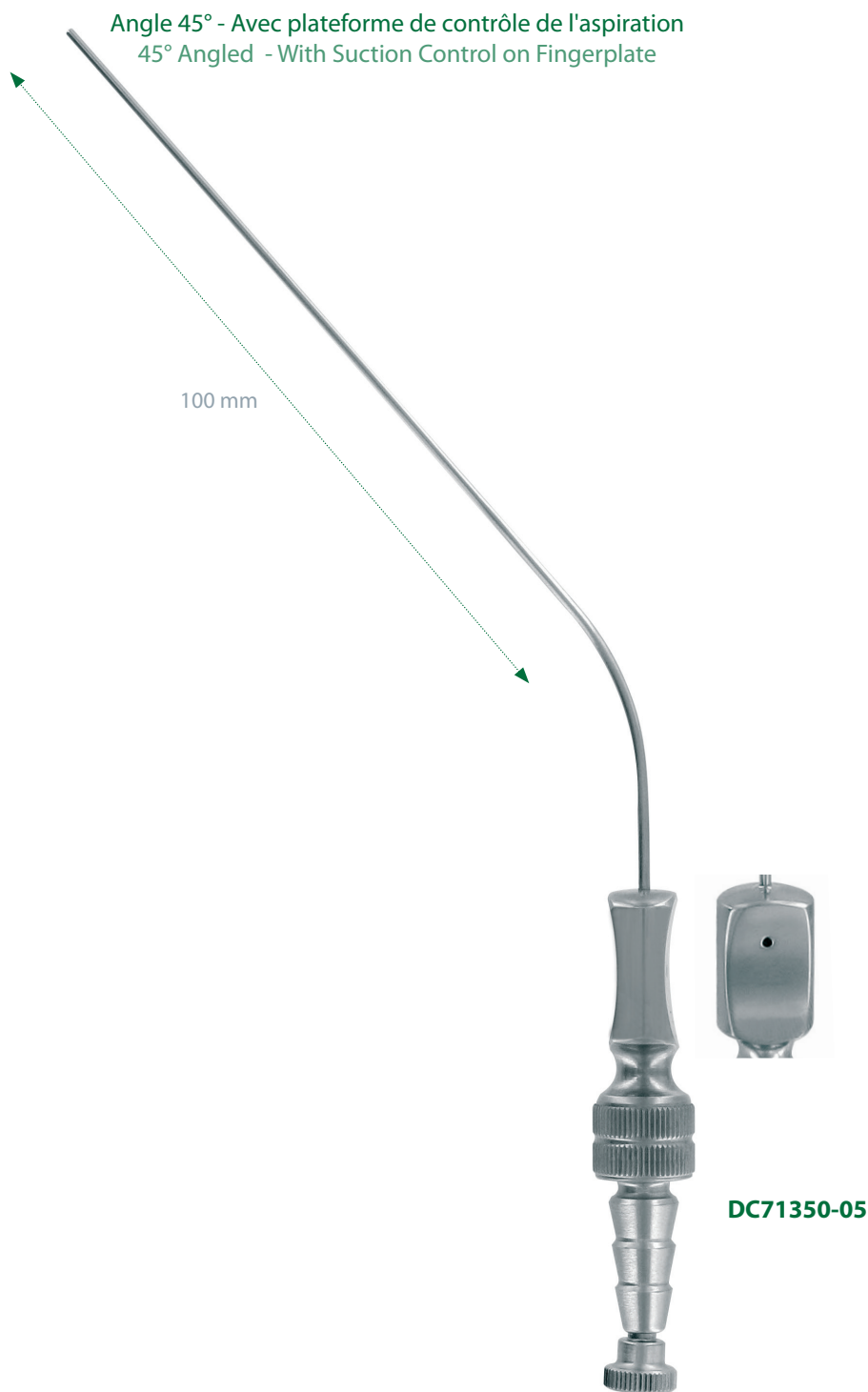

Longueur utile - Working length	110 mm	130 mm	150 mm	190 mm
CH 5 - Ø : 1,7 mm ○	DC71349-05	DC71350-05	DC71354-05	DC71355-05
CH 6 - Ø : 2,0 mm ○	DC71349-06	DC71350-06	DC71354-06	DC71355-06
CH 8 - Ø : 2,5 mm ○	DC71349-08	DC71350-08	DC71354-08	DC71355-08
CH 9 - Ø : 3,0 mm ○	DC71349-09	DC71350-09	DC71354-09	DC71355-09
CH 12 - Ø : 4,0 mm ○	DC71349-12	DC71350-12	DC71354-12	DC71355-12
CH 15 - Ø : 5,0 mm ○	DC71349-15	DC71350-15	DC71354-15	DC71355-15

### FERGUSSON



Isolée - Insulated



Longueur totale - Total length

180 mm

CH 12 - Ø : 4,0 mm ○

DC71345-12

### PLESTER

III - Canules d'aspiration  
III - Suction tubes



**I182025**

19,5 cm - 7 <sup>3</sup>/<sub>4</sub> "

Longueur utile - Working length 

135 mm
--------

CH 5 - Ø : 1,5 mm ○ 

<b>I182015</b>
----------------

CH 6 - Ø : 2,0 mm ○ 

<b>I182020</b>
----------------

CH 8 - Ø : 2,5 mm ○ 

<b>I182025</b>
----------------

CH 9 - Ø : 3,0 mm ○ 

<b>I182030</b>
----------------

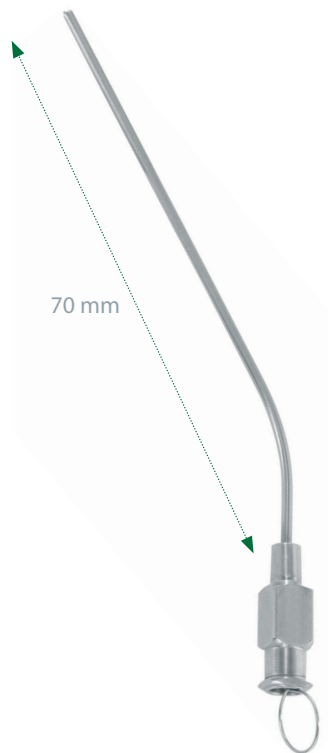

**DC71394-12**  
10 cm - 4 "

Longueur utile - Working length	70 mm
Gauge : 25 - Ø : 0,5 mm ·	<b>DC71394-05</b>
Gauge : 22 - Ø : 0,7 mm ·	<b>DC71394-07</b>
Gauge : 19 - Ø : 1,0 mm ·	<b>DC71394-10</b>
Gauge : 18 - Ø : 1,2 mm ·	<b>DC71394-12</b>
Gauge : 17 - Ø : 1,5 mm ·	<b>DC71394-15</b>

### BARON

Angle 45° - Avec plateforme de contrôle de l'aspiration  
 45° Angled - With Suction Control on Fingerplate



Longueur utile - Working length	75 mm	100 mm
CH 3 - Ø : 1,0 mm ◦	DC71360-03	DC71361-03
CH 5 - Ø : 1,7 mm ◦	DC71360-05	DC71361-05
CH 7 - Ø : 2,3 mm ○	DC71360-07	DC71361-07

### SCHUHKNECHT



Angle 45° - Avec plateforme de contrôle de l'aspiration  
 45° Angled - With Suction Control on Fingerplate

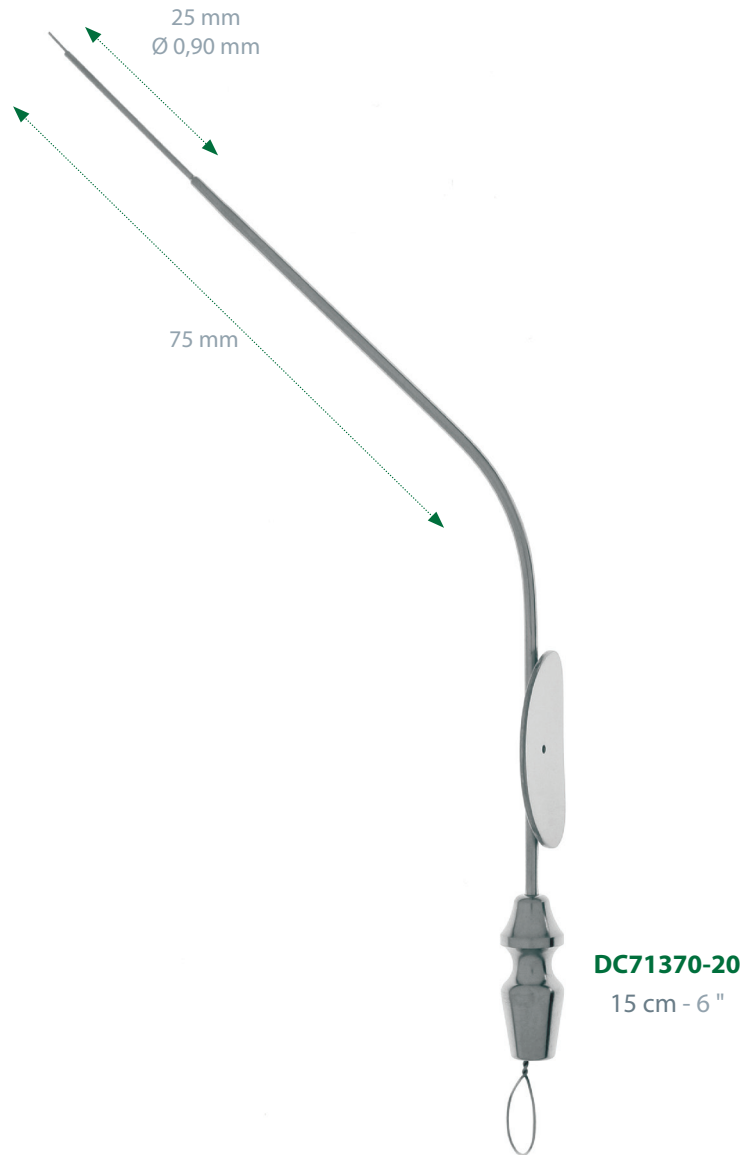

Longueur utile - Working length	75 mm
Gauge : 20 - Ø : 0,90 mm	DC71370-20
Gauge : 24 - Ø : 0,55 mm	DC71370-40

### CONE

### FRAZIER

III - Canules d'aspiration  
III - Suction tubes

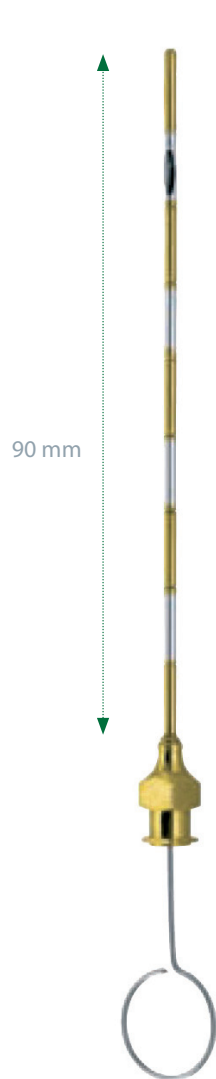

Longueur utile - Working length 

90 mm
-------

CH 5 - Ø : 1,7 mm ○ 

DC71390-05
------------

CH 6 - Ø : 2,0 mm ○ 

DC71390-06
------------

Longueur utile - Working length 

100 mm
--------

CH 6 - Ø : 2,0 mm ○ 

DC71391-06
------------

CH 9 - Ø : 3,0 mm ○ 

DC71391-09
------------



## Écarteurs - Retractors

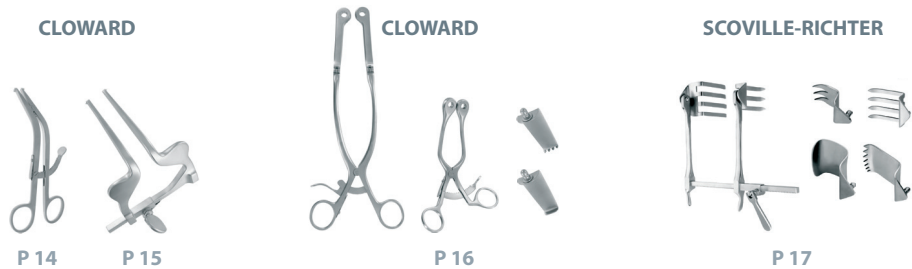
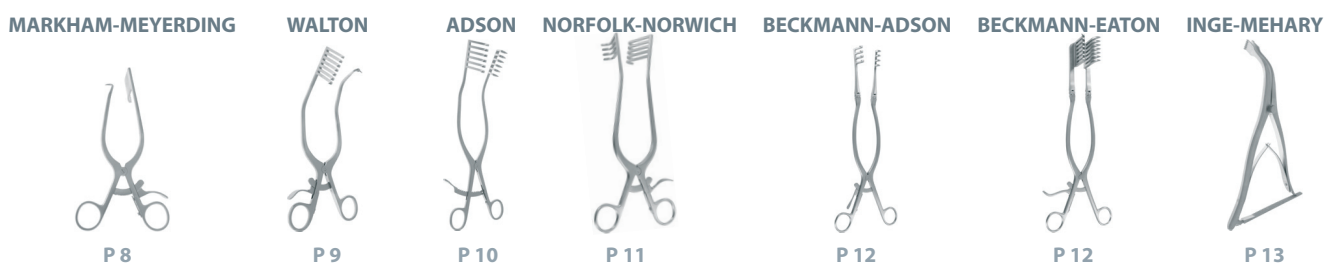
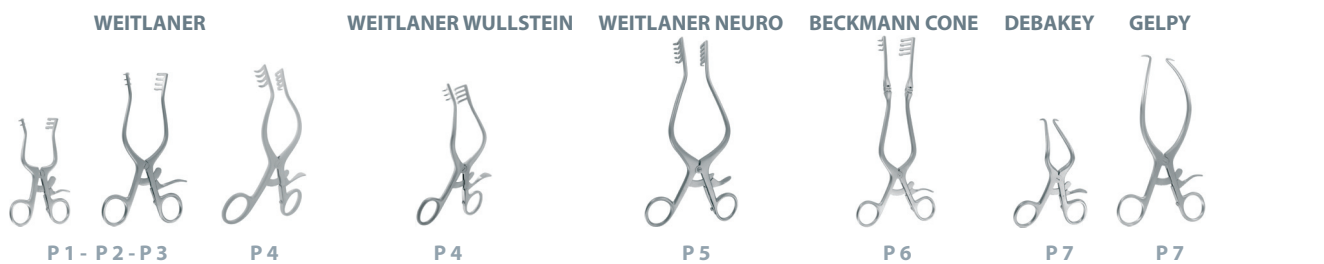

## Contre écarteur - Counter retractor

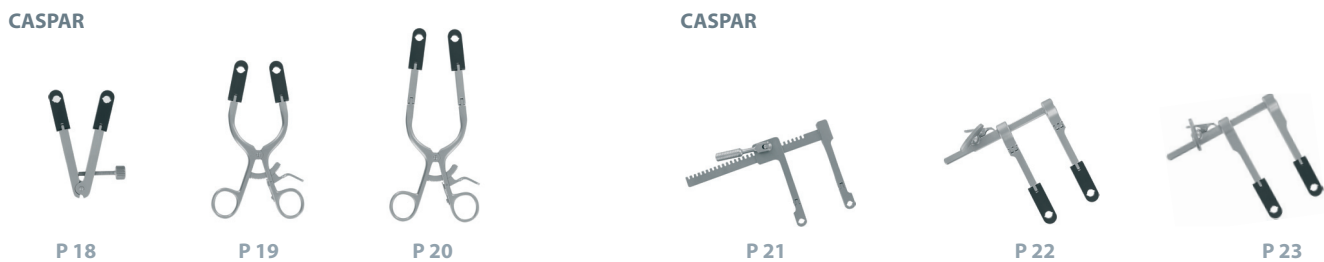

## Contre écarteurs - Counter retractors

CASPAR



P 30



P 31

## Écarteurs - Retractors

CASPAR



P 32



P 33

Titane



P 34

Titane

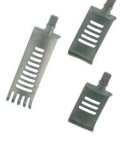

P 35

## Distracteurs - Distractors

CASPAR



P 36



P 37



Mèche  
Drill

Broche  
Pins

P 38

## Greffe Osseuse - Bone graft



P 39



P 39



P 40



P 40

## Écarteurs - Retractors

## Contre écarteurs - Counter retractors

CASPAR



P 42



P 42



P 43



P 43



P 43

### WEITLANER



Pointu Sharp	Mousse Blunt	Semi-pointu Semi-sharp
-----------------	-----------------	---------------------------

10,5 cm - 4 1/4 "	<b>B80525</b>	<b>B805251</b>	<b>B805252</b>
13 cm - 5 1/4 "	<b>B80530</b>	<b>B805301</b>	<b>B805302</b>

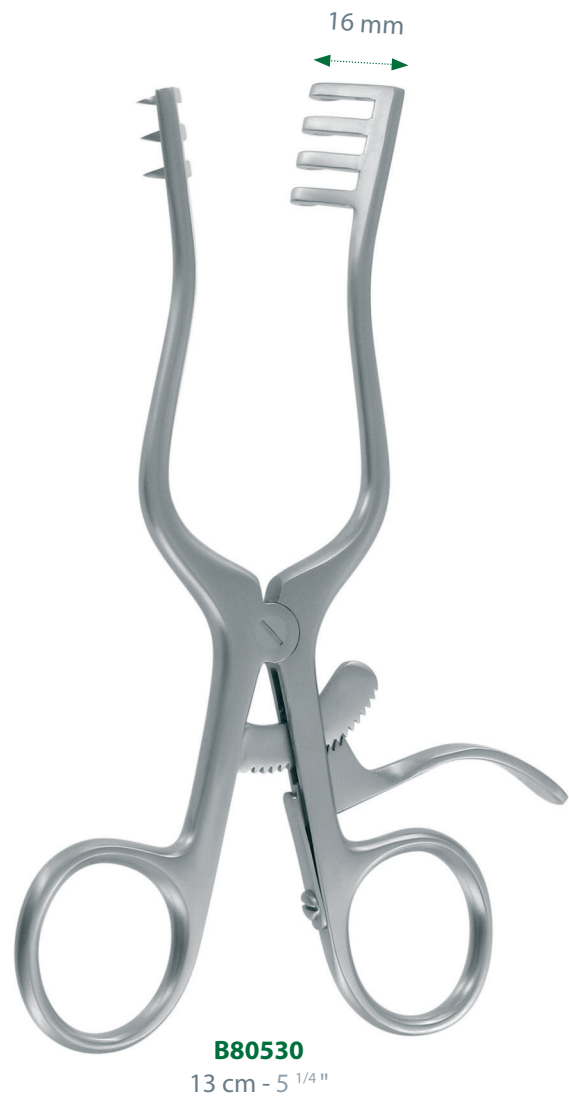
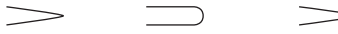

IV - Écarteurs  
IV - Retractors

WEITLANER



Pointu Sharp      Mousse Blunt      Semi-pointu Semi-sharp

17 cm - 6 3/4 "

**B80535**

**B805351**

**B805352**

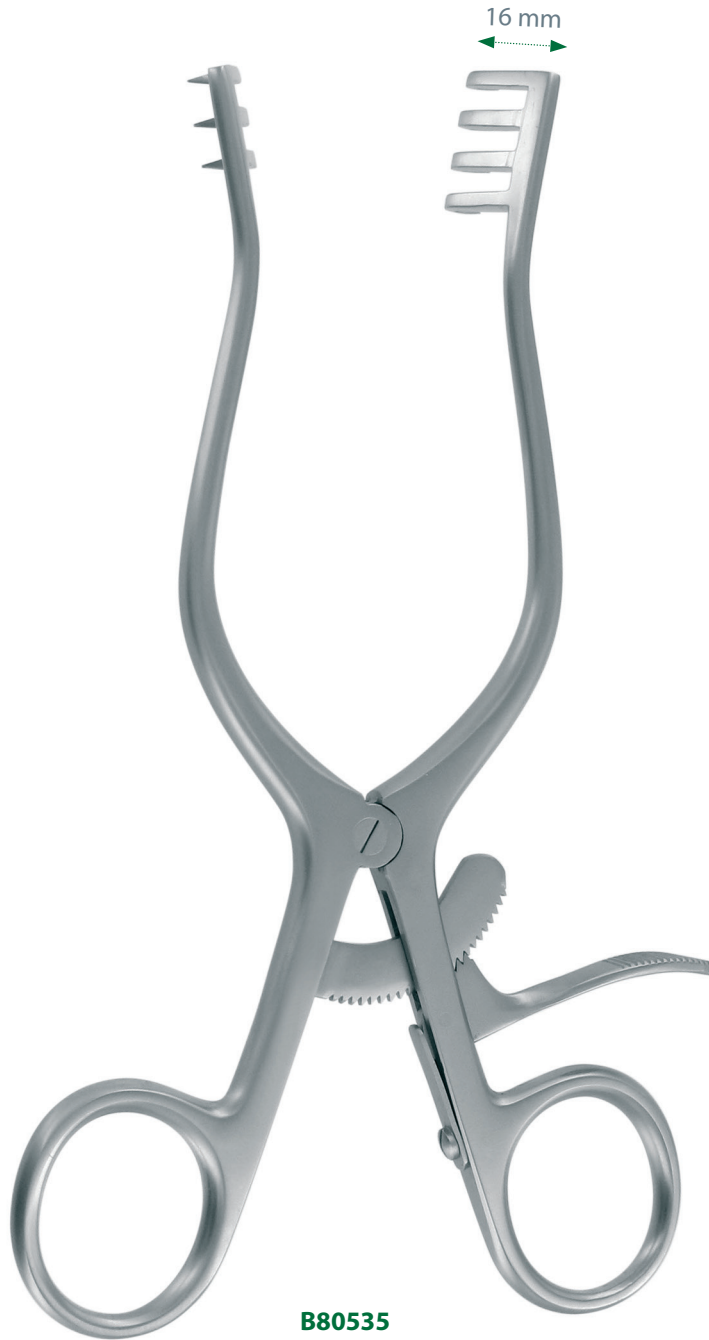

**B80535**  
17 cm - 6 3/4 "

IV - Écarteurs  
IV - Retractors

### WEITLANER



Pointu  
Sharp

Mousse  
Blunt

20 cm - 8 "	<b>B80537</b>	<b>B805371</b>	3 x 4 griffes - teeth	20 mm
24 cm - 9 1/2 "	<b>B805360</b>	<b>B805361</b>	3 x 4 griffes - teeth	26 mm
25 cm - 9 3/4 "	<b>B805390</b>	<b>B805391</b>	5 x 6 griffes - teeth	27 mm



**B80537**  
20 cm - 8 "

WEITLANER

WEITLANER  
WULLSTEIN



Courbe (dos d'âne) - Curved (back ass)

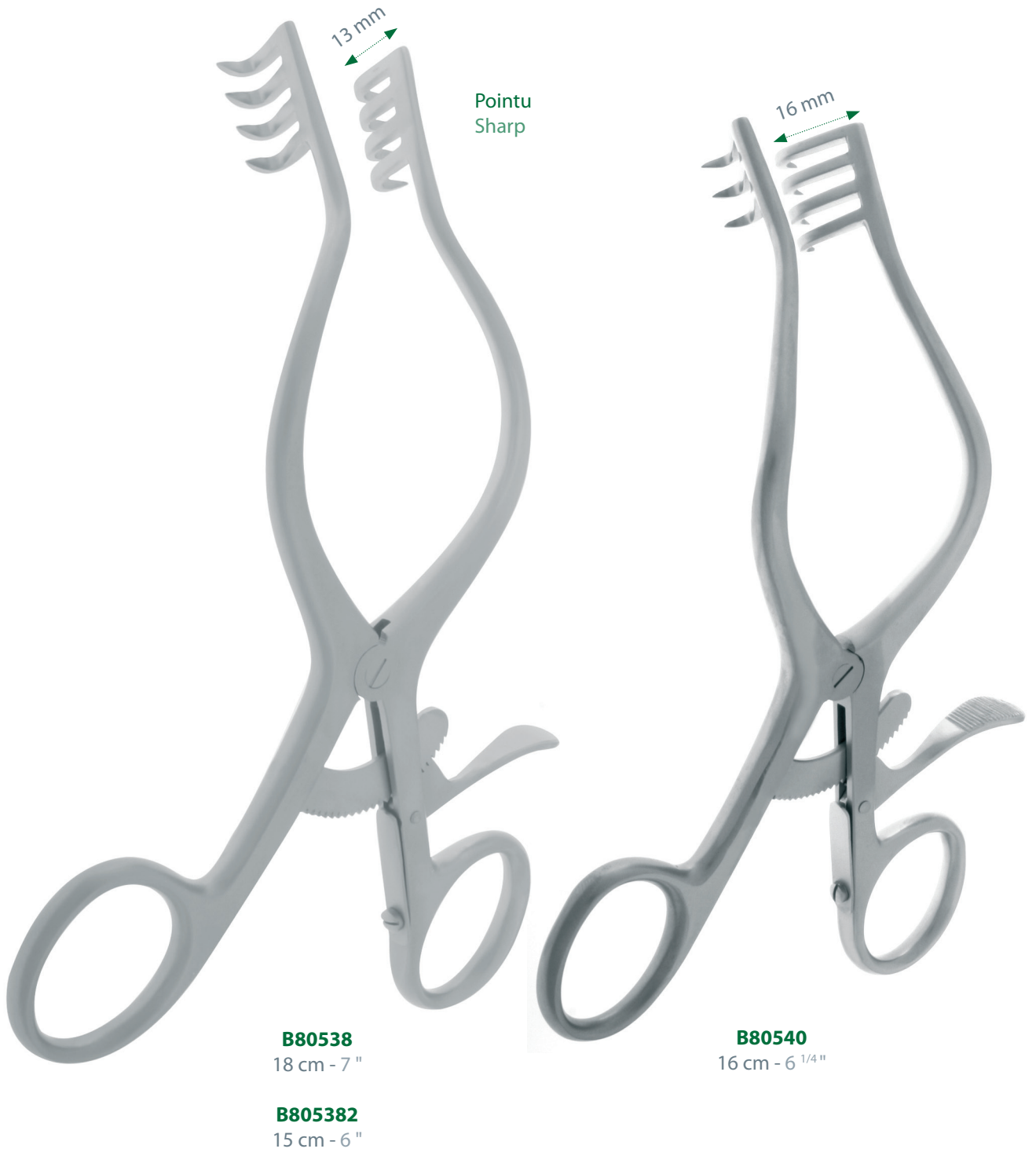

**B80538**  
18 cm - 7 "

**B805382**  
15 cm - 6 "

**B80540**  
16 cm - 6 1/4 "

IV - Écarteurs  
IV - Retractors

**WEITLANER  
NEURO**

Courbe (dos d'âne) - Curved (back ass)



BECKMANN CONE



IV - Écarteurs  
IV - Retractors



DEBAKEY

GELPY



- 10 cm - 4 " **B808551**
- 12 cm - 4 <sup>3</sup>/<sub>4</sub> " **B808552**
- 17 cm - 6 <sup>3</sup>/<sub>4</sub> " **B808553**

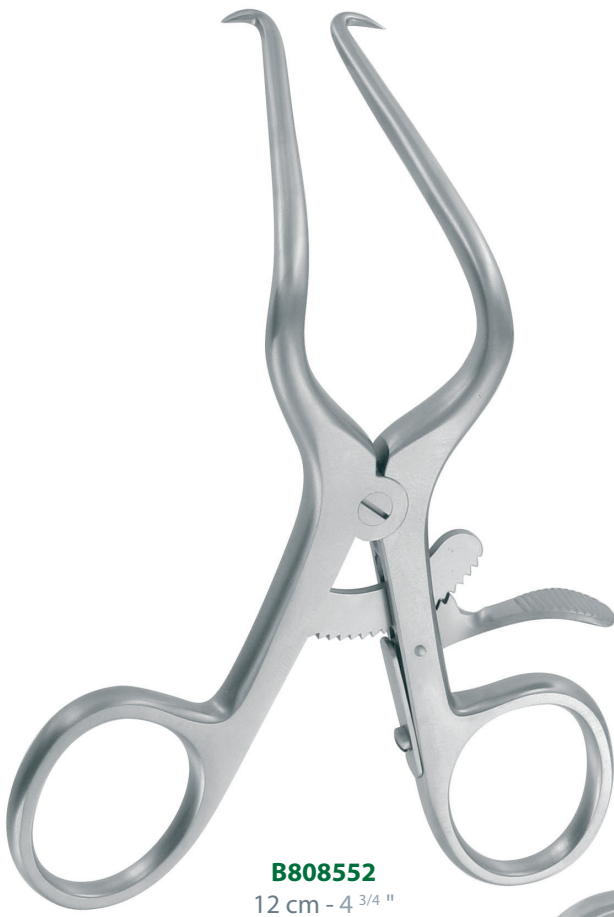

**B808552**  
12 cm - 4 <sup>3</sup>/<sub>4</sub> "



**B808555**  
19 cm - 7 <sup>1</sup>/<sub>2</sub> "

IV - Écarteurs  
IV - Retractors

MARKHAM-MEYERDING



Valve à gauche  
Blade on the left side  
50 x 26 mm

Valve à droite  
Blade on the right side  
50 x 26 mm

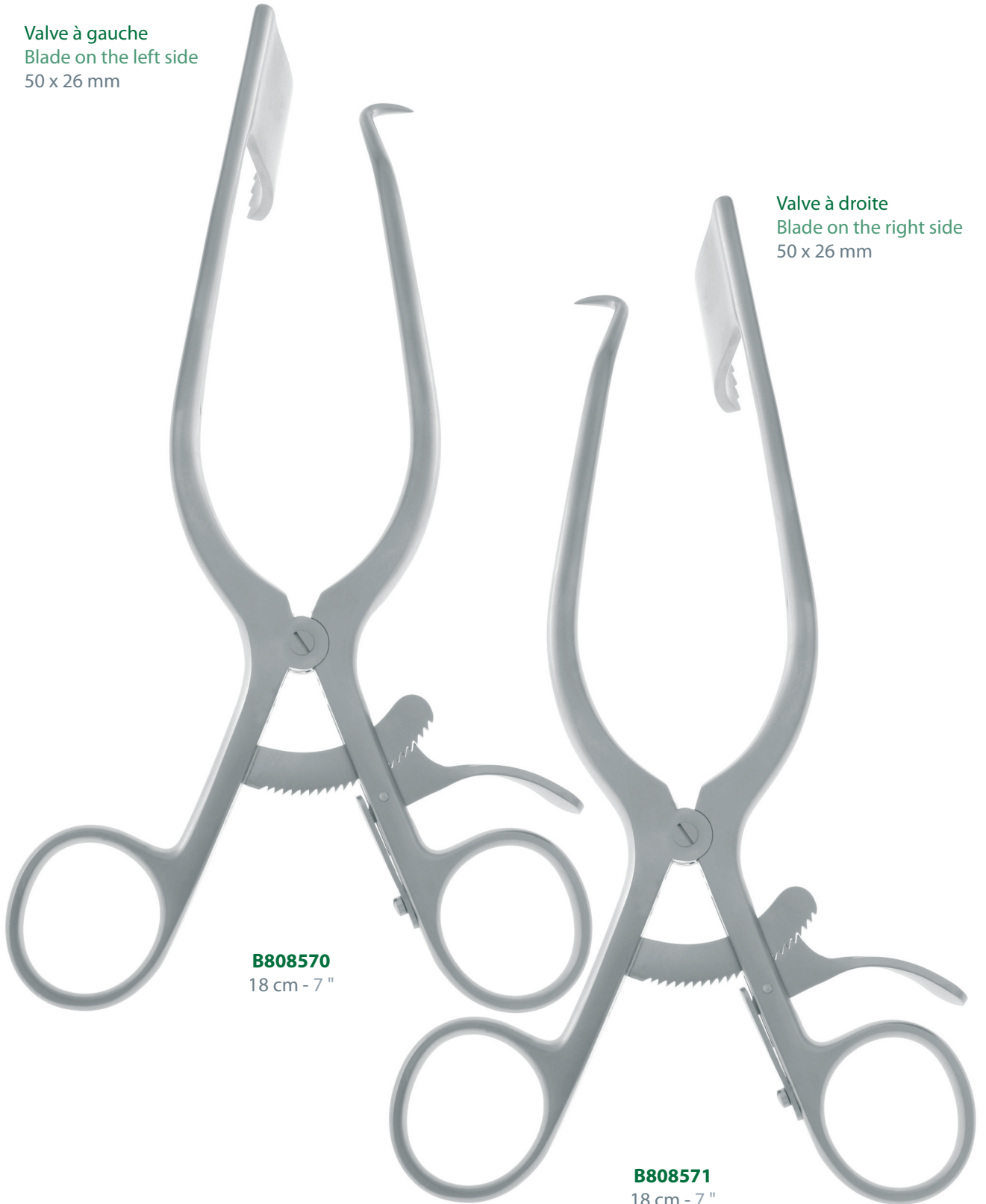

**B808570**  
18 cm - 7 "

**B808571**  
18 cm - 7 "

IV - Écarteurs  
IV - Retractors

WALTON



Pour hémilaminectomie - For hemilaminectomy

7 Griffes à gauche  
7 Teeth on the left side

35 mm

Pointu  
Sharp

7 Griffes à droite  
7 Teeth on the right side

35 mm

Pointu  
Sharp



**B80860**  
20 cm - 8 "



**B80865**  
20 cm - 8 "

### ADSON

#### B80870

2 x 6 griffes 32 mm  
2 x 6 teeth 32 mm

#### B80874

6 griffes courtes 13 mm à gauche  
6 short teeth 13 mm on the left side

#### B80878

6 griffes courtes 13 mm à droite  
6 short teeth 13 mm on the right side



NORFOLK-NORWICH



BECKMANN-ADSON

BECKMANN-EATON



Pointu Sharp      Mousse Blunt      Semi-pointu Semi-sharp

31 cm - 12 1/4"      **B808660**      **B808661**      **B808662**



13 mm

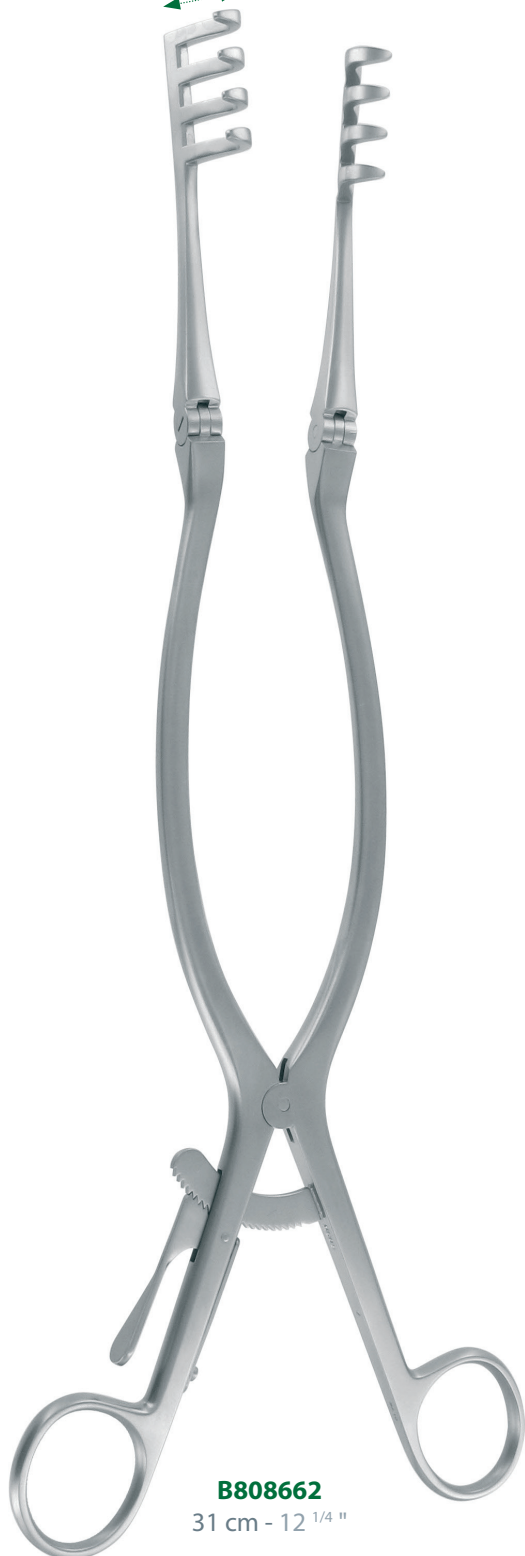

**B808662**  
31 cm - 12 1/4"

50 mm

Pointu Sharp



**B808580**  
33 cm - 13"

IV - Écarteurs  
IV - Retractors

INGE-MEHARY



Écartement 38 mm  
Blades opening 38 mm

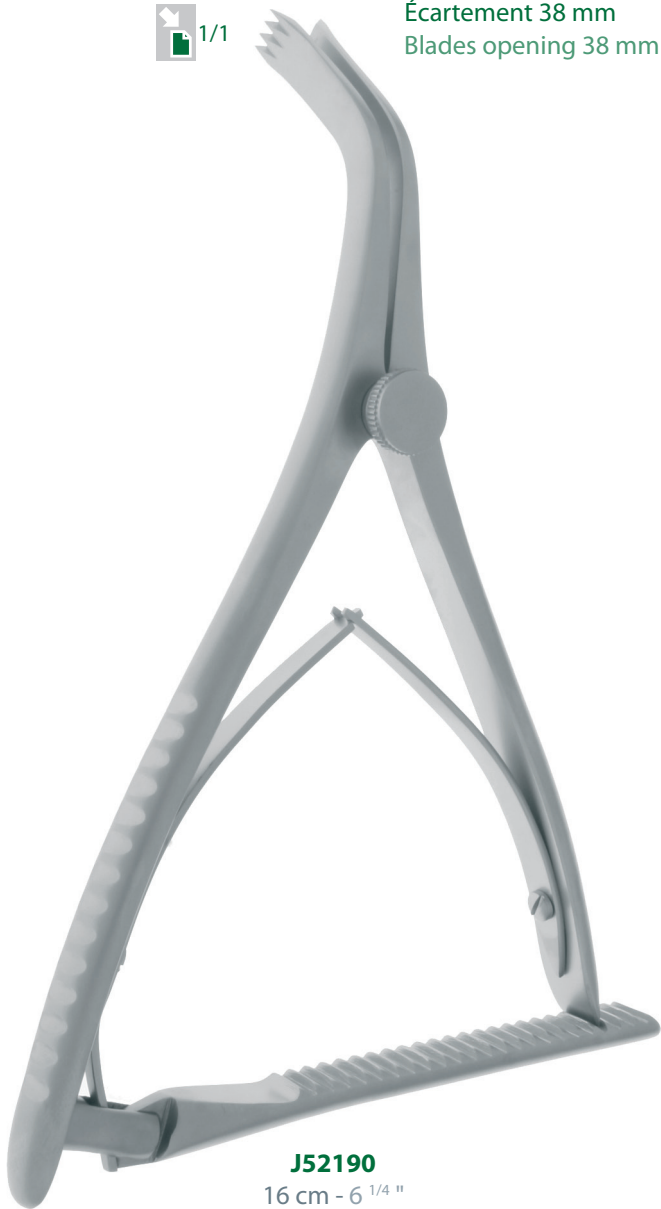

**J52190**  
16 cm - 6 1/4 "

Écartement 50 mm  
Blades opening 50 mm

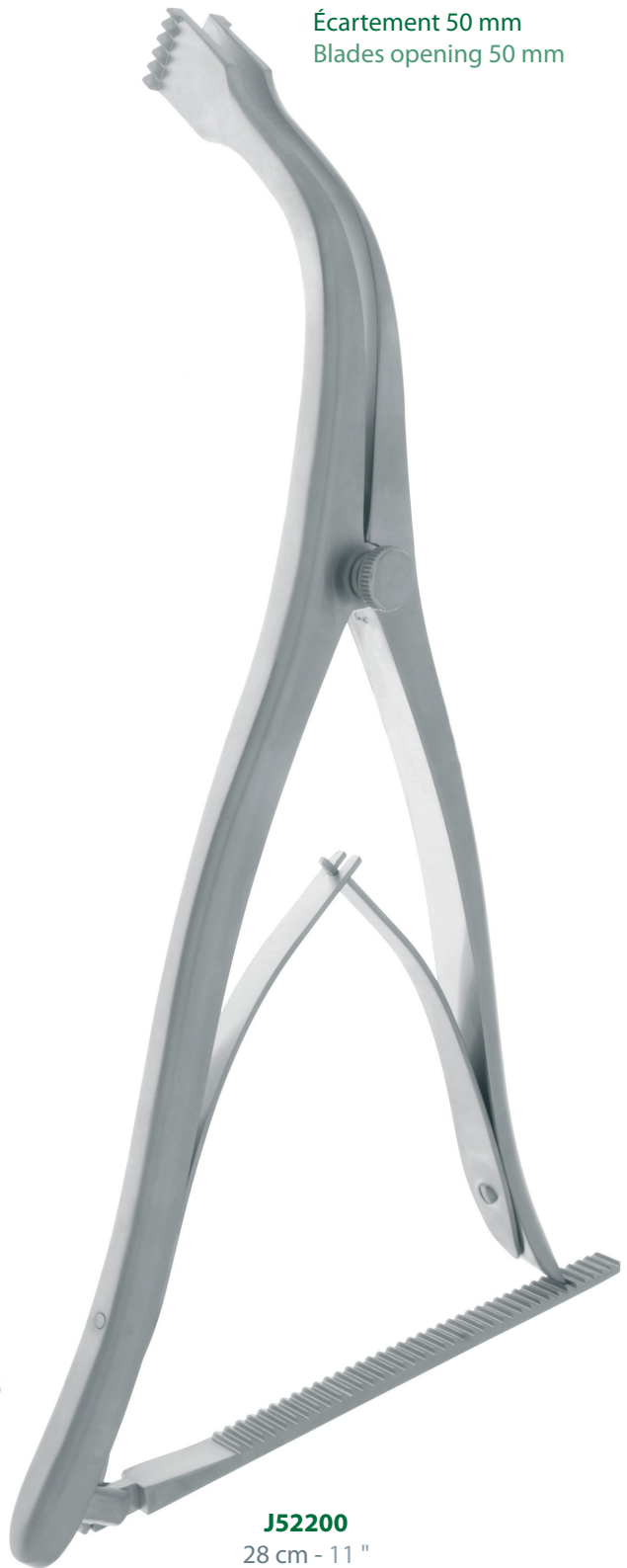

**J52200**  
28 cm - 11 "

CLOWARD



Écartement 15 mm  
Blades opening 15 mm



**J52205**  
16 cm - 6 1/4 "



CLOWARD

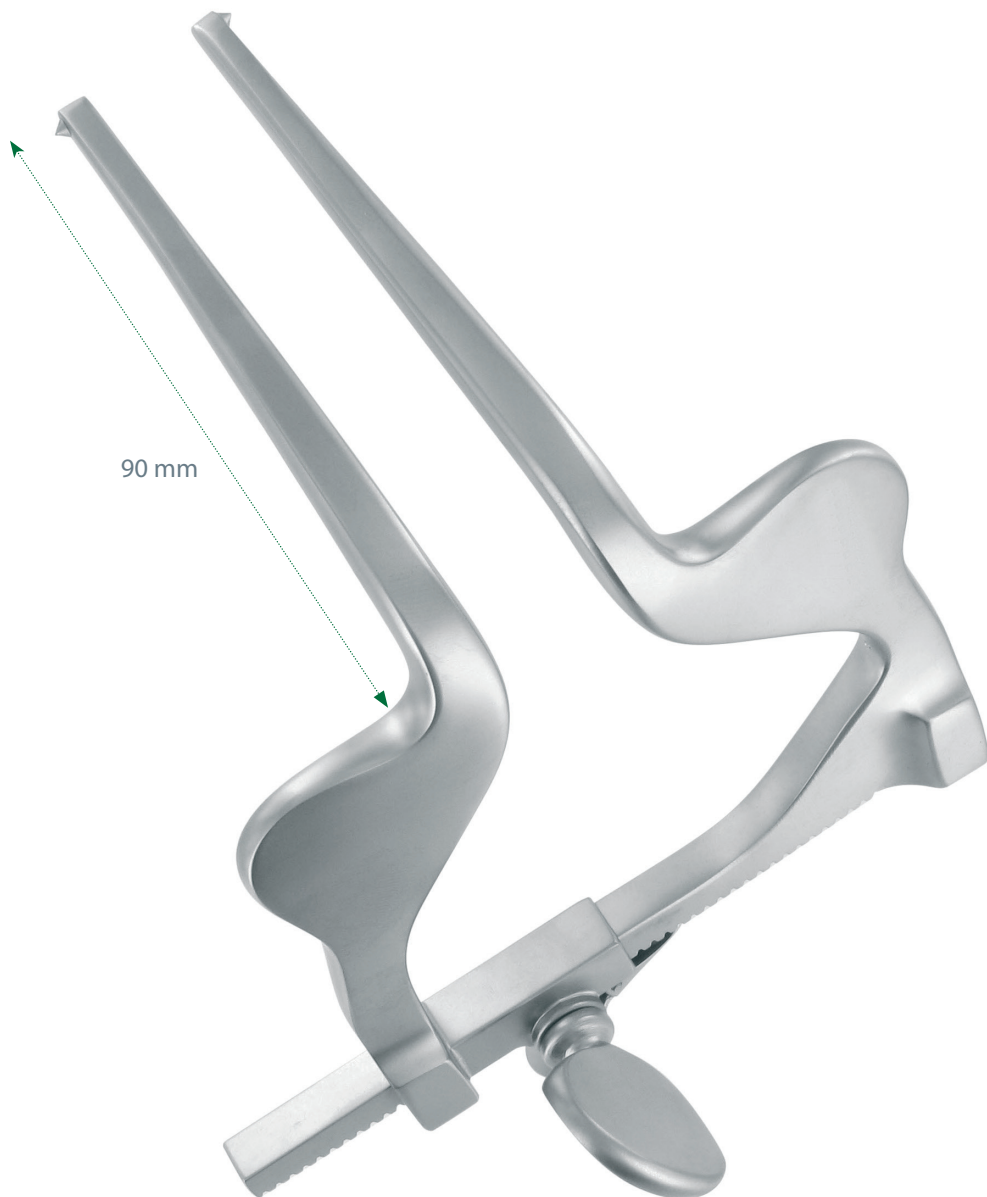

90 mm

**J538209**

9 cm - 3 1/2 "

**J538211**

11 cm - 4 1/4 "

IV - Écarteurs  
IV - Retractors

## Écarteurs - Retractors



### CLOWARD

Écarteur seul  
Retractor only



**J538110**  
25 cm - 10"



**J538010**  
15 cm - 6"

A griffes  
With teeth

Valves seules  
Blades only

Mousse  
Blunt

**J538040**

15 x 40 mm

**J538140**

**J538045**

15 x 45 mm

**J538145**

**J538050**

15 x 50 mm

**J538150**

**J538055**

15 x 55 mm

**J538155**

**J538060**

15 x 60 mm

**J538160**



**J538050**



**J538150**

### SCOVILLE-RICHTER

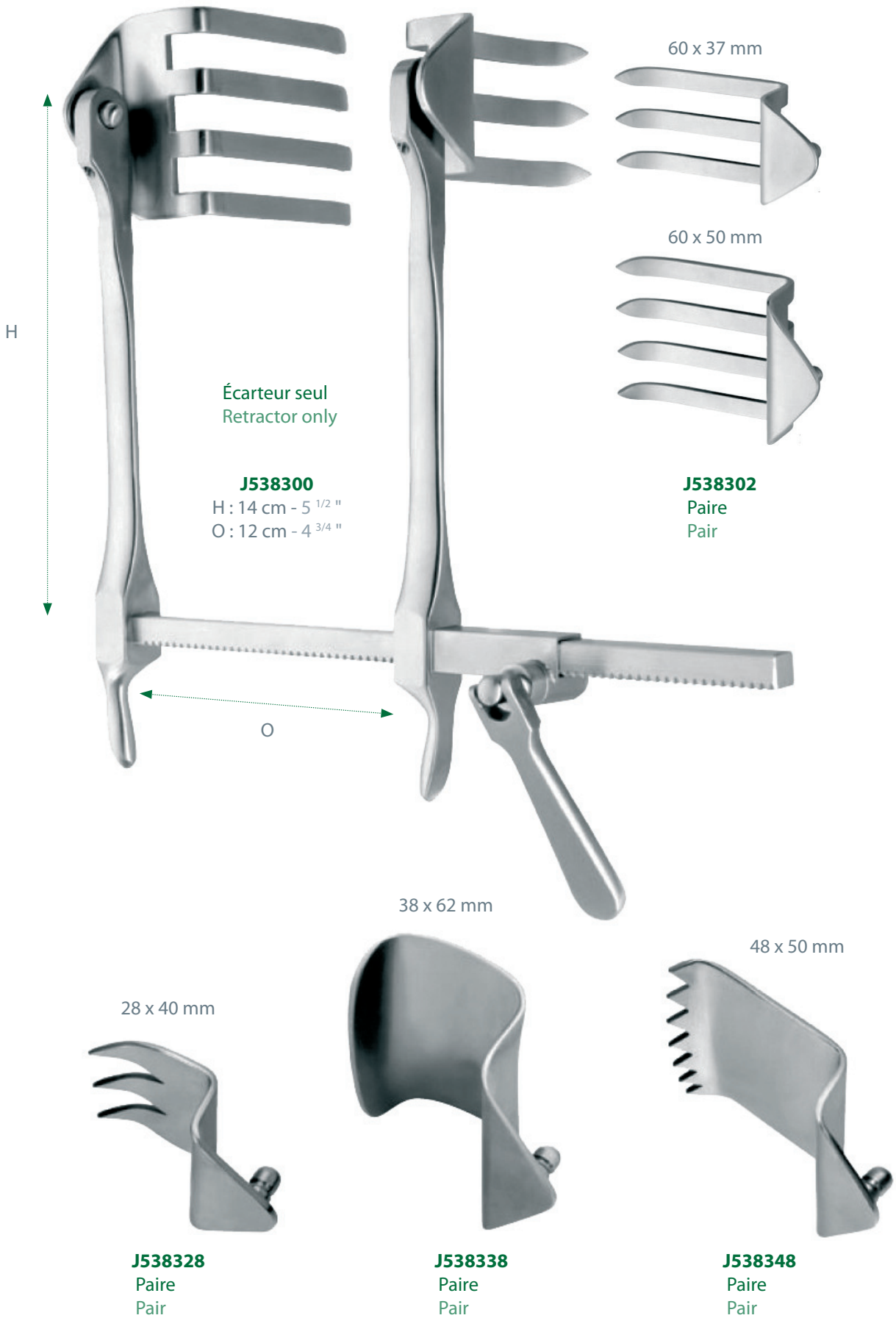

### CASPAR



Contre écarteur cervical  
Cervical counter retractor

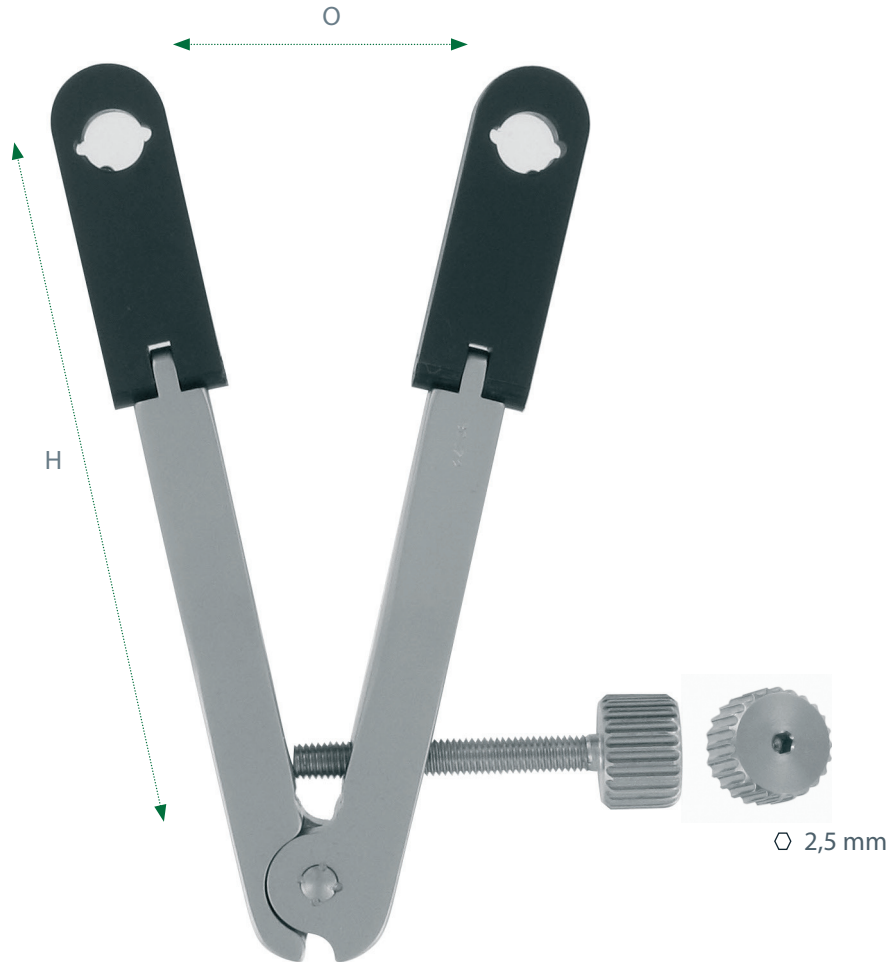

**J5385021**  
12 cm - 4 <sup>3</sup>/<sub>4</sub> "

Valves pages : 24 à 29.  
Blades pages : 24 to 29.

**J538502**  
Inox - Stainless steel  
H : 9 cm - 3 <sup>1</sup>/<sub>2</sub> " - O : 7 cm - 2 <sup>3</sup>/<sub>4</sub> "

**J5385021**  
Bras en peek - Peek arms  
H : 9 cm - 3 <sup>1</sup>/<sub>2</sub> " - O : 7 cm - 2 <sup>3</sup>/<sub>4</sub> "

### CASPAR



Contre écarteur cervical  
Cervical counter retractor

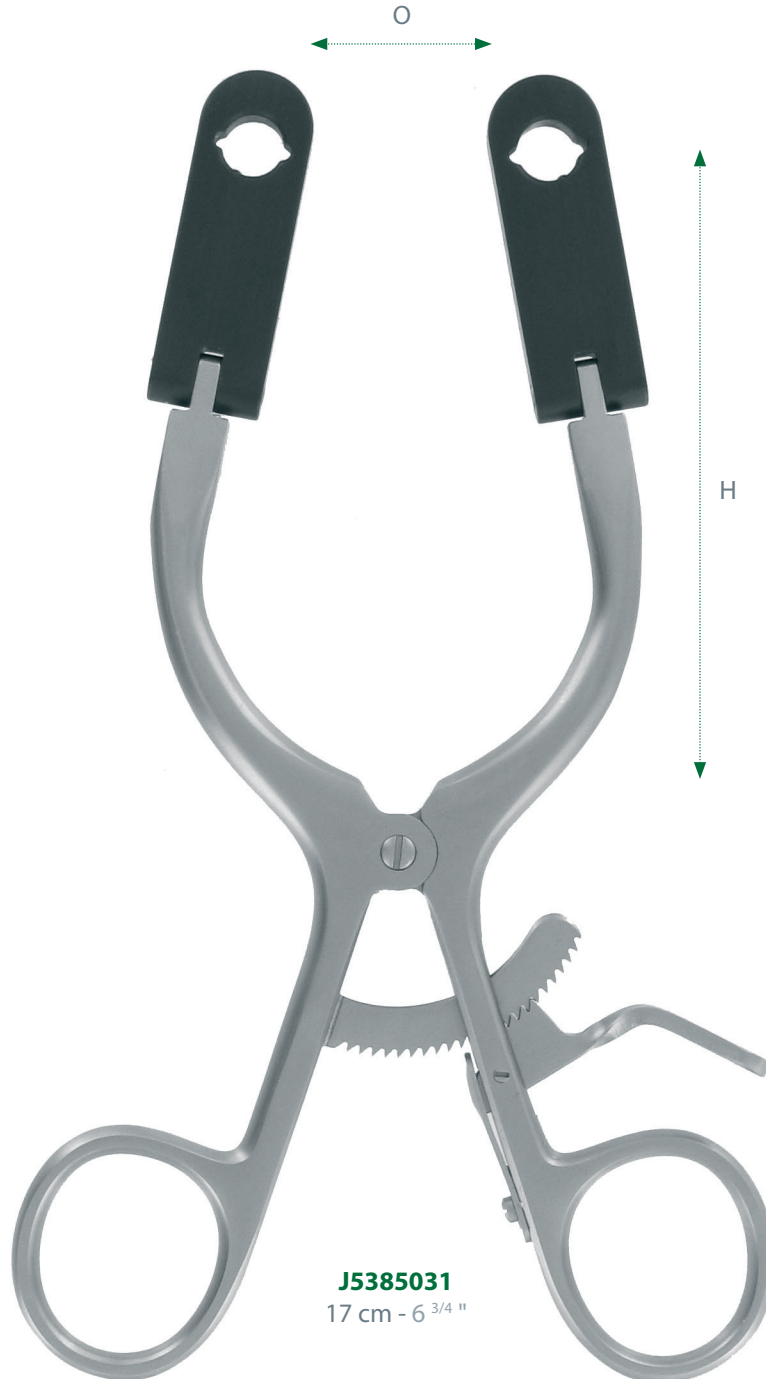

Valves pages : 24 à 29.  
Blades pages : 24 to 29.

**J538503**  
Inox - Stainless steel  
H : 8,5 cm - 3 1/4 " - O : 8,5 cm - 3 1/4 "

**J5385031**  
Bras en peek - Peek arms  
H : 8,5 cm - 3 1/4 " - O : 7 cm - 2 3/4 "

Écarteurs - Retractors



CASPAR

Contre écarteur cervical  
Cervical counter retractor



Valves pages : 24 à 29.  
Blades pages : 24 to 29.

**J5385041**  
21 cm - 8 1/4 "

**J538504**  
Inox - Stainless steel  
H : 12 cm - 4 3/4 " - O : 8,5 cm - 3 1/4 "

**J5385041**  
Bras en peek - Peek arms  
H : 12 cm - 4 3/4 " - O : 8,5 cm - 3 1/4 "

### CASPAR

Écarteur cervical  
Cervical retractor

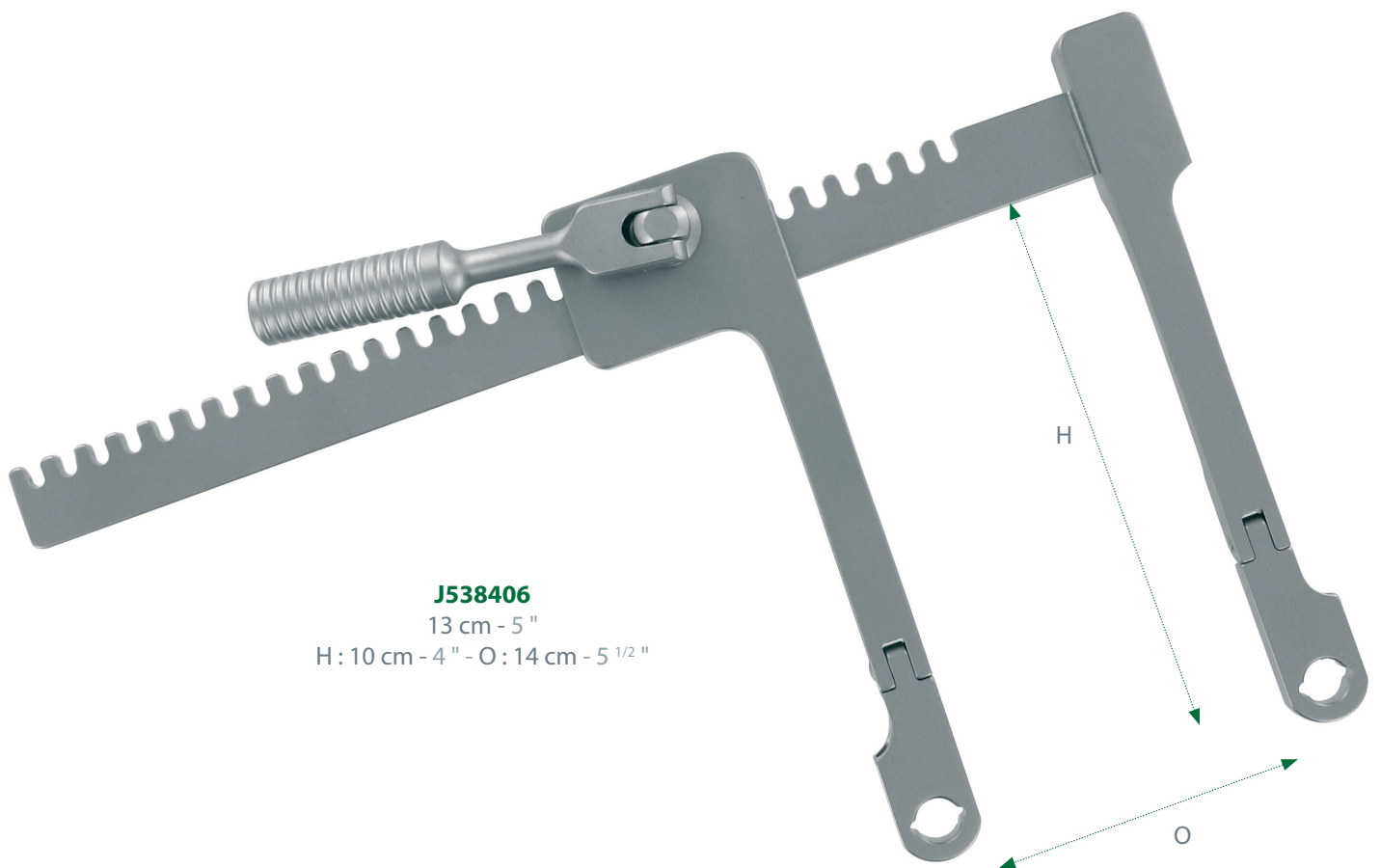

**J538406**  
13 cm - 5 "  
H : 10 cm - 4 " - O : 14 cm - 5 1/2 "

IV - Écarteurs  
IV - Retractors

Valves pages : 24 à 29.  
Blades pages : 24 to 29.

CASPAR



Écarteur cervical  
Cervical retractor

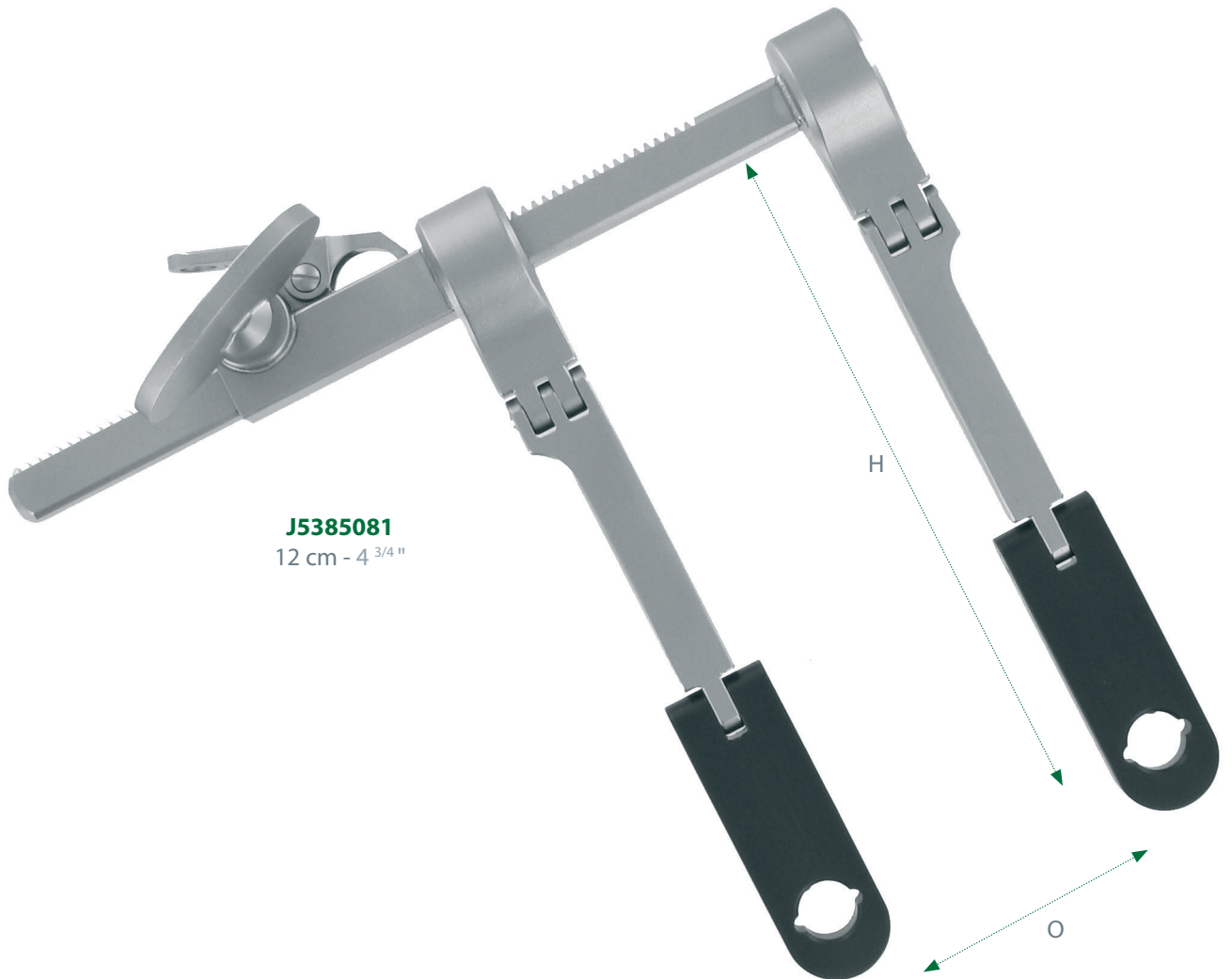

**J5385081**  
12 cm - 4 3/4 "

Valves pages : 24 à 29.  
Blades pages : 24 to 29.

**J538508**  
Inox - Stainless steel  
H : 10 cm - 4 " - O : 7 cm - 2 3/4 "

**J5385081**  
Bras en peek - Peek arms  
H : 10 cm - 4 " - O : 7 cm - 2 3/4 "



### CASPAR



Écarteur cervical  
Cervical retractor

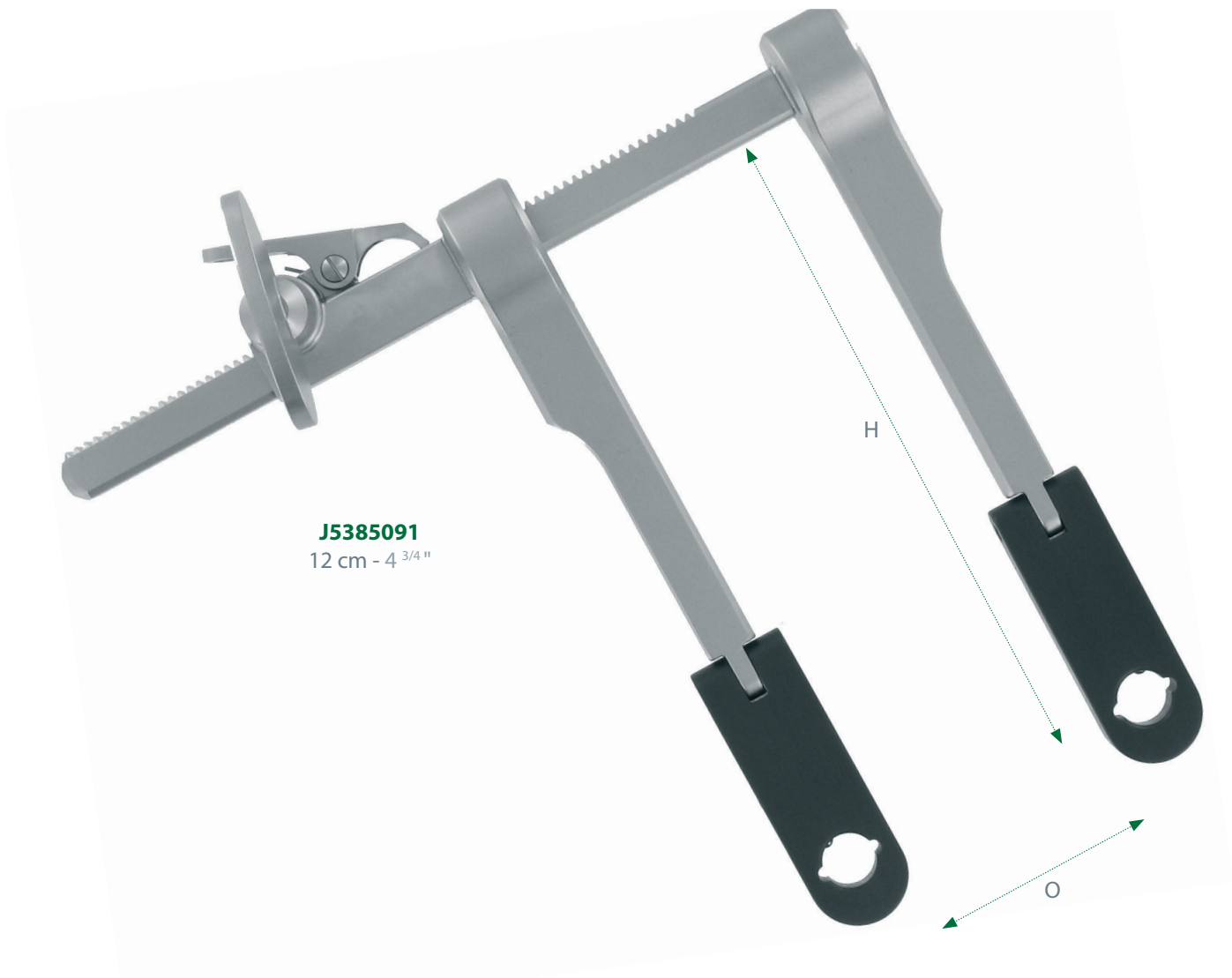

**J5385091**  
12 cm - 4 <sup>3</sup>/<sub>4</sub> "

IV - Écarteurs  
IV - Retractors

Valves pages : 24 à 29.  
Blades pages : 24 to 29.

**J538509**  
Inox - Stainless steel  
H : 10 cm - 4 " - O : 7 cm - 2 <sup>3</sup>/<sub>4</sub> "

**J5385091**  
Bras en peek - Peek arms  
H : 10 cm - 4 " - O : 7 cm - 2 <sup>3</sup>/<sub>4</sub> "

**J5385092**  
Inox - Stainless steel  
H : 10 cm - 4 " - O : 12 cm - 4 <sup>3</sup>/<sub>4</sub> "

## Écarteurs - Retractors

### CASPAR



Valves seules - Blades only  
Inox - Stainless steel

2 Griffes  
2 Teeth



**J538413**

32 x 22 mm	<b>J538410</b>
37 x 22 mm	<b>J538411</b>
42 x 22 mm	<b>J538412</b>
47 x 22 mm	<b>J538413</b>
52 x 22 mm	<b>J538414</b>
57 x 22 mm	<b>J538415</b>
62 x 22 mm	<b>J538416</b>
67 x 22 mm	<b>J538417</b>

3 Griffes  
3 Teeth



**J538423**

32 x 37 mm	<b>J538420</b>
37 x 37 mm	<b>J538421</b>
42 x 37 mm	<b>J538422</b>
47 x 37 mm	<b>J538423</b>
52 x 37 mm	<b>J538424</b>
57 x 37 mm	<b>J538425</b>
62 x 37 mm	<b>J538426</b>
67 x 37 mm	<b>J538427</b>

4 Griffes  
4 Teeth



**J538433**

32 x 52 mm	<b>J538430</b>
37 x 52 mm	<b>J538431</b>
42 x 52 mm	<b>J538432</b>
47 x 52 mm	<b>J538433</b>
52 x 52 mm	<b>J538434</b>
57 x 52 mm	<b>J538435</b>
62 x 52 mm	<b>J538436</b>
67 x 52 mm	<b>J538437</b>

Crochets  
Hooks



**J538441**

38 mm	<b>J538440</b>
58 mm	<b>J538441</b>

### CASPAR

Valves seules - Blades only  
Inox - Stainless steel



Latérale  
Lateral



**J538542**

40 x 15 mm	<b>J538540</b>
45 x 15 mm	<b>J538541</b>
50 x 15 mm	<b>J538542</b>
55 x 15 mm	<b>J538543</b>
60 x 15 mm	<b>J538544</b>

Latérale  
Lateral



**J538522**

40 x 23 mm	<b>J538520</b>
45 x 23 mm	<b>J538521</b>
50 x 23 mm	<b>J538522</b>
55 x 23 mm	<b>J538523</b>
60 x 23 mm	<b>J538524</b>
65 x 23 mm	<b>J538525</b>
70 x 23 mm	<b>J538526</b>

IV - Écarteurs  
IV - Retractors

Pince pour changer les valves  
Forceps for changing the blades



**J538901**  
11,5 cm - 4 1/2"

## Écarteurs - Retractors

### CASPAR

Valves seules - Blades only  
Inox - Stainless steel



Médiane  
Medial



**J538512**

Mousse  
Blunt



**J538531**

Cervicale  
Cervical



**J538537**

35 x 23 mm	<b>J5385095</b>
40 x 23 mm	<b>J538510</b>
45 x 23 mm	<b>J538511</b>
50 x 23 mm	<b>J538512</b>
55 x 23 mm	<b>J538513</b>
60 x 23 mm	<b>J538514</b>
65 x 23 mm	<b>J538515</b>
70 x 23 mm	<b>J538516</b>

35 x 23 mm	<b>J538528</b>
40 x 23 mm	<b>J538529</b>
45 x 23 mm	<b>J538530</b>
50 x 23 mm	<b>J538531</b>
55 x 23 mm	<b>J538532</b>
60 x 23 mm	<b>J538533</b>
65 x 23 mm	<b>J538534</b>
70 x 23 mm	<b>J538535</b>
75 x 23 mm	<b>J538536</b>

50 x 25 mm	<b>J538537</b>
60 x 25 mm	<b>J538538</b>

Pince pour changer les valves  
Forceps for changing the blades



**J538901**  
11,5 cm - 4 1/2"

## Écarteurs - Retractors

### CASPAR

Valves seules - Blades only  
Peek - Peek



Médiane  
Medial



J538512P

Latérale  
Lateral



J538522P

Mousse  
Blunt



J538531P

40 x 23 mm

J538510P

40 x 23 mm

J538520P

40 x 23 mm

J538529P

45 x 23 mm

J538511P

45 x 23 mm

J538521P

45 x 23 mm

J538530P

50 x 23 mm

J538512P

50 x 23 mm

J538522P

50 x 23 mm

J538531P

55 x 23 mm

J538513P

55 x 23 mm

J538523P

55 x 23 mm

J538532P

60 x 23 mm

J538514P

60 x 23 mm

J538524P

60 x 23 mm

J538533P

65 x 23 mm

J538515P

65 x 23 mm

J538525P

65 x 23 mm

J538534P

75 x 23 mm

J538517P

75 x 23 mm

J538527P

75 x 23 mm

J538536P

Pince pour changer les valves  
Forceps for changing the blades



J538901  
11,5 cm - 4 1/2"

### CASPAR



Valves seules - Blades only  
Titane - Titanium

Médiane  
Medial



**J538512T**

Latérale  
Lateral



**J538522T**

Mousse  
Blunt



**J538614T**

40 x 20 mm	<b>J538510T</b>
45 x 20 mm	<b>J538511T</b>
50 x 20 mm	<b>J538512T</b>
55 x 20 mm	<b>J538513T</b>
60 x 20 mm	<b>J538514T</b>
65 x 20 mm	<b>J538515T</b>
70 x 20 mm	<b>J538516T</b>
75 x 20 mm	<b>J538517T</b>

30 x 20 mm	<b>J538518T</b>
35 x 20 mm	<b>J538519T</b>
40 x 20 mm	<b>J538520T</b>
45 x 20 mm	<b>J538521T</b>
50 x 20 mm	<b>J538522T</b>
55 x 20 mm	<b>J538523T</b>
60 x 20 mm	<b>J538524T</b>
65 x 20 mm	<b>J538525T</b>
70 x 20 mm	<b>J538526T</b>
75 x 20 mm	<b>J538527T</b>

30 x 20 mm	<b>J538610T</b>
35 x 20 mm	<b>J538611T</b>
40 x 20 mm	<b>J538612T</b>
45 x 20 mm	<b>J538613T</b>
50 x 20 mm	<b>J538614T</b>
55 x 20 mm	<b>J538615T</b>
60 x 20 mm	<b>J538616T</b>
65 x 20 mm	<b>J538617T</b>
70 x 20 mm	<b>J538618T</b>
75 x 20 mm	<b>J538619T</b>

Pince pour changer les valves  
Forceps for changing the blades



**J538901**  
11,5 cm - 4 1/2"

### CASPAR



Valves fenêtrées seules - Fenestrated blades only  
Titane - Titanium

Médiane  
Medial



**J538514TF**

Latérale  
Lateral



**J538522TF**

Mousse  
Blunt



**J538614TF**

35 x 20 mm	<b>J5385095TF</b>
40 x 20 mm	<b>J538510TF</b>
45 x 20 mm	<b>J538511TF</b>
50 x 20 mm	<b>J538512TF</b>
55 x 20 mm	<b>J538513TF</b>
60 x 20 mm	<b>J538514TF</b>
65 x 20 mm	<b>J538515TF</b>
70 x 20 mm	<b>J538516TF</b>

30 x 20 mm	<b>J538518TF</b>
35 x 20 mm	<b>J538519TF</b>
40 x 20 mm	<b>J538520TF</b>
45 x 20 mm	<b>J538521TF</b>
50 x 20 mm	<b>J538522TF</b>
55 x 20 mm	<b>J538523TF</b>
60 x 20 mm	<b>J538524TF</b>
65 x 20 mm	<b>J538525TF</b>
70 x 20 mm	<b>J538526TF</b>

35 x 20 mm	<b>J538611TF</b>
40 x 20 mm	<b>J538612TF</b>
45 x 20 mm	<b>J538613TF</b>
50 x 20 mm	<b>J538614TF</b>
55 x 20 mm	<b>J538615TF</b>
60 x 20 mm	<b>J538616TF</b>
65 x 20 mm	<b>J538617TF</b>
70 x 20 mm	<b>J538618TF</b>
75 x 20 mm	<b>J538619TF</b>

IV - Écarteurs  
IV - Retractors

Pince pour changer les valves  
Forceps for changing the blades



**J538901**  
11,5 cm - 4 1/2''

CASPAR



Contre écarteur cervical - Cervical counter retractor  
 Fixation rapide - Quick fixation

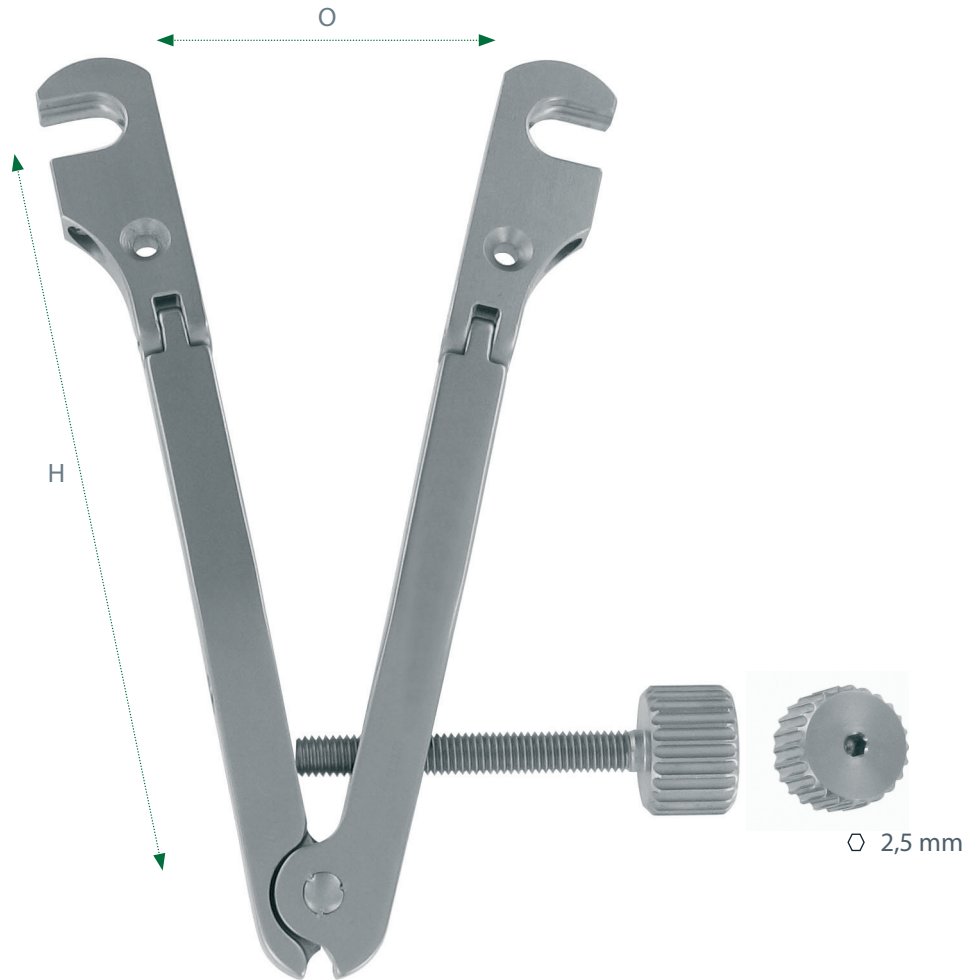

**J538702**

12 cm - 4 3/4 "

Inox - Stainless steel

H : 9,5 cm - 3 3/4 " - O : 7 cm - 2 3/4 "

Valves pages : 34, 35.  
 Blades pages : 34, 35.



CASPAR

Contre écarteur cervical - Cervical counter retractor  
Fixation rapide - Quick fixation

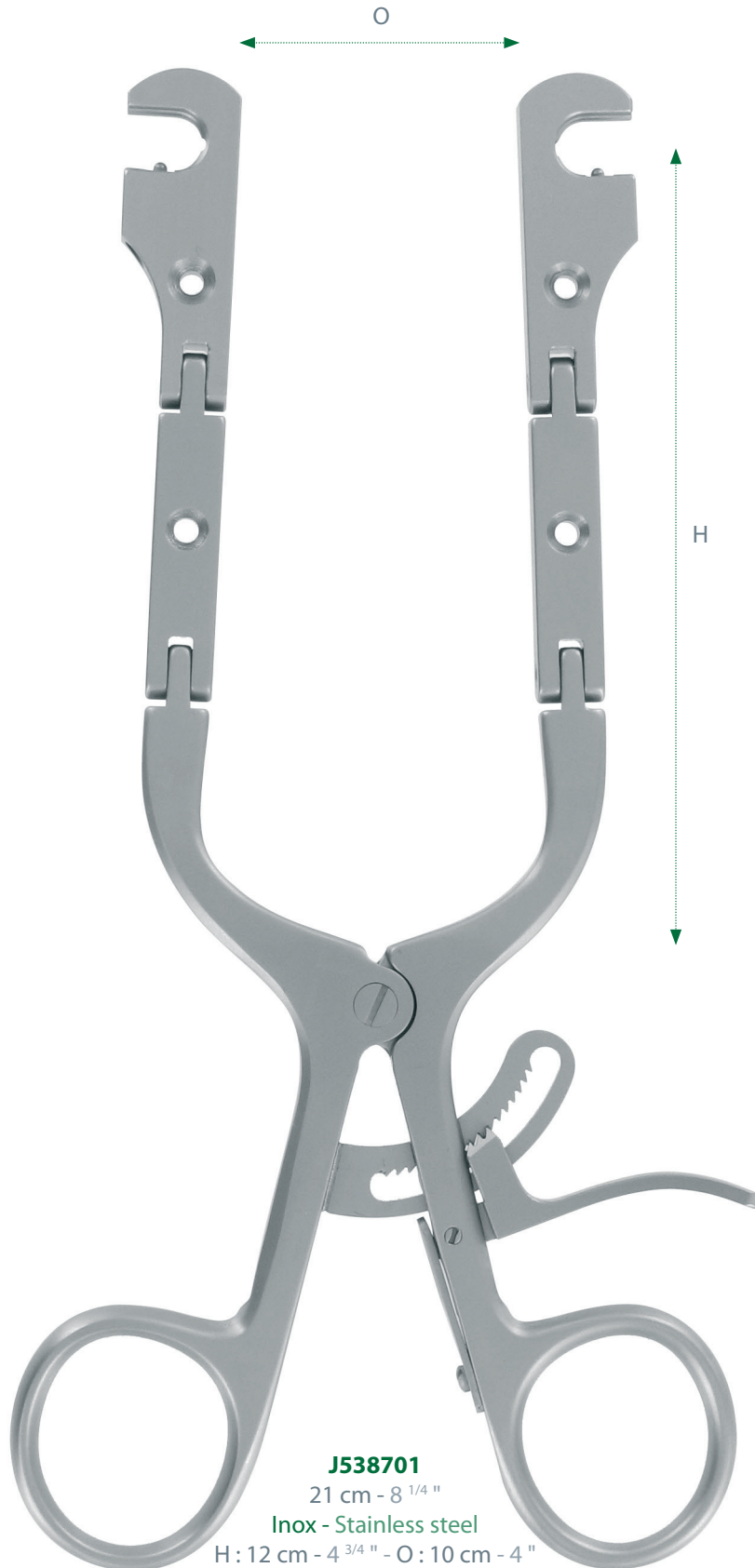

Valves pages : 34, 35.  
Blades pages : 34, 35.

**J538701**

21 cm - 8 1/4 "

Inox - Stainless steel

H : 12 cm - 4 3/4 " - O : 10 cm - 4 "

CASPAR



Écarteur cervical - Cervical retractor  
 Fixation rapide - Quick fixation

IV - Écarteurs  
 IV - Retractors

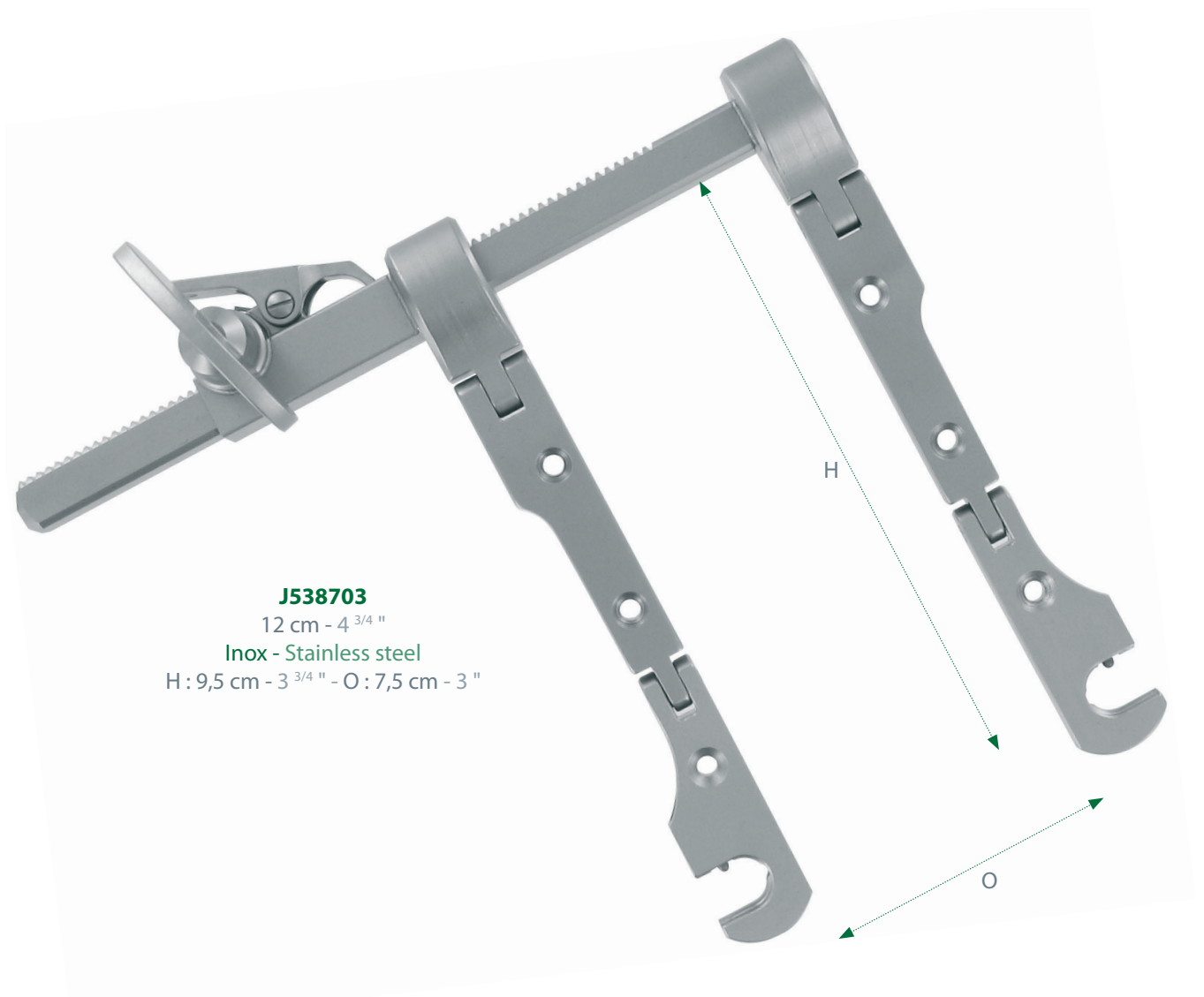

**J538703**  
 12 cm - 4 <sup>3</sup>/<sub>4</sub> ''  
 Inox - Stainless steel  
 H : 9,5 cm - 3 <sup>3</sup>/<sub>4</sub> '' - O : 7,5 cm - 3 ''

Valves pages : 34, 35.  
 Blades pages : 34, 35.

### CASPAR



Fixation rapide - Quick fixation



**J538705**

Manche pour valves - Handle for blades  
19 cm - 8 "

### CASPAR



Valves fenêtrées seules - Fenestrated blades only  
 Fixation rapide - Quick fixation  
 Titane - Titanium

Médiane / Latérale  
 Medial / Lateral



**J538710TF**

Mousse / Longitudinale  
 Blunt / Longitudinal



**J538720TF**

25 x 19 mm

**J538710TF**

30 x 19 mm

**J538711TF**

35 x 19 mm

**J538712TF**

40 x 19 mm

**J538713TF**

45 x 19 mm

**J538714TF**

50 x 19 mm

**J538715TF**

55 x 19 mm

**J538716TF**

60 x 19 mm

**J538717TF**

25 x 19 mm

**J538720TF**

30 x 19 mm

**J538721TF**

35 x 19 mm

**J538722TF**

40 x 19 mm

**J538723TF**

45 x 19 mm

**J538724TF**

50 x 19 mm

**J538725TF**

55 x 19 mm

**J538726TF**

60 x 19 mm

**J538727TF**



**J538705**  
 Manche pour valves  
 Handle for blades  
 19 cm - 8 "

### CASPAR



Valves fenêtrées seules - Fenestrated blades only  
 Fixation rapide - Quick fixation  
 Titane - Titanium

Médiane  
Medial



J538740TF

Latérale  
Lateral



J538730TF

Mousse / Longitudinale  
Blunt / Longitudinal



J538752TF

IV - Écarteurs  
IV - Retractors

30 x 24 mm

J538740TF

30 x 24 mm

J538730TF

35 x 24 mm

J538741TF

35 x 24 mm

J538731TF

35 x 24 mm

J538750TF

40 x 24 mm

J538742TF

40 x 24 mm

J538732TF

40 x 24 mm

J538751TF

45 x 24 mm

J538743TF

45 x 24 mm

J538733TF

45 x 24 mm

J538752TF

50 x 24 mm

J538744TF

50 x 24 mm

J538734TF

50 x 24 mm

J538753TF

55 x 24 mm

J538745TF

55 x 24 mm

J538735TF

55 x 24 mm

J538754TF

60 x 24 mm

J538746TF

60 x 24 mm

J538736TF

60 x 24 mm

J538755TF

65 x 24 mm

J538747TF

65 x 24 mm

J538737TF

65 x 24 mm

J538756TF

70 x 24 mm

J538748TF

70 x 24 mm

J538738TF

70 x 24 mm

J538757TF

75 x 24 mm

J538758TF



J538705

Manche pour valves  
Handle for blades  
19 cm - 8"

CASPAR

Distracteur cervical droit pour corps vertébraux  
Right cervical distractor for vertebral bodies

IV - Écarteurs  
IV - Retractors

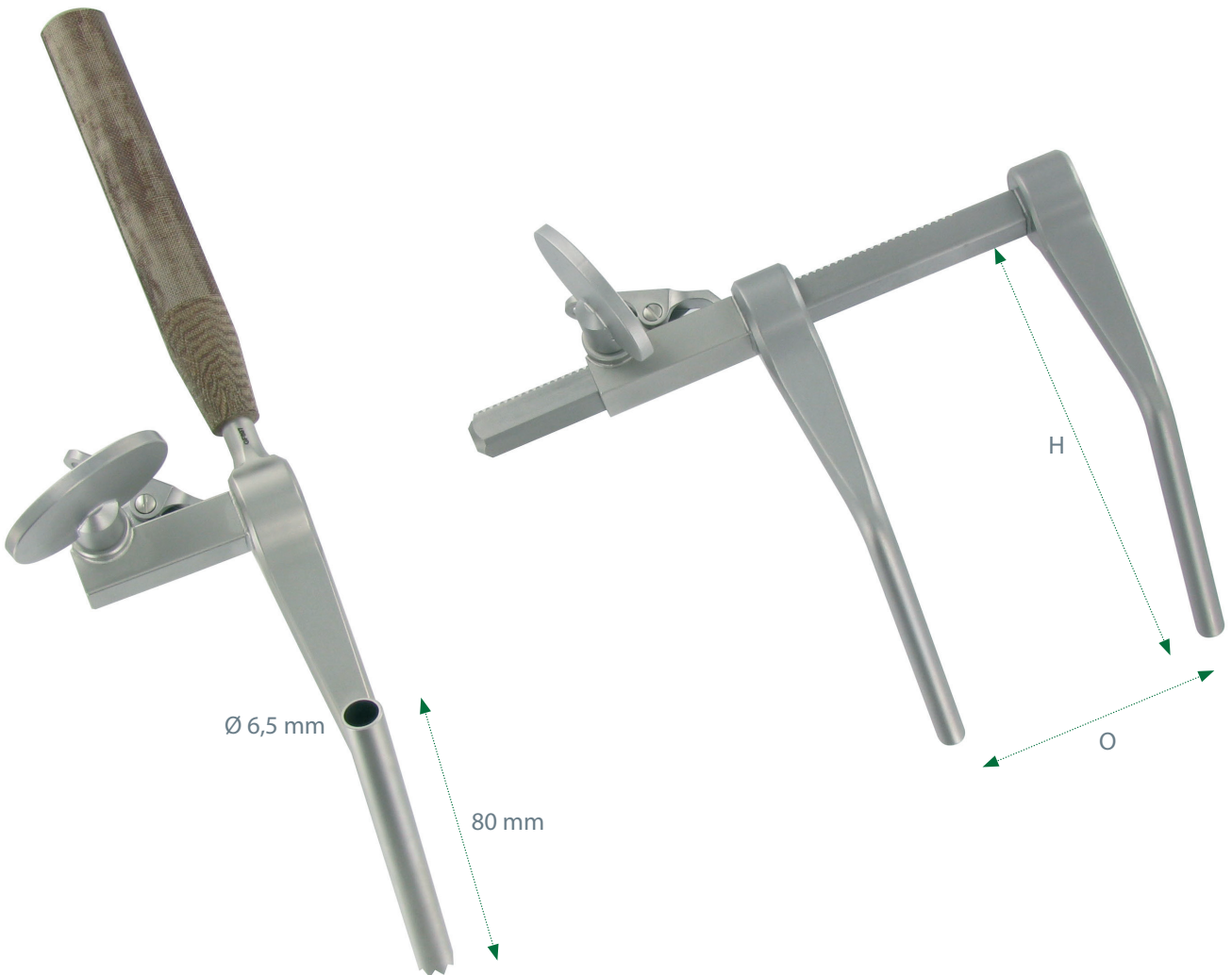

**J538804**  
21 cm - 9 "

**J538802**  
10 cm - 4 "  
H : 9 cm - 3 1/2 " - O : 8 cm - 3 "



### CASPAR

Distracteur cervical gauche pour corps vertébraux  
Left cervical distractor for vertebral bodies

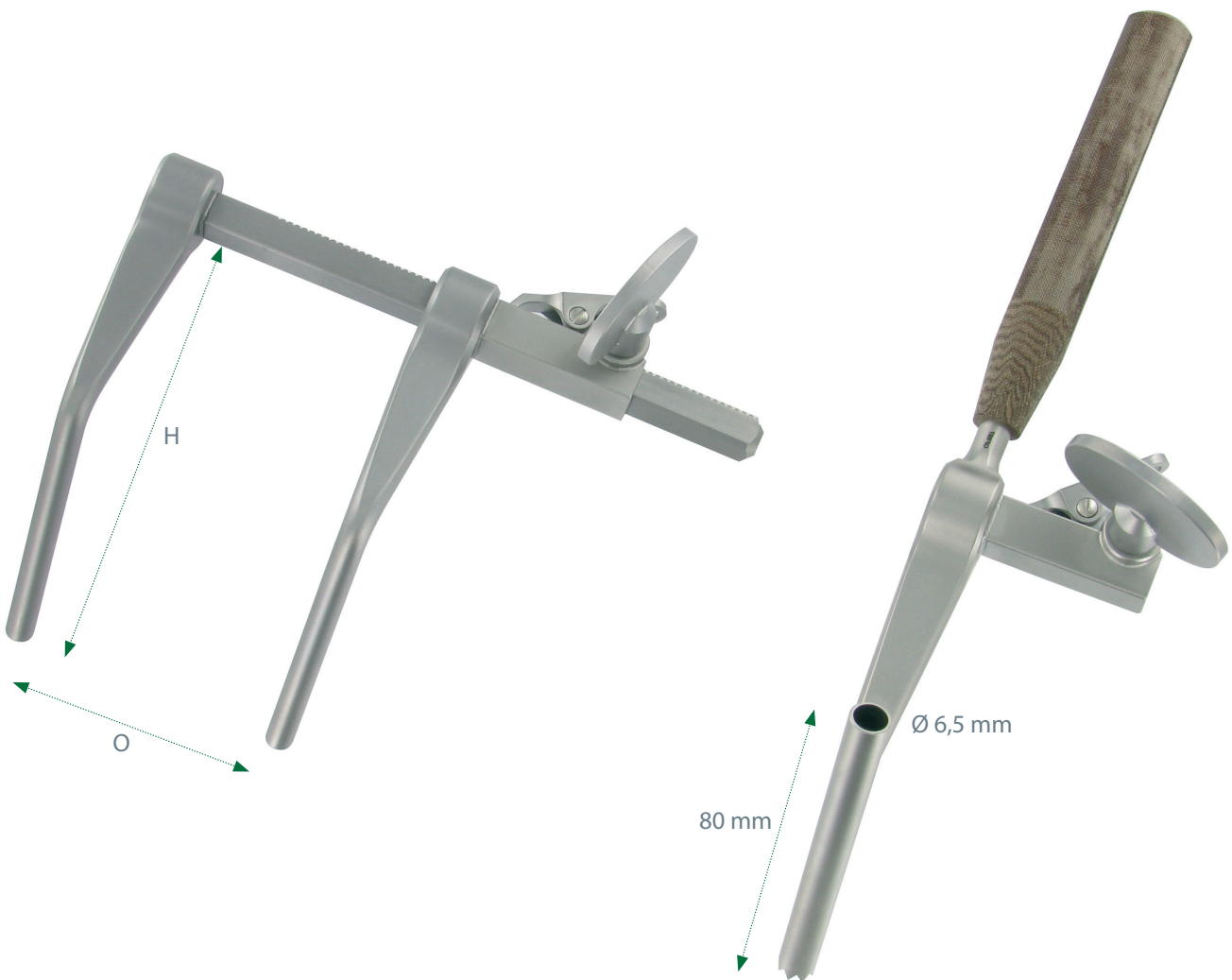

**J538803**  
10 cm - 4 "  
H : 9 cm - 3 1/2 " - O : 8 cm - 3 "

**J538805**  
21 cm - 9 "

IV - Écarteurs  
IV - Retractors



Tournevis  
Screwdriver



4 mm

**J538806**  
20 cm - 8 <sup>3</sup>/<sub>4</sub> "

Mèche de préperçage  
Drill bit for pre-drilling



**J538807**  
13,5 cm - 5 <sup>1</sup>/<sub>4</sub> "

Broche de distraction  
Distraction pins



**J538822**  
a : 12 mm - b : 66 mm

**J538824**  
a : 14 mm - b : 68 mm

**J538826**  
a : 16 mm - b : 70 mm

**J538828**  
a : 18 mm - b : 72 mm



Greffe osseuse - Bone graft

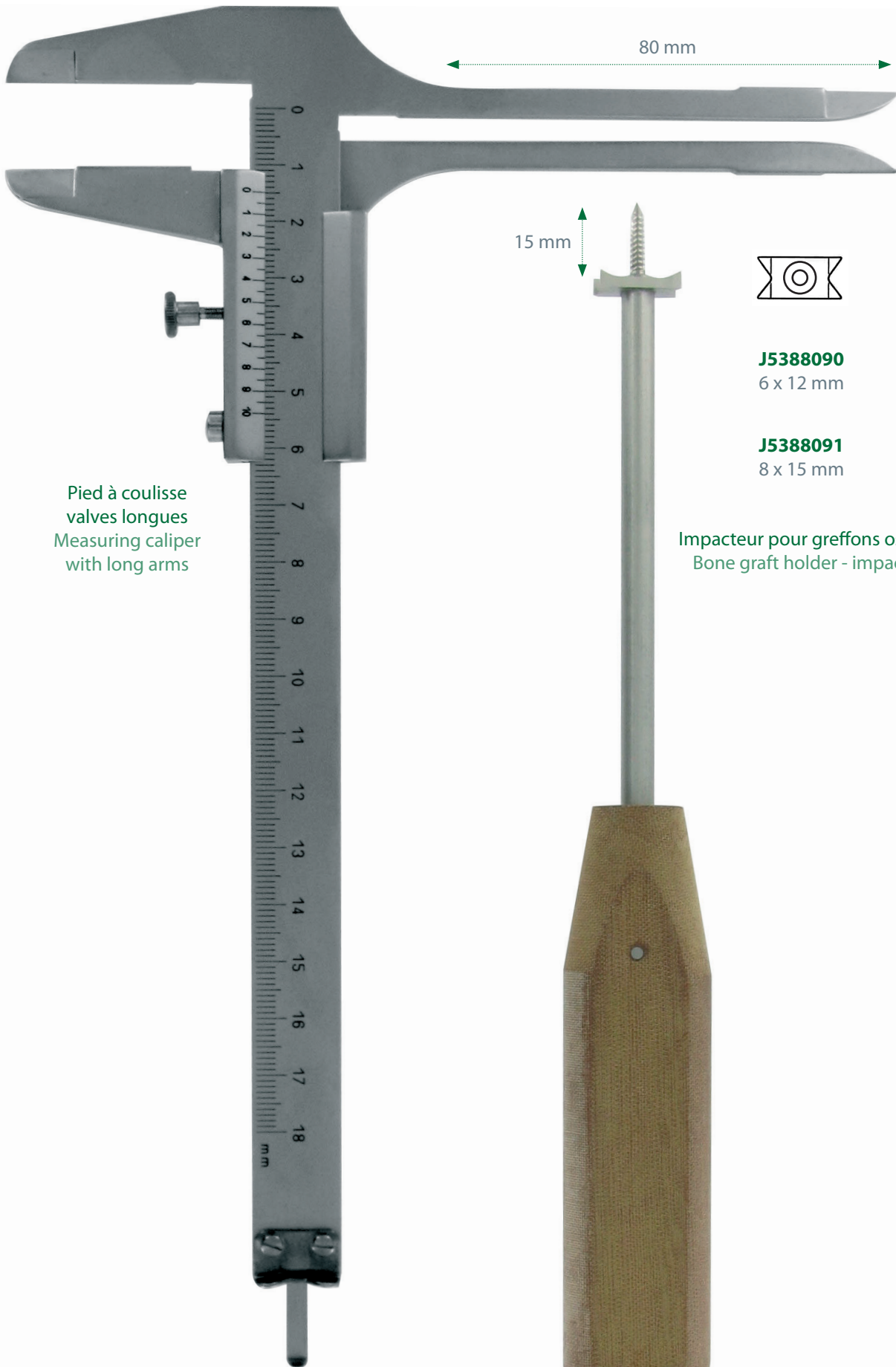

Pied à coulisse  
valves longues  
Measuring caliper  
with long arms

15 mm

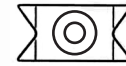

**J5388090**  
6 x 12 mm

**J5388091**  
8 x 15 mm

Impacteur pour greffons osseux  
Bone graft holder - impactor

**J538808**  
22,5 cm - 8 <sup>3</sup>/<sub>4</sub> "

**J5388090**  
22 cm - 8 <sup>3</sup>/<sub>4</sub> "

## Greffe osseuse - Bone graft



Chasse-greffons  
Graft pusher



**J538815**  
22 cm - 9"



Ø 5 mm



**J538813**  
Ø 3 mm



**J538815**  
Ø 5 mm



**J538818**  
Ø 8 mm

Dissecteur  
Dissector



**J538810**  
22 cm - 8"

Droit  
Straight



**J538810**

Courbé  
Curved



**J538811**

CASPAR



Système pour micro dissection lombaire  
Micro lumbar dissection retractor system

Revêtement céramique noir - Ceramic black coating

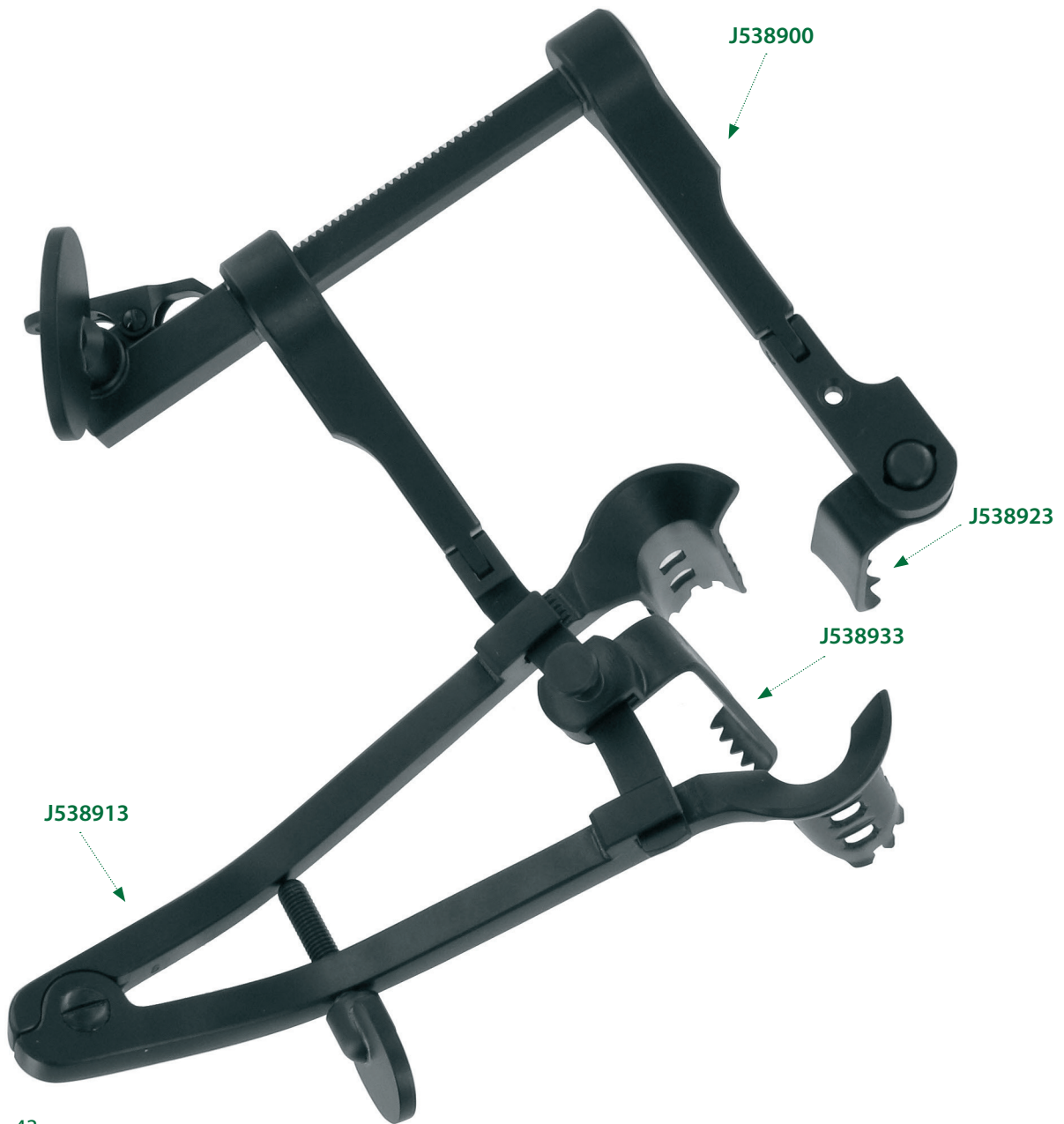

IV - Écarteurs  
IV - Retractors

Valves page : 43.  
Blades page : 43.

### CASPAR

Contre écarteur - Counter retractor  
 Revêtement céramique noir - Ceramic black coating

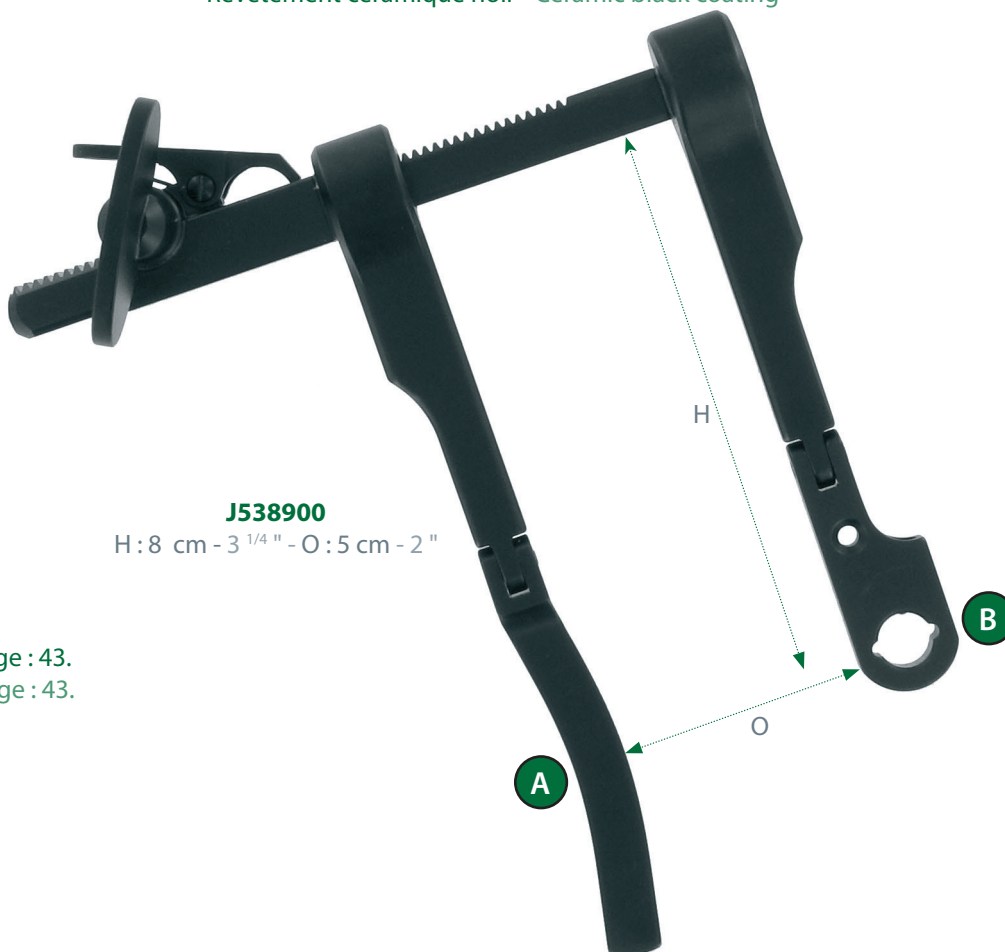

**J538900**

H : 8 cm - 3 1/4 " - O : 5 cm - 2 "

Valves page : 43.  
 Blades page : 43.

IV - Écarteurs  
 IV - Retractors

Speculum - Speculum  
 Revêtement céramique noir - Ceramic black coating



**J538913**

L : 5 cm - 2 " - O : 4 cm - 1 1/2 "

L : 40 mm	<b>J538911</b>
L : 45 mm	<b>J538912</b>
L : 50 mm	<b>J538913</b>
L : 55 mm	<b>J538914</b>
L : 60 mm	<b>J538915</b>
L : 65 mm	<b>J538916</b>
L : 75 mm	<b>J538917</b>
L : 85 mm	<b>J538918</b>

### CASPAR



Valves seules - Blades only  
 Revêtement céramique noir - Ceramic black coating

Médiane  
 Medial



**J538933**

40 mm	<b>J538930</b>
45 mm	<b>J538931</b>
50 mm	<b>J538932</b>
55 mm	<b>J538933</b>
60 mm	<b>J538934</b>
65 mm	<b>J538935</b>
70 mm	<b>J538936</b>

Latérale  
 Lateral



**J538923**

35 mm	<b>J538920</b>
40 mm	<b>J538921</b>
45 mm	<b>J538922</b>
50 mm	<b>J538923</b>
55 mm	<b>J538924</b>
60 mm	<b>J538925</b>
65 mm	<b>J538926</b>
75 mm	<b>J538927</b>
85 mm	<b>J538928</b>

IV - Écarteurs  
 IV - Retractors

Pince pour changer les valves  
 Forceps for changing the blades



**J538901**  
 11,5 cm - 4 1/2"



## Pinces rongeurs - Laminectomy rongeurs

CUSHING SPURLING  
LOVE-GRUENWALD



P 1

CASPAR



P 2

CASPAR



P 3

FERRIS-SMITH-CUSHING



P 4

WEIL-BLAKESLEY



P 5

TAKAHASHI



P 6

## Pinces emporte pièces - Punch forceps

FERRIS SMITH KERRISSON



P 7

Démontable  
Detachable



P 8

Démontable  
Detachable



P 9









### CUSHING

Largeur de mors Width of jaw	Longueur tige Length of shaft	Droite Straight	Vers le haut Upward	Vers le bas Downward
 2 x 10 mm	13 cm - 5 1/8 "	<b>J17001</b>	<b>J17002</b>	<b>J17003</b>
	15 cm - 6 "	<b>J170040</b>	<b>J170041</b>	<b>J170042</b>
	18 cm - 7 "	<b>J17005</b>	<b>J17006</b>	<b>J17007</b>

### LOVE-GRUENWALD

Largeur de mors Width of jaw	Longueur tige Length of shaft	Droite Straight	Vers le haut Upward	Vers le bas Downward
 3 x 10 mm	13 cm - 5 1/8 "	<b>J17010</b>	<b>J17012</b>	<b>J17015</b>
	15 cm - 6 "	<b>J170160</b>	<b>J170161</b>	<b>J170162</b>
	18 cm - 7 "	<b>J17020</b>	<b>J17025</b>	<b>J17035</b>

### SPURLING

Largeur de mors Width of jaw	Longueur tige Length of shaft	Droite Straight	Vers le haut Upward	Vers le bas Downward
 4 x 10 mm	13 cm - 5 1/8 "	<b>J17045</b>	<b>J17050</b>	<b>J17055</b>
	15 cm - 6 "	<b>J170560</b>	<b>J170561</b>	<b>J170562</b>
	18 cm - 7 "	<b>J17060</b>	<b>J17065</b>	<b>J17070</b>





### CASPAR



**J170925**



V - Rongeurs  
V - Rongeurs

	Largeur de mors Width of jaw	Longueur tige Length of shaft	Droite Straight	Vers le haut Upward	Vers le bas Downward
	2 x 12 mm	14 cm - 5 1/2 "	<b>J170910</b>	<b>J170911</b>	-
		16 cm - 6 1/4 "	<b>J170913</b>	<b>J170914</b>	-
		18,5 cm - 7 1/4 "	<b>J1709330</b>	-	-
	3 x 12 mm	14 cm - 5 1/2 "	<b>J170916</b>	<b>J170917</b>	-
		16 cm - 6 1/4 "	<b>J170919</b>	<b>J170920</b>	<b>J170921</b>
		18,5 cm - 7 1/4 "	<b>J1709333</b>	<b>J1709334</b>	<b>J1709335</b>
	4 x 14 mm	14 cm - 5 1/2 "	<b>J170922</b>	<b>J170923</b>	-
		16 cm - 6 1/4 "	<b>J170925</b>	<b>J170926</b>	<b>J170927</b>
		18,5 cm - 7 1/4 "	<b>J1709336</b>	<b>J1709337</b>	<b>J1709338</b>
	5 x 14 mm	14 cm - 5 1/2 "	<b>J170928</b>	<b>J170929</b>	-
		16 cm - 6 1/4 "	<b>J170931</b>	<b>J170932</b>	-
		18,5 cm - 7 1/4 "	<b>J1709339</b>	<b>J1709340</b>	-

### CASPAR





	Largeur de mors Width of jaw	Longueur tige Length of shaft	Droite Straight	Vers le haut Upward	Vers le bas Downward
	2 x 15 mm	15,5 cm - 6 1/8 "	<b>J1709380</b>	<b>J1709381</b>	<b>J1709382</b>
	3 x 15 mm	15,5 cm - 6 1/8 "	<b>J1709383</b>	<b>J1709384</b>	<b>J1709385</b>
	4 x 15 mm	15,5 cm - 6 1/8 "	<b>J1709386</b>	<b>J1709387</b>	<b>J1709388</b>
	5 x 15 mm	15,5 cm - 6 1/8 "	<b>J1709389</b>	-	-

V - Rongeurs  
V - Rongeurs

### FERRIS-SMITH-CUSHING







V - Rongeurs  
V - Rongeurs

	Largeur de mors Width of jaw	Longueur tige Length of shaft	Droite Straight	Vers le haut Upward	Vers le bas Downward
	2 x 10 mm	18 cm - 7 "	<b>J170750</b>	<b>J170751</b>	<b>J170752</b>
	3 x 10 mm	18 cm - 7 "	<b>J17080</b>	<b>J17085</b>	<b>J170860</b>
	4 x 10 mm	18 cm - 7 "	<b>J17090</b>	<b>J170898</b>	<b>J170899</b>

### WEIL-BLAKESLEY



	Largeur de mors Width of jaw	Longueur tige Length of shaft	Droite Straight	Vers le haut Upward
	3,0 mm	12 cm - 4 3/4 "	J170901	J170902
	3,5 mm	12 cm - 4 3/4 "	J170903	J170904
	4,5 mm	12 cm - 4 3/4 "	J170905	J170906
	5,0 mm	12 cm - 4 3/4 "	J170907	J170908
	5,6 mm	12 cm - 4 3/4 "	J170909	-

V - Rongeurs  
V - Rongeurs

### TAKAHASHI

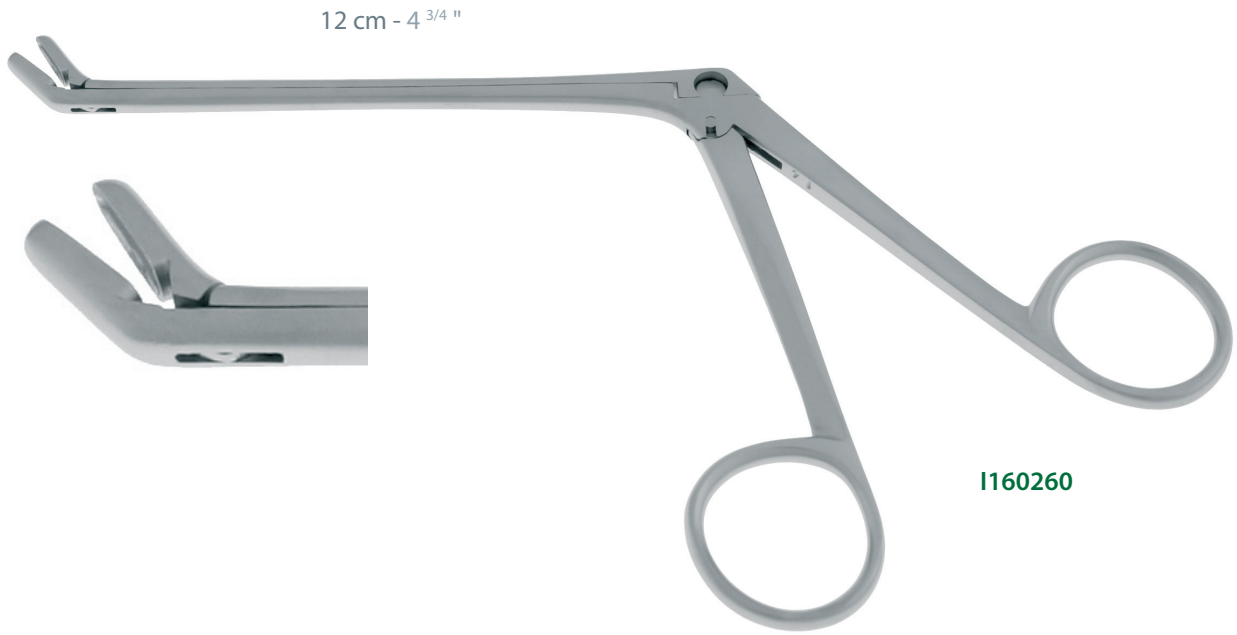

**I160260**



Largeur de mors  
Width of jaw

Longueur tige  
Length of shaft

Droite  
Straight

Vers le haut  
Upward



3,0 x 10 mm

12 cm - 4 <sup>3</sup>/<sub>4</sub> "

**I160250**

**I160260**

18 cm - 7 "

FERRIS SMITH KERRISSON

J17118

T = Talon fin  
T = Thin footplate



Largeur de mors Width of jaw	Longueur tige Length of shaft	90° Haut	40° Haut	90° Bas	40° Bas	40° Haut	40° Bas
		90° Upward	40° Upward	90° Downward	40° Downward	40° Upward	40° Downward
1 mm	18 cm - 7 "	J170940	J171170	J171821	J171831	J171170T	J171831T
	20 cm - 8 "	-	J172011	-	-	J172011T	-
	23 cm - 8 "	-	-	-	-	-	-
	28 cm - 11 "	-	-	-	-	-	-
2 mm	18 cm - 7 "	J17095	J17118	J171822	J171832	J171180T	J171832T
	20 cm - 8 "	-	J172012	-	-	J172012T	-
	23 cm - 8 "	-	J172312	-	-	J172312T	-
	28 cm - 11 "	-	-	-	-	-	-
3 mm	18 cm - 7 "	J17100	J17120	J171823	J171833	J171200T	J171833T
	20 cm - 8 "	J172003	J172013	J172023	-	J172013T	-
	23 cm - 8 "	-	J172313	-	J172333	J172313T	J172333T
	28 cm - 11 "	J172803	J172813	-	-	J172813T	-
4 mm	18 cm - 7 "	J17110	J17130	J171824	J171834	J171300T	J171834T
	20 cm - 8 "	J172004	J172014	J172024	-	J172014T	-
	23 cm - 8 "	-	J172314	-	J172334	J172314T	J172334T
	28 cm - 11 "	J172804	J172814	-	-	J172814T	-
5 mm	18 cm - 7 "	J17115	J17140	J171825	J171835	J171400T	J171835T
	20 cm - 8 "	J172005	J172015	J172025	-	J172015T	-
	23 cm - 8 "	-	J172315	-	J172335	J172315T	J172335T
	28 cm - 11 "	J172805	J172815	-	-	J172815T	-
6 mm	18 cm - 7 "	-	-	-	-	-	-
	20 cm - 8 "	-	J172016	-	-	J172016T	-
	23 cm - 8 "	-	-	-	-	-	-
	28 cm - 11 "	-	-	-	-	-	-



Largeur de mors Width of jaw		Longueur tige Length of shaft	90° Vers le haut 90° Upward	40° Vers le haut 40° Upward
1 mm	∩	18 cm - 7 "	<b>J191801</b>	<b>J191811</b>
		20 cm - 8 "	-	-
2 mm	∩	18 cm - 7 "	<b>J191802</b>	<b>J191812</b>
		20 cm - 8 "	-	-
3 mm	∩	18 cm - 7 "	<b>J191803</b>	<b>J191813</b>
		20 cm - 8 "	<b>J192003</b>	<b>J192013</b>
4 mm	∩	18 cm - 7 "	<b>J191804</b>	<b>J191814</b>
		20 cm - 8 "	<b>J192004</b>	<b>J192014</b>
5 mm	∩	18 cm - 7 "	<b>J191805</b>	<b>J191815</b>
		20 cm - 8 "	<b>J192005</b>	<b>J192015</b>





B = Revêtement céramique noir  
B = Black ceramic coating

E = Éjecteur  
E = Ejector



Largueur de mors Width of jaw	Longueur tige Length of shaft	90° Haut 90° Upward	40° Haut 40° Upward	40° Bas 40° Downward	40° Haut 40° Upward	40° Haut 40° Upward	40° Haut 40° Upward
1 mm	18 cm - 7"	J201831E	J201811E	-	J201811EB	J201811ET	J201811ETB
	20 cm - 8"	-	J202011E	-	J202011EB	J202011ET	J202011ETB
	23 cm - 8"	-	-	-	-	-	-
	28 cm - 11"	-	-	-	-	-	-
2 mm	18 cm - 7"	J201832E	J201812E	-	J201812EB	J201812ET	J201812ETB
	20 cm - 8"	-	J202012E	-	J202012EB	J202012ET	J202012ETB
	23 cm - 8"	-	J202312E	-	J202312EB	J202312ET	J202312ETB
	28 cm - 11"	-	-	-	-	-	-
3 mm	18 cm - 7"	J201833E	J201813E	J201823E	J201813EB	J201813ET	J201813ETB
	20 cm - 8"	-	J202013E	-	J202013EB	J202013ET	J202013ETB
	23 cm - 8"	-	J202313E	J202323E	J202313EB	J202313ET	J202313ETB
	28 cm - 11"	-	-	-	-	-	-
4 mm	18 cm - 7"	J201834E	J201814E	J201824E	J201814EB	J201814ET	J201814ETB
	20 cm - 8"	-	J202014E	-	J202014EB	J202014ET	J202014ETB
	23 cm - 8"	-	J202314E	J202324E	J202314EB	J202314ET	J202314ETB
	28 cm - 11"	-	-	-	-	-	-
5 mm	18 cm - 7"	J201835E	J201815E	J201825E	J201815EB	J201815ET	J201815ETB
	20 cm - 8"	-	J202015E	-	J202015EB	J202015ET	J202015ETB
	23 cm - 8"	-	J202315E	J202325E	J202315EB	J202315ET	J202315ETB
	28 cm - 11"	-	-	-	-	-	-
6 mm	18 cm - 7"	-	-	-	-	-	-
	20 cm - 8"	-	J202016E	-	J202016EB	-	-
	23 cm - 8"	-	-	-	-	-	-
	28 cm - 11"	-	-	-	-	-	-



## Clips pour le scalpe - Scalp clips

RANEY

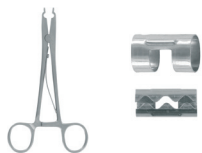

P 1

KOLNER



P 1

## Perforateur manuel - Manual bone drill

HUDSON



P 2

DOYEN



P 3

## Fil scie - Wire saw

GIGLI



P 4

OLIVECRONA



P 4

MARTEL



P 4

GALEA



P 5

## Crochet à ressort - Spring hook

## Pince grignoteuse - Cutting forceps

DAHLGREN



P 6

## Étrier crânien - Skull traction tongs

CRUTCHFIELD

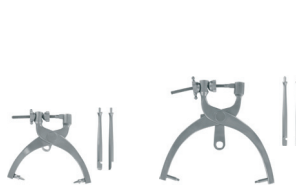

P 7



P 7

## Écarteur crânien - Skull retractor

YASARGIL

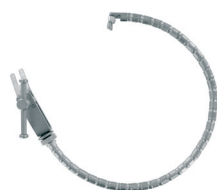

P 8



P 9

## Écarteur pour table d'opération Retractor for operating table



P 10



P 10



P 10



**RANEY**

Pince pour appliquer et retirer les clips  
 Forceps for applying and removing the clips



**J163400**  
 16 cm - 6 1/4 "

Clip pour hémostase du scalpe  
 Scalp hemostasis clip



Boîte de 12  
 Package of 12

**J163410**

**KOLNER**

Clip pour le scalpe  
 Scalp clip

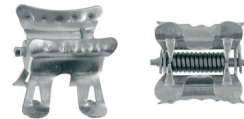

Boîte de 50  
 Package of 50

**J163390**

Boîte de 10  
 Package of 10

**J163391**

Perforateur initial  
Initial drill



**J161010**  
Ø 9 mm



**J161020**  
Ø 14 mm



**J161030**  
Ø 16 mm



**J161040**  
Ø 22 mm

**CUSHING**



**J161050**  
Ø 14 mm

Rallonge  
Extension piece



**J161060**

**HUDSON**



Perforateur seul  
Drill only

**J161000**

**McKENZIE**



**J161080**  
Ø 13 mm



**J161090**  
Ø 2 mm

**ERRICO**



**J161100**  
Ø 16 mm

Perforateur initial  
Initial drill



**J16020**  
Ø 11 mm

**DOYEN**



**J16030**  
Ø 4 mm



**J16040**  
Ø 8 mm



**J16050**  
Ø 12 mm



**J16060**  
Ø 16 mm

**CLOVIS VINCENT**



**J16065**  
Ø 14 mm

**DOYEN**  
**(Couronne de Trépan)**

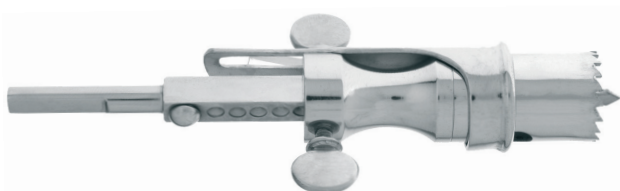

Ø 15 mm

**J16075**

Ø 20 mm

**J160760**

Ø 25 mm

**J160770**

Ø 30 mm

**J160780**

Ø 35 mm

**J160790**

**DOYEN**



Perforateur seul  
Drill only

**J16010**



GIGLI



- J12250**  
45 cm - 17 <sup>3</sup>/<sub>4</sub> "
- J122530**  
30 cm - 11 <sup>3</sup>/<sub>4</sub> "
- J122540**  
40 cm - 15 <sup>3</sup>/<sub>4</sub> "
- J122550**  
50 cm - 19 <sup>5</sup>/<sub>8</sub> "

MARTEL

Conducteur à crochet simple  
Conductor with simple hook



OLIVECRONA

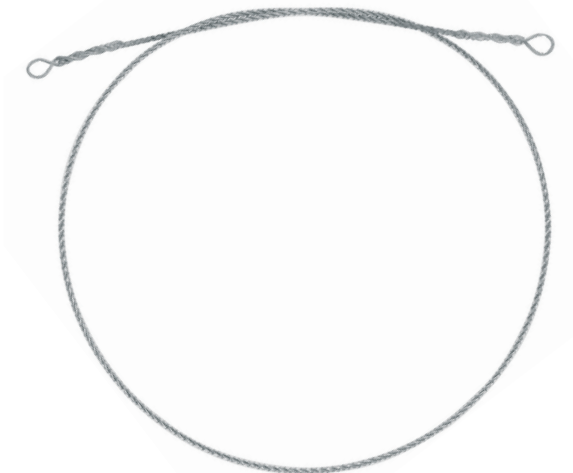

- J122590**  
30 cm - 11 <sup>3</sup>/<sub>4</sub> "
- J12260**  
40 cm - 15 <sup>3</sup>/<sub>4</sub> "
- J122610**  
50 cm - 19 <sup>5</sup>/<sub>8</sub> "

Poignée pour scie  
Handle for saw



**J12240**  
6 cm - 2 <sup>1</sup>/<sub>3</sub> "



**J12285**  
33 cm - 13 "



## Crochet à ressort - Hook with spring



GALEA



Avec clamp Bulldog  
With Bulldog clamp

**J122907**  
42 cm - 16 1/2"  
7 mm



**J122907**  
7 mm

**J122909**  
9 mm

DAHLGREN



Avec deux crochets  
With two hooks

**J682000**  
20 cm - 7 7/8 "



CRUTCHFIELD

Petit - Small

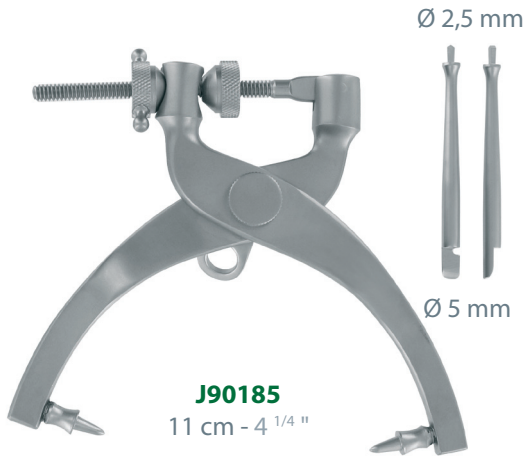

**J90185**  
11 cm - 4 1/4 "

Moyen - Medium

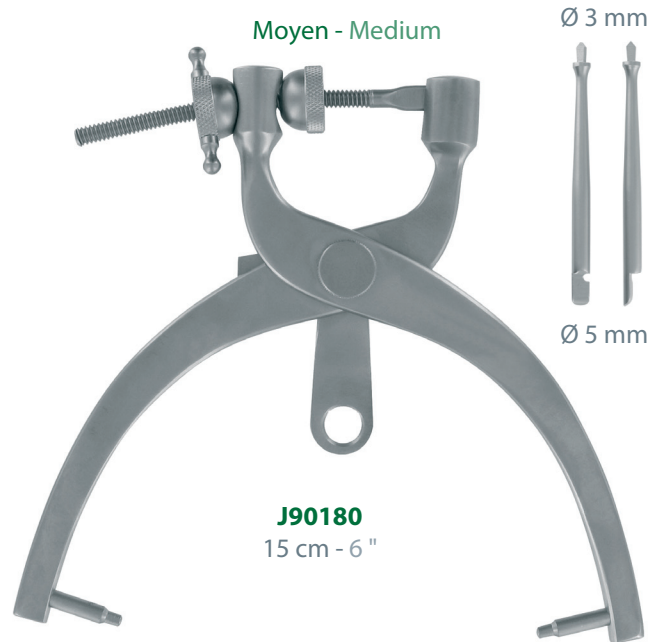

**J90180**  
15 cm - 6 "

Grand - Large



**J90190**  
24 cm - 9 1/2 "

Pour J90190 - For J90190



**J90200**

YASARGIL



**B**



**A**



**J155000**

Bras flexible autostatique seul  
Flexible autostatic arm only

YASARGIL



**J155010**

Dispositif de fixation pour un bras  
Fixation base for holding one flexible arm



**J155020**

Dispositif de fixation pour deux bras  
Fixation base for holding two flexible arm

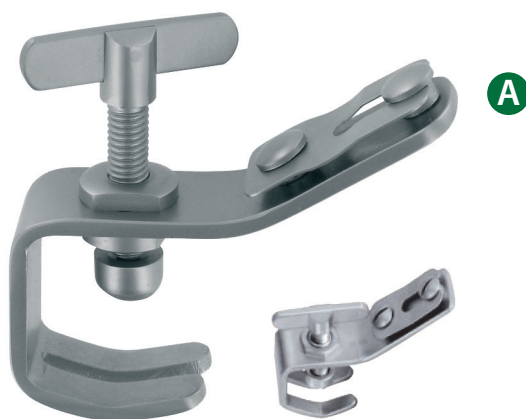

**J155058**

Dispositif de fixation pour un bras sur tube jusqu'à Ø 16 mm  
Fixation base for holding one flexible arm for mounting on bars up to Ø 16 mm

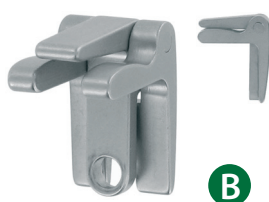

**J155030**

Porte-spatule pour spatules plates  
Support for flat spatulas



**J155031**

Porte-spatule pour spatules avec tiges Ø 4 et Ø 5 mm  
Support for spatulas with round shaft Ø 4 and Ø 5 mm

## Écarteur crânien - Skull retractor

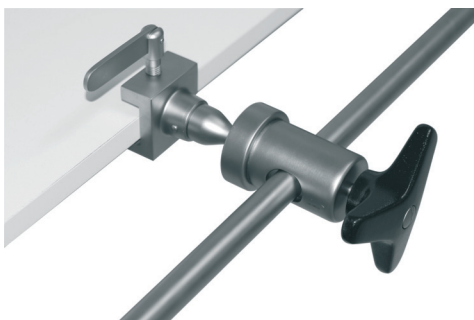

**J155054**

Dispositif à rotule pour fixation sur table d'opération  
Ball and socket joint for fixation on the operating table

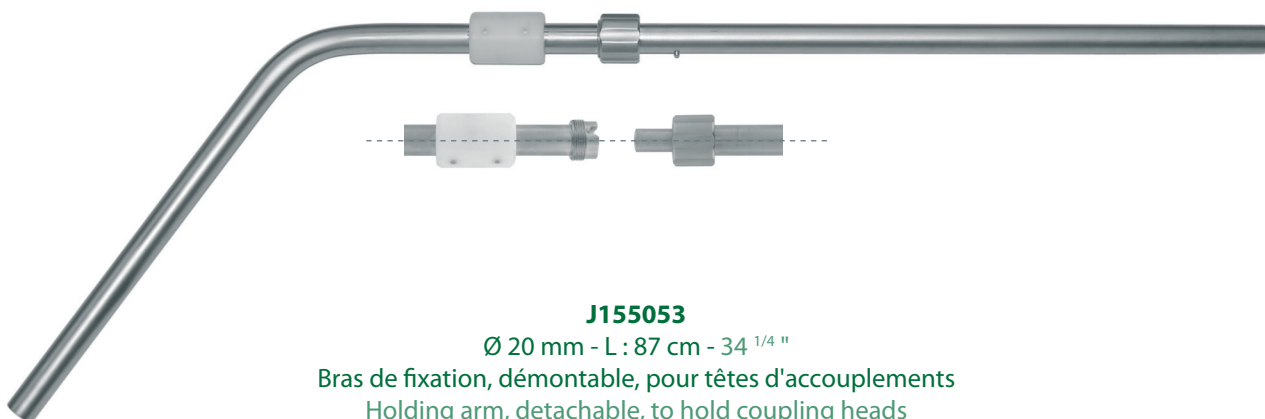

**J155053**

Ø 20 mm - L : 87 cm - 34 1/4 "

Bras de fixation, démontable, pour têtes d'accouplements  
Holding arm, detachable, to hold coupling heads

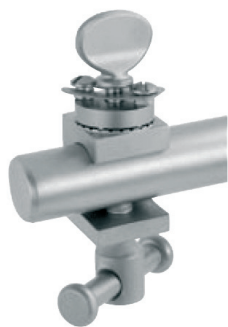

**J155055**

Tête d'accouplement pour le maintien d'un bras flexible  
Coupling head to hold one flexible arm

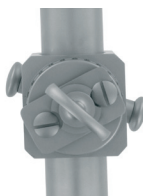

**J155056**

Tête d'accouplement rotative pour le maintien d'un bras flexible  
Rotatable coupling head to hold one flexible arm

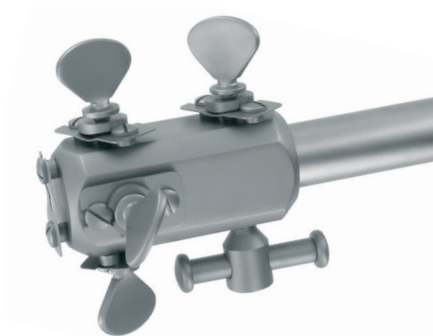

**J155057**

Tête d'accouplement pour le maintien de 5 bras flexibles  
Coupling head to hold five flexible arms

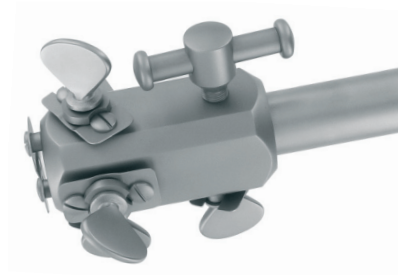

## Pince à tumeur - Tumor grasping forceps

TOENNIS



P 1

## Miroirs - Mirrors



P 2

## Spéculum - Speculum

LANDOLT CUSHING-LANDOLT



P 3



P 3

PAPAVERO CASPAR



P 4

LANDOLT



P 4

COTTLE



P 5

## Micro curettes - Micro curettes

RAY

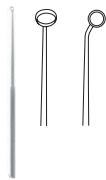

P 6

HARDY



P 6

FAHLBUSCH



P 6

## Micro dissecteur - Micro dissector

HARDY-FAHLBUSCH



P 7

## Porte implant - Implant holder

HARDY



P 7

## Micro crochet - Micro hook

LANDOLT-REULEN



P 8

## Micro dissecteur - Micro dissector



P 8

## Micro curette - Micro curette



P 8

## Micro ciseaux - Micro scissors

CASPAR



P 9

FAHLBUSCH



NICOLA



P 10

YASARGIL-NICOLA







TOENNIS



**J231601**  
7 mm



**J231602**  
10 mm



**J231603**  
12 mm

**J231601**  
20 cm - 7 7/8 "



### LANDOLT

### CUSHING-LANDOLT



Écarteur pour spéculum  
Spreader for speculum



**J231205**  
21 cm - 8 1/4 "



**J231290**  
14 cm - 5 1/2 "

L : 7 cm - H : 15 mm

**J231270**

L : 9 cm - H : 15 mm

**J231290**

L : 11 cm - H : 15 mm

**J231210**

Spéculum - Speculum



PAPAVERO-CASPAR

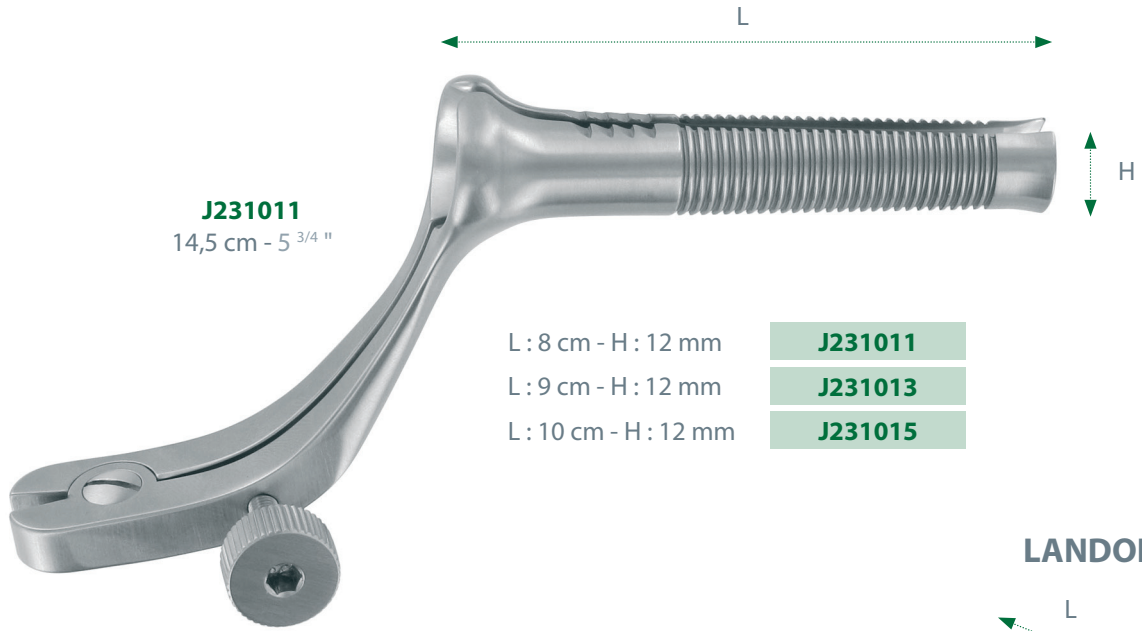

**J231011**  
14,5 cm - 5 3/4 "

- L : 8 cm - H : 12 mm
- L : 9 cm - H : 12 mm
- L : 10 cm - H : 12 mm

- J231011**
- J231013**
- J231015**

⬡ 4 mm

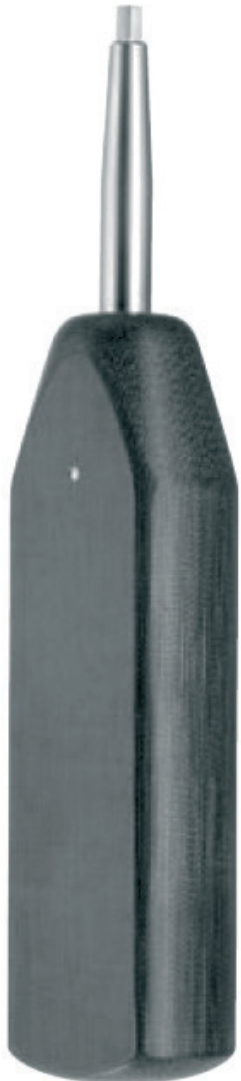

Pour / For  
J231011  
J231013  
J231015

**J231030**  
14,5 cm - 5 3/4 "

LANDOLT



**J231035**  
15 cm - 6 "  
L : 34 mm

COTTLE

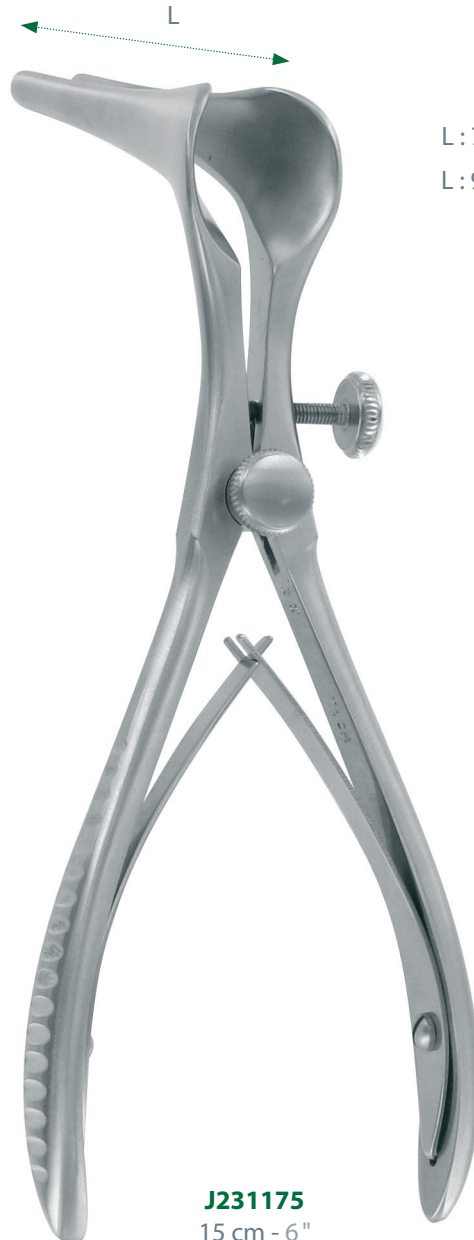

L : 7,5 cm - 3 "

**J231175**

L : 9 cm - 3 1/2 "

**J231190**

**J231175**  
15 cm - 6 "

## Micro curettes - Micro curettes

RAY



Incliné vers l'avant 45°  
Angled forwards 45°

**J231320**  
Ø 4 mm  
19 cm - 7 1/2 "

Coudé sur le côté 45°  
Angled laterally 45°

**J231321**  
Ø 4 mm  
19 cm - 7 1/2 "

HARDY



Malléable  
Malleable

**J231330**  
Ø 4 mm  
26 cm - 10 1/4 "

**J231331**  
Ø 6 mm  
26 cm - 10 1/4 "

FAHLBUSCH

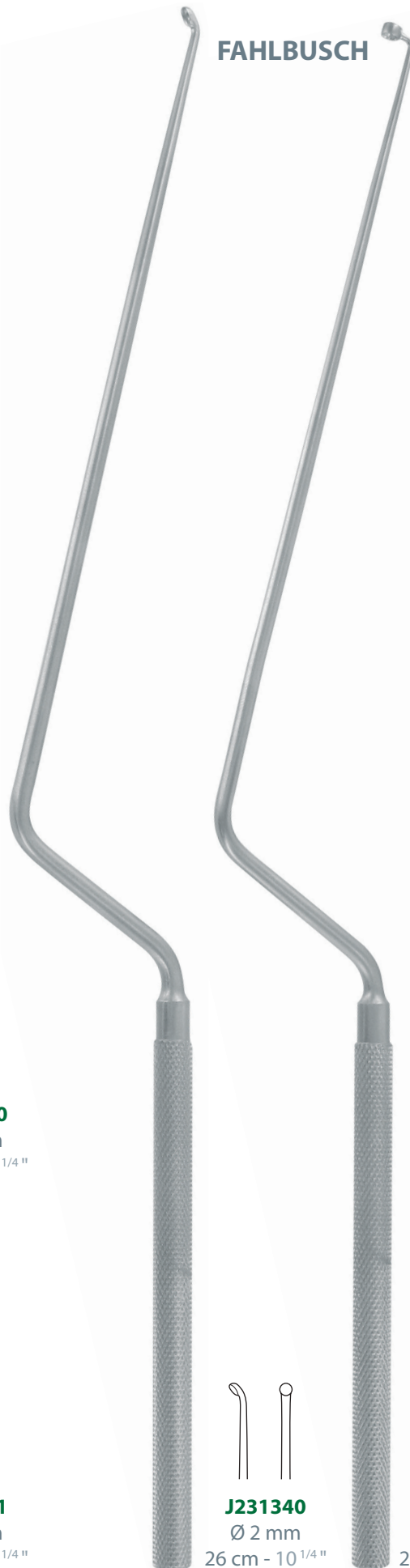

**J231340**  
Ø 2 mm  
26 cm - 10 1/4 "

**J231341**  
Ø 2,5 mm  
26 cm - 10 1/4 "





**HARDY**

Porte implant  
Implant holder



**J231115**  
24,5 cm - 9 5/8 "

**HARDY-FAHLBUSCH**



Courbe en haut  
Upward curved

Courbe en bas  
Downward curved



**J231310**  
24,5 cm - 9 5/8 "



**J231311**  
24,5 cm - 9 5/8 "

## LANDOLT-REULEN



Crochet, mousse rigide  
Hook, blunt rigid



**J231350**  
1,7 mm  
26 cm - 10<sup>1/4</sup>''



Dissecteur, rigide  
Dissector, rigid



**J231351**  
2 mm  
26 cm - 10<sup>1/4</sup>''



Curette, rigide  
Curette, rigid

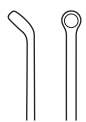

**J231352**  
Ø 2,5 mm  
26 cm - 10<sup>1/4</sup>''



CASPAR



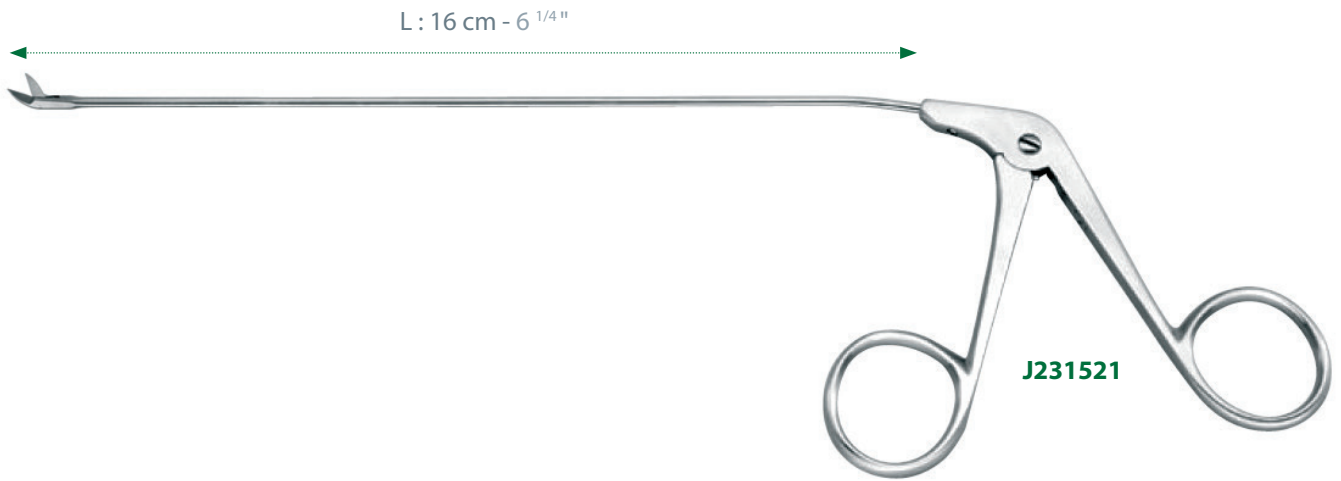

### FAHLBUSCH

Courbe en haut - Curved up



J231521

### NICOLA



J231510

Ø 2,5 mm

### NICOLA



J231541

### YASARGIL - NICOLA

Mors coniques - Conical jaws



J231530

9 mm



Siège - *Corporate Office*  
13, Avenue de la République - 75011 Paris - France

Service Clients et Production - *Customer Service and Manufacturing*  
Z.I. la Vendue - B.P. 2152 - 52906 Chaumont Cedex 9 - France  
Tél.: +33 (0) 3 25 02 10 10 - Fax : +33 (0) 3 25 02 10 20 - Email : [contact@landanger.com](mailto:contact@landanger.com)  
[www.landanger.com](http://www.landanger.com)

LANDANGER



# Recommandations de base



*pour la pré-désinfection  
le nettoyage  
et la stérilisation  
des instruments chirurgicaux*



# Recommandations de base pour la pré-désinfection, le nettoyage et la stérilisation des instruments chirurgicaux.

Édition : février 2006

*Pharmacien conseil :*

**Dr I. Hermelin-Jobet**

Pharmacienne Praticien hospitalier

CHR Orléans





# Sommaire

<b>1 Normes AFNOR</b>	<b>Page 5</b>
<b>2 Le lavage des instruments</b>	<b>Page 7</b>
Réception	
Lavage des instruments neufs	
La pré-désinfection	
Stérilisation par vapeur d'eau (hydrolyse)	
Traitement de l'instrumentation chirurgicale à la sortie du bloc opératoire	
<b>3 La lubrification des instruments</b>	<b>Page 13</b>
<b>4 Rénover vos instruments</b>	<b>Page 17</b>
Landax 101	
Informations techniques	
<b>5 Procédure d'inactivation des ATCN</b>	<b>Page 21</b>
Nous vous conseillons la procédure d'inactivation des ATCN à la soude 1N	
<b>6 Annexes</b>	<b>Page 25</b>
Annexe 1	
Annexe 2	
Annexe 3	
Annexe 4	



# Normes AFNOR

(Association Française de NORmalisation)



# Normes AFNOR

(Association Française de **NOR**malisation)

Applicables sur les instruments de chirurgie

Les aciers entrant dans la fabrication de l'instrumentation Landanger S.A. sont d'origine européenne.

Les aciers inoxydables utilisés (composition chimique et dureté) correspondent aux normes :

- NF S 94090-11/2005 pour les instruments chirurgicaux
- NF EN ISO 7153-1- 12/2000 partie 1 pour les aciers inoxydables.

Les dimensions vocabulaire et essais (résistance à la corrosion - essais mécaniques) respectent les normes :

- NF S 90460-08/1982 pour les pinces hémostatiques,
- NF S 90461-08/1982 pour les pinces passe-fils et porte-aiguilles,
- NF S 90462-08/1982 pour les couteaux, pinces à disséquer, bistouris, sondes,
- NF S 90463-08/1982 pour les ciseaux,
- NF EN 27740/A1-04/1998 pour les bistouris à lames détachables,
- NF EN 12011-04/1998 exigences générales pour les associations d'instrumentation et d'implants chirurgicaux non actifs,
- NF S 94469-07/2004 pour la définition des terminologies instrumentales.

# Le lavage des instruments



## Réception–Lavage des instruments neufs

La réception d'un instrument neuf ne devra être confiée qu'à un personnel instruit des procédures à effectuer.

Après contrôle de la conformité à la commande, ce matériel pourra être déballé et il conviendra avant tout traitement de s'assurer de son bon état de fonctionnement.

Un instrument qui pourrait paraître déficient devra être retourné dans son emballage d'origine en s'abstenant de toute tentative de « bricolage » sous peine d'annulation de la garantie.

Le test au sulfate de cuivre tel que préconisé par l'AFNOR n'a aucune valeur pour valider la qualité d'un acier inoxydable de type Martensitique et ne peut qu'induire en erreur par des résultats faussement positifs.

Le test à l'eau bouillante (ISO 13402-12/2002) tel que préconisé par l'AFNOR n'offre pas d'intérêt si l'approvisionnement a été réalisé auprès d'un fournisseur qualifié.

**Si l'instrument ne doit pas être mis en service immédiatement, effectuer :**

- dès réception le contrôle de conformité à la commande,
- effectuer un cycle de nettoyage spécifique de l'instrumentation neuve, (voir paragraphe suivant).
- contrôler l'aspect et le fonctionnement,

Le stocker alors :

- dans un local sec et propre,
- hors de son emballage plastique,
- loin de toute solution acide, même sous récipient fermé,
- à l'écart de tout métal de composition autre et surtout ferreux (dans une ancienne boîte chromée, au contact d'un instrument chromé, etc.),
- à l'abri de toute surcharge,
- selon une classification permettant une identification facile.

**Si l'instrument doit être mis en service :**

- 1<sup>er</sup> lavage en machine avec cycle habituel de nettoyage SANS lubrification
- examen de l'instrumentation pour écarter d'éventuelles anomalies
- 2<sup>e</sup> lavage en machine avec cycle habituel de nettoyage SANS lubrification
- examen de l'instrumentation pour écarter d'éventuelles anomalies
- 3<sup>e</sup> lavage en machine avec cycle habituel de nettoyage AVEC lubrification finale
- vérification d'aspect et de fonctionnement de l'ensemble de l'instrumentation :
  - les instruments portant des traces de corrosion résiduelle de fabrication, de stockage, de lavage feront l'objet d'un trempage en bain de rénovation LANDAX (en ultrason, 5 minutes à 5% à une température de 45-50°C, renouvelable une fois).
  - le matériel non conforme à l'issue de ce protocole devra faire l'objet d'un isolement et d'une information du fabricant.
  - le matériel conforme sera mis en service après un dernier cycle de lavage avec lubrification afin d'éliminer les résidus du liquide de rénovation.
  - conditionnement ou stockage.

**Attention :**

Des résidus d'huile de stockage mal détergés donnent, après stérilisation, un aspect de rouille sur l'instrument et peuvent fixer des dépôts organiques ultérieurs.

Quelle que soit la méthode utilisée, il convient :

- de ne jamais laver des dispositifs médicaux neufs avec ceux déjà utilisés,
- de ne jamais laver conjointement des instruments chromés et inoxydables,
- d'éviter les contacts avec des solutions agressives à base :
  - d'ions halogénures : chlorures,
  - d'iodures : polyvinylpyrrolidone iodée : Bétadine® ...
  - de chlorhexidine : Hibitane®....
- de faire le choix d'un bon produit détergent :
  - ne contenant ni chlore ni chlorure,
  - ne contenant pas d'acide,
  - ne contenant pas d'abrasif.

Les meilleurs résultats sont obtenus avec des détergents-dégraissants contenant :

- phosphates,
- polyphosphates,
- alcools gras polyéthoxylés,
- sels minéraux à alcalinité tamponnée.

L'eau utilisée pour le lavage doit être :

- filtrée,
- de qualité potable,
- faible en teneur d'ions calcaires donc adoucie si besoin entre 6 et 8 TH, voir les recommandations des fournisseurs des équipements de lavage et produits lessiviels.

Une eau trop dure inhibera le détergent et laissera après séchage un dépôt blanc sur le matériel :

- faible en éléments chlore ou en chlorure : < 20 mg/l,
- faible en teneur d'éléments minéraux (cuivre et fer principalement),
- se méfier des eaux trop adoucies qui contiennent des chlorures de sodium très corrosifs (attention à deux adoucisseurs en cascades),
- préférer l'eau permutée ou osmosée pour le rinçage à tout autre système d'épuration.

L'UTILISATION DE BROSSES METALLIQUES ET DE TAMPONS A RECURER POUR LE NETTOYAGE DE L'INSTRUMENTATION EST PROSCRITE.

## La pré-désinfection

Il faudra exclure du choix les produits contenant des phénols, des chlores actifs ou des chlorures à cause de leur capacité à corroder.

Il faudra exclure les aldéhydes pour leur pouvoir de renforcement des Prions à l'action de la vapeur, leur pouvoir allergisant et toxique et leur capacité à corroder.

### La réalisation de la pré-désinfection :

- traiter à part les instruments chromés, à limiter au maximum quant à leur usage.
- la pré-désinfection doit être effectuée immédiatement après utilisation.
- la dureté de l'eau doit être comprise entre 4°TH et 8°TH. Une eau dure inhibe l'efficacité antimicrobienne et peut entraîner des dépôts calcaires sur le matériel lors de l'utilisation de certains types de produits.
- la teneur en chlore de l'eau de dilution doit être inférieure à 20 mg/litre pour éviter tout risque de corrosion de l'instrumentation chirurgicale.
- la teneur de l'eau en éléments minéraux : fer, cuivre, manganèse, doit être la plus faible possible, au risque de voir ces éléments se fixer sur l'instrumentation et lui conférer, au fil du temps, une patine d'aspect bronze ou de rouille : irisation des instruments.
- respecter scrupuleusement la concentration en produit, qu'il ne faut en aucun cas ni augmenter, ni diminuer au risque de compromettre l'efficacité ou d'accroître les effets indésirables.
- ne jamais mélanger les produits entre eux, surtout ne pas ajouter de détergent.
- la température du bain doit être, sauf pour les enzymes protéolytiques, d'environ 20° C. Si l'odeur du produit se diffuse, la température de l'eau est trop élevée et les principes actifs se volatilisent au détriment de l'efficacité.
- l'immersion des instruments doit être totale pour que la pré-désinfection soit étendue à toute la surface de l'instrument mais aussi pour éviter l'effet pile entre l'air et l'eau, à la surface du bain, ce qui se traduirait par une amorce de corrosion.
- respecter le temps de trempage. Un temps de trempage trop court compromettrait l'action décontaminante, un temps trop prolongé, avec certains produits corrosifs, induirait une détérioration irréversible de l'instrumentation.
- en règle générale, quel que soit le produit retenu, le temps d'immersion des instruments ne devra jamais excéder 30 minutes en respectant scrupuleusement la concentration préconisée par le laboratoire.
- changer le bain à rythme adéquat :
  - après chaque intervention au bloc : souillure agressive
  - après 24 h en service de soins
  - attention l'eau pour fabriquer le bain s'évapore toujours un peu selon la température (risque de surconcentration en produit pré désinfectant) risque de corrosion.



## Stérilisation par vapeur d'eau (hydrolyse)

134° C – 18 minutes

(Circulaire DGS/5C/DHOS/E2/2001/ n°138 du 14 mars 2001)

Quel que soit le système de production de vapeur, il conviendra de s'assurer par des contrôles et analyses de la pureté de l'eau servant à cette production.

Cette eau doit être :

- de qualité potable, filtrée dans tous les cas,
- d'une dureté n'excédant pas 5 à 7° TH (1TH = 10 mg de carbonate de calcium / l. d'eau), dans l'idéal l'eau d'alimentation des générateurs d'autoclaves sera à TH=0,
- dépourvue d'éléments chlore et de chlorures : < 2 mg/litre,
- d'une teneur en phosphate < 0,5 mg/l,
- d'une teneur en éléments minéraux pratiquement nulle :
  - Silice : < 1 mg/l,
  - Fer : < 0.2 mg/l,
  - Cadmium : < 0.005 mg/l,
  - Plomb : < 0.05 mg/l,
  - Métaux lourds sauf plomb, fer, cadmium : < 0,1 mg/l.

Une eau adoucie est donc utilisée voire si possible osmosée.

Cette eau ne doit contenir :

- ni tanate,
- ni sulfite,
- ni amine,
- ni hydrazine,
- ni chlorure,
- ni permovapoline,

Produits habituellement utilisés par les chauffagistes pour prévenir la corrosion ou remédier à des sédimentations dans les tuyauteries.

Ces produits sont très corrosifs pour l'instrumentation chirurgicale mais aussi pour l'autoclave dont l'intérieur de cuve est en général en inox 316 L.

## Traitement de l'instrumentation chirurgicale à la sortie du bloc opératoire

1. Trempage de pré-désinfection plus brossage, si besoin est. Un trempage entre 15 et 30 minutes maximum réduit les risques de corrosion de l'instrumentation, par stagnation dans un milieu potentiellement agressif. Après le trempage, examen visuel.
  2. Rinçage manuel (douchette-eau froide).
  3. Lavage en machine.
  4. Rincage en machine (obligatoire) si possible eau osmosée.
  5. Contrôle visuel des instruments :
    - Eliminer les instruments mal lavés,
    - Traiter ces instruments à la main ou aux ultra-sons,
    - Eventuellement, passage au Landax immédiat si traces de corrosion,
    - Laver en machine selon le protocole habituel,
    - Rinçage et séchage manuel,
    - Lubrification.
  6. Conditionnement.
  7. Stérilisation autoclave.
  8. Stockage.
- 

# Lubrification des instruments



## La lubrification des instruments

### Lubrification machine

Le produit utilisé sera celui recommandé par les fournisseurs des équipements de lavage ou celui validé par chaque site.

La lubrification devrait être effectuée en machine lors du dernier cycle de rinçage, en cas de mauvais dosage, un relargage est possible lors de la stérilisation entraînant des taches sur les emballages.

Nous recommandons par exemple le produit NeoDisher IP Spray dont le descriptif est ci-joint.





## Lubrification manuelle

neodisher® IP Spray

Référence : V 78070

Produit de lubrification des instruments chirurgicaux à base d'huile de paraffine médicale sous forme de spray, sans CFC

### Application :

- Hôpitaux, cliniques, cabinets de soins, laboratoires pharmaceutiques,
- Médecine vétérinaire,
- Cabinets et cliniques dentaires. Stomatologie.

### Marquage CE

### neodisher® IP Spray :

Le neodisher® IP Spray est utilisé par vaporisation sur les instruments chirurgicaux, lorsque la lubrification automatique en machine n'est pas suffisante ou lorsque la machine ne prévoit pas de dosage du neodisher® IP Konz. Pour la vaporisation des paniers de stérilisation, on utilise le pulvérisateur sans gicleur auxiliaire. Lors de la lubrification d'instruments anguleux et articulés, ceux-ci peuvent être fixés directement au gicleur auxiliaire.

### Remarque :

*Les films d'huile de neodisher® IP Spray sur les surfaces n'influencent pas la stérilisation dans le stérilisateur à vapeur.*

### Propriétés technologiques :

Composants selon la recommandation européenne :

- 5-15% de tensioactifs non ioniques,
- > 30% d'hydrocarbures aliphatiques (huile de paraffine médicale DAB) et autres hydrocarbures aliphatiques.

Autres composants :

- gaz propulseur (propane/butane).

Biodégradabilité :

- répond à la réglementation en vigueur.

Stockage :

- la température de stockage doit se situer entre 5°C et 25°C.

Indications de risques et mesures de sécurité :

- la caractéristique du produit se fait sur la base de la directive européenne 75/234 pour les aérosols,
- symbole du danger : **F+**
- désignation du danger : **extrêmement inflammable**

**Indications :**

Flacon sous pression. À protéger des rayons du soleil et des températures au-dessus de 50°C. Ne pas ouvrir ou brûler de façon violente après utilisation. Ne pas vaporiser sur des flammes ou objets incandescents. Conserver à l'écart de toute flamme ou source d'étincelles. Ne pas fumer. À conserver hors de portée des enfants.

**Homologation :**

Les matières actives du neodisher®IP Spray sont enregistrées par la Food and Drug Administration (N°176210, 1771200 et 172878).

**Expertises :**

Nous disposons des expertises toxicologiques suivantes (GT 4304/1-84) :

- irritation primaire de la peau pour le lapin
- test d'irritation des yeux pour le lapin
- application par orale pour le rat.

Si vous avez un problème de lavage, de désinfection, de nettoyage,  
consultez-nous.

neodisher®  
votre partenaire,  
notre savoir-faire.

Les informations de cette fiche technique se basent sur nos connaissances et expériences actuelles. Elles ne sauraient dispenser l'utilisateur de ses propres contrôles et de se reporter à la législation en vigueur. Une assurance juridique de propriétés déterminées ne peut pas en être déduite.

## Rénover vos instruments



## Rénover vos instruments

### Landax 101

Référence : V78300

Produit spécial utilisé pour le traitement en profondeur et/ou par ultrasons des instruments chirurgicaux en inox.

#### Elimine :

Les colorations d'origine, oxydation à l'air et autres oxydations, restes d'albumine incrustés.

#### Principaux domaines d'applications :

- Traitement en profondeur et/ou par ultrasons d'instruments chirurgicaux en inox.
- Souvent, l'utilisation dans les stérilisateurs d'eau, et d'une vapeur d'eau dont les composants sont mal appropriés, des erreurs pendant le traitement, un nettoyage insuffisant et l'emploi de détergents et désinfectants mal adaptés, suffisent pour laisser apparaître sur les ustensiles des taches et des colorations correspondant à la corrosion. Souvent même, il se forme de la rouille, voire un grippage d'articulations.
- Dans de tels cas, il est formellement déconseillé d'effectuer un nettoyage en profondeur des instruments en les grattant avec des brosses métalliques, ou en pratiquant d'autres méthodes semblables qui pourraient abîmer la surface des instruments et favoriseraient une corrosion plus importante. Nous effectuerons alors un traitement chimique approprié en profondeur afin de permettre la formation naturelle de la couche de protection à la surface de l'instrument, dite couche de passivation.
- Il ne faut utiliser le traitement en profondeur que pour les instruments en acier inoxydable.
- Les instruments ayant des parties en alliage dur sont également appropriés pour un traitement en profondeur, si les restrictions citées dans le mode d'emploi par le fabricant sont respectées.
- Vérifier l'aptitude des instruments chirurgicaux en inox, dont la qualité n'est pas garantie par un essai sur échantillon.
- Effectuer un test préalable pour les parties en métal léger, pour vérifier qu'elles sont adéquates.
- Les bacs recevant le bain de trempage pour un traitement approfondi des instruments, doivent résister à l'acide. Il faut également veiller à ce que les canalisations par lesquelles la solution de LANDAX 101 sera évacuée, soient en matière résistante à l'acide. En effet, ce produit est à base d'acide.
- Le traitement en profondeur avec le LANDAX 101 ne doit pas être confondu avec le premier nettoyage des instruments neufs
- Afin d'éviter le renouvellement de taches et de colorations, vérifier chaque étape de l'utilisation, du nettoyage et de la désinfection mécanique et/ou manuelle, ainsi que la stérilisation. Il est très important de vérifier la qualité de l'eau et la vapeur destinées aux différentes étapes du traitement des instruments.



**Mode d'emploi :**

Traitement en profondeur : toujours sous surveillance.

Placer les instruments en inox présentant des taches et des colorations dans une solution de 1-10 % de LANDAX 101 chauffée à 50° C maximum. Si possible, on pourra réserver un bac à ultra-sons à cet usage, ou alors bien rincer avec précaution à la fin de l'intervention. Pour les instruments à mors ou tranchants en carbure de tungstène (anneaux dorés) réduire la concentration à 1- 3 %, un dosage plus élevé peut engendrer une modification de la couleur des plaquettes (noircissement) qui n'a absolument aucune conséquence sur la structure de ce matériau. Retirer les instruments dès que les colorations ont disparu, les rincer soigneusement et abondamment à l'eau de ville puis à l'eau adoucie, puis sécher.

Procéder aux étapes suivantes pour les instruments ayant maintenant un aspect parfait.

Si les taches et les colorations ne sont pas encore parfaitement éliminées (ceci peut être le cas d'attaques très anciennes) recommencer le traitement.

Il est également possible d'augmenter le temps d'action jusqu'à 4 heures. En revanche, les instruments ne doivent en aucun cas rester 24h sans contrôle dans les solutions.

Si après ce traitement par trempage, les colorations « marrons », « grises » etc. n'ont pas disparu, contacter notre Service Technique qui agira pour l'éliminer. Dans tous les cas, essayer de déterminer les causes pour les supprimer le plus vite possible. Proscrire un traitement avec des brosses métalliques, car les surfaces en inox sont irréversiblement abîmées. Chaque rayure devient le point de départ d'une attaque corrosive !

Effectuer un traitement par ultrasons, soit régulièrement (1 fois par an) pendant les lavages quotidiens, soit uniquement pour les dépôts résistants et « desséchés ».

Dans les bacs à ultrasons situés dans les machines à cycles, le LANDAX 101 est utilisé à une concentration de 2 – 4 ml/l à 50° C maximum.

Dans les cuves à ultrasons séparées pour un nettoyage sporadique, le LANDAX 101 peut être utilisé à une concentration de 15 – 35 ml/l à 50° C maximum.

Le temps d'action est de 1 à 5 minutes selon les données constructeur. Rincer totalement la solution d'utilisation de LANDAX 101.

Pour votre meilleur service, notre Responsable Régional se tient à votre disposition et vous conseillera utilement.

**Informations techniques :**

Tableau de dosage :

Solution d'utilisation Landax 101	1 %	5 %	10 %
2 litres	20 ml	100 ml	200 ml
5 litres	50 ml	150 ml	500 ml
10 litres	100 ml	500 ml	1000 ml
15 litres	150 ml	750 ml	1500 ml
20 litres	200 ml	1000 ml	2000 ml

Composants : (selon les normes européennes)

- < 5 % tensioactifs non ioniques
- 15 – 30 % phosphore inorganique (d'acide phosphorique)

Poids spécifique (20° C) : 1,4 g/cm<sup>3</sup>

Valeur pH (déterminée en eau déminéralisée, 20° C) à 1, à 10 % : 1,8 à 0,9

Viscosité (Concentré, 20° C) : < 50 mPas

Facteur de titrage : 0,19 (selon l'échelle de titrage LANDAX 101).

Biodégradabilité : Jusqu'à 90 %.

Conditions de stockage : 4 ans (craint le gel à partir de – 15° C).

Conditionnement : Bidon de 1 litre

**Indications de risque et conseil de sécurité :**

- Corrosif
- Acide phosphorique - 25 %
- R34 : Provoque de graves brûlures.

**CONSEILS DE SECURITE :**

- S22 Tenir hors de portée des enfants.
- S26 En cas de projection dans les yeux, rincer abondamment avec de l'eau et consulter un ophtalmologiste.
- S27 Oter immédiatement les vêtements imbibés.
- S28 En cas de contact avec la peau, rincer abondamment avec de l'eau.
- S37/39 Au cours de la manipulation, porter des gants de protection appropriés, des lunettes et un masque de protection du visage.
- S45 En cas d'accident ou de malaise, consulter immédiatement un médecin (si possible lui montrer cette fiche technique).

NOUS GARANTISSONS LA QUALITE ET L'EFFICACITE DE NOTRE PRODUIT DANS LES CONDITIONS D'UTILISATION FIGURANT SUR LA PRESENTE NOTICE. POUR VOTRE PLUS GRANDE SATISFACTION NOUS VOUS RECOMMANDONS DE PROCEDER TOUJOURS A UN ESSAI PREALABLE AFIN DE VOUS ASSURER QUE LE PRODUIT CONVIENT A L'USAGE SPECIFIQUE QUE VOUS VOULEZ EN FAIRE ET AU SUPPORT SUR LEQUEL IL DOIT ETRE APPLIQUE.

## Procédure d'inactivation des ATCN



## Procédure d'inactivation des ATCN

Nous vous conseillons LES DESINFECTANTS A BASE D'ENZYMES PROTEOLYTIQUES OU ACIDE PERACETIQUE

### Procédure d'inactivation des A.T.N.C. à la SOUDE 1N

Application de la procédure du Groupe 4 (procédé d'efficacité maximale-procédure combinée chimique et physique) de la circulaire du 14 Mars 2001.

#### 1 – Pré-désinfection

Voir nos conseils ci-après. Après protection adaptée du manipulateur :

- Préparer le bain de pré-désinfection (en respectant scrupuleusement le dosage recommandé par le laboratoire)
- Immerger totalement le panier contenant tous les instruments dans le bain en respectant le temps de contact préconisé (en règle générale 15 minutes – temps de contact décompté au minuteur).

#### 2 – Rincer

- Soigneusement à la douchette l'ensemble des instruments dans le panier.

#### 3 – Inactivation chimique

- Mettre lunettes, gants de protection, tablier.
- Verser 1 bidon de 5 litres de soude 1N prêt à l'emploi dans un bac de trempage prévu à cet effet.
- Immerger totalement le panier et ses instruments.
- Laisser en contact pendant 1 heure (temps de contact précisément décompté au minuteur)
- Sortir le panier d'instruments.
- Utiliser un gélifiant ou vider le bain après neutralisation par acide chlorhydrique 1N, si les canalisations d'évacuation le permettent.

#### 4 – Lavage et séchage

- Procéder à un cycle complet de lavage et séchage du panier et de ses instruments. Selon les cas, le lavage sera conseillé ou obligatoirement manuel.

#### 5 – Conditionnement

- Faire un contrôle visuel des instruments.
- Eliminer et remplacer tout instrument qui aurait subi une modification d'aspect ou de fonctionnalité – la corrosion peut s'exprimer par un grippage d'articulation –.
- Placer le panier dans le conteneur.

#### 6 – Inactivation physique

- Placer le conteneur en autoclave
- Lancer un cycle « instrumentation 134°C - 18 minutes »

#### 7 – A la sortie de l'autoclave

- Le conteneur et son contenu peuvent être stockés normalement. Une mise en quarantaine est possible selon les cas, voir protocole interne à chaque établissement.

**ATTENTION**

Avant l'inactivation chimique à la soude bien vérifier que le panier ne contient aucun instrument en aluminium ou alliage d'aluminium (écarteurs – valves – manches). En cas de doute, se renseigner auprès du fabricant ou éliminer l'instrument. Sinon, un risque de projection est possible sur le manipulateur.

Cette procédure retenue par l'A.P.H.P. (Assistance Publique des Hôpitaux de Paris) a été testée 20 fois consécutives avec succès sur tous les instruments LANDANGER dont la liste est jointe en annexe 1.



# Annexes



## Annexe 1

### LISTE DES INSTRUMENTS LANDANGER TESTÉS DANS LE CADRE DE L'ÉTUDE DE LA RÉSISTANCE LORS DE LA PROCÉDURE D'INACTIVATION DES A.T.N.C.

- 1 paire de ciseaux Mayo droit à vis lame plate 15 cm
- 1 pince Kocher BP droite à griffes 14 cm
- 1 pince en cœur 16 cm à doigt mors 19 mm
- 1 porte aiguille Crile-Wood 15cm mors tungstène
- 1 paire de ciseaux Metzenbaum courbe 15 cm tungstène
- 1 paire de ciseaux burin Farabeuf manche lourd 25 cm 10 mm
- 1 paire d'écarteurs Farabeuf 11x15 mm 15 cm
- 1 écarteur Lange Hohmann manche ajouré 26 cm 24 mm
- 1 pointe carrée ombredanne 3 mm 22 cm
- 1 trocart Monod diamètre 8 mm
- 1 pince dissection 14 cm avec griffes
- 1 pince électro-coagulation garnie téflon 18 cm à griffes sans embout
- 1 pince dissection Adson 12 cm mors tungstène largeur 1,6 mm
- 1 poignée composite seule « confort Rudolf » sans crémaillère sans ressort pour instruments
- 1 tube isolé diamètre 5 mm 330 mm
- 1 insert pour pince Taccoen, 2 mors mobiles diamètre 5 mm 330 mm
- 1 chemise de trocart avec valve en silicone robinet et tube en PEEK diamètre 11 mm
- 1 trocart automatique à clapet avec robinet complet avec pointe pyramidale diamètre 7 mm
- 1 panier grillage inox 515x245x60mm



## Annexe 2

Liens utiles :

Site internet de l'Afnor :  
[www.afnor.fr](http://www.afnor.fr)

Site internet de l'Aki :  
[www.a-k-i.org](http://www.a-k-i.org)

Site internet du Snitem :  
[www.snitem.fr](http://www.snitem.fr)

Site internet de l'Association Française de Stérilisation :  
[www.afs.asso.fr](http://www.afs.asso.fr)

Site internet d'Hygienosa :  
[www.hygienosa.com](http://www.hygienosa.com)

### Annexe 3

#### Compatibilité du matériel vis à vis des procédés d'inactivation des ATCN

Produits Instruments de chirurgie	Stérilisation 134°C >18 minutes	Soude 1N 1 heure	Javel 6° Cl 1 heure	Remarques
• Acier inox	Oui	Oui (1)	Non	(1)
• Acier inox + pastilles tungstène	Oui	Oui (1)	Non	(1)
• Alliage de titane	Oui	Oui (1)	Non	(1)
• Alliage d'aluminium	Oui	Non (2)	Non	(2)
• Matière plastique polyacétal (delrin P.O.M.)	Oui (3)	Oui	Non	Vieillissement prématuré Risque de déformation si température élevée
• Matière plastique (téflon)	Oui	Oui	Non	/
• Manche céleron	Oui	Non	Non	/
• Écarteur et valves en werwynil noir (réf. : B80822A)	Oui (4)	Non	Non	(4)

## Annexe 4

### Les 18 recommandations de base du guide AFNOR pour la pré-désinfection, le nettoyage et la stérilisation des instruments de chirurgie

Veiller scrupuleusement à :

- |   |   |
|---|---|
| <p><b>1/</b> Manipuler les instruments avec soin tout au long des différentes phases des traitements,</p> <p><b>2/</b> Nettoyer les instruments neufs avant la première utilisation,</p> <p><b>3/</b> Traiter à part les instruments de microchirurgie,</p> <p><b>4/</b> Essuyer minutieusement les instruments en contact avec des produits corrosifs,</p> <p><b>5/</b> Respecter le mode d'emploi fourni par les fabricants d'équipement, machines à laver, machines à ultrasons, stérilisateurs,</p> <p><b>6/</b> Respecter la concentration et le temps retenus parmi les valeurs ayant prouvé leur efficacité pour les produits de pré-désinfection, de nettoyage et de lubrification,</p> <p><b>7/</b> Tremper le plus rapidement possible les instruments souillés par des matières organiques uniquement dans des solutions pré-désinfectantes,</p> <p><b>8/</b> Positionner correctement, sans surcharge, les instruments de façon à éviter les zones d'ombre,</p> | <p><b>9/</b> Ouvrir les instruments articulés pour la pré-désinfection et le nettoyage,</p> <p><b>10/</b> Proscrire l'utilisation de brosses métalliques et de tampons à récurer,</p> <p><b>11/</b> Rincer minutieusement à l'eau après la pré-désinfection et le nettoyage,</p> <p><b>12/</b> Procéder au contrôle de propreté et de bon fonctionnement des instruments,</p> <p><b>13/</b> Trier et retirer du circuit les instruments tachés et détériorés,</p> <p><b>14/</b> Appliquer sur les instruments des produits lubrifiants, si nécessaire,</p> <p><b>15/</b> Ne fermer qu'au premier cran les instruments à encoches et crémaillères pour la stérilisation,</p> <p><b>16/</b> Choisir le conditionnement adapté aux instruments pour la stérilisation,</p> <p><b>17/</b> Ne pas réutiliser ni restériliser les articles à usage unique (non réutilisables),</p> <p><b>18/</b> La stérilisation ne remplace pas la pré-désinfection ni le nettoyage. On ne stérilise bien que ce qui est propre.</p> |
|---|---|











**LANDANGER**

technologie pour la santé