

MUSEUX

Droite
Straight
Recta

14 cm - 5 1/2"

F10340

16 cm - 6 1/4"

F10350



18 cm - 7"

F10360



F10350
16 cm - 6 1/4"



F10360
18 cm - 7"

MUSEUX

Courbe latérale
Lateral curved
Curva lateral

4 griffes
4 teeth
4 dientes



F10380
7 mm



F103801
7 mm

F10390
9 mm



F103901 
9 mm

 **F10400**
11 mm

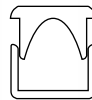

F104001
11 mm

6 griffes
6 teeth
6 dientes

F104100
11 mm



F10400
24 cm - 9 1/2"

F103901
24 cm - 9 1/2"

MUSEUX PALMER-CHERON

MUSEUX PALMER



F10420
23 cm - 9"



F10450
24 cm - 9 1/2"

TEALE

IOWA

JACOBS

Courbe latérale
Lateral curved
Curva lateral



6 mm

Pour la vésicule amniotique
For the amnion bladder
Para la vesícula amniótica

Double courbure
Double curvature
Doble curvatura



6 mm



6 mm



F10517
26 cm - 10 1/4 "



F105175
26 cm - 10 1/4 "



F105185
21 cm - 8 1/4 "

Pinces utérines à polypes - Uterines polypus forceps - Pinzas uterinas para polipos

MATHIEU

PALMER

Pinces à polypes
Polypus forceps
Pinzas para polipos

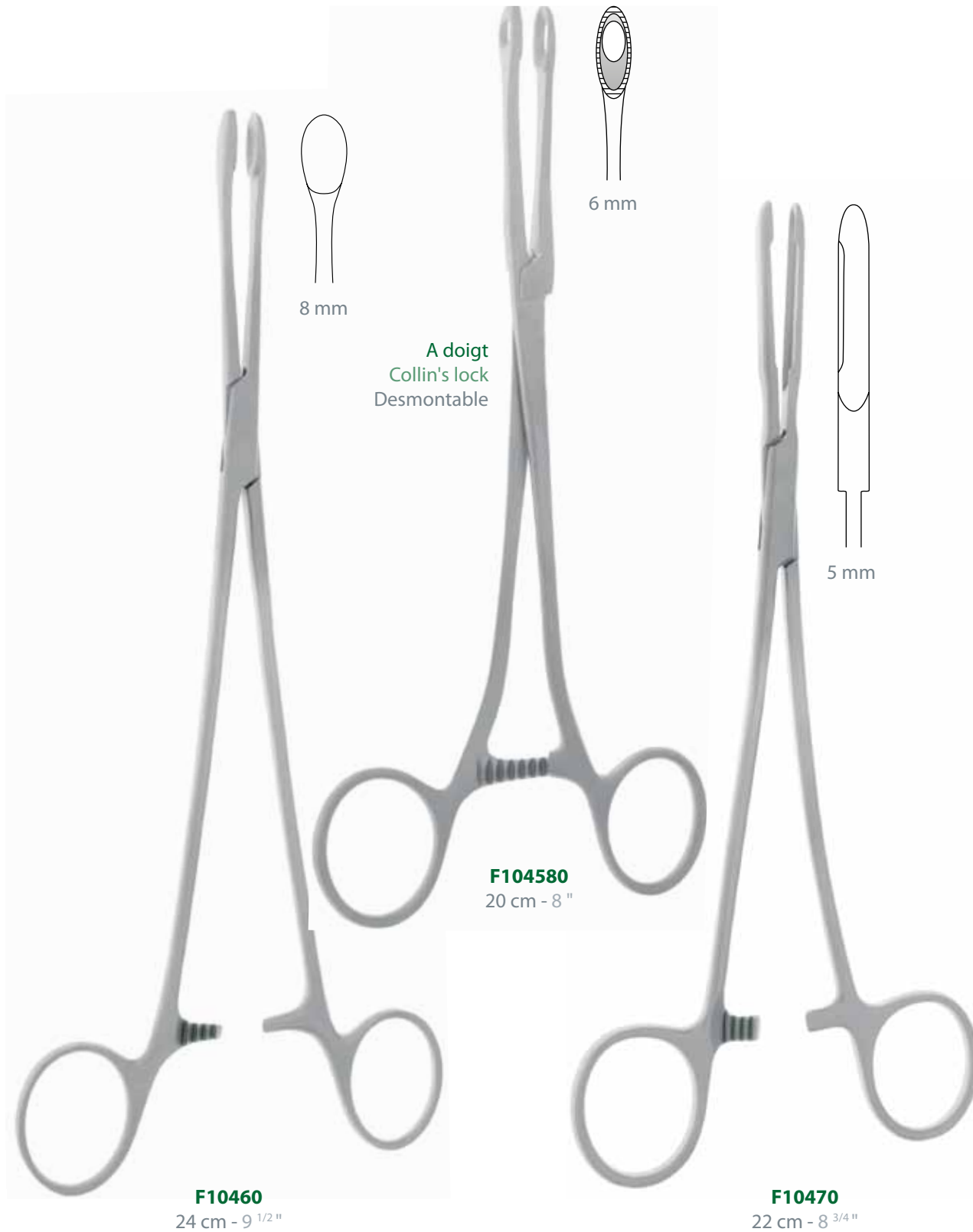

F10460
24 cm - 9 1/2 "

F104580
20 cm - 8 "

F10470
22 cm - 8 3/4 "

A doigt
Collin's lock
Desmontable

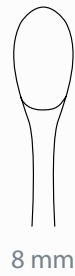

8 mm



6 mm



5 mm

POZZI PALMER

POZZI



F10480
23 cm - 9 "



F10505
18 cm - 7 "



F10515
24 cm - 9 1/2 "

COLLIN POZZI

SCHROEDER

DUPLAY



A vis
With screw
Con tornillo

F105151
25 cm - 10 "



F105152
25 cm - 10 "



Double courbure
Double curvature
Doble curvatura

F105153
28 cm - 11 "



SCHROEDER



F105155
25 cm - 10"

F10516
25 cm - 10"

F105165
25 cm - 10"

JL FAURE

Modèle léger
Light model
Modelo ligero

Modèle fort
Strong model
Modelo pesado



A griffes
With teeth
Con dientes

Sans griffes
Without teeth
Sin dientes

WERTHEIM

DARGENT

Dissecteur
Dissector
Disector

1/2 Courbe
1/2 Courbe
1/2 Courbe

Courbe
Courbe
Courbe

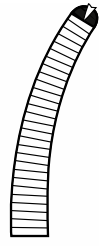
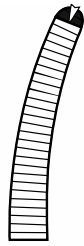

F105970

F105971



F105970
22 cm - 8 3/4 "



F105450
20 cm - 8 "

JL FAURE

A plateaux
With plates
Con platos



F10580
22 cm - 8 3/4"

A ligament large
For wide ligament
Para ligamento ancho

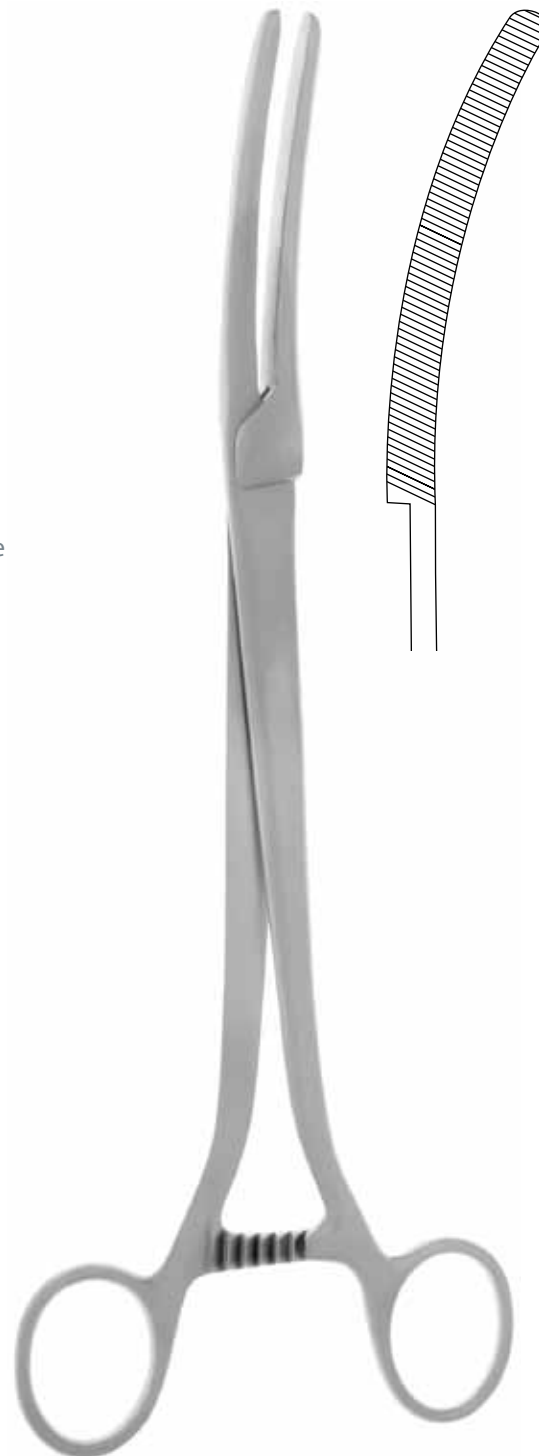

F10590
25 cm - 10"

A doigt
Collin's lock
Desmontable

ROGERS

	Droite Straight Recta	1/2 Courbe 1/2 Curved 1/2 Curva	Courbe Curved Curva	Coudée Angular Angulada			
22,5 cm - 8 ³ / ₄ "	F105910	22 cm - 8 ¹ / ₂ "	F105911	21,5 cm - 8 ¹ / ₂ "	F105912	20,5 cm - 8 "	F105913
25 cm - 10 "	F105920	24,5 cm - 9 ² / ₃ "	F105921 	24 cm - 9 ¹ / ₂ "	F105922	23 cm - 9 "	F105923

Mors atraumatique
Atraumatic jaws
Bocas atraumáticas



F105921
24,5 cm - 9 ²/₃ "

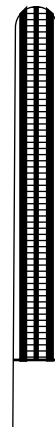

F105920
25 cm - 10 "

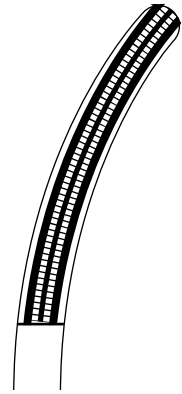

F105921
24,5 cm - 9 ³/₄ "

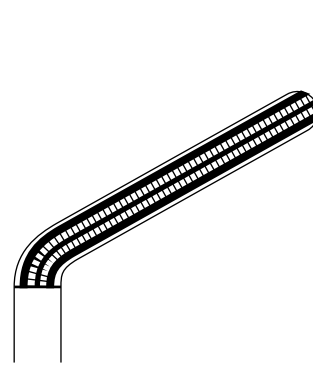

F105923
23 cm - 9 "

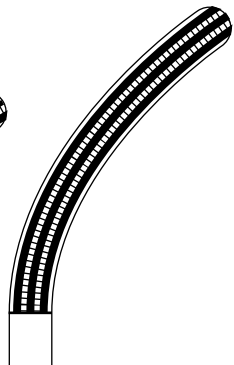

F105922
24 cm - 9 ¹/₂ "

Pinces utérines - Uterines forceps - Pinzas uterinas

HEANEY

2 dents
2 teeth
2 dientes



F105930 19,5 cm - 7 1/2"

F105932 21 cm - 8 1/4"

F105934 23 cm - 9"

SEGOND-LANDAU

1 dent
1 tooth
1 diente

F105931

F105933

F105935

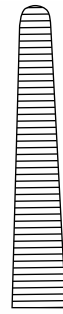

A vis
With screw
Con tornillo

SEGOND

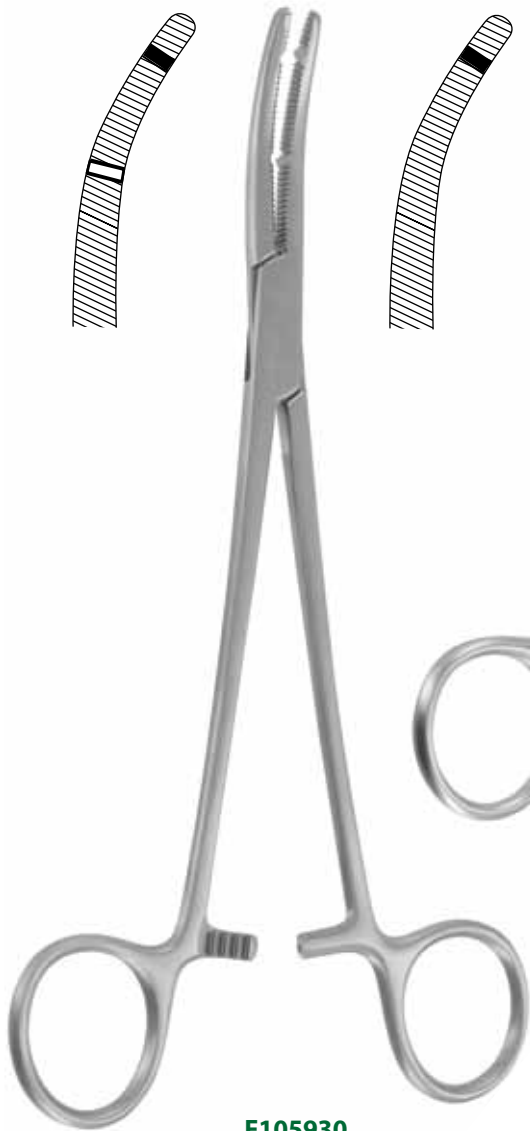
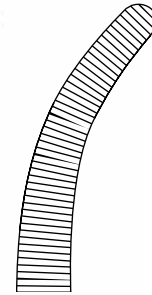

F105930
19,5 cm - 7 1/2"

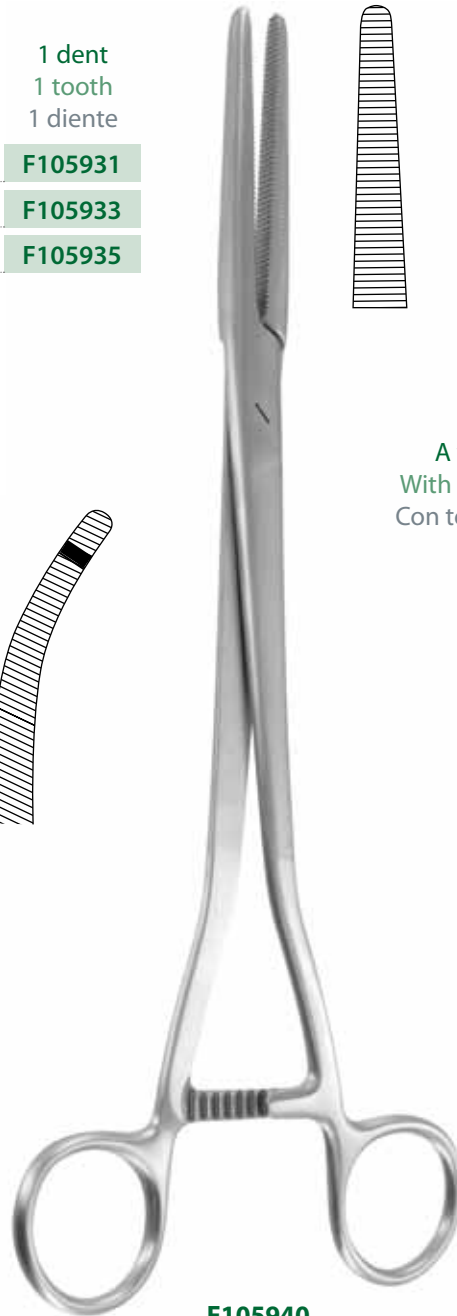

F105940
24 cm - 9 1/2"



F105941
24 cm - 9 1/2"

WERTHEIM



A vis
With screw
Con tornillo

F105980
24 cm - 9 1/2 "

F105981
25 cm - 10 "

Pinces utérines - Uterines forceps - Pinzas uterinas

MAINGOT

Courbe
Curved
Curva

20,5 cm - 8"

F105946



25 cm - 10"

F105945

HOLZBACH

Droite
Straight
Recta

Courbe
Curved
Curva

23,5 cm - 9^{1/4}"



F105948

F105949

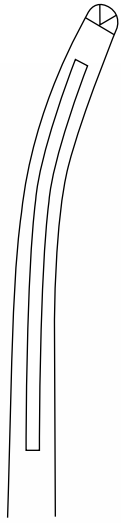

F105945

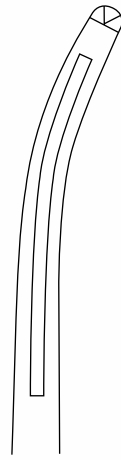

F105946

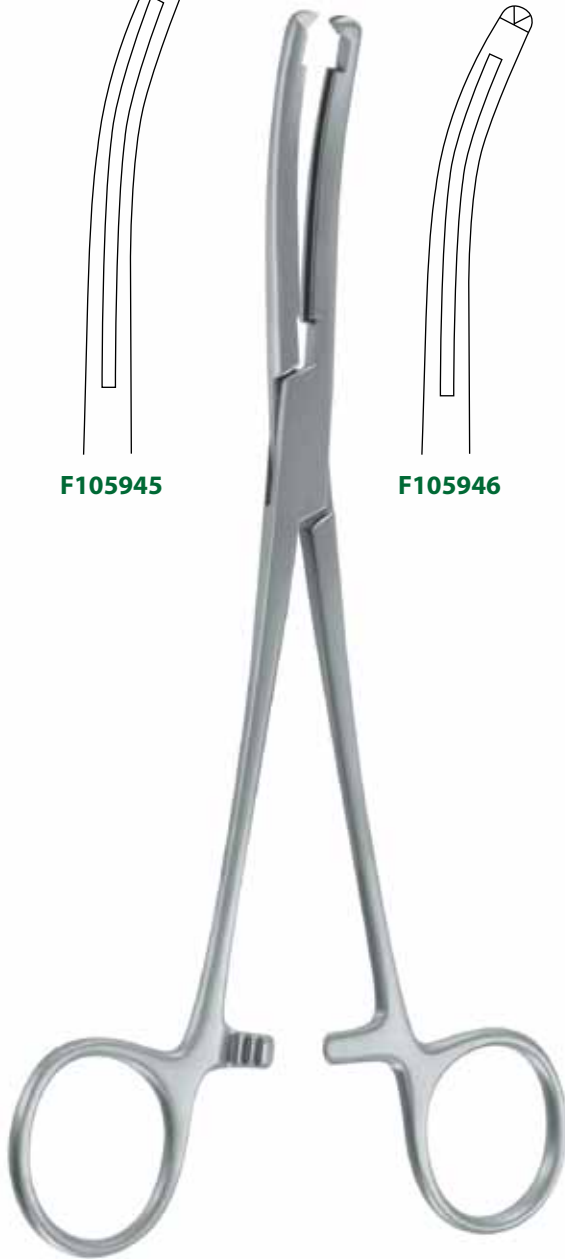
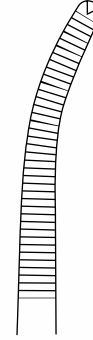

F105946
20,5 cm - 8"



F105948
23,5 cm - 9^{1/4}"

Pinces utérines - Uterines forceps - Pinzas uterinas

PHANEUF

Droite
Straight
Recta

Coudée
Angular
Angulada

21,5 cm - 8 1/2"

F105950



F105951

BALLENTINE

Droite
Straight
Recta

Courbe
Curved
Curva



F105955

21 cm - 8 1/4"

F105956



F105950

21,5 cm - 8 1/2"



F105955

21 cm - 8 1/4"

WERTHEIM CULLEN



F105965
21,5 cm - 8 1/2 "

F105961
23 cm - 9 "

Pinces utérines - Uterines forceps - Pinzas uterinas

COTT (À LAMBEAUX)

Mors
Jaws
Bocas

22,5 cm - 8 ³/₄ " **F106040** 4,5 mm
22 cm - 8 ²/₃ " **F10605** 6,0 mm 

3 x 3 griffes
3 x 3 teeth
3 x 3 dientes



F10605
22 cm - 8 ²/₃ "

CHROBAK

4 x 4 griffes
4 x 4 teeth
4 x 4 dientes



F106060
26 cm - 10 ¹/₄ "

Pinces utérines - Uterines forceps - Pinzas uterinas

PRATT



A vis
With screw
Con tornillo

F108180
28 cm - 11 "

BRAUN



F108190
15,5 cm - 6 1/4 "

CZERNY

20,5 cm - 8"

F108200

26 cm - 10 1/4"

F108205



F108205
26 cm - 10 1/4"

ROCHARD



F10610
21 cm - 8 1/4"

LEPAGE



Pince à faux germes
Ovum forceps
Pinza para aborto

A tenon
With tenon lock
Con tenon

F10630
27 cm - 10 1/2"

Pinces utérines - Uterines forceps - Pinzas uterinas

DOYEN

Pince à ovaire
Ovarian forceps
Pinza para ovarios

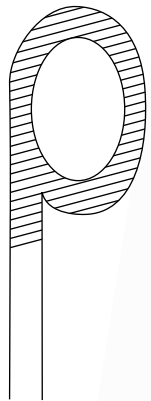

A vis
With screw
Con tornillo



F10620
24 cm - 9 1/2 "

BONNAIRE

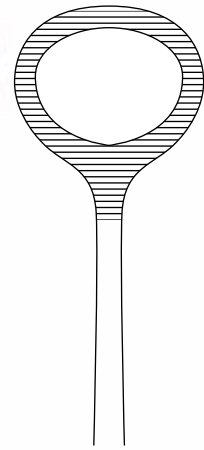

A tenon
With tenon lock
Con tenon



F106210
20 cm - 8 "

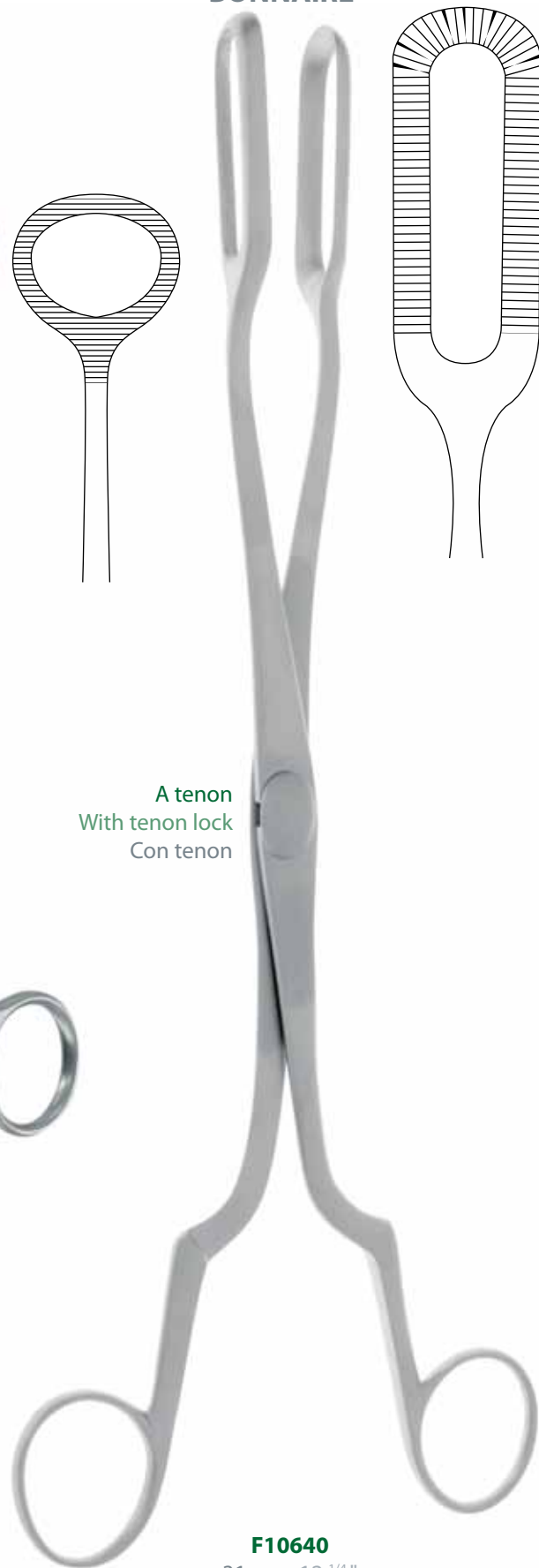
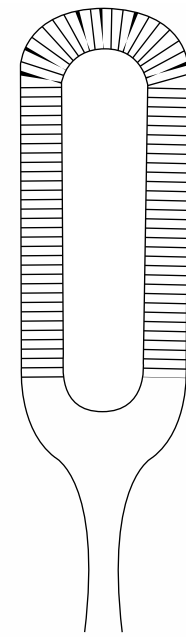

F10640
31 cm - 12 1/4 "



KELLY

HEYWOOD-SMITH

NOTO

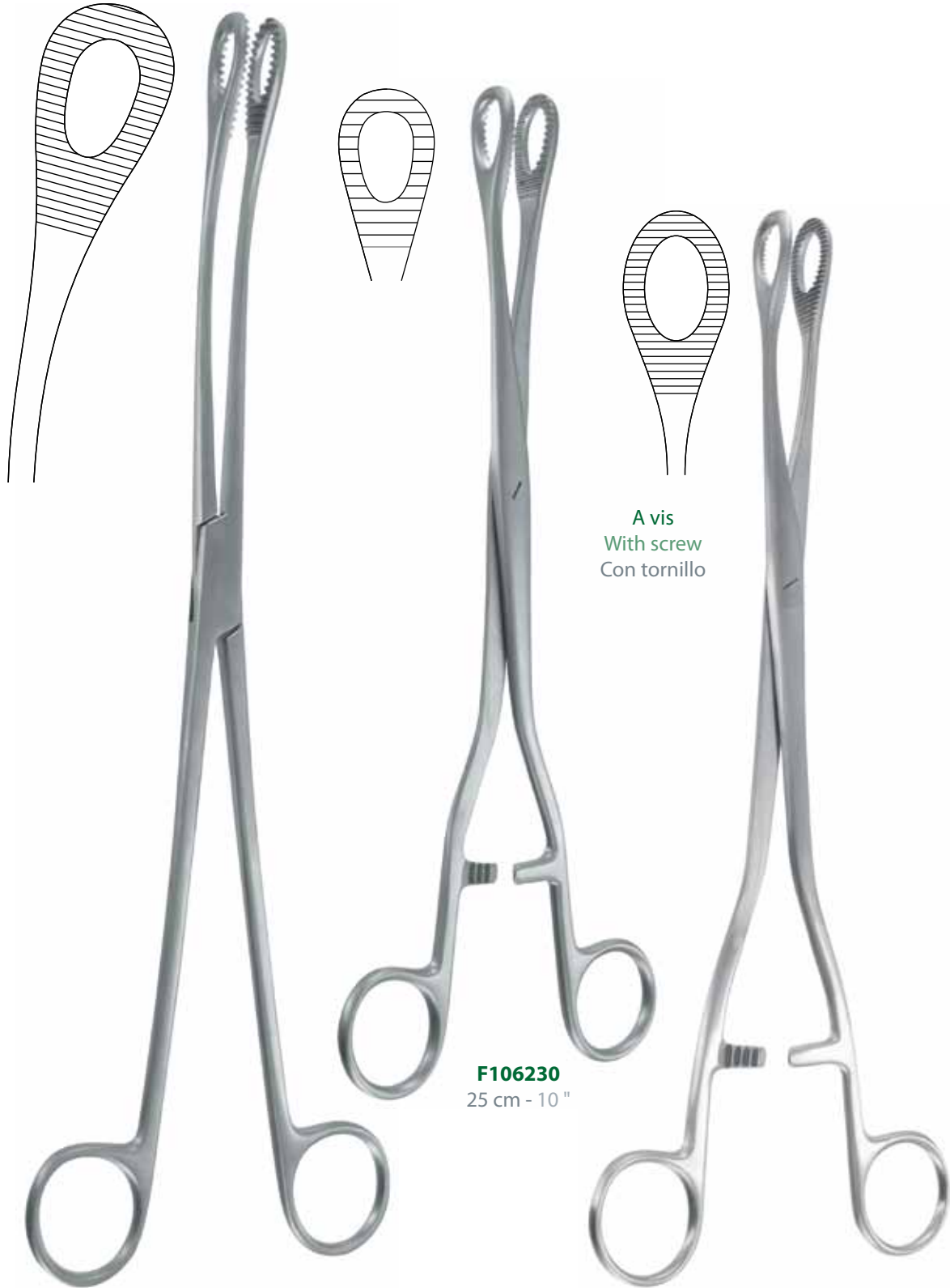

F106220

32 cm - 12 1/2 "

F106230

25 cm - 10 "

F106240

27 cm - 10 1/2 "

A vis
With screw
Con tornillo

Pinces utérines - Uterines forceps - Pinzas uterinas

Avec embout de protection
With protective cap
Con tapa protectora

WINTER

A vis
With screw
Con tornillo

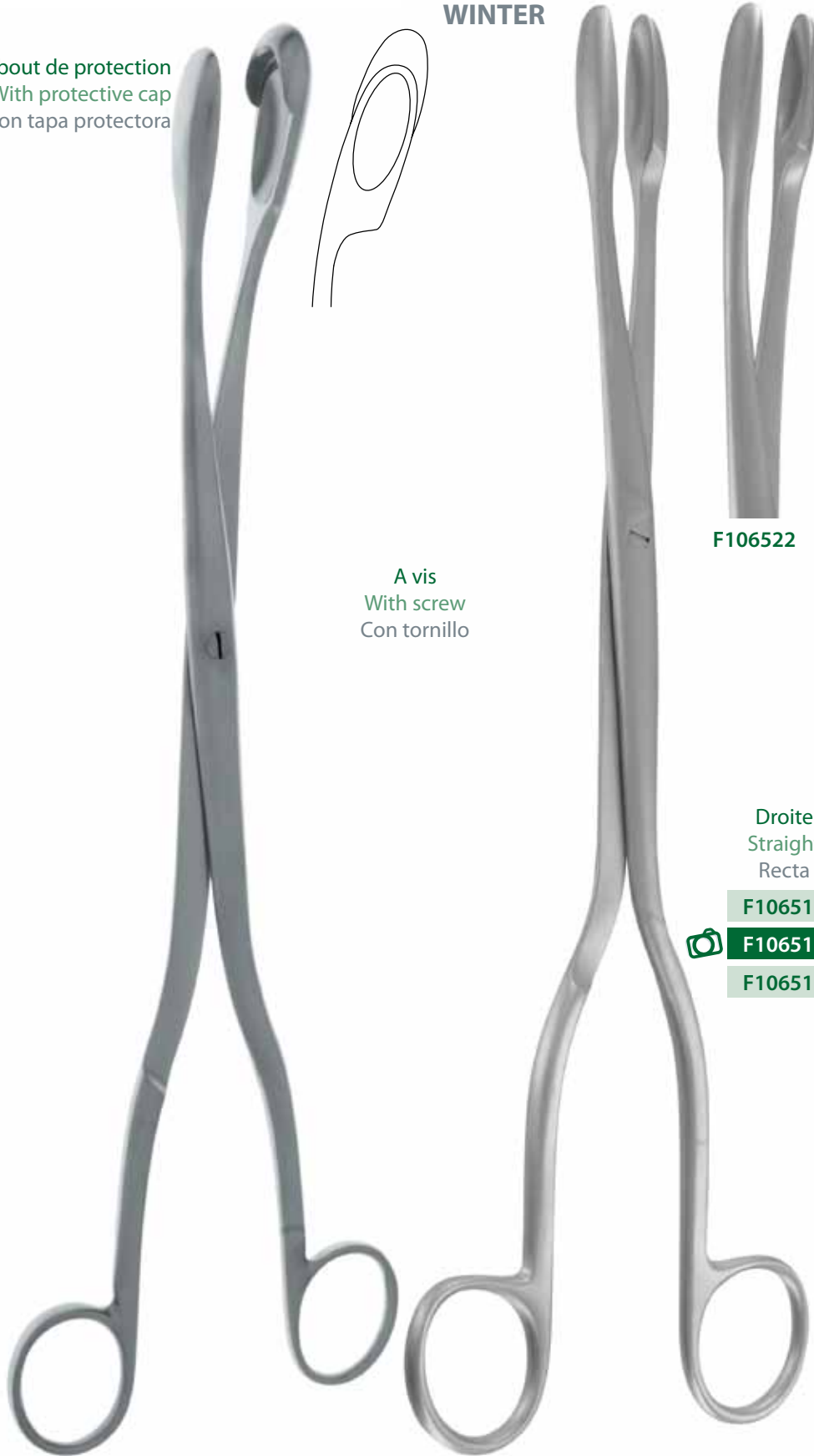

F106521

F106522

F106522

F106523

Droite
Straight
Recta

Courbe
Curved
Curva

F106511

9 mm

F106521



F106512

11 mm

F106522

F106513

14 mm

F106523

F10650

29 cm - 11 1/2 "

F106512

29 cm - 11 1/2 "

SAENGER

GREEN-ARMYTAGE

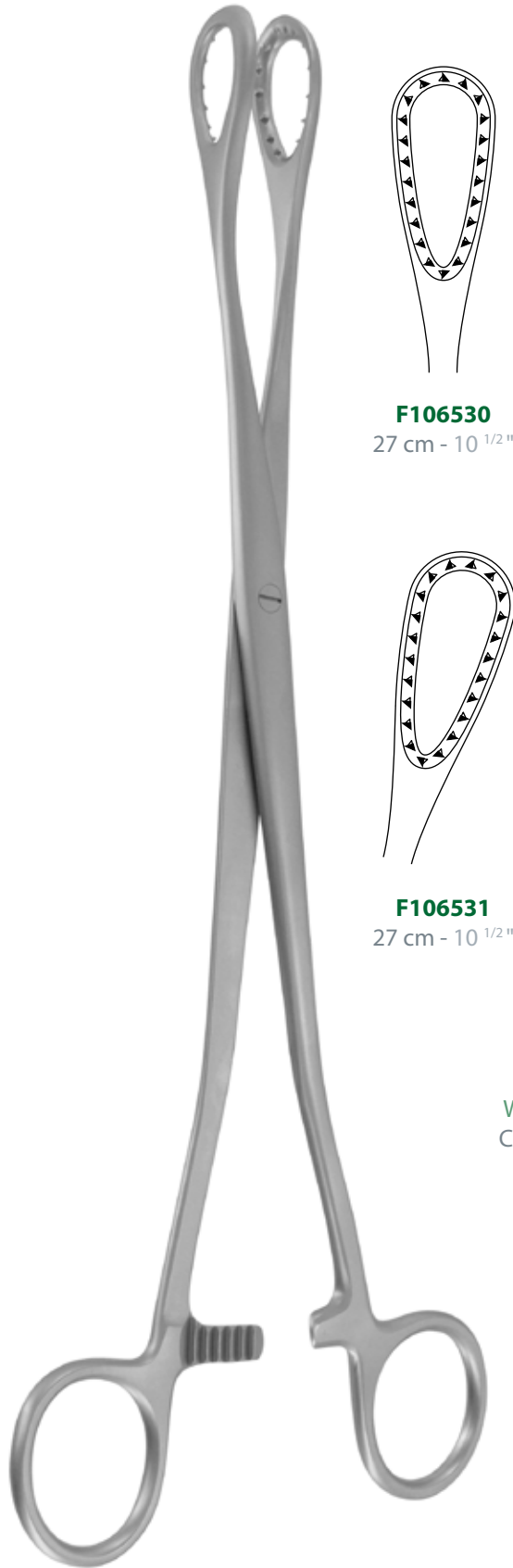

F106530

27 cm - 10 1/2"

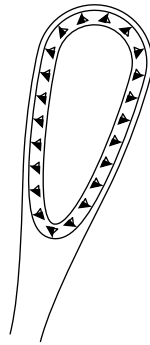

F106531

27 cm - 10 1/2"

A vis
With screw
Con tornillo

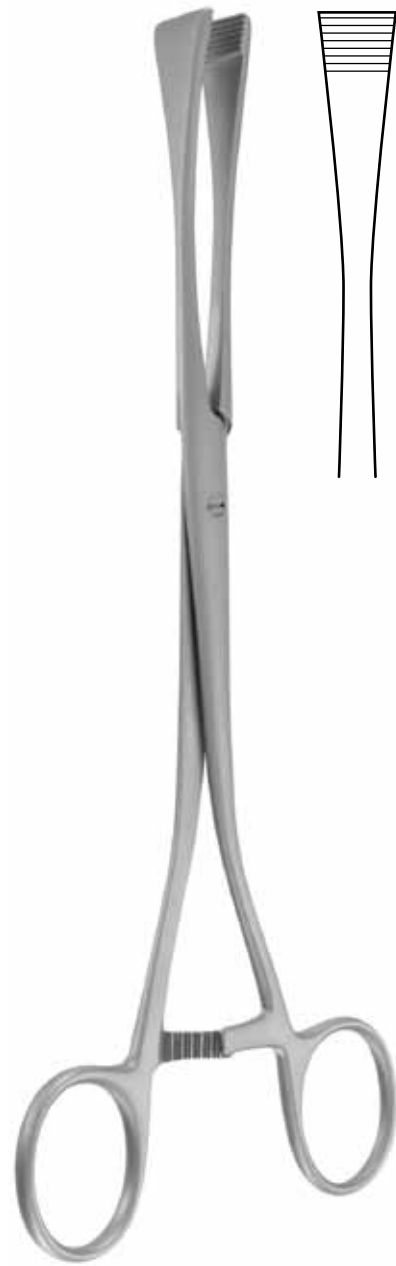

F106540

21 cm - 8 1/4"

F106530

27 cm - 10 1/2"

COLLIN

F16000	90 x 14 mm
F16010	90 x 16 mm
F16020	90 x 25 mm
F16030	90 x 30 mm
F16034	95 x 35 mm
F16038	105 x 30 mm
F16040	105 x 35 mm
F16050	105 x 38 mm
F16060	110 x 42 mm

Modèles avec tube d'aspiration
Models with aspiration tube
Modelos con tubo de aspiración

F18125	90 x 25 mm
F18130	90 x 30 mm
F18135	95 x 35 mm
F18230	105 x 30 mm
F18235	105 x 35 mm
F18240	110 x 42 mm

Modèle lourd
Heavy model
Fuerte modelo

F17016	100 x 16 mm
F17025	100 x 25 mm
F17030	100 x 30 mm
F17035	100 x 35 mm
F17040	100 x 40 mm

Longues valves
Long blades
Valvulas largas

F17130	150 x 30 mm
F17135	150 x 35 mm
F17140	150 x 40 mm



F16010

F18125

PALMER

F17165	65 x 35 mm
---------------	------------

F178000 Adaptation d'un tube d'aspiration sur un spéculum vaginal
Adaptation of one aspiration tube on a vaginal speculum
Adaptación de un tubo de aspiración sobre un espéculo vaginal

JAYLE

	F17630	100 x 30 mm
	F17634	100 x 34 mm
	F17638	100 x 38 mm

Longues valves

Long blades

Valvulas largas

F17734	150 x 34 mm
F17738	150 x 38 mm





F17630

F178000

Adaptation d'un tube d'aspiration sur un spéculum vaginal
 Adaptation of one aspiration tube on a vaginal speculum
 Adaptación de un tubo de aspiración sobre un espéculo vaginal

CUSCO

Pliant Pliable Plegable		Fixe Fixed Fijo	
F16070	100 x 16 mm	F16140	
F16080	100 x 25 mm	F16150	
F16090	100 x 28 mm	F16160 	
 F16100	100 x 30 mm	F16170	
F16110	100 x 35 mm	F16180	
F16120	100 x 37 mm	F16190	
F16130	100 x 40 mm	F16200	

SPÉCULUM POUR VIERGE VIRGIN SPECULA ESPÉCULO PARA VIRGEN

F16210	90 x 12 mm
F16220	90 x 14 mm
 F16230	90 x 16 mm
F16240	90 x 18 mm
F16250	90 x 20 mm



F16100

F16160

F16230

CUSCO

Spéculum pour vierge
Virgin specula
Espéculo para virgen

F163000 75 x 17 mm

F163001 75 x 32 mm

 **F163002** 85 x 35 mm

F163003 100 x 37 mm

GRAVE

F163011 75 x 20 mm

 **F163012** 95 x 30 mm

F163013 115 x 35 mm



LANDANGER

Spéculums vaginaux - Vaginal speculas - Espéculos vaginales

PEDERSON

F163031 75 x 13 mm

 F163032 100 x 22 mm

F163033 120 x 25 mm

SEYFFERT

F163021 100 x 17 mm

 F163022 110 x 33 mm

SEMM

F163041 90 x 14/18 mm

F163042 100 x 17/20 mm

 F163043 100 x 25/30 mm



F163032

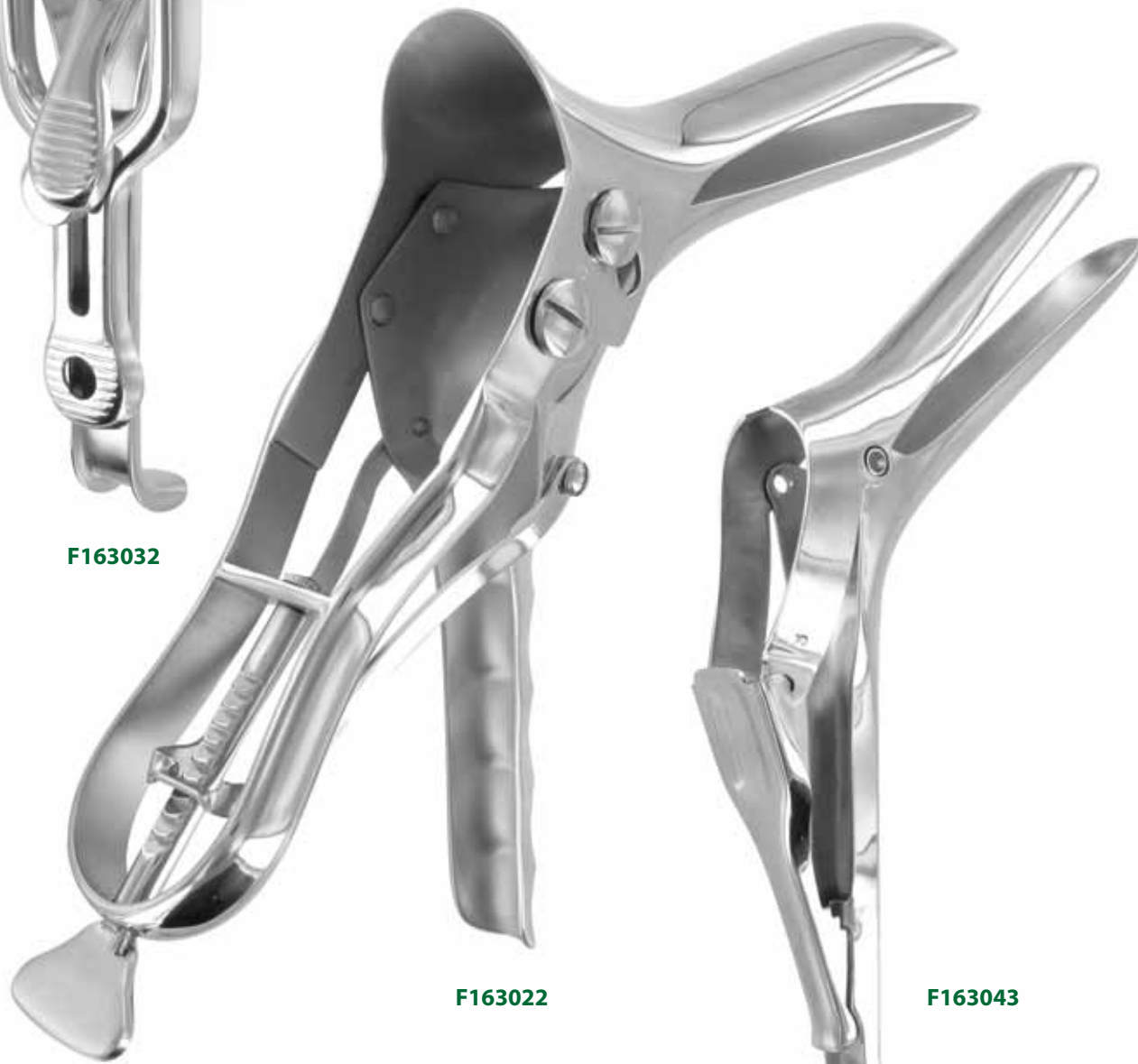

F163022



F163043

KOGAN





F190010
24 cm - 9 1/2"

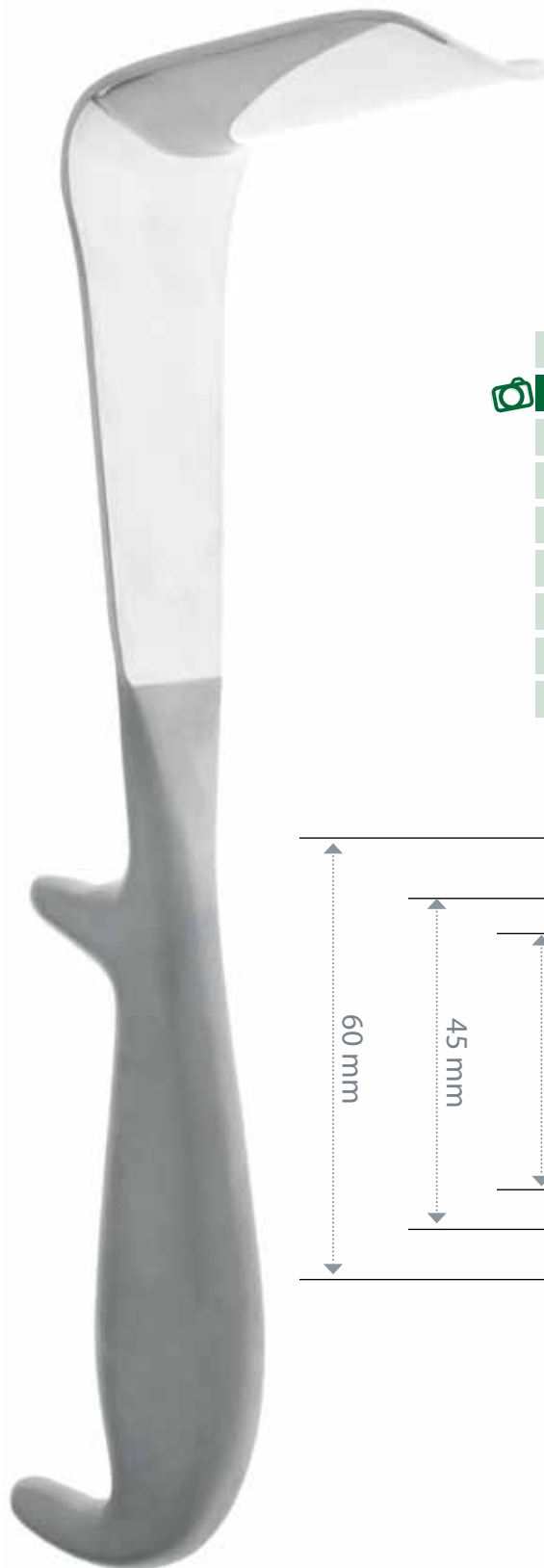

F190020
24 cm - 9 1/2"

DOYEN



	Profondeur Depth Profundidad	Largeur Width Anchura
F250280	60 mm	35 mm
 F25030	60 mm	45 mm
F25060	60 mm	60 mm
F25035	90 mm	35 mm
F25040	90 mm	45 mm
F25070	90 mm	60 mm
F250450	120 mm	35 mm
F25050	120 mm	45 mm
F25080	120 mm	60 mm

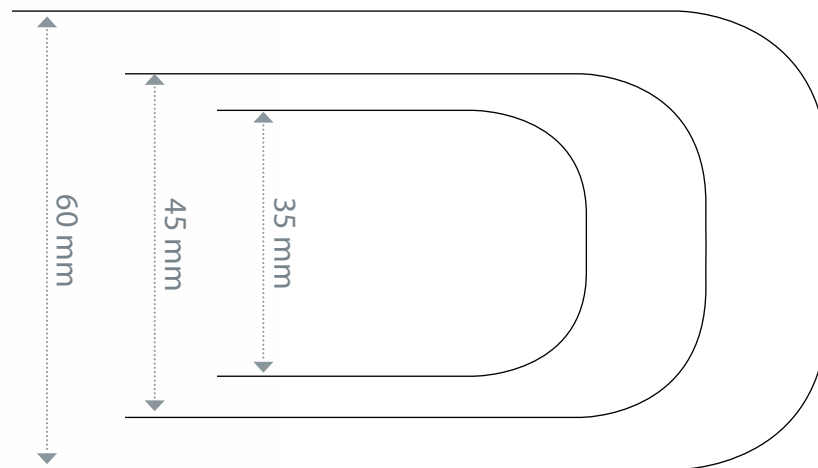

F25030
23 cm - 9 "

POUR INTERVENTION PAR VOIE VAGINALE
FOR OPERATION THROUGH VAGINAL TRACT
PARA INTERVENCIÓN POR VÍA VAGINAL



Valves vaginales - Vaginal blades - Valvas vaginales

POUR INTERVENTION PAR VOIE VAGINALE
FOR OPERATION THROUGH VAGINAL TRACT
PARA INTERVENCIÓN POR VÍA VAGINAL

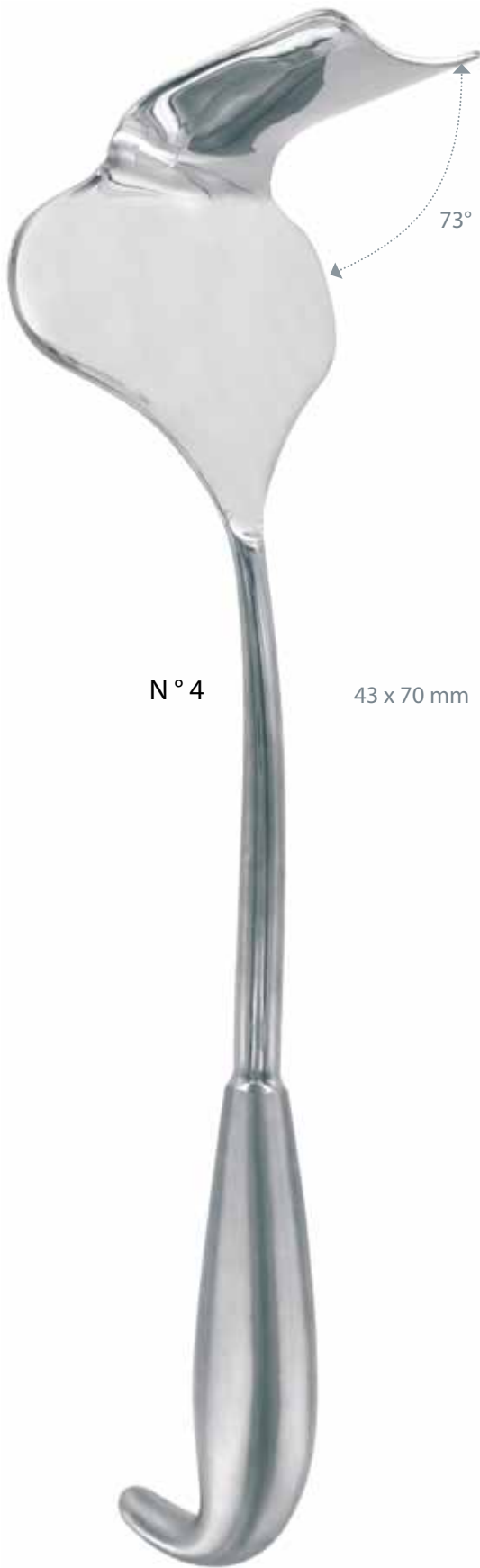

N° 4

43 x 70 mm

F25110

29 cm - 11 1/2"



N° 5

44 x 60 mm

F25115

23 cm - 9"

Valves vaginales - Vaginal blades - Valvas vaginales

Pour intervention par voie vaginale
For operation through vaginal tract
Para intervención por vía vaginal

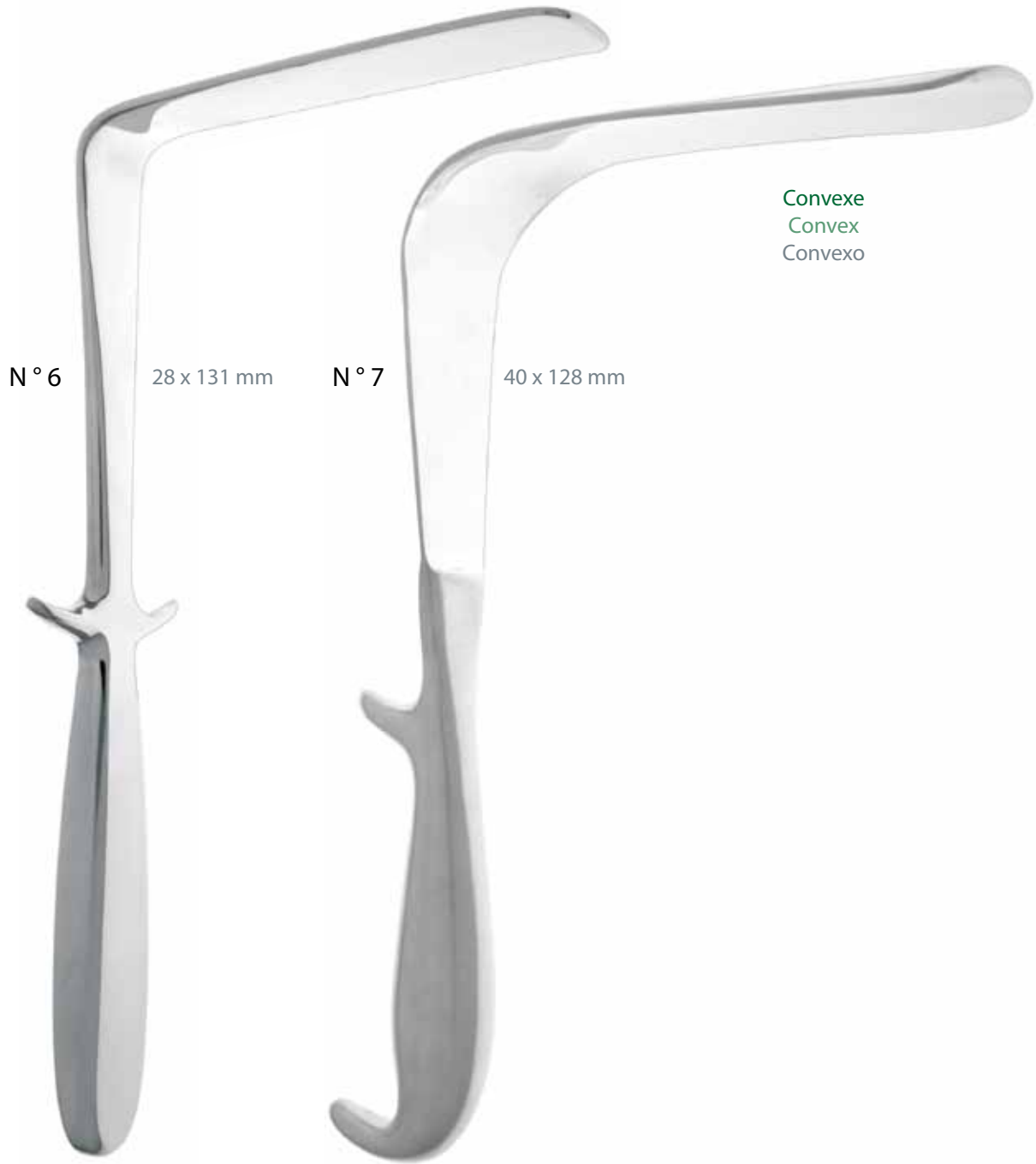
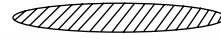

Convexe
Convex
Convexo

N° 6

28 x 131 mm

N° 7

40 x 128 mm

F25120

24 cm - 9 1/2 "

F25125

23 cm - 9 "

MANGIAGALLI

DOUGLAS



80 x 40 mm

F251280
19 cm - 7 1/2 "



100 x 42 mm

F251281
19 cm - 7 1/2 "



130 x 35 mm

F251290
19 cm - 7 1/2 "

DARGENT



Baïonette
Bayonet
Bayoneta

F260010
38 cm - 15"

			Largueur Width Anchura	Longueur Length Largo
--	--	--	------------------------------	-----------------------------

N° 1	38 cm - 15 "		F260010	40 mm	150 mm
N° 2	37 cm - 14 1/2 "		F260020	48 mm	135 mm
N° 3	35 cm - 13 3/4 "		F260030	50 mm	115 mm
N° 4	34 cm - 13 1/2 "		F260040	40 mm	115 mm
N° 5	33 cm - 13 "		F260050	38 mm	95 mm
N° 6	29 cm - 11 1/2 "		F260060	32 mm	90 mm
N° 7	28 cm - 11 "		F260070	28 mm	80 mm
N° 8	30 cm - 11 3/4 "		F260080	32 mm	90 mm
N° 9	30 cm - 11 3/4 "		F260090	30 mm	80 mm
N° 10	31 cm - 12 1/4 "		F260100	30 mm	85 mm
N° 11	31 cm - 12 1/4 "		F260110	22 mm	77 mm
N° 12	26 cm - 10 1/4 "		F260120	15 mm	70 mm

LANDANGER

Valves vaginales - Vaginal blades - Valvas vaginales

LANDAU

		Largeur Width Anchura	Longueur Length Largo
29 cm - 11 1/2" 	F251610	28 mm	100 mm
29 cm - 11 1/2"	F251615	38 mm	100 mm



F251610
29 cm - 11 1/2"

BRIESKY

		Largeur Width Anchura	Longueur Length Largo
27 cm - 10 3/4"	F251640	15 mm	70 mm
27,5 cm - 10 4/5"	F251720	28 mm	80 mm
28 cm - 11"	F251770	32 mm	90 mm
29 cm - 11 1/2"	F251645	20 mm	100 mm
29 cm - 11 1/2"	F251690	25 mm	100 mm
29 cm - 11 1/2"	F251740	30 mm	100 mm
29 cm - 11 1/2"	F251790	35 mm	100 mm
29 cm - 11 1/2"	F251840	40 mm	100 mm
32 cm - 12 1/2"	F25165	20 mm	130 mm
32 cm - 12 1/2"	F25170	25 mm	130 mm
32 cm - 12 1/2"	F25175	30 mm	130 mm
32 cm - 12 1/2"	F25180	35 mm	130 mm
32 cm - 12 1/2"	F25185	40 mm	130 mm
34 cm - 13 1/2"	F251900	40 mm	150 mm
37 cm - 14 1/2" 	F251950	40 mm	180 mm



F251950
37 cm - 14 1/2"

JACKSON

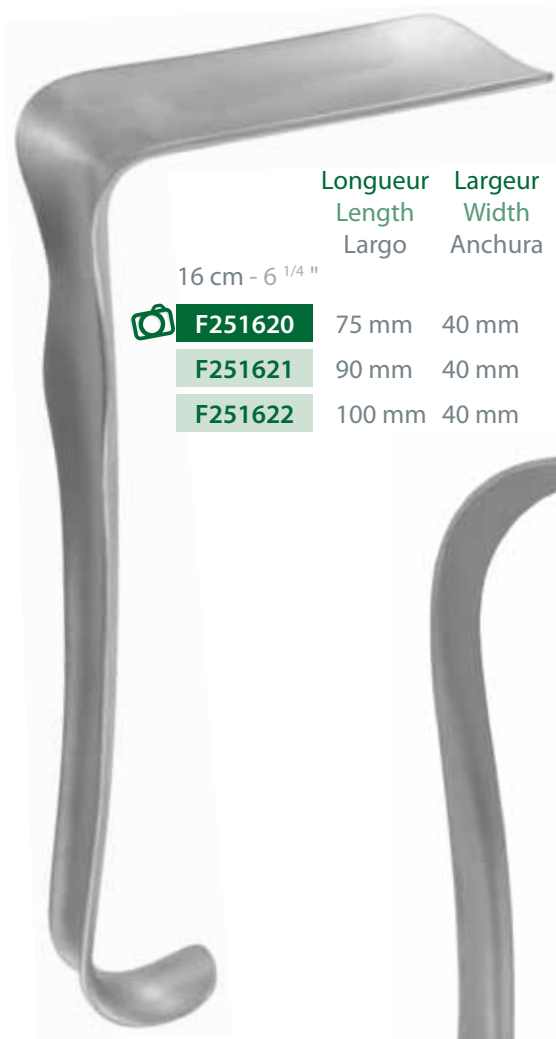

	Longueur Length Largo	Largeur Width Anchura
16 cm - 6 1/4 "		
 F251620	75 mm	40 mm
F251621	90 mm	40 mm
F251622	100 mm	40 mm

F251620

KRISTELLER

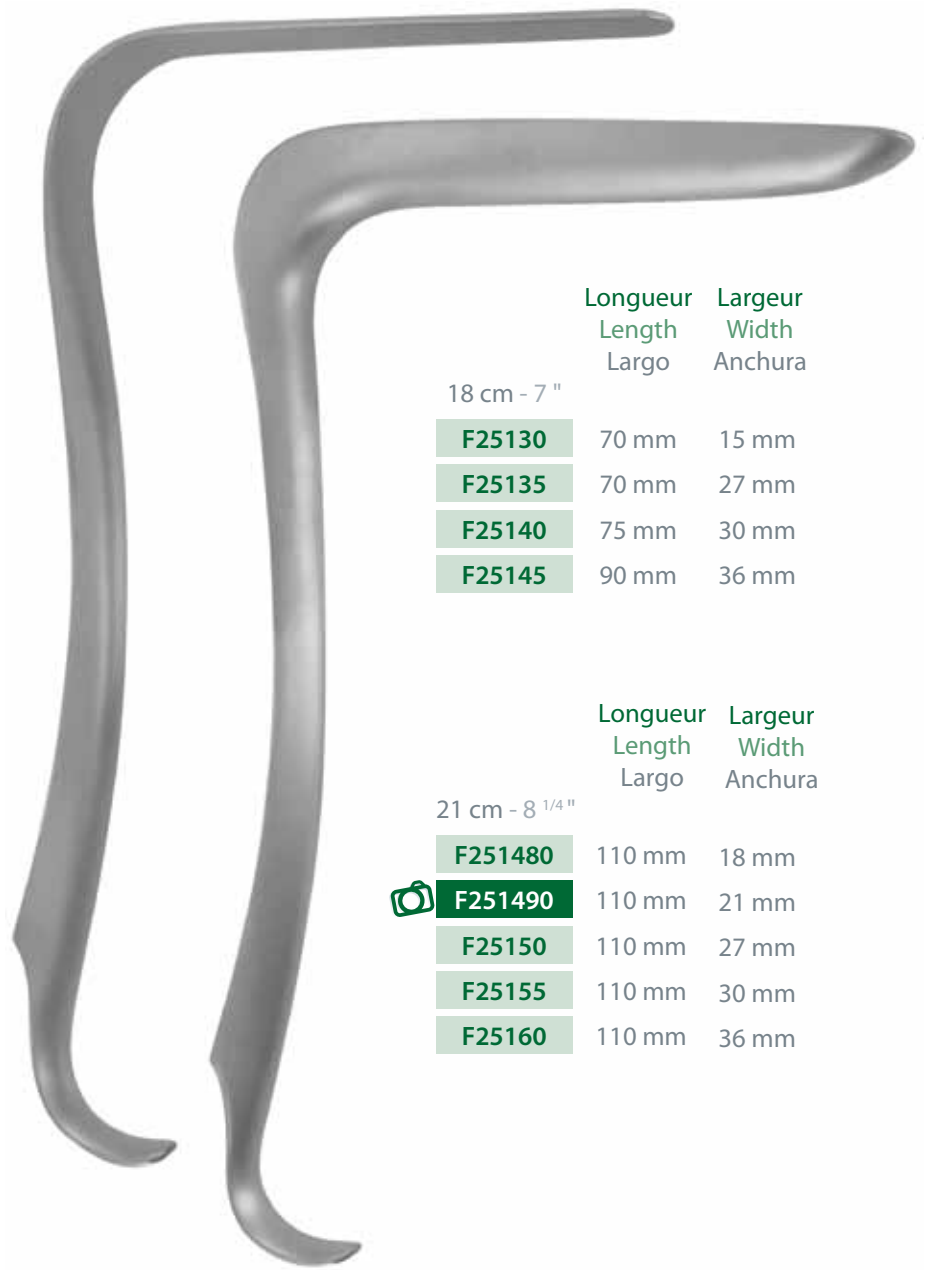

VALVE + SPECULUM
BLADE + SPECULUM
VALVULA + SPECULUM

	Longueur Length Largo	Largeur Width Anchura
18 cm - 7 "		
F25130	70 mm	15 mm
F25135	70 mm	27 mm
F25140	75 mm	30 mm
F25145	90 mm	36 mm

	Longueur Length Largo	Largeur Width Anchura
21 cm - 8 1/4 "		
F251480	110 mm	18 mm
 F251490	110 mm	21 mm
F25150	110 mm	27 mm
F25155	110 mm	30 mm
F25160	110 mm	36 mm

F251490

SIMS

A l'unité - Per unit - La unidad

	Longueur Length Largo	Largeur Width Anchura	Longueur Length Largo	Largeur Width Anchura		Longueur Length Largo	Largeur Width Anchura
	A		B				
F251631	60 mm	25 mm	60 mm	30 mm	 F251635	63 mm	32 mm
F251632	70 mm	30 mm	70 mm	35 mm	F251636	76 mm	32 mm
F251633	80 mm	35 mm	80 mm	40 mm	F251637	89 mm	38 mm

Jeux de 3 - Set of 3 - Juego de 3

 **F251630**



F251630
18 cm - 7 "



F251635
17 cm - 6 ³/₄ "

DOYEN

F251270 60 x 30 mm

 F251271 70 x 30 mm

F251272 80 x 30 mm

MATHIEU

Valve
Blade
Valva

Spéculum
Specula
Espéculo



F251271
25 cm - 10 "

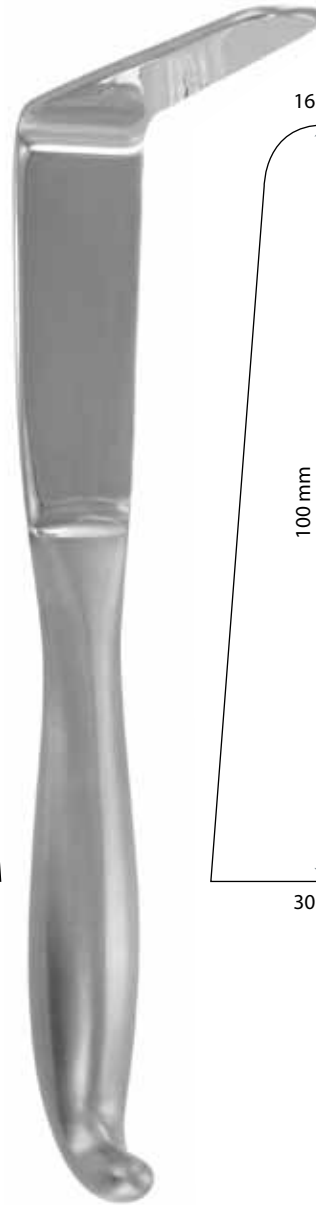
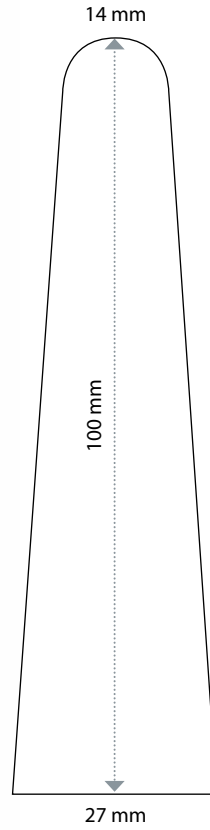

F251275
20 cm - 8 "

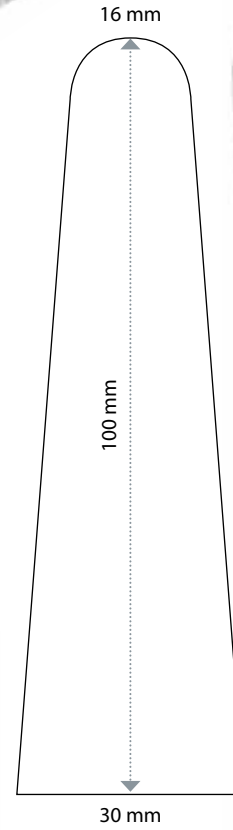

F251276
20 cm - 8 "

ST MARKS



F251261
32,5 cm - 12^{3/4} "



F251262
33 cm - 13 "



F251260
29 cm - 11^{1/2} "

JAYLE

Valve + Poids Blade + Weight Valva + Peso	Largeur Width Anchura	Longueur Length Largo
F25010	40 mm	60 mm
F25020	40 mm	90 mm



Poids seul (1000 g)
Weight only (2,2 pounds)
Peso sólo (1000 g)

Valve seule Blade only Valva sóla	Longueur Length Largo
F250110	60 mm
F250210	90 mm



F250110
18 cm - 7 "

F25025
16 cm - 6 1/4 "



AUVARD

F250265 70 x 38 mm

 **F250266** 105 x 45 mm



Poids fixe
Fixed weight
Peso fijo

F250266
23,5 cm - 9¹/₄"



 **F250260** 80 x 38 mm

F250261 105 x 42 mm

Poids démontable
Removable weight
Peso desmontable

F250260
23 cm - 9"

SCHERBAK



F250277 55 x 40/60 mm



F250278 70 x 45/70 mm



Manche seul
Handle only
Mango solo
17 cm - 6 3/4 " **F250271** 80 x 30 mm



F250274 80 x 30 mm



F250275 85 x 35 mm



F250276 90 x 40 mm



Poids seul
Weight only
Peso solo

 **F250272** 400 Gr

F250273 800 Gr



F250271



F250272



F250274



F250275



F250276



F250277



F250278

Complet - Complete - Completo **F250270** 

LANDANGER

Amnioscopes - Amnioscopes - Amnioscopo

Complet avec mandrin
Complete with mandril
Completo con mandrino



	Ø A	Ø B	L
 F15370	12 mm	24 mm	200 mm
F15380	16 mm	24 mm	200 mm
F15390	20 mm	24 mm	200 mm

Pince hystérolable - Uterine elevating forceps - Pinzas para coger el útero

COLLIN

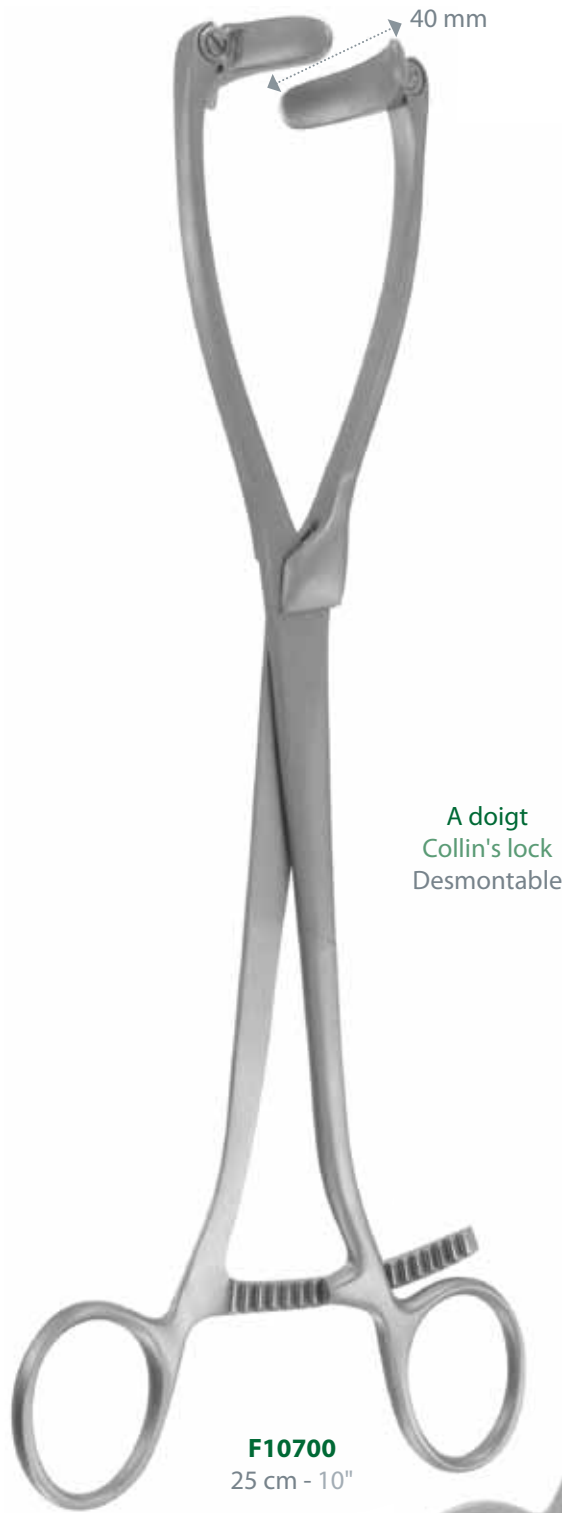

DARTIGUES



SOMMER



TARNIER

Complet
Complete
Completo

F10710
40 cm - 15 3/4 "

Tracteur seul
Traction handle only
Tractor sólo

F107105



DEMELIN-SUZOR

Système de serrage seul
Screw system only
Sistema de apreta solo



F107210

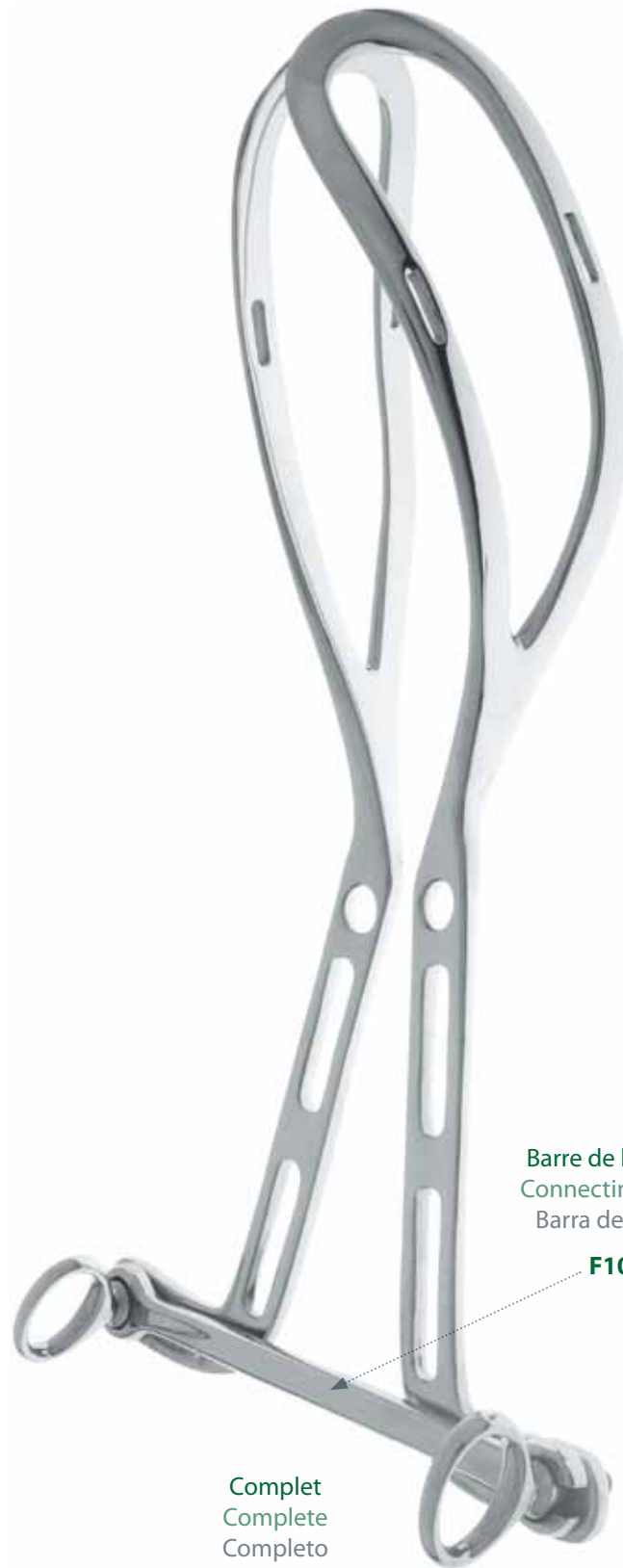

Barre de liaison seule
Connecting plate only
Barra de unión sólo

F107205

Complet
Complete
Completo

F10720
32 cm - 12 1/2"

PAJOT



F10730
36 cm - 14 1/4 "

MC LEAN



F107870
36 cm - 14 1/4 "

KIELAND



F10732
41 cm - 16 1/4 "

NAGELE

Spatules obstétricales (paire)
 Obstetrical spatulas (pair)
 Espatulas obstetricas (par)

36 cm - 14 1/4"  **F10736**

39 cm - 15 1/4" **F10735**



F107330
 40 cm - 15 3/4"



F10736
 36 cm - 14 1/4"



WRIGLEY

SIMPSON



F107220
28 cm - 11 "



F107230
23 cm - 9 "



F107240
30 cm - 12 "

LEVRET



F107250
41 cm - 16 1/4 "

SIMPSON BRAUN



F107260
36 cm - 14 "

PIPER



F107270
44 cm - 17 1/4 "

TEISSIER

Les 2 spatules sans tracteur
The 2 spatulas without traction handle
Las 2 espatulas sin tractor



F10737
31 cm - 12 1/4"

Tracteur seul
Traction handle only
Tractor sólo



F10738

SIMPSON LUIKART



F107340
36 cm - 14"

NOTTER



Perce membrane (amniotome)
Membrane punch
Perforador para la membrana

F107900
22 cm - 8 3/4 "

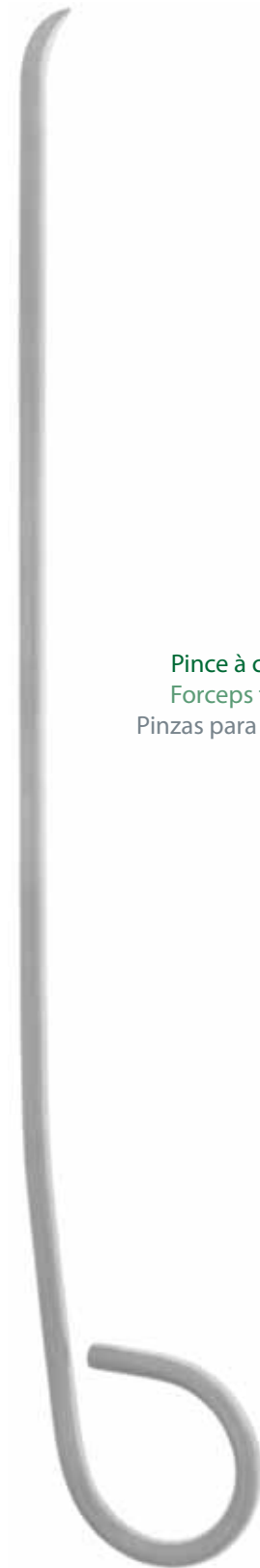

Pince à couper les clamps
Forceps to cut the clamps
Pinzas para cortar los clamps

F10800
22 cm - 8 3/4 "

BAR



F10740
8,5 cm - 3 1/3 "



F10755
15 cm - 6 "

Ventouse obstétricale - Obstetric vacuum cup - Ventosa obstétrica

Ventouse
Suction cup
Ventosa

	Ø
 F315005	30 mm
F315006	40 mm
F315007	50 mm

Diaphragme
Diaphragm
Diafragma

	Ø
 F315015	40 mm
F315016	50 mm
F315017	60 mm

Poignée de traction
Traction handle
Puñado de tracción



Lac de traction (nylon)
Vessel of traction (nylon)
Bramante de tracción (nylon)

F315021

6 brins de 1 m
6 wires of 39 1/4"
6 hilos de 1 m

3 tubes silicone
3 silicon tubs
3 tubos de silicona

 **F315022**

2 m - Ø 3 x 7 mm

Rouleau tube silicone
Roll tub silicon
Rollo tubo silicona

F315122

25 m - Ø 3 x 7 mm

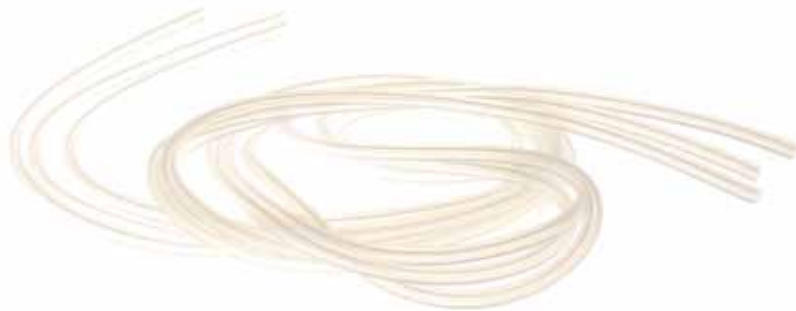

J. L. FAURE

SHUBERT

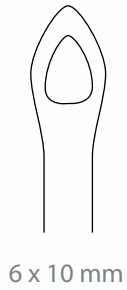

6 x 10 mm

A vis
With screw
Con tornillo

F20160
25 cm - 10 "



4,5 x 8 mm

F20165
26 cm - 10 1/4 "

VAN DOREN

SCHUMACHER

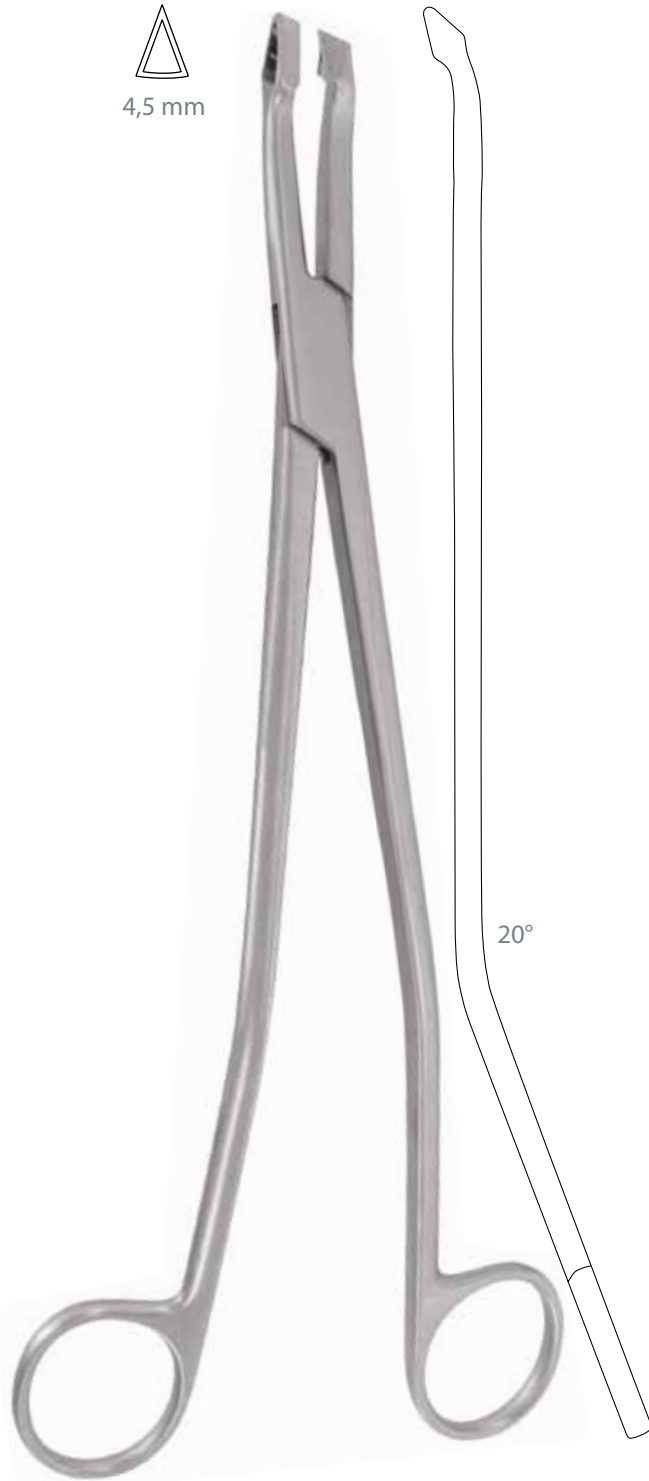
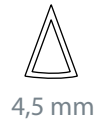

F201655
24 cm - 9 1/2 "

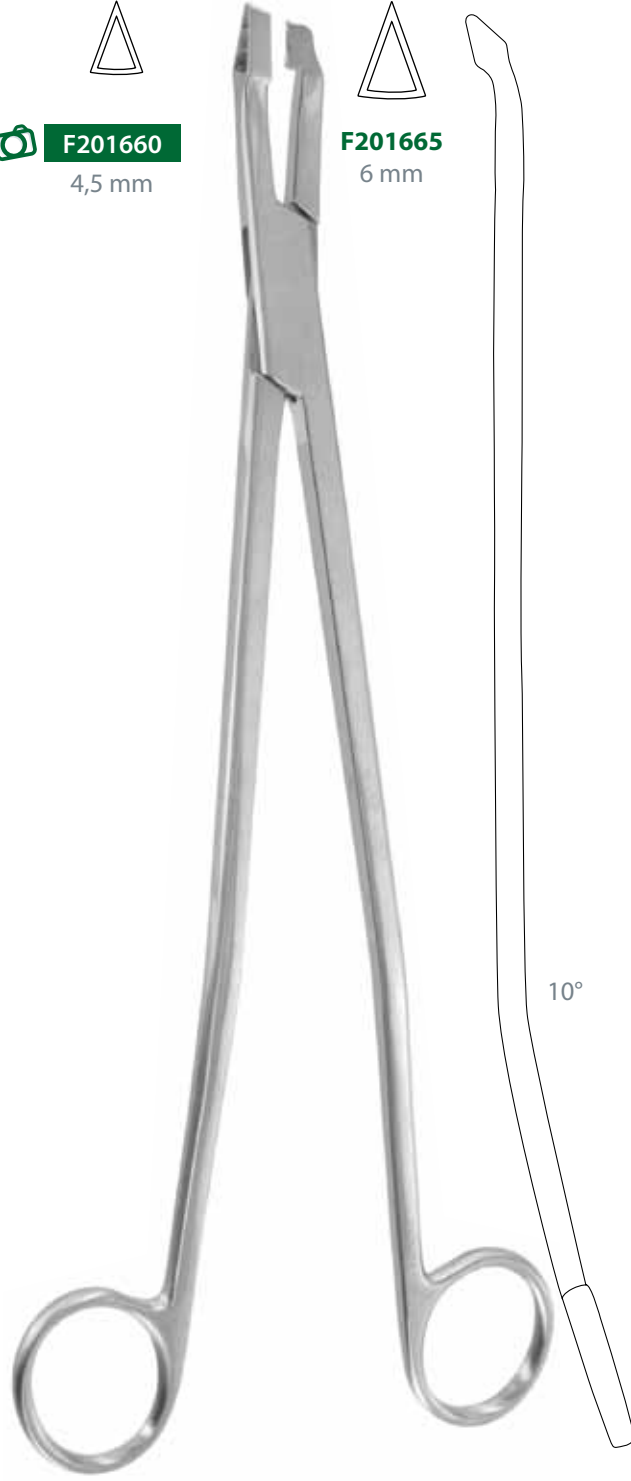

F201660
24 cm - 9 1/2 "



LANDANGER

Pinces à biopsie - Biopsy forceps - Pinzas para biopsia

LANDANGER

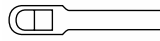

Mors
Jaws
Bocas

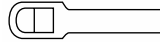
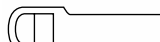
	25 cm - 10" 	F20300	2 x 6 mm
	25 cm - 10"	F20295	3 x 8 mm
	25 cm - 10"	F20290	4 x 8 mm

TISCHLER-MORGAN



Mors
Jaws
Bocas

	20 cm - 7 3/4"	F200050	3 x 7 mm
---	----------------	----------------	----------

BABY-TISCHLER (MINI-TOWNSEND)



Mors
Jaws
Bocas

	21 cm - 8"	F200060	2,3 x 4 mm
---	------------	----------------	------------

LANDANGER

Pinces à biopsie - Biopsy forceps - Pinzas para biopsia

DOUAY

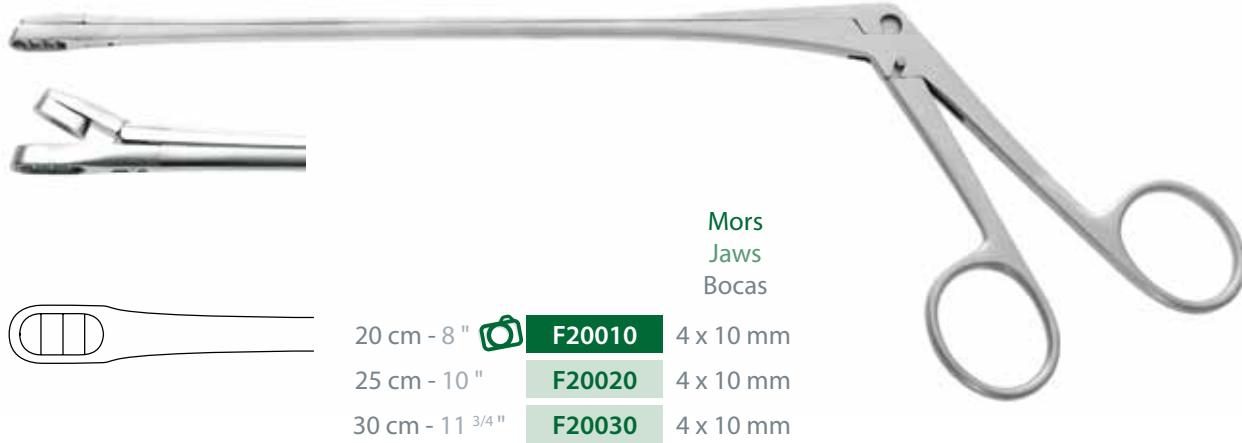

BERGER



SCHUMAKER

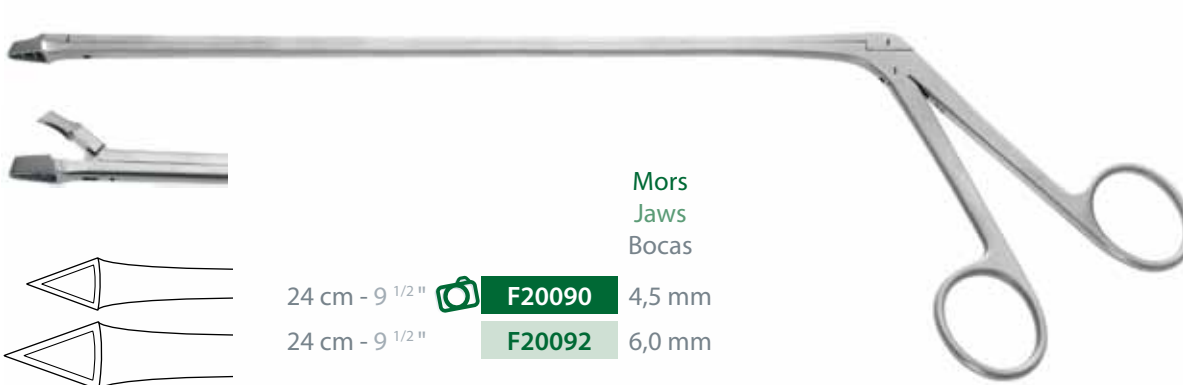

Pinces à biopsie - Biopsy forceps - Pinzas para biopsia

PATTERSON

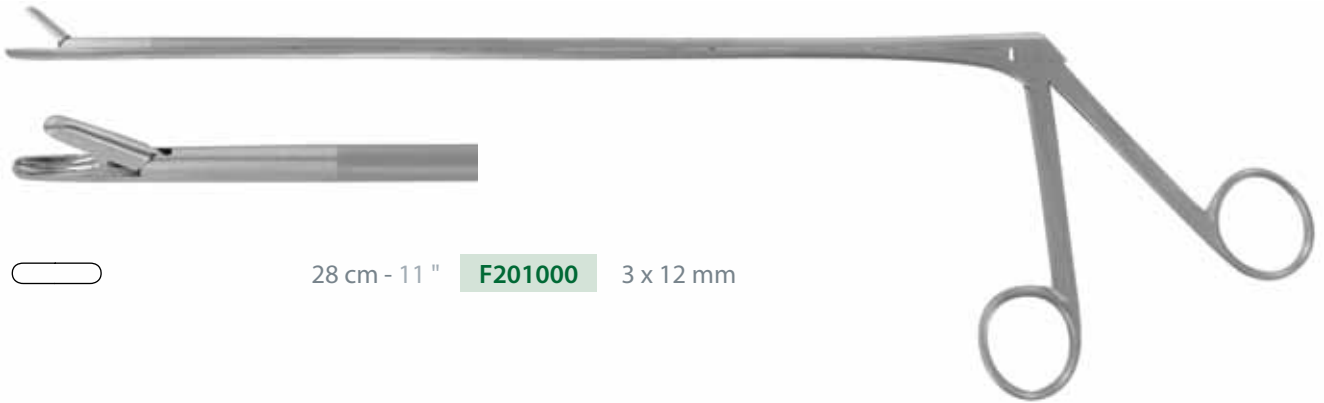

28 cm - 11 " **F201000** 3 x 12 mm

KEVORKIAN



23 cm - 9" **F201010** 3 x 10 mm

EPPENDORF

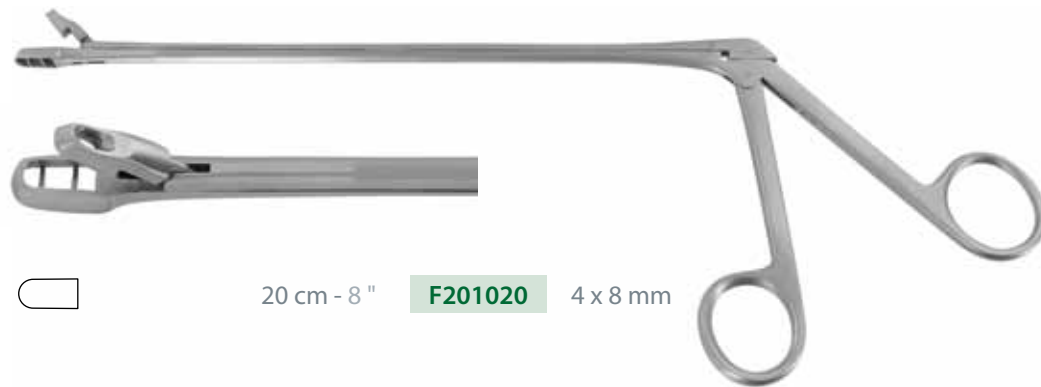

20 cm - 8" **F201020** 4 x 8 mm

TOWNSEND

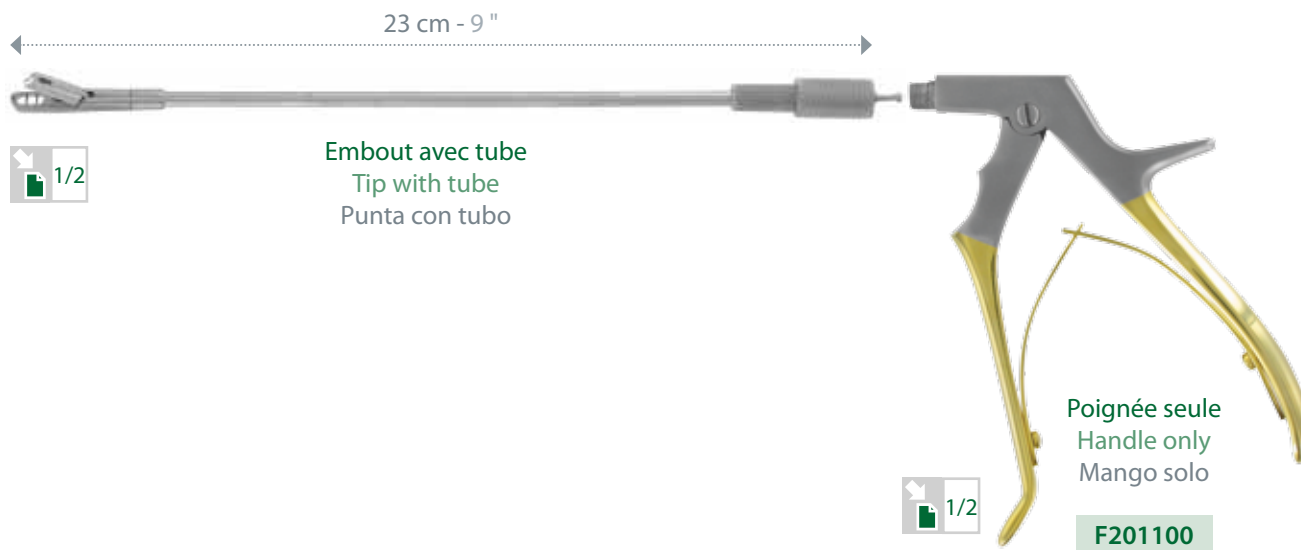

TISCHLER



KEVORKIAN



MINI TOWNSEND



GOURDET

Mousse
Blunt
Roma



F30180
26 cm - 10 1/4"

F30170

4 mm



F30180

6 mm



F30190

8 mm



F30200

10 mm



F30210

12 mm

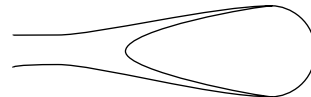

F30220

14 mm

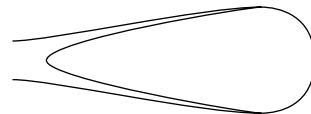

F30230

16 mm

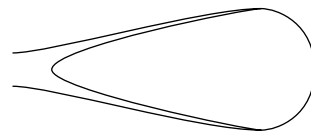

WALLICH

Mousse
Blunt
Roma



35 cm - 13 3/4"  **F30245**

12 mm

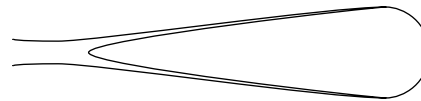

35 cm - 13 3/4" **F30250**

40 cm - 15 3/4" **F30280**

14 mm

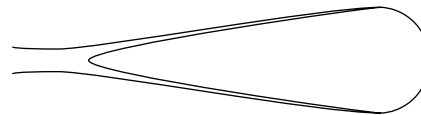

35 cm - 13 3/4" **F30260**

40 cm - 15 3/4" **F30290**

17 mm

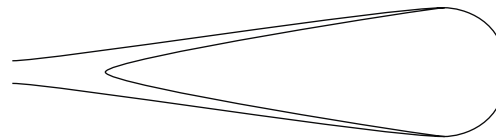

35 cm - 13 3/4" **F30270**

40 cm - 15 3/4" **F30300**

20 mm

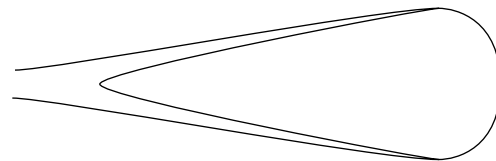

F30245

35 cm - 13 3/4"



SIMON

Tranchante
Sharp
Cortante

Double courbure
Double curvature
Doble curvatura



F30010
27 cm - 10 ³/₄ "



F30010

4 mm



F30015

6 mm



F30020

8 mm

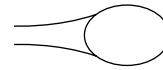

F30030

10 mm

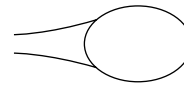

F30040

12 mm

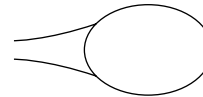

F30050

14 mm

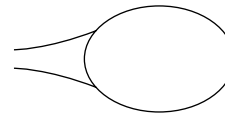

F30060

16 mm

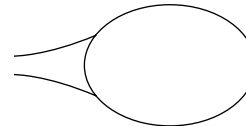

F30070

18 mm

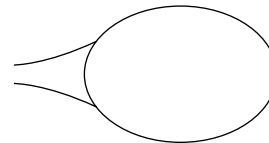

VOLKMANN

Tranchante
Sharp
Cortante



F30340
28 cm - 11"



F30340

3 mm

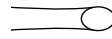

F30350

6 mm



F30360

8 mm

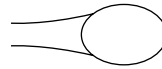

F30370

10 mm

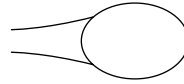

F30380

12 mm

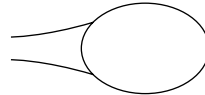

F30390

14 mm

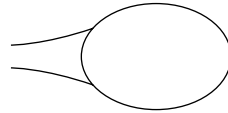

SCHRÖDER

Tranchante
Sharp
Cortante



F303913
30 cm - 12 "

SIMON

Tranchante
Sharp
Cortante



F303922
25 cm - 10 "

F303911

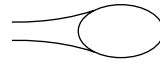

N° 1 - 7,0 mm

F303921

F303912

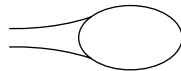

N° 2 - 8,5 mm

F303922

F303913

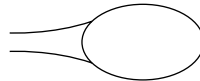

N° 3 - 10,0 mm

F303923

F303914

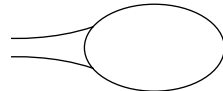

N° 4 - 11,5 mm

F303924

F303915

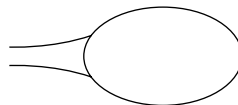

N° 5 - 13,0 mm

F303925

F303916

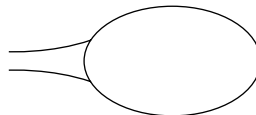

N° 6 - 14,5 mm

F303926

LANDANGER

Curettes utérines - Uterines curettes - Curetas uterinas

SIMS



F30130
28 cm - 11 "

Tranchante Sharp Cortante	Mousse Blunt Roma		
F30080	F300801	3 mm	
F30090	F300901	4 mm	
F30100	F301001	5 mm	
F30110	F301101	6 mm	
F30120	F301201	8 mm	
 F30130	F301301	10 mm	
F30140	F301401	12 mm	
F30150	F301501	14 mm	
F30160	F301601	16 mm	

RECAMIER

Tranchante
Sharp
Cortante

Mousse
Blunt
Roma

F30311 **F30332**  N° 00 - 5 mm

F30312 F30333 N° 01 - 7 mm

F30313 F30334 N° 03 - 9 mm

F30314 F30335 N° 05 - 12 mm

F30316 F30336 N° 06 - 14 mm

F30317 F30337 N° 08 - 16 mm

F30319 F30338 N° 09 - 19 mm

F303200 F303382 N°11 - 21 mm

F303210 F303383 N° 12 - 23 mm

Tranchante
Sharp
Cortante

Mousse
Blunt
Roma

F303220 **F303385**

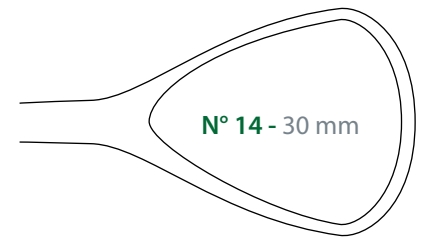

F303230 **F303386**



F303240 **F303387**

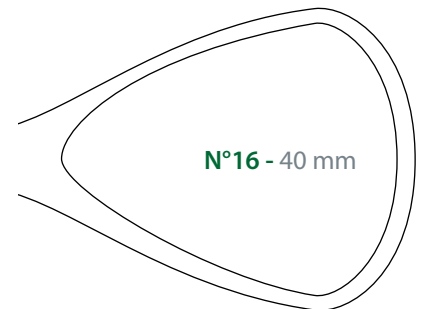

F30332
31 cm - 12 1/4"

CUZZI

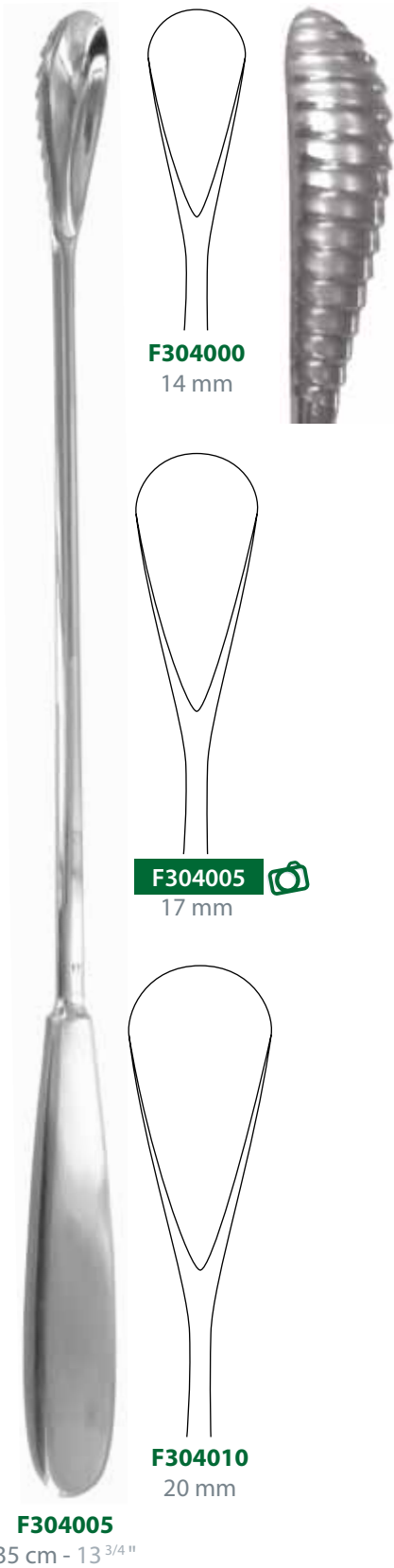

HEANEY



PIRON



POZZI

BLAKE

Tranchant
Sharp
Cortante

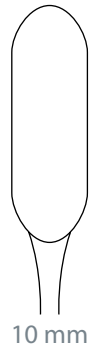

10 mm

F304050
26,5 cm - 10 1/2 "

Tranchante
Sharp
Cortante



8 mm

F304065 
6 x 8 mm



6 mm

F304060
4 x 6 mm

6 mm 4 mm

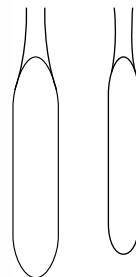

Tranchante
Sharp
Cortante

F304065
31 cm - 12 1/4 "

Mousse
Blunt
Roma

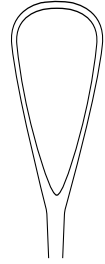

12 mm

Tranchante
Sharp
Cortante

F304070
27,5 cm - 10 1/4 "

8 mm

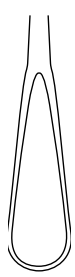

KEVORKIAN



F304130
30 cm - 12 "



F304140
30 cm - 12 "



F304106
28 cm - 11 "

- F304104** ø 4 mm
- F304106** ø 6 mm
- F304108** ø 8 mm
- F304110** ø 10 mm
- F304112** ø 12 mm
- F304114** ø 14 mm

Raccord pour aspiration
Connector for suction
Accesorio de succión



F304120
11cm - 4 1/2 "

MARTIN



F10805
34 cm - 13 1/2 "

BRIESKY



F10810
33 cm - 13 "

SCHULTZE

Instruments pour hystéro-salpingographie
Instruments for hystero-salpingography
Instrumentos para histero-salpingografía



Complet
Complete
Completo
F304160

Sans manomètre
Without manometer
Sin manometro
F304170

BRAUN

Dépresseur utérin
Uterin depressor
Depresor uterino



F304150
28 cm - 11 "

NOVACK

POZZI CHERON

INSTRUMENTS POUR HYSTÉROGRAPHIE
INSTRUMENTS FOR HYSTEROGRAPHY
INSTRUMENTOS PARA HISTEROGRAFIA



F30420
24 cm - 9 1/2"
Ø 4 mm



F30435
22 cm - 8 3/4"
Ø 5 mm



F304300
16 cm - 6 1/4"
Ø 20 mm / 20 cc

Joint pour l'embout
Seal for nozzle
Junta para contera



F304322

Joint du piston
Piston seal
Junta de piston



F304321



A doigt
Collin's lock
Desmontable

A crochets
With hooks
Con ganchos

F30455
24 cm - 9 1/2"

CIRCERON (MATHIEU)



F107055
36 cm - 14 1/4"

Pinces pour retirer les fils de stérilet
Forceps to take out the wire of coil
Pinzas para sacar los hilos de espiral

THERUM

F107050
27 cm - 10 3/4"

IVG

Manche à raccord tournant pour canule IVG
Handle with rotating connection for IVG cannula
Mango a racor rotativo para canula IVG



Ø 10 - 15mm

F305000
13,5 cm - 5 1/4"



DOYEN



Tracteurs pour fibrome
Mioma screw
Tirabuzone para fibroma

F10780
22 cm - 8 3/4"

HEGAR

PALMER

Modèle simple
Simple model
Modelo simple



F36160
18 cm - 7 "

	Ø		Ø
F36010	1 mm	F36015	1,5 mm
F36020	2 mm	F36025	2,5 mm
F36030	3 mm	F36035	3,5 mm
F36040	4 mm	F36045	4,5 mm
F36050	5 mm	F36055	5,5 mm
F36060	6 mm	F36065	6,5 mm
F36070	7 mm	F36075	7,5 mm
F36080	8 mm	F36085	8,5 mm
F36090	9 mm	F36095	9,5 mm
F36100	10 mm	F36105	10,5 mm
F36110	11 mm	F36115	11,5 mm
F36120	12 mm	F36125	12,5 mm
F36130	13 mm	F36135	13,5 mm
F36140	14 mm	F36145	14,5 mm
F36150	15 mm	F36155	15,5 mm
F36160	16 mm	F36165	16,5 mm
F36170	17 mm	F36175	17,5 mm
F36180	18 mm	F36185	18,5 mm
F36190	19 mm	F36195	19,5 mm
F36200	20 mm		
F36210	21 mm		
F36220	22 mm		
F36230	23 mm		
F36240	24 mm		
F36250	25 mm		
F36260	26 mm		
F362610	27 mm		
F362620	28 mm		
F362630	29 mm		
F362640	30 mm		



F366012
23 cm - 9 "

	Ø
F366006	1 x 2 mm
F366009	2 x 3 mm
F366012	3 x 4 mm
F366015	4 x 5 mm
F366018	5 x 6 mm
F366021	6 x 7 mm
F366024	7 x 8 mm
F366027	8 x 9 mm
F366030	9 x 10 mm
F366033	10 x 11 mm
F366036	11 x 12 mm

Dilatateurs utérins - Uterine dilators - Dilatadores uterinos



Boîte complète de 4 à 17 mm
Complete case from 4 to 17 mm
Caja completa de 4 a 17 mm

 **F36270**

Boîte seule
Box only
Caja sóla

F36275 205 x 105 x 55 mm



Boîte complète de 1 à 26 mm
Complete case from 1 to 26 mm
Caja completa de 1 a 26 mm

 **F36280**

Boîte seule
Box only
Caja sóla

F36285 310 x 200 x 60 mm

Dilatateurs utérins - Uterine dilators - Dilatadores uterinos

HEGAR

Modèle double
Double model
Modelo doble



F36440
20 cm - 8 "

HANK

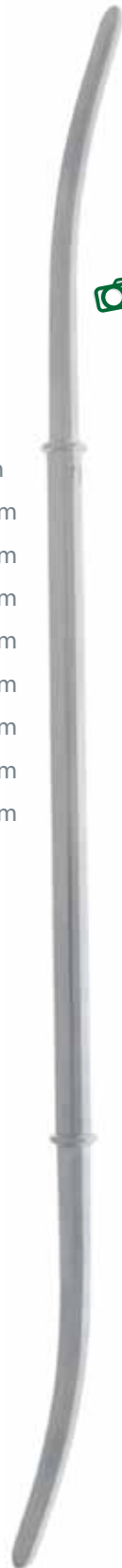

- | | Ø |
|----------------|-------------|
| F365050 | 4,5 x 5 mm |
| F365060 | 5,5 x 6 mm |
| F365070 | 6,5 x 7 mm |
| F365080 | 7,5 x 8 mm |
| F365090 | 8,5 x 9 mm |
| F365100 | 9,5 x 10 mm |

F365050
27,5 cm - 10 3/4 "

PRATT



- | | Ø |
|----------------|----------------|
| F365200 | 4,5 x 5,0 mm |
| F365201 | 5,6 x 6,3 mm |
| F365202 | 7,0 x 7,6 mm |
| F365203 | 8,3 x 9,0 mm |
| F365204 | 9,6 x 10,3 mm |
| F365205 | 11,0 x 11,6 mm |
| F365206 | 12,3 x 13,0 mm |
| F365207 | 13,6 x 14,3 mm |

F365203
28 cm - 11 "

Hysteromètres - Uterine sounds - Hysterómetros

VALLEIX



Curseur seul
Cursor alone
Cursor solo



F36310

F36300
28 cm - 11 "

SIMS



Rigide
Rigid
Rigido

F36315 

Malléable
Malleable
Maleable

F363155

F36315
32 cm - 12 1/2 "

MARTIN (SIMPSON)



F363200
32 cm - 12 1/2 "

GUYON

Cathéter courbe (beniqué)
Curved dilating bougie
Bujia dilatadora curva

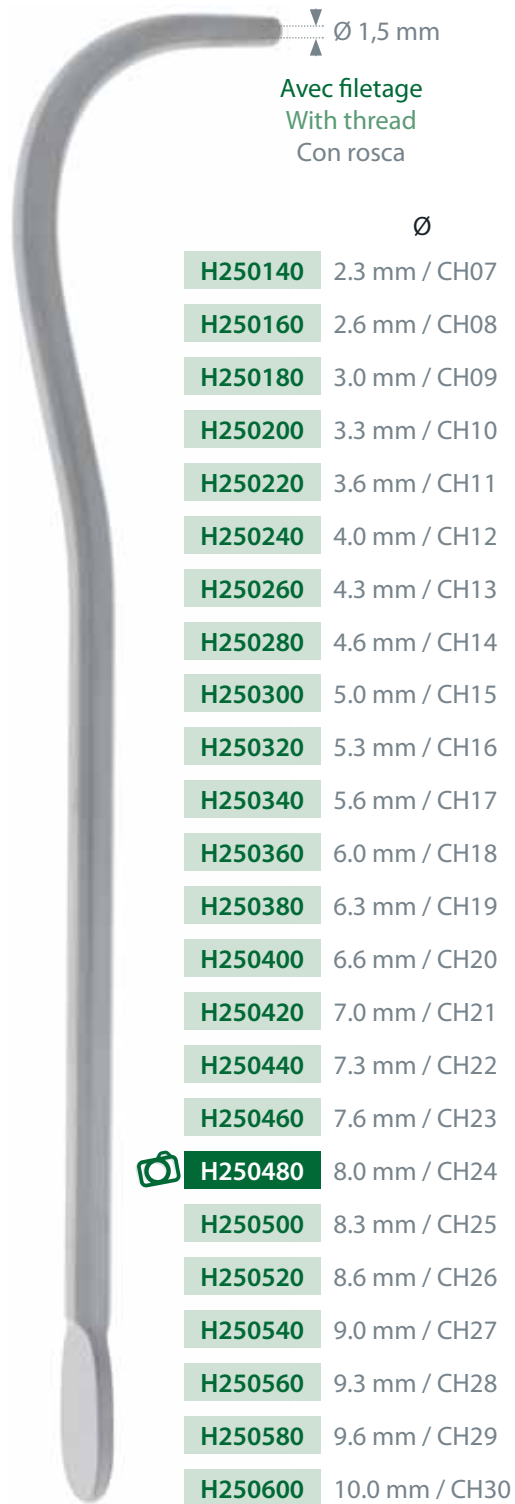

H250480
27 cm - 10^{3/4}"

Sondes métalliques
Metal catheters
Sondas metálicas



H251012
25 cm - 10"

H251112
15 cm - 6"

STRAUSS

Compresseur de l'urètre
Urethra compressor
Compresor para uretra



H20110-0
10,5 cm - 4^{1/8}"

PRATT



F153510
20,5 cm - 8"

MATHIEU



F153520
19,5 cm - 7^{3/4}"

TRELAT



F15340
20 cm - 8"

Avec crémaillère	Sans crémaillère
With rack	Without rack
Con cremallera	Sin cremallera

 F15340	F15350
---	---------------

CZERNY

23 x 106 mm



F153540
22 cm - 8³/₄ "

- F153626** 60 mm
- F153628** 80 mm
- F153630** 125 mm



F153628
22 cm - 8³/₄ "

SIMS

18 x 80 mm



F153610

18 x 80 mm



F153620
15 cm - 6 "

KELLY

Proctoscope
Proctoscope
Proctoscopio

F153350 22 x 100 mm

 **F153351** 22 x 140 mm

F153352 22 x 200 mm



F153351

Sphinctéroscope
Sphincteroscope
Esfinteroscopio

F153340 21 x 50 mm

 **F153341** 27 x 50 mm



F153341

BENSAUDE

Anuscope
Anuscope
Anuscopio

F15310 19 x 70 mm

 **F15320** 22 x 70 mm



F15320
18 cm - 7"

BARR



22 x 70 mm

B80885
17 cm - 6 3/4"

HALLE



20 x 80 mm

F153360
9 cm - 3 1/2"

ALAN PARKS

Avec 2 paires de valves latérales et 1 valve médiane
 With 2 pairs of lateral blades and 1 center blade
 Con 2 pares de Valvas laterales y 1 valva mediana

B80880

50 mm

Valves latérales (paire)
 Lateral blades (pair)
 Valvas laterales (par)

95 x 24 mm



B808850

75 x 24 mm



B808851

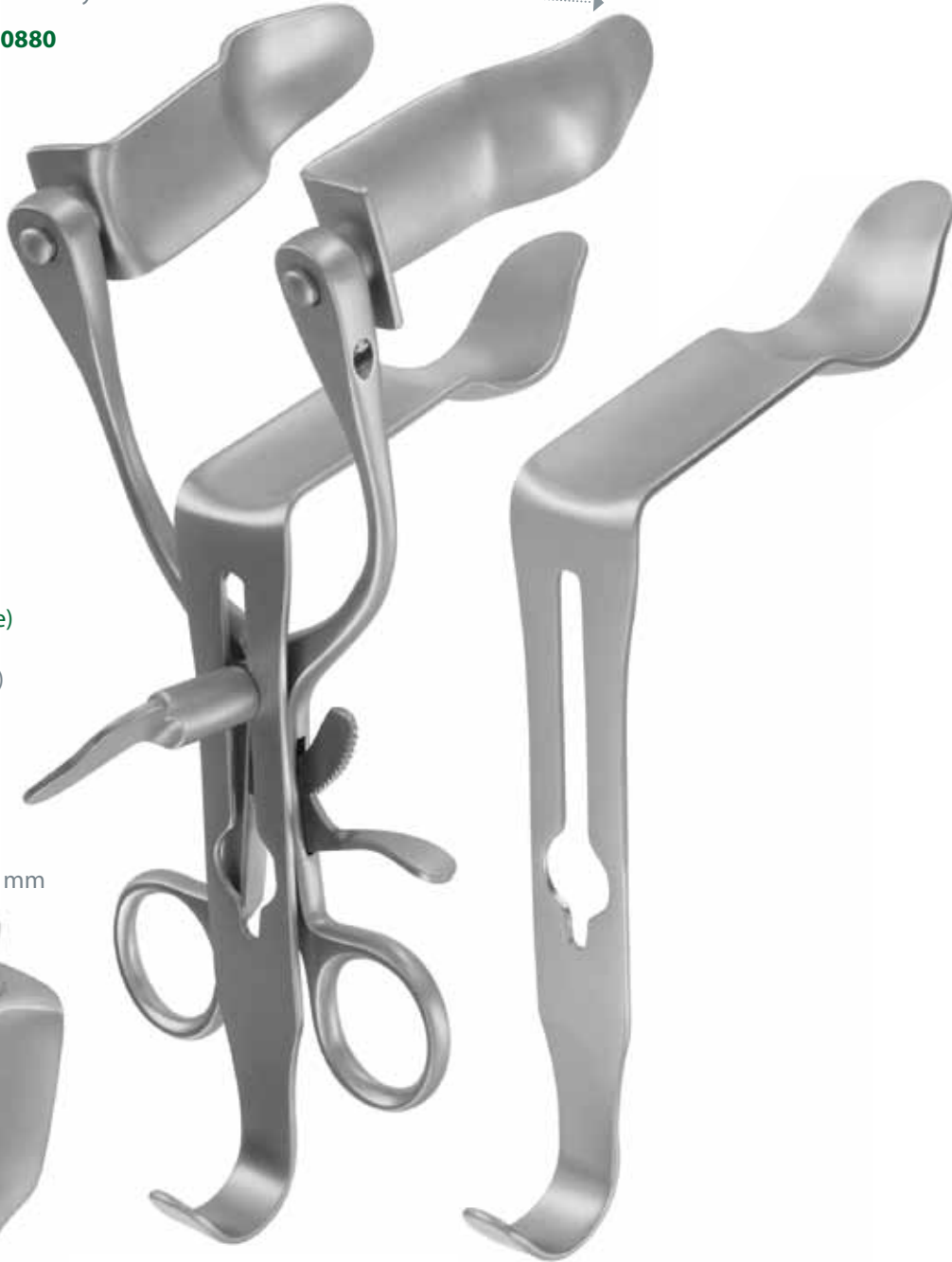

Valve médiane seule
 Central blade only
 Valvas mediana solas

95 x 24 mm

B808852

Pinces à biopsie rectale - Rectal biopsy forceps - Pinzas para biopsia rectal

YEOMAN

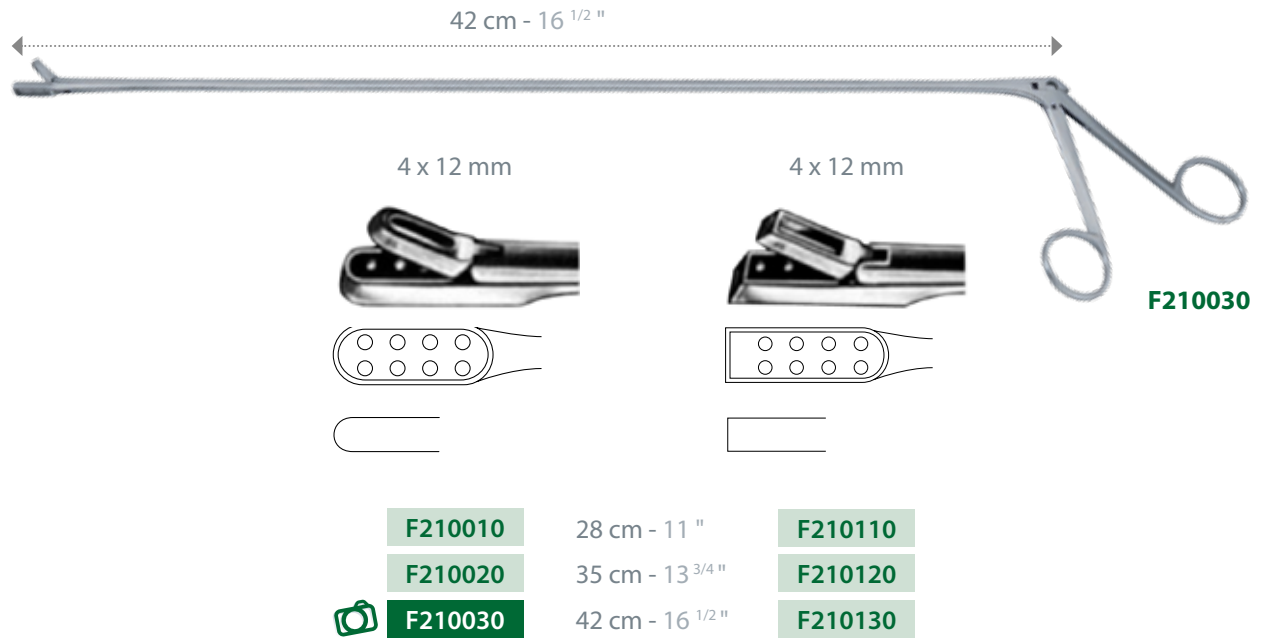

Rotative - Turntable - Giratorio



MC GIVNEY



RUDD

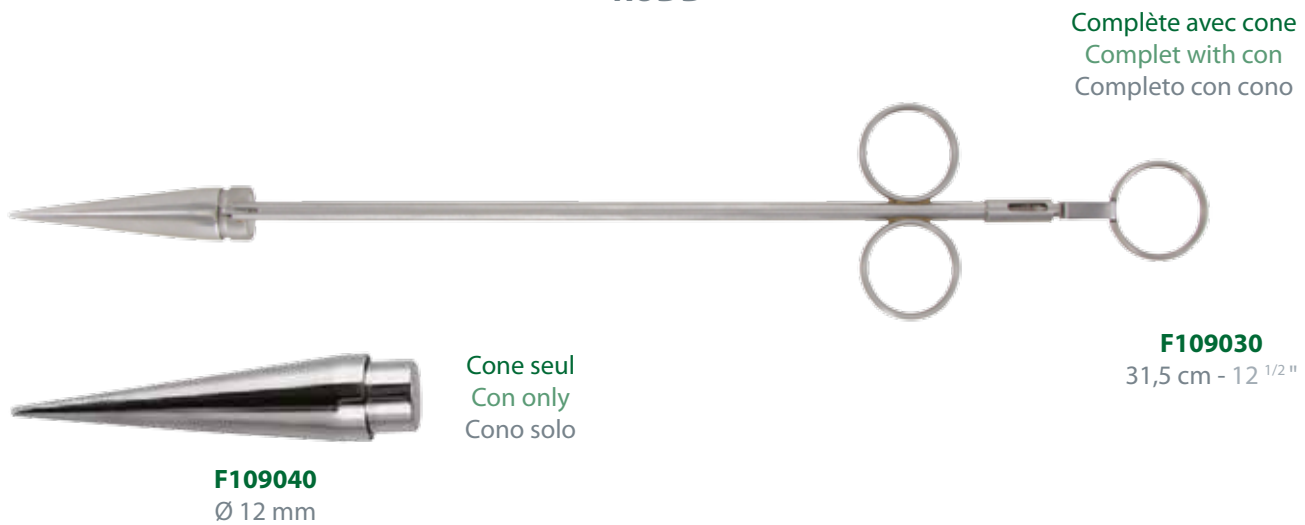

Bague caoutchouc pour ligature, paquet de 100
Ligature rubber ring, box of 100
Arandelas de goma par ligadura, caja de 100



F109020
Ø 6 mm

HEYWOOD SMITH



A vis
With screw
Con tornillo

F109200
20 cm - 8 "

F109210
21 cm - 8 1/4"

MC GIVNEY



F109220
19 cm - 7 1/2"

METZENBAUM



B256770
28 cm - 11 "

MILLIN

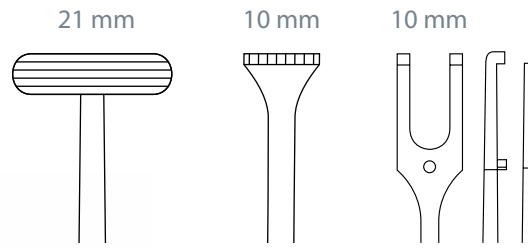

H10140
23 cm - 9 "

H10145
23 cm - 9 "

H10150
23 cm - 9 "



H10140
23 cm - 9 "

O'SHAUGNESSY



B606090
30 cm - 12 "

SANTORINI



B953000
20 cm - 8 "

YOUNG

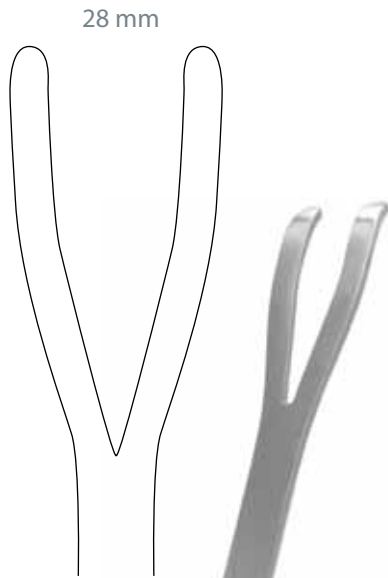

B804600
36 cm - 14 "



B804620
21 cm - 8 1/4 "



B804610
22 cm - 8 3/4 "

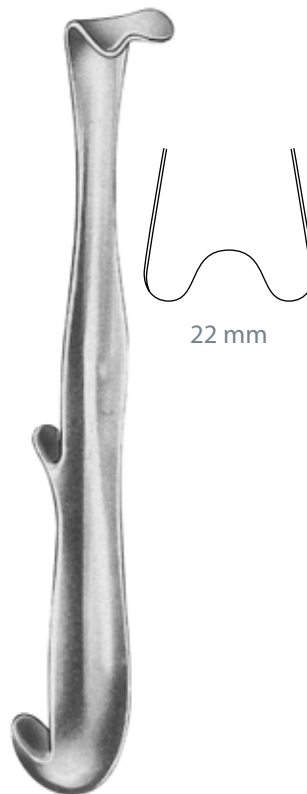

B804630
21 cm - 8 1/4 "

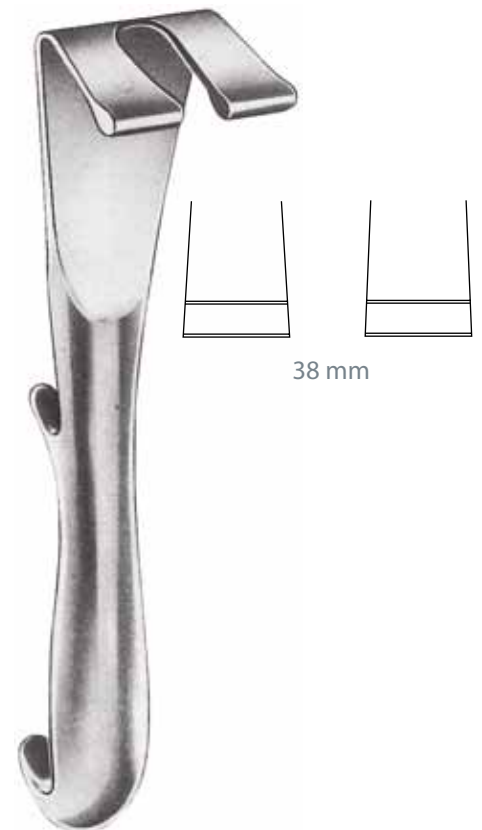

B804640
22 cm - 8 3/4 "